

PLASTERING
PLAIN & DECORATIVE.

—
MILLAR
—

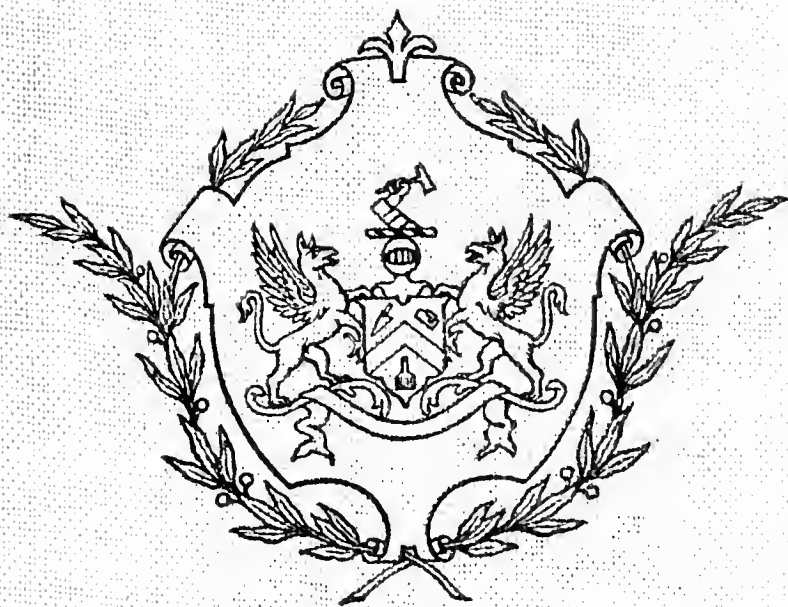

UNIV. OF CALIF. LIBRARY, LOS ANGELES

*LIBRARY OF
ARCHITECTURE AND
ALLIED ARTS*

Gift of

The Heirs
of
F. Germain Hubby, A.I.A.

WIV.



PLASTERING
PLAIN AND DECORATIVE.

INDEX TO ADVERTISERS.

	PAGE
ADIE, PATRICK	VII.
ASBESTOS AND ASBESTIC Co., Lt. (The)	I.
BATSFORD, B. T.... ..	XVI.
BAXTER, R., & Co.	XIV.
BICKLEY, JOSEPH	VI.
CAFFERATA & Co.	III.
DE JONG, F., & Co.	XIII.
DREW, W. G.	XIII.
FORD, PEIER, & SONS	XIV.
GILCHRIST, ALEXR.	XV.
HALL, JOHN	XII.
HARBUTT WILLIAM	XII.
HOBMAN, A. C. W., & Co.	XIV.
HOWE, JOHN, & Co	II.
ILLUSTRATED CARPENTER AND BUILDER (The)	XV.
JONES, FRED., & Co.	X.
LATTO, A. F., & Co.	XIV.
MURAL AND DECORATIONS SYNDICATE, Lt. (The)	XI.
MILLAR, W.	XVI.
NELSON, GEO., DALE & Co., Lt.	XIII.
PATENT INDURATED STONE Co., Lt. (The)	IX.
ROBINSON, JOSEPH, & Co., Lt.	V.
ROME, GEORGE, & Co.	XI.
RULE, JOHN	VI.
SALTER, GEO., & Co.	VIII.
SUBWEALDEN GYPSUM Co., Lt. (The)	IV.
TYZACK, SAMUEL	XV.
WILSON, J., & SON	XIII.
YOUNG, B., & Co.	X.



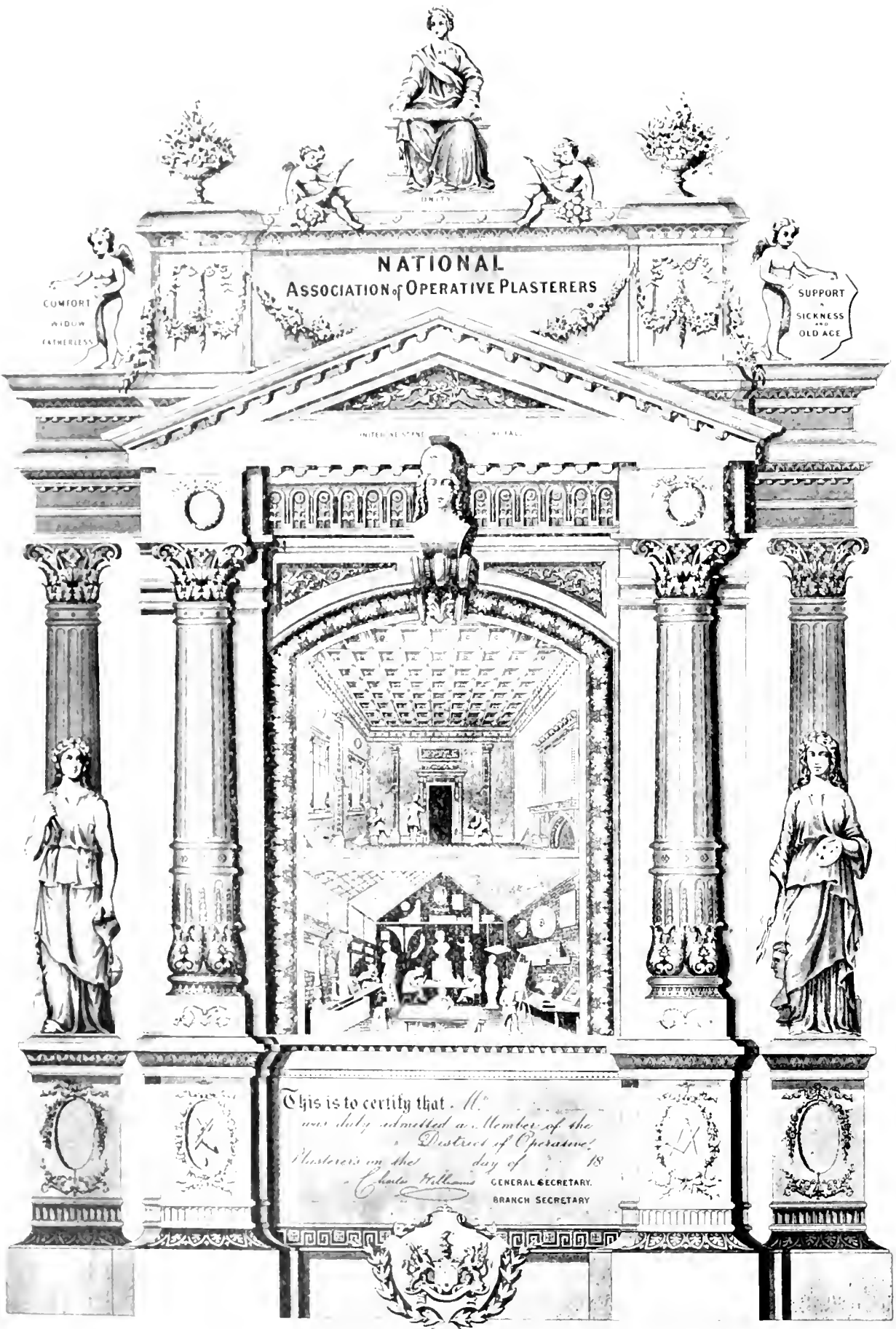

NATIONAL
ASSOCIATION of OPERATIVE PLASTERERS



UNITED STATES OF AMERICA

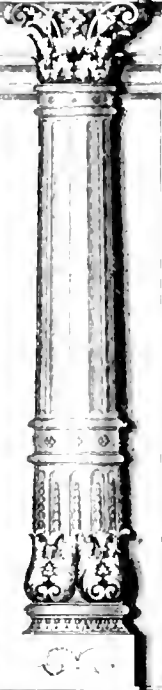
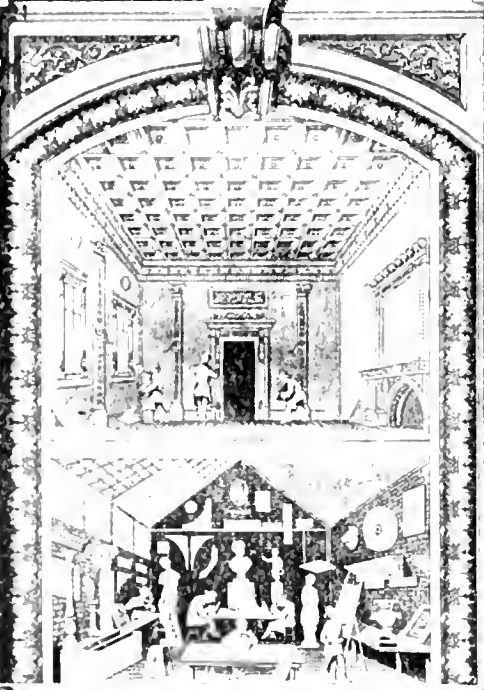

This is to certify that *N^o*
was duly admitted a Member of the
District of Operative
Plasterers on the day of 18
Charles Williams GENERAL SECRETARY.
BRANCH SECRETARY



PLASTERING

PLAIN AND DECORATIVE.

A PRACTICAL TREATISE ON THE ART & CRAFT OF
PLASTERING AND MODELLING.

INCLUDING FULL DESCRIPTIONS OF THE VARIOUS TOOLS, MATERIALS, PROCESSES,
AND APPLIANCES EMPLOYED; ALSO OF MOULDED OR "FINE" CONCRETE AS USED
FOR FIREPROOF STAIRS AND FLOORS, PAVING, ARCHITECTURAL DRESSINGS, &c. &c.

TOGETHER WITH AN ACCOUNT OF
HISTORICAL PLASTERING IN ENGLAND, SCOTLAND, AND IRELAND,
ACCOMPANIED BY NUMEROUS EXAMPLES.

BY

WILLIAM MILLAR,
PLASTERER AND MODELLER.

WITH AN INTRODUCTORY CHAPTER ENTITLED "A GLIMPSE OF ITS HISTORY,"
By G. T. ROBINSON, Esq., F.S.A.

THE WHOLE FULLY ILLUSTRATED WITH FIFTY-TWO FULL PAGE PLATES, AND TWO HUNDRED AND
THIRTY-ONE SMALLER ILLUSTRATIONS (comprising over Five Hundred Figures) IN THE TEXT.

LONDON: B. T. BATSFORD.

NEW YORK:

TRUSLOVE, HANSON & COMBA, LTD.,

67 FIFTH AVENUE.

1899.

A PREFATORY NOTE.



MR MILLAR has asked me to say for him that which he finds somewhat difficult to say for himself, and I think the simplest way of doing this will be to explain in the fewest possible words, how and why we made each other's acquaintance and what came of it. In 1891 I read a lecture on "Decorative Plaster Work" at the Society of Arts, a subject in which I felt much interest, and one on which I had previously written and spoken. To this lecture Mr Millar came, and shortly afterwards sought me, telling me of his craft-work, and of his proposed book on Plastering, upon which he had then been long engaged. For this he asked for such literary help as I could give him. I found in him a craftsman who delighted in his craft, and one who, whilst yet in his 'prentice days, finding that, unlike most other handicrafts, plastering had no text-book or manual, set before himself the ambition of writing one. Following his father's wholesome advice (himself a plasterer, and a descendant of a long line of plasterers), he set himself to "learn his trade first," but whilst doing this, he kept collecting facts, and laying the foundation of the work he has at length achieved. Fortunately he had, what is becoming in these versatile days, the *rare* advantage of a rigorous apprenticeship, and bettered his instruction by learning more, and working through the United Kingdom, even extending the sphere of his labour to Paris. Keeping his eyes open, he acquired a very extended knowledge of the direct ways of his trade, and taking notes of all the processes he came in contact with, he accumulated an extensive craft knowledge in the byways of it. These he extended by well-directed reading, and better still by observation, and reasoning upon what he learnt; inventing new methods, trying new materials, viewing both sides of the questions of the trade, now as workman and now as master, until he thoroughly fitted himself for the task he never lost sight of, and about 1880 commenced formulating his book. And now troubles came upon him—ill-health, misfortune, domestic afflictions, and last of all a fire, which not only bereft him of house and home, but burnt his treasured manuscripts and drawings, and all he had written for his book. But Mr Millar, like a true Scot, without repining at the inevitable, set to work again, re-wrote his manuscript and re-made his drawings. Even yet an envious fate pursued him, for after making arrangements for their publication, and after they had been for many months in the hands of his intended publisher, that gentleman failed, without having made any progress with the production of the book.

Prefatory Note.

The present publisher having undertaken to bring his book before the world, Mr Millar has carefully gone through the manuscript again, altering it, adding to it, and bringing it quite up to date. As for me, I have simply revised it for the press, in fulfilment of a promise I made long ago, finding, however, no alteration needed in the technical portion. Only in the first chapter have I made anything beyond verbal alteration, and that as small as possible, leaving Mr Millar to describe in his own language the processes he is so thoroughly familiar with. For the historical *résumé* he had accumulated an immense amount of matter, from which I have freely drawn, supplementing it by other information learned from my own studies, and chronologically arranging both; but the value of the work is entirely due to his own labours, and I heartily congratulate him on its final achievement after such arduous struggles. I wish it all the success his perseverance deserves and its thoroughness should command, and I trust that such success may encourage other craftsmen to write their own "shop knowledge" as intelligently and as intelligibly as Mr Millar has here done that of plaster work. To his own craft it is a life's legacy; to the younger members, it will be an invaluable text-book; to the elder ones, a permanent pleasure. To my own profession, and to all others interested in so useful and so decorative a pursuit, it will prove a lasting book of constant reference.

GEO. T. ROBINSON.

LONDON, 20th February 1867.

AUTHOR'S PREFACE.

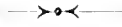

AS kindly set forth in the "Prefatory Note," by Mr G. T. Robinson, to whom I desire here to record my deep indebtedness and warmest thanks for much valuable help and encouragement, the present volume is the outcome of a long-cherished idea pursued to its fulfilment. So far back as the time of my apprenticeship—when attending the classes of the Edinburgh School of Arts—the need of a practical book on Plastering and Modelling was greatly felt. It was thought remarkable that although many books, varying in size and in degrees of merit, dealing with other branches of the building trades, were in use, no such book existed on this ancient and honourable craft, and I believe that this is the first complete and practical work published on the subject.

In preparing this work my aim and purpose has been to fill this long existing void by furnishing for the use of my brethren of the craft a practical treatise on the manufacture, use, and manipulation of all materials, and a description of the numerous processes employed by plasterers and modellers.

Although fortified by a life-long study of the subject, together with a most varied experience, I make no claim to literary ability, and would disarm my critics by reminding them of Pope's incontrovertible poetical axiom :

"Whoever thinks a faultless work to see,
Thinks what ne'er was, nor is, or e'er can be."

That this book may help to spread a knowledge of the means and methods of executing all kinds of work in plaster, and so cause a greater appreciation of it, and a desire for its wider use, thus bringing about a true revival of the craft, to the benefit both of the employer and craftsman, is my earnest wish. Should this anticipation be realised, my reward will be in the consciousness that I have been the means of forwarding the study of my favourite art and craft.

To the above lines (written for the most part more than four years ago), I desire to add, in justice to my publisher, that since he announced the publication of the book in 1865, I have thoroughly revised it, re-casting some parts, enlarging others, and introducing descriptions of new materials and processes. This has occupied more time than at first seemed probable, and has caused the not inconsiderable delay that has occurred in its production, but which, it is hoped, may be more than atoned for by the greater completeness of the work. In conclusion, I have much pleasure in acknowledging the assistance afforded me by Mr Bradley Batsford, especially in helping me to add numerous valuable illustrations to those I had already drawn and collected.

WILLIAM MILLAR.

LONDON, *March* 1867.

NOTE TO THE SECOND EDITION.

I HAVE every reason to be gratified with the success achieved by my book, as shown by the sale of a large edition in less than two years, and the continued demand, to meet which a Second Edition has become necessary.

I have carefully read the book through, and have made such small corrections and alterations as appeared necessary. That it has defects I make no doubt, but it is satisfactory to know that although it has been in use in large numbers during nearly two years, none worthy of mention have been discovered in it either by its users, or its critics. On the other hand, I have received a large number of letters expressing the greatest satisfaction with it from fellow craftsmen, members of the architectural profession, and others.

Finally, I may mention that the Worshipful Company of Plaisterers were good enough to send me not only a highly eulogistic letter, but also a handsome testimonial of their appreciation of my work.

W. M.

March 1867.

CONTENTS.



CHAP.	PAGE
LIST OF PLATES - - - - -	xi
LIST OF ILLUSTRATIONS IN THE TEXT - - - - -	xiii
INTRODUCTORY—"A GLIMPSE OF ITS HISTORY" (By G. T. ROBINSON, F.S.A.) - - - - -	1
I. HISTORICAL PLASTERING IN ENGLAND, SCOTLAND, AND IRELAND	24
II. MATERIALS - - - - -	35
III. MATERIALS—CONTINUED - - - - -	55
IV. LIME PLASTERING - - - - -	89
V. DECORATIVE CEILINGS - - - - -	123
VI. RUNNING DIMINISHED AND CIRCULAR MOULDINGS - - - - -	148
VII. EXTERIOR PLASTERING - - - - -	181
VIII. MODELLING - - - - -	224
IX. MOULDING AND CASTING - - - - -	249
X. MODEL AND RUNNING MOULD MAKING - - - - -	290
XI. GELATINE MOULDING - - - - -	317
XII. FIBROUS PLASTER WORK - - - - -	343
XIII. REVERSE MOULDING - - - - -	380
XIV. COMPOSITIONS - - - - -	393
XV. SCAGLIOLA - - - - -	407
XVI. FOREIGN PLASTER WORK - - - - -	420
XVII. TERRA COTTA - - - - -	450
XVIII. CONCRETE - - - - -	456
XIX. CONCRETE—CONTINUED - - - - -	485
XX. RUDIMENTARY GEOMETRY AND ARCHITECTURE - - - - -	517
XXI. TOOLS AND APPLIANCES - - - - -	537
APPENDIX - - - - -	555
INDEX - - - - -	580



LIST OF PLATES.

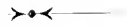

PLATE	FRONTISPIECE.	
	I. PLASTER PAVEMENT AT TEL-EL-AMARNA, EGYPT, 1400 B.C.	<i>following page</i> 34
	II. STUCCO CEILING IN A TOMB, VIA LATINA, ROME, FIRST CENTURY	" " 34
	III. STUCCO CEILING AND WALL DECORATION, PALAZZO D'ALBRIZZA, VENICE, BY A. VITTORIO, 1560 - - - - -	" " 34
	IV. STUCCO CEILING, OVER-DOOR, AND WALL DECORATION, PALAZZO D'ALBRIZZA, BY A. VITTORIO, 1560 - - - - -	" " 34
	V. STUCCO PILLARS, COURTYARD OF THE PALAZZO VECCHIO, FLORENCE, 1566 - - - - -	" " 34
	VI. EXTERNAL PLASTER WORK, ANCIENT HOUSE IN CLARE, SUFFOLK, 1473 - - - - -	" " 34
	VII. PLASTER CEILING, LOSELY HOUSE, NEAR GUILDFORD, 1562 - - - - -	" " 34
	VIII. PLASTER CEILING, COOPER'S HOUSE, GREAT YARMOUTH, 1596 - - - - -	" " 34
	IX. PLASTER CEILING, PEARTREES HOUSE, GREAT YARMOUTH, SIXTEENTH CENTURY - - - - -	" " 34
	X. PLASTER CEILING, 4 SOUTH QUAY, GREAT YARMOUTH, SIXTEENTH CENTURY - - - - -	" " 34
	XI. PLASTER CEILING, BRAMSHILL, HAMPSHIRE, 1603 - - - - -	" " 34
	XII. PLASTER CEILING, AUDLEY END, 1610 - - - - -	" " 34
	XIII. PLASTER CEILING, STATE BEDCHAMBER, BOSTON HOUSE, 1623 - - - - -	" " 34
	XIV. PLASTER CEILING, CRAIGIEVAR, ABERDEENSHIRE, 1611 - - - - -	" " 34
	XV. PLASTER CEILING, MORAY HOUSE, EDINBURGH, 1618 - - - - -	" " 34
	XVI. PLASTER CEILING, WINTON HOUSE, MIDLOTHIAN, 1620 - - - - -	" " 34
	XVII. STUCCO CEILING, HOLYROOD PALACE, EDINBURGH, 1671 - - - - -	" " 34
	XVIII. EXTERNAL PLASTER WORK, SPARROW HOUSE, IPSWICH, 1683 - - - - -	" " 34
	XIX. PLASTER CEILING, CHURCH OF ST MARTIN'S-IN-THE-FIELDS, LONDON, 1722 - - - - -	" " 34
	XX. PLASTER CEILING, QUEEN'S BEDCHAMBER, PALACE OF VERSAILLES, LOUIS XV. - - - - -	" " 34
	XXI. PLASTER CEILING, SALON DES MEDAILLES, PALACE OF VERSAILLES, LOUIS XV. - - - - -	" " 34
	XXII. PLASTER CEILING, STUDY OF THE QUEEN OF ITALY'S VILLA, TURIN, EIGHTEENTH CENTURY - - - - -	" " 34
	XXIII. PLASTER CEILING, MILTON HOUSE, CANONGATE, EDINBURGH, 1725 - - - - -	" " 34
	XXIV. PLASTER CEILING AND CORNICE, DINING-ROOM, COLESHILL, BERKSHIRE, BY INIGO JONES, 1750 - - - - -	" " 34

List of Plates.

PLATE		
XXV.	PLASTER CEILING, QUEEN'S ROOM, OLD BUCKINGHAM HOUSE, LONDON, BY R. ADAM, 1760 - - - - -	<i>following page</i> 34
XXVI.	PLASTER CEILING, KEDLESTON, DERBYSHIRE, BY G. RICHARDSON, 1770 - - - - - 34
XXVII.	PLASTER CEILING, LORD MONTALT'S MANSION, DUBLIN, BY G. RICHARDSON, 1770 - - - - - 34
XXVIII.	WALL DECORATION, BY PERGOLESI, 1768 - - - - - 34
XXIX.	ELEVATION OF CORINTHIAN ENTABLATURE AND PLAN OF CORNICE AT EXTERNAL ANGLE - - - - -	<i>facing page</i> 112
XXX.	PERSPECTIVE VIEW OF PLASTER CEILING IN KING CHARLES' ROOM, WINTON HOUSE, MIDLOTHIAN, 1620, WITH WORKING PLAN - - - - - 134
XXXI.	PLASTER CEILING, PRINCES STREET, EDINBURGH, 1850 - - - - - 136
XXXII.	PLASTER CEILING, THRONE ROOM, HOLYROOD PALACE, EDIN- BURGH, 1854 - - - - - 138
XXXIII.	PLASTER CEILING AT BRADFORD IN THE ADAM STYLE, 1879 - - - - - 138
XXXIV.	PLASTER CEILING AND WALL DECORATION, HILL PARK HOUSE, FORIAR, SCOTLAND, 1870 - - - - - 140
XXXV.	DECORATIVE PLASTER WORK IN STAIRCASE OVER ENTRANCE HALL, PARK CIRCUS, GLASGOW, 1880 - - - - - 140
XXXVI.	PLAN OF DRAWING-ROOM CEILING AT TODDINGTON, GLOUCESTER- SHIRE, 1819 - - - - - 140
XXXVII.	PERSPECTIVE VIEW OF DRAWING-ROOM AT TODDINGTON, GLOU- CESTERSHIRE, 1819 - - - - - 140
XXXVIII.	GROINED CEILING, TRINITY COLLEGE, PERTSHIRE, 1845 - - - - - 142
XXXIX.	SETTING OUT AND PLASTERING CUPOLA PANELS AND MOULD- INGS, AND SOFFITS OF ARCHES - - - - - 164
XL.	CIRCULAR MOULDINGS ON CIRCULAR SURFACES - - - - - 172
XLI.	CIRCULAR MOULDINGS ON CIRCULAR SURFACES - - - - - 174
XLII.	ITALIAN RENAISSANCE PANELS FROM VENICE - - - - - 236
XLIII.	MOULDING BUSTS IN GELATINE - - - - - 326
XLIV.	CEILING IN THE SALOON AT COOMBE PARK, SEYENOAKS, DE- SIGNED AND MODELLED BY WALTER CRANE - - - - - 402
XLV.	PLASTER WORK OF MIHRAB IN ABUL HACEN'S MOSQUE, ALGIERS, 1296 - - - - - 424
XLVI.	PLASTER CEILING, PERSIA, EIGHTEENTH CENTURY - - - - - 426
XLVII.	MOORISH PLASTER WORK, ENTRANCE TO THE COURT OF THE LIONS IN THE ALHAMBRA, SPAIN, THIRTEENTH CENTURY - - - - - 428
XLVIII.	DIAPERED PLASTER PANNELLING IN THE ALHAMBRA, SPAIN, THIRTIETH CENTURY - - - - - 430
XLIX.	PLASTER DECORATION IN A SYNAGOGUE, NOW CHURCH CALLED DEL TRANSITO, IN TOLEDO, 1366 - - - - - 432
L.	PLASTER CEILING IN A TOMB AT DELHI, 1528 - - - - - 434
LI.	PLASTER CENTRE FLOWER FROM BERLIN, BY R. SCHIRMER - - - - - 444
LII.	PLASTERERS' TOOLS, PLANT, AND APPLIANCES - - - - - 538

LIST OF ILLUSTRATIONS IN THE TEXT.

- >•< ---

NO.		PAGE	NO.		PAGE
1.	Stucco decorations on a vaulted ceiling, Rome - - -	5	31.	Floating fluted columns, rim method - - -	156
2.	Stucco decorations, Great Baths, Pompeii - - -	6	32.	Forming fluted columns, collar method - - -	157
3.	Stucco ceiling, Ducal Palace, by A. Vittorio - - -	10	33.	Section of cove, showing pressed screed process - - -	158
4.	Stucco ceiling, Scala di Giove, Florence - - -	11	34.	Floated coves, levelling rule - - -	159
5.	Stucco decoration, Palace of Fontainebleau - - -	13	35.	Section, double diminished mouldings, false screed method - - -	160
6.	External plaster work, Wyvenhoe - - -	17	36.	Elevation of double diminished mouldings - - -	160
7.	Plaster ceiling, London, 1620 - - -	18	37.	Elevations and section of running mould for double diminished mouldings, diminished rule method - - -	162
8.	Plaster ceiling, Lime Street, London, 1620 - - -	19	38.	Elevations, plan, and sections of ditto, top rule method - - -	163
9.	Plaster ceiling, London, 1628 - - -	20	39.	Trammels - - -	167
10.	Plaster ceiling, Carnock Castle - - -	21	40.	Template and pin-mould for running elliptical arch mouldings - - -	169
11.	Elevation and profile of cornice, Milton House - - -	22	41.	Setting out and constructing plasterer's oval - - -	170
12.	Cement testing machine - - -	59	42.	Plans and elevations of coved ceilings - - -	172
13.	Wall plumbing - - -	93	43.	Forming niches with running moulds - - -	179
14.	Skirting formation - - -	101	44.	Plumbing running moulds - - -	186
15.	Modillion - - -	113	45.	Pitch of pediments - - -	192
16.	Corinthian cornice - - -	114	46.	Raking mouldings - - -	193
17.	Mitre mould - - -	116	47.	Side and front elevation of Ionic modillion, with raking modillion - - -	194
18.	Frieze, Palace Chambers, London - - -	118	48.	Setting out and forming a Doric portico - - -	195
19.	Fret ornaments - - -	119	49.	Setting out triglyphs - - -	196
20.	Plaster ceiling, Careath House - - -	135	50.	Setting out and forming Ionic niche - - -	197
21.	Plaster ceiling, Beeslack - - -	136	51.	Plain pedestal - - -	198
22.	Fibrous plaster ceiling, Liverpool - - -	138	52.	Setting out and forming compound open pediment - - -	199
23.	Plaster ceiling, Dublin - - -	139	53.	Front and side elevation of modillion for exterior work - - -	199
24.	Jack template, and spike and rope bracket - - -	144	54.	Setting out and forming block cornice and quoins - - -	200
25.	Plan of intersection board - - -	145	55.	Setting out quoins - - -	201
26.	Elevation of ribs, plan of wall intersection board, and pin-mould - - -	146	56.	Plan and elevation of gateway, with rustications - - -	202
27.	Half-rib pin-mould - - -	146			
28.	Panels for panelled ceilings, classic style - - -	147			
29.	Diminishing columns, trammel and floating rule - - -	149			
30.	Diminished fluted columns - - -	152			

NO.	PAGE	NO.	PAGE
57. Columns and arches, the Corinthian order over the Ionic on a rustic basement - - -	203	96. Reducing or enlarging irregular figures - - -	289
58. Balustrade construction - - -	205	97. Setting out a truss and a cornice - - -	291
59. Plain and enriched balusters, round, square, and octagonal on plan - - -	206	98. Making the model of a truss - - -	292
60. Examples of pierced work for balustrades - - -	207	99. Keystone - - -	294
61. Forming windows - - -	208	100. Hinged moulds - - -	295
62. Forming window heads - - -	209	101. Corinthian capital from Palladio - - -	296
63. Forming dormer window - - -	210	102. Setting out Corinthian column and pilaster capitals - - -	297
64. Setting out an Elizabethan gable - - -	211	103. Section of mould for Corinthian column capital - - -	298
65. Sgraffito frieze from Florence - - -	212	104. Natural acanthus leaf - - -	298
66. Sgraffito frieze from Rome - - -	213	105. Composite capital - - -	299
67. Sgraffito panels, by G. E. Robinson, F.S.A. - - -	214	106. Plan and elevation of the Composite capital - - -	299
68. Sgraffito panels, do. do. - - -	214	107. Plans, elevations, and sections of Ionic capitals and entablature - - -	300
69. Sgraffito retable, do. do. - - -	215	108. Setting out the Ionic volute - - -	300
70. Sgraffito friezes in two colours - - -	217	109. Centre flower, Palace Club, London - - -	303
71. Sgraffito frieze in two colours - - -	218	110. Half-section of centre flower, Palace Club, London - - -	304
72. Sgraffito frieze in three colours and shading tints - - -	219	111. Plan of run body and rim moulding of centre flower, Palace Club, London - - -	305
73. Sgraffito border in two colours - - -	220	112. Permanent joint of the body of centre flower - - -	306
74. Sgraffito border in two colours - - -	221	113. Centre and drop, with ornament, roughed out in the clay - - -	306
75. Plaster ceiling, centre panel fresco, modern - - -	222	114. Prize centre flower, plan and section - - -	307
76. Anatomical figure - - -	225	115. Soffit enrichment - - -	308
77. Venus of Milo - - -	226	116. Internal mitre of soffit enrichment - - -	308
78. Exterior ornamentation in Portland cement, modelled <i>in situ</i> - - -	231	117. Cast enrichment mitres - - -	309
79. Frieze, modelled <i>in situ</i> - - -	232	118. To make a running mould - - -	310
80. Modelling stool - - -	233	119. Section of cornice - - -	312
81. Bust support - - -	233	120. Elevation of prize cornice - - -	312
82. Wood modelling tools - - -	234	121. Twin-slipped mould - - -	313
83. Wire modelling tools - - -	235	122. Radius mould - - -	313
84. Adjustable calipers - - -	235	123. Arch radius mould - - -	314
85. Pilaster panel from Venice - - -	237	124. Hanging running moulds - - -	314
86. Truss - - -	238	125. Running mould for splayed angles - - -	315
87. Ornamental pilaster - - -	238	126. Moulding a truss with gelatine - - -	326
88. Patent plaster-box - - -	250	127. Compound moulding piece for gelatine - - -	328
89. Making a front wax mould and an open front wax mould - - -	254	128. Section and elevation of a fibrous plaster balcony front - - -	333
90. Making jointed and surface wax moulds - - -	257	129. Running concavo-convex mouldings, do. - - -	335
91. Making a front and back wax mould - - -	259	130. Section of moulding piece, do. - - -	336
92. Making a moulding piece from a front and back mould - - -	260	131. Section of jelly mould, do. - - -	338
93. Plaster piece moulding a modillion - - -	269	132. Section of cast, do. - - -	338
94. Plaster piece moulding a baluster - - -	272		
95. Plaster piece moulding a vase - - -	275		

List of Illustrations in the Text.

xv

NO.	PAGE	NO.	PAGE
133. Fibrous plaster panel for proscenium	341	166. Persian centre-piece	427
134. Section of moulding piece, do.	342	167. Persian plaster panel	427
135. Panel mould for a fibrous plaster cast	348	168. Persian plaster frieze	428
136. Casting a fibrous plaster centre flower	351	169. Persian plaster chimney-piece and wall decoration	429
137. Casting fibrous plaster plain cornices	354	170. Persian plaster frieze	430
138. Casting fibrous plaster enriched cornices, by the bedded enrichment system	357	171. Setting out plaster prisms for pendentive ceilings (Moorish)	430
139. Casting fibrous plaster enriched cornices, by the cast system	362	172. Indian centre-piece	434
140. Bench slab mould	369	173. Indian centre-piece	434
141. Finished face slab mould	375	174. Coved ceilings of circular rooms	437
142. Fibrous plaster panel with diagonal laths	377	175. Enriched soffits of arches from Rome	438
143. Setting out a reverse running mould for a cornice	381	176. Stucco frieze from the Ducal Palace, Venice	439
144. Reverse running mould for a cornice casting mould	382	177. Cartouche from the Bibliotheque Nationale, Paris	439
145. Reverse casting mould	384	178. Cartouche, Lyons	440
146. Reverse moulds for panel mouldings	384	179. Plaster ceiling (German)	442
147. Reverse moulds for rib mouldings	385	180. Plaster cornices (German)	443
148. Reverse moulds for plain caps	385	181. Plaster wall panel (German)	444
149. Reverse casting moulds for diminished fluted columns and pilasters	386	182. Plaster ceiling, Vienna	445
150. Reverse running mould for reverse casting mould for plain columns	388	183. Plaster angle piece, Vienna	446
151. Reverse casting mould for plain columns	389	184. Portion of an external column, Vienna	447
152. Reverse moulds for over-doors	390	185. Pilaster panel, Brussels	448
153. Panel for over-door	391	186. Pilaster panel, Brussels	448
154. Candelabra in carton-pierre	395	187. Keystones and antefix	452
155. Plaster ceiling, with figure panels in gesso	403	188. Sections of concrete kerb, channel, and paving	473
156. Ornamental plaster work on the arcades in the Mosque of Ibn-Tulun, ninth century	421	189. Examples of grooved surfaces	475
157. Plaster frieze in Mosque of Sultan Hasan, fourteenth century	422	190. Half plan of coach yard	477
158. Plaster frieze in the Mosque of En-Nasireeyeh	422	191. Plan of stable floor	478
159. Ceiling, Kalanoun Mosque, in Cairo, fourteenth century	423	192. Sections of the various parts of stable floor	478
160. Cornice, Kalanoun Mosque, in Cairo	423	193. Sections of nosing moulds with riser boards	488
161. Arabesque from the Great Mosque, Damascus	424	194. Jointed nosing mould with riser board	488
162. Arabian panel	425	195. Framing for concrete stairs constructed <i>in situ</i>	489
163. Plaster and glass window from Cairo	425	196. Sections of framing of soffit of stairs	492
164. Plaster frieze from Turkey	425	197. Sections of steps	496
165. Persian ceiling from Teheran	426	198. Treads and risers	496
		199. Closed outer strings	496
		200. Wedge casting mould	505
		201. Moulds for casting blocks and string mouldings	506
		202. Moulds for casting sills and copings	506
		203. Moulds for casting concrete mouldings <i>in situ</i>	508
		204. Setting out ovals, arches, octagons, and templates	518

List of Illustrations in the Text.

NO.		PAGE.	NO.		PAGE
205.	Setting out arches - - -	519	220.	Columns and entablatures in the Corinthian and Composite orders	532
206.	Setting out Gothic arches, panels, and angles - - -	520	221.	Doric impost and archivolt mouldings	533
207.	Setting out angle brackets for coves	522	222.	Ionic impost and archivolt mouldings	533
208.	Setting out angle brackets for cor- nices - - -	522	223.	Tuscan impost and archivolt mould- ings - - -	533
209.	Mouldings, plain and enriched -	523	224.	Corinthian impost and archivolt mouldings - - -	533
210.	Setting out Roman mouldings -	525	225.	Composite impost and archivolt mouldings - - -	533
211.	Setting out Grecian mouldings -	526	226.	Balusters of the five orders and ramped balustrade - - -	534
212.	Setting out a bead and scotia -	526	227.	Setting out balusters and pedestals for balustrades - - -	535
213.	Columns and entablatures - - -	527	228.	Mitring and stopping tools - - -	543
214.	Columns and entablatures - - -	527	229.	Scratch tools - - -	544
215.	Acanthus mollis, The - - -	528	230.	Plaster small tools - - -	545
216.	Grecian capital - - -	529	231.	Plasterers' plant and labourers' tools	547
217.	Tuscan column and entablature -	530			
218.	Setting out an Ionic pedestal for a column - - -	530			
219.	Corinthian capital - - -	531			

PLASTERING—PLAIN AND DECORATIVE.

INTRODUCTORY CHAPTER.

A GLIMPSE OF ITS HISTORY.

BY G. T. ROBINSON, F.S.A.

PLASTERING—PREHISTORIC—IN THE DAWN OF HISTORY—IN EARLY EGYPT—AMONGST THE GREEKS AND THEIR COLONIES—ROMAN WORK FROM THE COMMENCEMENT TO THE DECLINE AND FALL OF THE EMPIRE—ITS ORIENTAL DEVELOPMENT—IN THE MIDDLE AGES—IN THE RENAISSANCE—ITS CULMINATION IN THE SIXTEENTH CENTURY—ITS DECORATIVE GROWTH IN FRANCE AND ENGLAND—UNDER FRANCIS I. AND HENRY VIII.—UNDER THE STUART DYNASTY—ITS DECLINE UNDER THE HANOVERIAN INFLUENCE—ITS LOW CONDITION AT THE END OF LAST CENTURY—ITS HOPED FOR REVIVAL.

PLASTERING is one of the earliest instances of man's power of inductive reasoning, for when men built they plastered: at first, like the birds and the beavers, with mud, but they soon found out a more lasting and more comfortable method, and the earliest efforts of civilisation were directed to plastering. The inquiry into it takes us back to the dawn of social life, until its origin becomes mythic and prehistoric. Into that dim, obscure period we cannot penetrate far enough to see clearly, but the most distant glimpses we can obtain into it show us that man had very early attained almost to perfection in compounding material for plastering. In fact, so far as we yet know, some of the earliest plastering which has remained to us excels, in its scientific composition, that which we use at the present day, telling of ages of experimental attempts. The pyramids of Egypt contain plaster work executed at least four thousand years ago (some antiquaries, indeed, say a much longer period), and this, where wilful violence has not disturbed it, still exists in perfection! outvying in durability the very rock it covers, where this is not protected by its shield of plaster. Dr Flinders Petrie, in his "Pyramids and Temples of Gizeh," shows us how serviceable and intelligent a co-operator with the painter, the sculptor, and the architect, was the plasterer of those early days, and that to his care and skill we owe almost all we know of the history of these distant times and their art. Indeed the plasterer's very tools do yet remain to us, showing that the technical processes then were the same we now use, for there are in Dr Petrie's collection at University College, London, hand floats which in design, shape, and purpose, are precisely those which we use to-day. Even our newest invention of canvas plaster was well known then, and by it were made the masks which yet preserve on the mummy cases the lineaments of their occupants.

The plaster used by the Egyptians for their finest work was derived from burnt gypsum, and was therefore exactly the same as our "plaster of Paris." Its base was of lime stucco, which, when used on partitions, was laid on reeds, laced together with cords, for lathing, and Mr Millar, who has examined a fragment in Dr Petrie's collection, finds it practically "three coat work," about $\frac{3}{4}$ of an inch thick, haired, and finished just as we do now.

Plaster moulds and cast slabs exist, but there does not appear any evidence of piece moulding, nor does any evidence of the use of modelled work in plaster exist. That some process of indurat-

ing, plaster was thus early known is evidenced by the plaster pavement at Tel-el-Amarna, which is elaborately painted. The illustration of it given on Plate I,* is taken from a drawing by Dr Petrie, and kindly lent by the editor of *The Builder*. This floor is laid on brick; the first coat is of rough lime stucco about 1 inch thick, and the finishing coat of well-haired plaster about $\frac{1}{2}$ inch thick, very smooth and fine, and showing evidence of trowelling, the setting out lines for the painting being formed by a struck cord before the surface was set, and the painting done on fresco. It is about 60 by 20, and formed the floor of the principal room of the harem of King Amenhotep IV., about fourteen hundred years before Christ, that is, between three thousand and four thousand years ago. Long before this, plastering of fine quality existed in Egypt, and so long as its civilisation continued it aided the comfort of the dwellings of its people and the beauty of its temples.

Nor was it merely for its beauty and comfort that plaster work was used. Even then its sanitary value was recognised, and the directions given in Leviticus xiv. 42-48, which was probably written about one hundred years before this date, show that the knowledge of its antiseptic qualities was widely spread, and the practice of it regarded as religious duty.

Unfortunately there is no direct evidence that the adjacent Assyrian powers of Nineveh and Babylon used plaster work. Possibly the fine clay brought down by the rivers of the Euphrates and the Tigris sufficed for all their purposes. Their records are in it; their illustrations on the sculptured walls of their palaces are in stone, their painting is glazed on their bricks, and for them there seems to have been but little need for plaster work, nor do we find until the rise of Grecian art anything relating to our subject.

Very early in Greek architecture we find the use of plaster, and in this case a true lime stucco of most exquisite composition, thin, fine, and white. Some has been found at Mycenæ, a city of Homeric date. We know that it existed in perfection in Greece about five hundred years before the Christian era. With this the temples were covered externally, and internally where they were not built of marble, and in some cases where they were. This fine stucco was often used as a ground on which to paint their decorative ornament, but not unfrequently left quite plain in its larger masses, and some of it remains in very fair preservation even to this day. The Temple of Apollo at Bassæ, built of yellow sandstone about 470 B.C., has on its columns the remains of a fine white stucco.

Pavements of thick hard plaster, stained, of various colours, were common in the Greek temples. One of these, that of the Temple of Jupiter Panhellenius at Ægina, built about 570 B.C., is described by Cockerell as existing in the early part of this century, in good condition, though the temple itself was destroyed; and I have seen at Agrigentum, plaster existing in perfect state, though scarcely thicker than an egg-shell, on the sheltered parts of a temple built at least three hundred years before our era, whilst the unprotected stone was weather-worn and decayed.

What care the ancient Greeks bestowed on their stucco may be inferred from Pliny's statement that in the temple at Elis about 450 B.C., Pammenus, the nephew of Phidias, used for the groundwork of his picture "stucco mixed with milk and saffron, and polished with spittle rubbed on by the ball of the thumb, and," says he, "it still retains the odour of saffron." Lysippus, the first of the Greek "realists" in sculpture, was the first we hear of who took casts of the faces of living sitters about 350 B.C., so the art of plaster casting must have advanced a good deal by that time, as he made presents of copies to his friends. Afterwards we read of many sculptors who sent small plaster models of their works to friends. These were, however, probably carved in the plaster rather than cast.

Whether the Greeks used stucco for modelling is a somewhat doubtful point amongst antiquarians. From certain passages in classic writers I am induced to think they did. Pausanius,

* Plates I. to XXVIII., illustrating this and the following chapter, will be found after page 34.

who describes the temple at Stymphalus, an almost deserted and ruined city when he visited it about 130 A.D., describes the ceiling of the Temple of the Stymphalides, built about 400 B.C., as being "either of stucco or carved wood," he could not decide which, but his very doubt would imply that stucco or wood were equally common. Now this ceiling was ornamented with panels and figures of the harpies—omens of evil, half woman and half bird, with outspread wings. He also mentions a statue of Bacchus in "coloured stucco." Of course these are not definite proofs of early Greek stucco modelling, but as the city of Stymphalus had decayed and become depopulated before 200 B.C., there is certainly presumptive evidence of the ancient practice of the art. Again, figures of unburnt earth are mentioned in contradistinction to those of terra cotta, and sundry other allusions to plastic work occur, which lead me to the opinion that quite early in Greek Art this mode of using plaster began. At any rate, we know that it was early introduced into *Grecia Magna*—the earliest Southern Italian colony of the Greeks; and as colonists invariably preserve the customs and traditions of their fatherland even long after they have fallen into disuse in their native home, we can have no reasonable doubt but this art was imported rather than invented by them. Thence it spread to the Etruscans of Middle Italy, a cognate people to the Southern Greeks, by whom both plain and modelled stucco was largely used. The Etruscans, as we have seen, were more closely allied to the Greek than the Latin race, but in the course of time these two races amalgamated, the former bringing skill in handicraft, the latter lust of power, and patriotic love of country and of glory, whilst the Grecian element, which blended harmoniously with the first of these, added a love of Art.

This union, however, took long to ripen to artistic fruitfulness. The practical Etruscan element firstly constructed the roads and the sewers, and gave health to Rome. The Latins added to their territory until it embraced half of Europe, giving wealth to Rome, and not till the luxury and comfort thus created did the artistic element of the Greek come in, giving beauty to Rome, and the day of decorative plaster work approached its noontide glory, making Rome the attraction of the world. The absorbence of Greece as a Roman province took place B.C. 145, and the loot of it began, giving an enormous impetus to Roman Art. Thousands of statues were brought to Rome, and to be deemed a connoisseur in things artistic or a patron of the arts became the fashionable ambition. But it was not until the century just preceding the Christian era that it became especially noteworthy. Of course there is hardly anything left to us of the very early plaster work of Rome. The constant search for some new thing was inimical to the old. Old structures were pulled down to make way for new, which in their turn gave way to newer, and until the age of Augustus we have but little of the early work left. Strabo, who visited Rome about this time, complains of the destruction caused by "the numerous fires, and continued pulling down of houses rendered necessary, for even pulling down and rebuilding in order to gratify the taste is but voluntary ruin"; and Augustus, who boasted that "he found Rome of brick and left it of marble," in replacing the brick with marble destroyed the plaster work. How that plaster work was wrought we shall learn more from Vitruvius, who wrote his book on architecture about 16 B.C., and dedicated it to the emperor, "in order to explain the rules and limits of Art as a standard by which to test the merits of the buildings he had erected or might erect."

Now, Vitruvius was a man who had travelled and seen much. He was with Julius Cæsar as a military engineer in his African campaign in 46 B.C., or ten years after Cæsar's invasion of Britain. Afterwards he became a designer of military engines, what we should call head of the Ordnance Department, and also a civil engineer, persuading himself that he had a pretty taste in architecture, just as though he were an R.E. of to-day. Thus he had a practical and also an artistic training, and here is what he says on matters connected with plaster work in Book VII.,

Chapter II. On tempering lime for stucco: "This requires that the lime should be of the best quality, and tempered a long time before it is wanted for use; so that if any of it be not burnt enough, the length of time employed in slaking it may bring the whole mass to the same consistency." He then advises it to be chopped with iron hatchets, adding that "if the iron exhibits a glutinous substance adhering to it, it indicates the richness of the lime, and the thorough slaking of it." For cradling out, and for ceiling joists, he recommends "the wood to be of cypress, olive, heart of oak, box, and juniper," as neither liable to "rot or shrink." For lathing he specifies, "Greek reeds bruised and tied with cords made from Spanish broom," or if these are not procurable, "marsh reeds tied with cords." On these a coat of lime and sand is laid, and an additional coat of sand is laid on to it. As it sets it is then polished with chalk or marble. This for ceilings. For plaster on walls he says: "The first coat on the walls is to be laid on as roughly as possible, and while drying, the sand coat spread thereon. When this work has dried, a second and a third coat is laid on. The sounder the sand coat is, the more durable the work will be. The coat of marble dust then follows, and this is to be so prepared that when used it does not stick to the trowel. Whilst the stucco is drying, another thin coat is to be laid on; this is to be well worked and rubbed, and then still another, finer than the last. Thus with three sand coats and the same number of marble dust coats the walls will be solid, and not liable to crack." "The wall that is well covered with plaster and stucco, when well polished, not only shines, but reflects to the spectators the images falling on it. The plasterers of the Greeks not only make their stucco work hard by adhering to these directions, but when the plaster is mixed, cause it to be beaten with wooden staves by a great number of men, and use it after this preparation. Hence some persons cutting slabs of plaster from ancient walls use them for tables and mirrors" (Chapter III.).

You will see by these remarks the great care taken through every process, and how guarded the watchfulness over the selection of materials, and you will also note the retrospectiveness of Vitruvius' observation, how he felt that the work done before the frantic haste of his own time was the better: very much as we find now. Time is an ingredient in all good work, and its substitute difficult to find.

There are other "tips" contained in Chapter III. which are worth extraction, as, for instance, his instructions as how to plaster damp walls. In such case he primarily suggests a cavity wall, with ventilation to ensure a thorough draught, and then plastering it with "potsherd mortar," or carefully covering the rough plaster with pitch, which is then to be "lime whited over," to ensure "the second coat of pounded potsherds adhering to it," when it may be finished as already described. Further, he refers to modelled plaster work, which, he says, "ought to be used with a regard to propriety," and gives certain hints for its appropriate use. Speaking of pavements "used in the Grecian winter rooms, which are not only economical but useful," he advises "the earth to be excavated about 2 feet, and a foundation of potsherds well rammed in," and then a "composition of pounded coals, lime, sand, and ashes is mixed up and spread thereover, $\frac{1}{2}$ foot in thickness, perfectly smooth and level. The surface then being rubbed with stone, it has the appearance of a black surface," "and the people, though barefoot, do not suffer from cold on this sort of pavement." Now all this bespeaks not only theoretical knowledge, but practical observation and experience, and was written nearly two thousand years ago, from which you can surmise how far advanced practical plastering had then become. This written evidence is almost all we have of the work of Vitruvius' own time, for even of the time of Augustus hardly anything remains to us, as the great fire of Nero utterly destroyed the greater part of the city in the year A.D. 64, and almost the only authenticated piece of plaster work done before or during his reign is the *Tabula Iliaca*, a

bas-relief of the siege of Troy, still preserved in the Capitol Museum at Rome. That this was modelled by Greek artists is proved by the fact that its inscriptions are all in Greek language, and by some it is considered to be of very much greater antiquity.

Illustration No. 1 shows a good example of the character of modelled stucco which prevailed about this period. This is a small portion of a large surface of plaster which was on a vault cut through in making the excavations for the canalization of the Tiber at Rome. There were many compartments of various sizes, and the modelling is of an exquisite delicacy. Casts of these you can see in South Kensington Museum, and some of the smaller cartouches are almost as fine as cameos. In the same valuable museum you will find a series of arched tiles of very bright red, on which small subjects have been modelled in stucco, forming a very pleasing and suggestive combination. These are from an Italo-Greek tomb, and of the early part of first century. Of about the same date is the example given on Plate II., from the vaulted ceiling of a tomb in the Via Latina

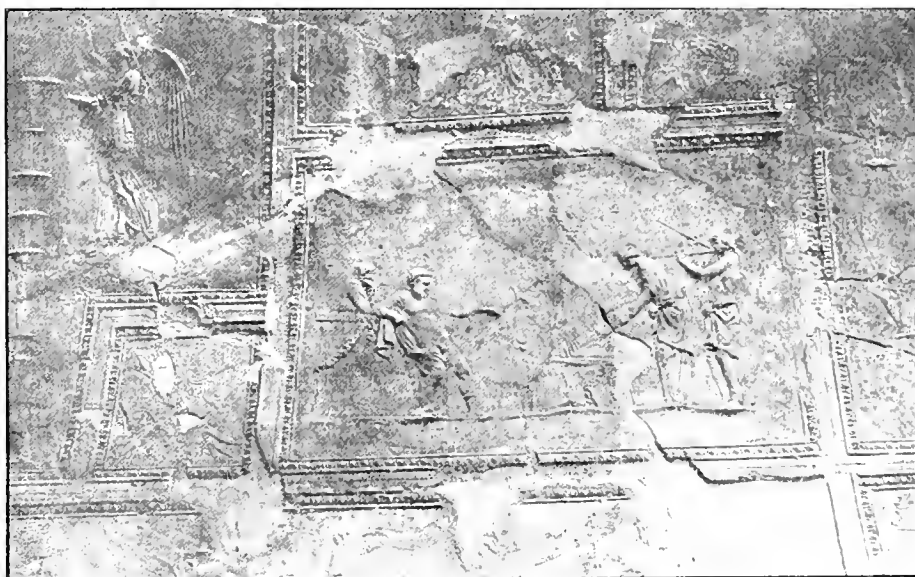

NO. 1.—STUCCO DECORATIONS ON A VAULTED CEILING, ROME, FIRST CENTURY.

at Rome, the walls of which are covered with some very delicately modelled arabesque ornament. Both these are evidently the work of Greek artists. The more Roman method is shown in Illustration No. 2, from the Great Baths of Pompeii, which must have been executed before the year 79 A.D., when the city was buried by the ashes thrown up in an eruption of Vesuvius, and with it perished the natural philosopher and historian, Pliny the younger, who tells us that "no builder should employ lime which had not been slacked at least three years," "and that the Greeks used to grind their lime very fine," and that they beat it with pestles of wood. The very eruption which destroyed Pompeii preserved it to us, for the light scoria which fell upon it covered up the most delicate work, and it is now a museum of decorative plaster work and decorative art generally, for there stucco treatments abound. Not only did it decorate, but it preserved the fragile and inflammable structures by its fireproof coating. The ordinary plaster was evidently prepared according to the prescription of Vitruvius, the sand coating, or arenatum, he describes being here formed of decomposed lava or volcanic sand, the final coat laid on being very thin, less than $\frac{1}{16}$ inch in the

Plastering—Plain and Decorative.

best work. When colour was used it was chiefly fresco, done whilst the plaster was moist. Sometimes the colour was even mixed with the plaster, and every variety of plastering skill was called into service, scagliola, gesso, sgraffito, impressed and relieved work, for Pompeii was evidently a city of plaster work, but I am afraid the "jerry" builder was born before much of Pompeii was built, and then, as now, he relied upon the plasterer to cover up his iniquities.

There was more solid construction at Herculaneum, which was destroyed by the same volcanic eruption, but there, unfortunately, lava, hot and semi-fluid, was the overwhelming substance, and thus the more delicate fabrics perished. Of course much of the work thus destroyed was of earlier date than that of the catastrophe, though unfortunately we have no record of its technical history; as far, however, as classic times are concerned, plaster work became an artistic aid, reflecting

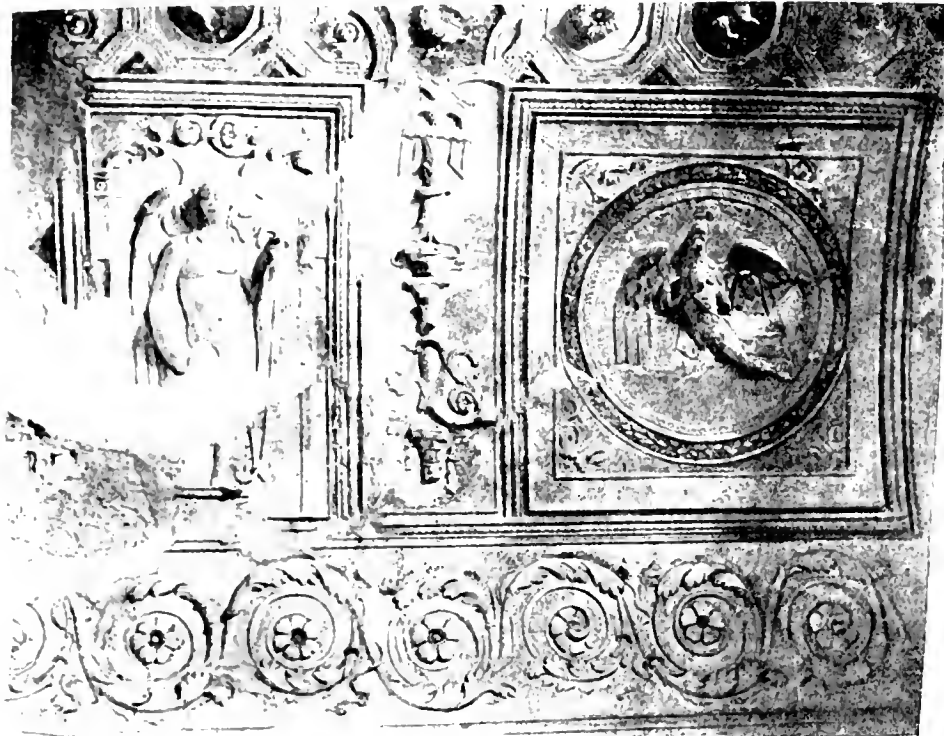

NO. 2.—STUCCO DECORATIONS, GREAT BATHS, POMPEII, FIRST CENTURY.

the general tendency of the times. Luxury begot lasciviousness and obscenity, and the moral, physical, and political decay of the Roman Empire led to its downfall, while the Puritanism begotten of the persecution of the Christians led to an iconoclastic destruction of every artistic thing, sacred and profane, and so ended artistic plastering in Rome. During Constantine's reign it passed away, and on his transfer of the capital of the Empire to Constantinople, what little building was then done then resulted in that Byzantine style of stiff, formal, plastic art which, though of archaeological value, presents nothing pertinent to the present subject. Julian "the Apostate," notwithstanding that he married Helena, the daughter of Constantine the Great, reverted from Christianity, and became a pagan about 380 A.D. He had amongst his household gods a statue of Apollo under the outstretched hand of which he daily bowed his head. Now this statue was of plaster (gypsum),

but it was most probably sculptured in this material, rather than cast, as we find no traces of any replica, nor does any word equivalent to piece moulding occur in the language of this time. Henceforward very little was done throughout the Empire until a new Rome was founded, and for more than a thousand years all relics of ornamental plaster work were buried and wellnigh forgotten. Materially, as a craft, it was debased; the old care in preparation had disappeared, and the drudgery of careless service replaced intelligent assistance to architecture and sculpture. As an art it was dead, buried under the ruins of the buildings it had adorned, so far as Rome, the whilom capital of the world, was concerned, and there we must leave it until we come to consider its resurrection.

There is, however, little doubt but that this Eastern removal of the Empire spread the art into the far East, and it is probable that the over-enriched plaster work of India, Persia, and other parts of the Indian Empires which are in question—a question we cannot yet enter fully into, owing to the very little knowledge we possess of their archaeology—is largely due to the dissipation thus effected. The Arabian and Moorish results of this were brought back to the Western world by the Moors in the early part of the thirteenth century, to whom we owe the splendid plaster work of the Alhambra described in Chapter XVI.

During the Middle Ages plastering existed only as a craft, and its highest function was to prepare a surface to be painted on. Sometimes it was used as an external protection from the weather, but rarely was it employed for direct adornment. Sometimes small ornaments were carved in plaster of Paris, but it played no important part in decorative art, excepting, perhaps, as gesso, though this belonged rather to the painter than the plasterer; nor was it until the commencement of the Renaissance in Italy that it showed any symptoms of revival.

After the long night of darkness which thus overshadowed learning and the arts, the dawn of a new era, to which we have given the name of the Renaissance, began. With the commencement of the fifteenth century old learning and old arts began to be studied, literature leading the way, as it always does, and their study was enormously facilitated by the discovery of the art of printing, and the consequent multiplication of the copies of the lore heretofore locked up in old manuscripts. We can glean somewhat of what was the state of the plaster-worker's art at that time by glancing at some of the old recipes which have been handed down to us in the notebooks of the artists of that dawning time. Amongst the foremost of them was Cennini-Cennino, a painter born about 1360, a pupil for twelve years of Agnolo Gaddi, of Florence (who died in 1378); towards the end of his long life Cennino wrote a book compiled from his notes of all recipes and directions for the conduct of all artistic processes known to him, and this book he finished on 31st July 1437—unfortunately dating it from “the debtors' prison at Florence.” He also gives us directions “how to take casts from the face of man or woman,” which is much the same as our modern process, and was doubtless that of Lysippus; but he quaintly remarks that “when you take the cast of a person of high rank, such as a lord, a king, a pope, or an emperor, you should stir rose water into the plaster, but for other persons it is sufficient to use cold water from fountains, rivers, or wells.” In taking a cast from this mould, he advises the addition of a little pounded brick. In this there is as yet no reference to piece moulding, and it is very doubtful if these processes were then known. The nearest approach to such a suggestion is contained in the instructions “how to take a cast of the whole figure of a man.” “In such case you must let the person stand upright in a box, joined together lengthwise, which will reach as high as the chin. Let a thin copper plate be placed against the shoulders, beginning at the ear and reaching to the bottom of the case, and bind it with a cord to the naked person, so as not to injure or press into the flesh. Cut four copper plates like this, and join them together like the edges of the case. Then grease the naked person, put him directly

into the case, mix a large quantity of plaster with cold water, and take care to have an assistant with you; and while you pour plaster into the case in the front of the man, let the assistant fill the back part at the same time, so that it may be filled to the throat. Let the plaster rest until it be quite set and dry, then open the case, separate the edges of the case from the copper bands with chisels, and open it as you would a nut. Withdraw the naked person very gently, wash him quickly with clean water, for his flesh will be red as a rose. With regard to the face, you may do that another time"! I do not expect a chance to cast from a living face would occur after such a process.

This may, I think, be taken as a merely theoretic instruction, showing more desire than facility, but is sufficient to show that piece moulding was not known to Cennino, if indeed practised by any one at his time. In another recipe he gravely bids any one wanting to take a cast of himself to spread a bed of wax about 9 inches deep on the dining-table and then lie down upon it, taking care not to disturb the mould when he gets up. From this mould he takes a plaster cast, and then carefully lies down on his other side and completes the mould!! Comment is unnecessary, and it is only from their negative value that these casting recipes of Cennino are worth remark, showing that the desire for such a process was greater than its achievement. The real utility of his recipes, in a positive direction, are those in which he treats of gesso and other painter's usage of the plasterer's material. Of lime stucco he says nothing, and all his remarks relate to plaster obtained from gypsum found at Bologna, or Volterra, whence comes that fine white translucent alabaster of which small figures, vases, and models of buildings are made to this day. A more practical recipe, and one relating to stucco, is found in the Marciana MS., which is preserved in the Library of S. Mark, at Venice, and was written about 1503.

This is headed as "tried by Master Jacopo de Monte S. Savino, the Sculptor." "Admirable stucco for making and modelling figures and for colouring them, and it resists water. Take of finely-pounded travertine 5 lbs., and if you would have it finer and more delicate, take fine marble instead of travertine, and 2 lbs. of slaked lime, and stir and beat them well together like a fine paste, and execute what works you will with it, either by forming it with your hands, or in moulds, and dry it in the shade. And if you wish to colour it white, when the work is dry enough to be tolerably firm, but not quite dry, grind white lead with water in the same way as colours are ground, and the flour of sifted lime, and apply it with a brush, and it will be very white and will effectually resist water. And if you wish to colour it with other colours, let the work dry perfectly and then colour it; but these colours will not resist water like the white. If, then, you wish the colours to resist water, apply on the work the above-mentioned composition and paint with oil colours."

This brings down the literary notice of our subject to the period of Raphael and the great revival of stucco work, before considering which we must first cast a backward glance at some evidences of pre-Raphaelite use of it. We have actual evidence of its use by Donatello, who practised it, and it is on record that he used pounded brick and glue with his stucco, and from this many of his stucchi pass as terra cotta. No doubt his object was to avoid the risk and distortion by baking his clay model. There is a group of the "Entombment" over the sacristy door in the Church of S. Antonio at Padua, which was formerly considered to be in terra cotta, but is now proved to be of this brick-dust stucco. There are medallions of the Four Evangelists in true stucco in the sacristy of San Lorenzo at Florence. In South Kensington Museum there is a large stucco plaque with a low relief of the Virgin and Child, and many others are known. Now Donatello died in 1466, proving that in the first half of the fifteenth century stucco was making progress. In South Kensington Museum there is a very fine relief of the Virgin and Child surrounded by angels,

exhibiting very marked Gothic features in its accessories. This has the date 1430 attributed to it. There, too, you will find many busts of very excellent modelling and great technical skill, all done with the grey stucco. Indeed, there is plenty of evidence that with the advance of the revival of all the arts stucco was yearning to take its wonted place beside them. Bramante, the chief architect of his day, was uncle to Raphael, and inspired his nephew with an enthusiastic love for architecture and archæological research. He, Vasari tells us, invented "a mixture of lime" with which to decorate the exterior of his houses with festoons and friezes of foliage, and one of his last works was the building, in 1513, of Raphael's own house, which was decorated with stucco made according to the recipe from the Marciana MS., Jacopo Sansovino being one of the stucco modellers there employed. Bramante died in 1514.

Other experimenters were at work in other parts of Italy, for the endeavour to revive the lost art of modelling in stucco was becoming general, and in Bologna Alfonso Lombardi had achieved a pre-eminent success in the renewed art. Not only did he model many portrait busts in stucco, and amongst them that of Emperor Charles V., which he did whilst the Emperor was sitting to Titian for his portrait, but, aspiring to greater things, he executed a large group of the death of the Virgin in a very hard stucco, which was so admired by Michael Angelo, himself a stucco worker, that on seeing it he exclaimed, "If this stucco could only become marble, it would be bad for the antique statues." Lombardi modelled many other statues in Bologna which were larger than life, all executed in the grey lime stucco, and Cicognara styles his figure of Hercules as the finest colossal statue of the century. About the same time Andrea Verrochin really founded the art of piece moulding in Venice, and brought the casting of plaster to such a pitch of perfection that reproductions of ancient and modern works were easily obtainable, and thus formative art secured an impulse the movement of which still continues.

In 1509 Raphael came to Rome, and was in 1515 appointed by Leo X. Director and Inspector of the search for the buried remains of Ancient Rome; and for this purpose determined, in 1518, to unearth the remains of the Golden House of Nero, then supposed to be the Baths of Titus, and which for five hundred years had been buried under their own decay. Here was a great discovery and surprise. Not only were there found painted chambers, fostering the new growth of "grotesque" ornamentation, so called from its abounding in the newly unearthed grottoes, but, more cherished than all else, abundance of modelled stucco decorations, which had survived still better their long entombment, astonishing Raphael and his attendant, Giovanni da Udine, by their hardness and brilliant whiteness. This discovery was most opportune, for the decoration of the Loggia of the Vatican was just then under consideration, and Udine set himself to work especially to find out the process and the manipulation. He says he made many experiments and re-invented the process; but as Raphael, who was not a Latin scholar, had just then had a special translation of Vitruvius into Italian made for his own study, I am disposed to think this also was exhumed about the same time. Be this as it may, the newly found stucco duro became at once the rage. With the Vatican for a cradle, and Pope Leo X. and Raphael for its sponsors, its success was ensured; but unfortunately those mephitic vapours engendered in the soil which so long had hidden this brought disease with them, and there is but little doubt that Raphael's death on the 6th of April in the following year is due to the energy with which he sought for this buried art in the miasmatic vaults which had preserved it. By his last testament Raphael left the completion of his decorative works to Giulio Romano and Gio. Francesco Penni, who, for the stucco portion of these, allied themselves with Giovanni da Udine, its re-inventor, and continued the work at the Villa Madonna, then being done for Cardinal de Medici, a cousin of Leo X., and who succeeded him as Pope in 1523.

Plastering—Plain and Decorative.

You can form an idea of what the modelled stucco here was by examining a very beautiful model of it which you will see in the South Kensington Museum ; but of the vastness of the Villa and the richness of its surroundings it would, in a short notice, be impossible to give you an impression. Unfortunately it was partially ruined before it was completed, and suffered from the barbarities of the soldiers during the sack of Rome by the French in 1527. That drove Udine to Florence, where he was much employed by Cosimo de Medici and Michael Angelo, but in his old age he returned to Rome, working to the last on the Loggia, on which, as a stucco worker, he began, and where he died in 1564. He is buried in the Pantheon, close by the tomb of his loved master, Raphael, and, as says his biographer Vasari, "we may believe they are now met together in eternal blessedness."

Giulio Romano went in 1524 to Mantua to carry out work for Duke Frederic Gonzaga, which Raphael had, before his death, promised to undertake, and there raised up an important school of stucco workers, who we shall see influenced the whole of Western Europe. Pierino del Vaga, painter and sculptor, who was one of Raphael's staff of stucco workers, having begun life as a "hawk boy," went to Genoa, where he founded a great school under the patronage of the Doria family, but returned to Rome when peace was restored, and worked on the Scala Regia, and many of the principal rooms in the Vatican. Jacopo Sansovino, one of the first essayers of the new-found art, went to Venice, where he fostered it, making many statues and other large works,

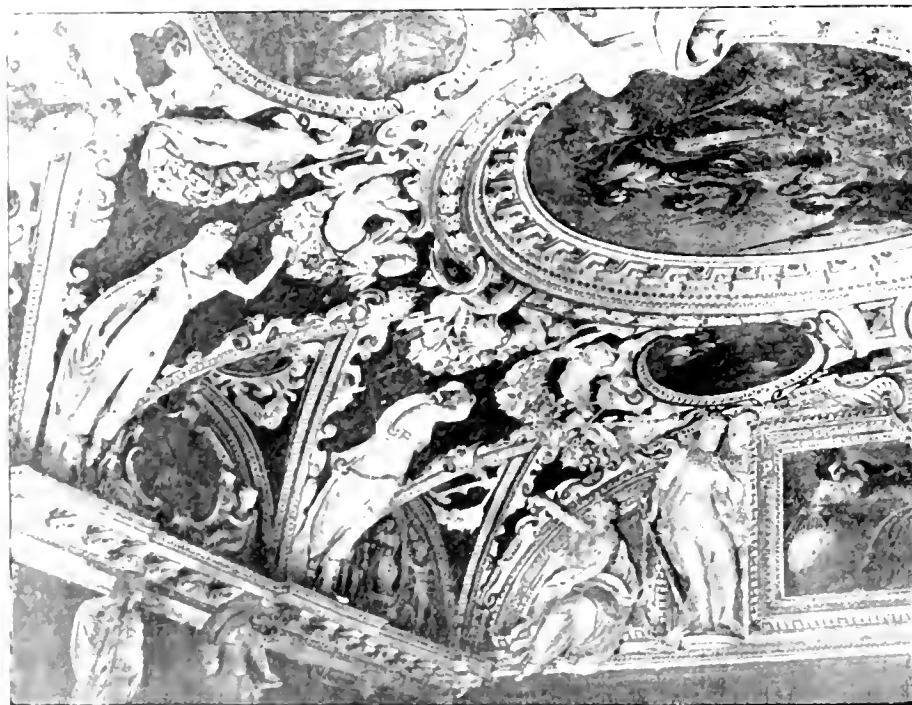

NO. 3.—STUCCO CEILING, DUCAL PALACE, BY A. VITTORINO, 1570.

training up a large school there, and in it his most celebrated pupil, Alessandro Vittorino—a man to whom nothing was impossible. He was, in fact, too facile. But as a proof of his power you can see on Plates III. and IV. some of his work in the Palazzo d'Albrizzi in Venice, evidences of his ingenious and daring skill. Of a less hazardous and more restrained character is his vaulted

ceiling, shown on Illustration No. 3, from the Ducal Palace at Venice, executed about 1570, but each example of his skill is wonderfully varied, and in all phases of decorative art he was an exuberant master.



No. 4.—STUCCO CEILING, SCALA DI GIOVE, FLORENCE, BY A. VASARI, 1569.

The school which Udine had founded at Florence produced great results; Vasari, the biographer of so many artists, went there to work on the Pitti Palace in 1555, and of the interior work of that school you can form some idea by referring to Illustration No. 4, where you will find a portion of the ceiling from the "Scala di Giove," which Vasari commenced in 1559. There are many other grand ceilings in this same palace, with marvellous stucco work designed either by Vasari or the architect Ammanato, and executed by the school Giovanni da Udine established. But the most interesting example of external work, as demonstrating the perfect composition of the material and its great durability, is shown in the present state of the pillars of the courtyard of the Palazzo Vecchio there (see Plate V.). These were done in 1566 under Vasari's direction, and as the names of good workmen are as worthy of record as are those of good designers, I, in praise of their honest and perfect workmanship, give them here. They are—Pietro Paulo Minocci, who afterwards settled in Parma, where he did much good work, of which some still exists; Ricciavelli da Volterra, who afterwards joined himself to Pierino del Vaga at Genoa and in Rome, and ultimately came to England; Sebastiano Tadda, whose relative Francesco was a noted worker in porphyry; and Leonardo Marignalli, of whom I have not been able to trace anything further. Their monument is in their work, which you will find on plaster, in Florence, and which, after five hundred years, hands down the record of their craft almost as sound as the day they did it. With what they did it demands particular attention, and by a fortunate accident we have in a notebook

still preserved in the Bodleian Library at Oxford, kept by Pirro Ligorio, a joint architect and coadjutor with Michael Angelo for S. Peter's at Rome, and which contains the exact recipe written just about this time. "Take," says he, "3 parts of pounded Parian marble, easily got from among the ruins in Rome and from broken statues; add 1 part of lime which is to be perfectly slaked by letting it lie in a heap covered with pozzuolana and exposed to the sun and rain for at least a year. The lime is to be made from pure white marble, not from travertine, or any other stone which is full of holes and yellowish in tint; mix a day before with sufficient water on a tile floor. The first coat to be mixed with coarsely pounded, and the finishing coat with finely pounded white marble." Now let us examine scientifically the rationale of all this. Firstly, the lime is pure carbonate of lime; it was naturally burnt with wood fuel, and consequently was free from all those sulphureous and other deleterious compounds inseparable from coal firing. The air slaking of it prevented the too great absorption of carbonic acid which is obtained by the free use of water, and which rather retards than assists the setting of the stucco. Then the pulverisation of the unburnt mortar introduces a fine crystalline substance into this identical chemical composition when as yet amorphous in structure. These minute crystals induce the formation of a general crystalline structure until the final and most permanent form of all mineral substance is achieved. Thus the wisdom of the ancients achieved that which is only just dawning on the modern world of science, and the as yet but partially understood question *why lime sets*, is full of thought seed for scientific inquiry—seed for us to propagate, and so to carry still further the lore and practice of the plasterer, and to cultivate it into fruitful knowledge. You will have remarked the absence of hair in any of these old formulæ; the rapidly induced crystallisation seems to have rendered this unnecessary, for the introduction of any animal substance into plaster is an unscientific error which these old plasterers avoided.

After this digression, which these Florentine plasterers have brought about, let us return to Mantua, where we left Giulio Romano in 1524. He there did works in painting and stucco which were renowned throughout Europe, and his school of stucco workers achieved such a reputation that Francis I. wrote to Duke Frederic Gonzaga praying him to send him some young man able both as a painter and a stucco worker to assist him in decorating his new palace at Fontainebleau. This was in 1536. After conference with Giulio Romano, the Duke sent him Francesco Primaticcio, the son of a wealthy Bolognese merchant whom a love of art had seduced from the ways of commerce. He gathered round him a large staff of modellers, of which he became superintendent, and together they, according to Vasari, "did the first stucchi ever executed in France." If the pure white stucco is meant, this was true, but there was in France a considerable attempt to model in the ordinary plaster before this, and many of the fine Gothic-hooded chimney-pieces in the chateaux are modelled in plaster on wooden cradling. At the Gros Horloge at Rouen there exists some well-modelled plaster, and there is evidence of the existence of a school of ornamental plaster workers in the valley of the Seine some years before Primaticcio's advent. At Fontainebleau, however, he did most noble figure work, much of it being considerably over life size; long graceful figures, which formed the canon for the sculptors of the French school of Gougon, Pilon, and their followers, such as you see in Illustration No. 5. Of course if Francis I. could thus emulate the arts of Italy in their then most fashionable phase, his great rival, our Henry VIII., could not be outdone by him. Already Cardinal Wolsey was busy fostering the Renaissance in England, and Henry sent, through his ambassadors, for those who could outvie the Italians in the service of the French king. By these means he collected many artists of renown. Amongst these were Luca and Bartholomew Penni, brothers of that Giovanni Francesco Penni whom Raphael left fellow-executor with Giulio Romano

for the execution of his incompleting designs. Luca, who preferred painting to plastering, did not stay long here, but deserted the king and went to join Primaticcio in France, for plasterers who could model in stucco were the subject of much diplomatic correspondence in those days. Bartholomew was here at any rate until 1539, as records of payment to him are recorded in that year. Gerome of Trevisa, who, Vasari tells us, "made many ingenious devices and one honourable house for the king's use," came, and was so much admired by King Henry VIII. that he gave him a stipend of 400 crowns a year. He was killed at the siege of Boulogne in 1544. Nicholas of Modena left Primaticcio, from whom he was receiving 20 livres a month, and came to help us. There was also Toto del Nunziato, whom the old account books call Anthony Toto, and who was a wax modeller at Florence, whence "sundry merchants carried him off to England, where he made all manner of works for the king, and particularly the principal palace." Now this principal palace was that of Nonsuch, which was so-called because it had no equal; it was built at Cheam, between Sutton and Epsom, but unfortunately not a vestige of it now exists. It was a very large and sumptuous pile, containing two quadrangles, and built in the half-timbered style, then prevalent in England; it was never quite finished before the king's death, but existed for more than a century, sufficiently long for record, of what these plasterers did there, to have been taken by those who admired its wonders.

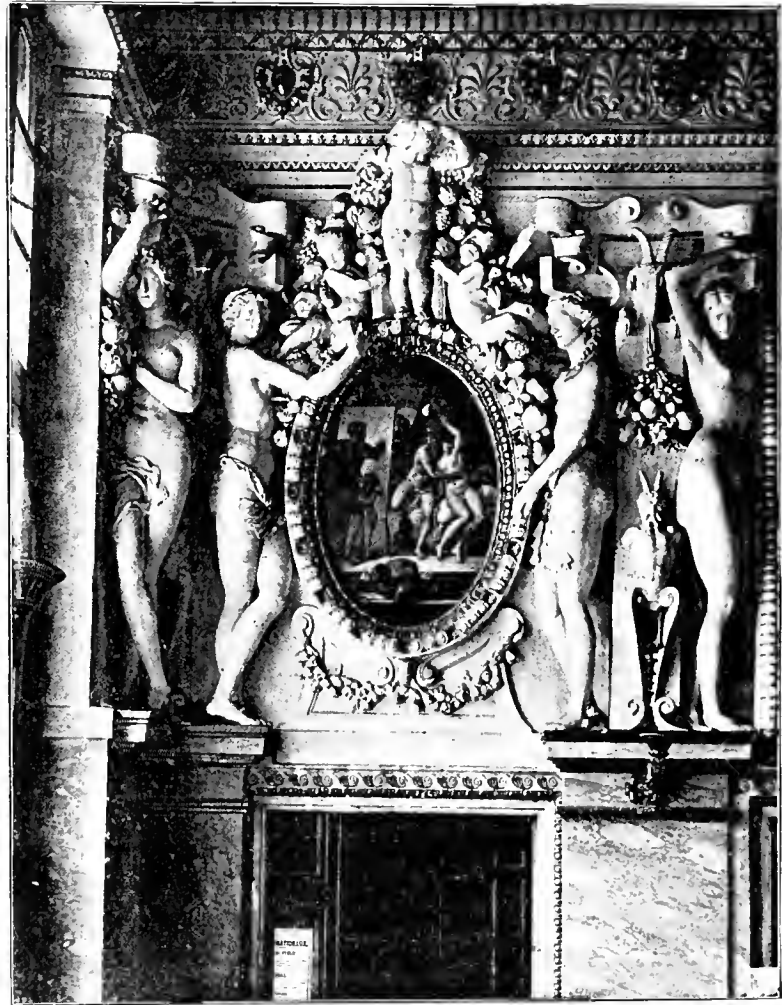

No. 5.—STUCCO DECORATION, PALACE OF FONTAINEBLEAU, BY PRIMATICCIO, 1536.

The Duke of Saxe-Weimar, who saw it in 1613, tells us that "the labours of Hercules were set forth on the king's side, the queen's side exhibiting all kinds of heathen stories with naked female figures;" and John Evelyn, who saw it in 1665, says: "I took an exact view of the plaster statues and *bas relievos* inserted between the puncheons of the outside walls of the court, which must have been the work of some celebrated Italian. I much admired how it had lasted so well and entire from the time of Henry VIII., exposed as they are to the air, and pity it is they are not taken out

and placed in some dry place—a gallery would much become them. They are *mezzo-relievs* the size of life.* You may form some idea of them by turning to the illustration of Primaticcio's work at Fontainebleau. Unfortunately we had not the white marble here to mix with the lime, so we could not obtain the crystalline quality that preserved the old Italian stucco, but we learn from a manuscript note by P. le Neve that necessity was the mother of invention, and that "it was done with rye dough very costly." This would dry very slowly, and give toughness to the stucco whilst being modelled. I have tried it, and found it pleasant to work with, and it dries a beautiful old ivory colour. Having thus brought the classic art of modelling in stucco into the English Renaissance, it will be well to pause awhile and take a brief backward glance at what English plastering was before the advent of this new fashion.

What the state of plaster working was before the Romans, under Julius Cæsar, came, we have no knowledge. We know that the ancient Britons used houses built of hurdles plastered inside and out with mud—the old "wattle and dab," in fact, much of which is still done in the West of England. Of course the Romans brought their arts with them, and during their four hundred years' stay introduced the arts and luxuries of the capital, as the numerous ruins of their buildings show. The Anglo-Saxons plastered many of their buildings inside and out, as the illumination in their MSS., and some evidences of actual work, including perhaps the plaster work on Anglo-Saxon masonry at the Church of Avebury in Wilts, demonstrate. The Normans were a highly skilled and civilised people, but we have no written records of *how* they plastered; that they did so is proved, by existing pictures showing painted walls of great richness, which could only be done on a finely wrought field. All this was, of course, the ordinary lime stucco, for the use of "plaster of Paris" or calcined gypsum was unknown in this country until the time of Henry II., who, on a visit to Paris in 1154, so admired the superior whiteness and fineness of the walls, that he introduced it here. But plaster or lime stucco was as yet in England only considered as a structural necessity, and not as a decorative adjunct; that its fireproof qualities and sanitary influence were known is shown by the edict of King John, who, after the great fire which destroyed the timber-built London Bridge in 1212, issued an edict that "all shops on the Thames should be plastered and white-washed within and without. All houses which till now are covered with reed or rush, let them be plastered within eight days, and let those which shall not be plastered within that time be demolished by the aldermen and lawful men of the venue overseers. And let all houses in which brewing or baking is done be plastered within and without, that they may be safe from fire." A contract for plastering, dated 1317, exists, wherein Adam, the plasterer, a citizen of London, agrees with Sir John de Bretagne, Earl of Richmond, to find "plaster of Paris" wherewith to plaster his hall well and befittingly within and without. At Clare, in Suffolk, is a fine old house (Plate VI.), stated to be dated 1473, a date I am somewhat sceptical about, with some very fine plaster work modelled in relief, with figures and scroll work, but which is evidently of a later period. In 1519, Hormann, in his "Vulgaria," says: "Some men will have their walls plastered, some pargetted and white limed, some rough cast, some pricked, some wrought with plaster of Paris." In fact, the plasterer's and pargettor's art and craft had now become of such importance that it was formed into a separate Guild and Company in London in 1501 by Henry VII., who granted them "the right to search and try and make and exercise due search as well, in, upon, and of all manner of stuff, touching and concerning the art and mystery of pargettors, commonly called plaisterers, and upon all work and workmen in the same art."† It is noteworthy that here pargettors are "commonly called

* This charter, having been frequently renewed with varying powers, still exists, but the only trade function the Company now performs is the granting of £25 annually to the successful candidates in the examinations conducted by the City and Guilds of London for Technical Examination.

plasterers," but in earlier times plasterers were commonly called pargettors. Parging was then plastering, and I am inclined to think that when the larger surfaces of the walls admitted the use of the "rule" and the "float" the distinction began. We still parge a chimney-flue, in which neither rule nor float can be used but only the trowel. In the old timber-framed houses the want of truth in the carpentry compelled the plaster to be laid with the trowel, hence we say they are pargetted, not plastered, and the modelling which so frequently enriched them was done with the trowel, and still bears the name of pargetry. We have thus seen how the taste of the time was prepared for the introduction of the plasterers who worked in the Italian mode introduced by Henry VIII. These kept continually coming until the death of their royal master, and having found the way here remained for many years after. Thus we have a De Rudolphi here in 1550, who was most probably a relative of Bartholomew Rudolphi, who worked in Venice and Padua, where he married the youngest daughter of Tiziano Minio, also a stucco worker. She likewise prosecuted the art, and is the only female stucco worker I have met with any account of. Rudolphi and his wife took service with Sigismund II., King of Poland, leaving their only son here. Leonardo Ricciarelli, one of those who worked at the Palazzo Vecchio at Florence, came here in 1570, and Luca Romano, who had worked with Primaticcio at Fontainebleau, came here after Primaticcio's death, and I have found his name as employed in England in 1586.

The English plasterers quickly learned the operative lessons these Italians taught, though they never learned the skill of their arts of design; nor indeed was this necessary. The exigencies of English houses were different from those of Italian palaces, so they fitted their work for its purpose—a purpose never applied in any other country—that of covering a flat ceiling in a room of moderate height with a suitable plastered decoration. That this lesson was early learned is shown by some notes we have of the career of Charles Williams, the first English plasterer of whom we have any record as a practiser of the new art. He had most probably been one of those who were employed at Nonsuch; at any rate he had travelled in Italy, and wrote in 1547 to Sir John Thynne, then engaged in building his house at Longleat, in Wiltshire, offering his services in supplying internal decorations upon "the Italian fashion"; and among the papers at Longleat are two letters from Sir William Cavendish and his wife Bess of Hardwick, begging from Sir John the use of this "cunning playsterer," who, they hear, had made "dyvers pendants and other pretty things, and had flowered the Hall at Longleat," to do like work for them at Hardwick Hall. There is but little doubt the fragment of the frieze still remaining on the wall of the old house is his handiwork. If so, the "Italian fashion" he wrote of is more applicable to the handicraft than the design, and it is not improbable that the great frieze representing a stag hunt which yet adorns the Council Chamber was executed by those who had studied under his direction. Of course, during the short and troubled reigns of Edward VI. and of Queen Mary, when England was in the throes of the internecine strife of politics and religion, but little decorative work was done, nor until the long and more prosperous time of Queen Elizabeth did the English plasterer have the opportunity of showing his prowess.

He had not attempted to vie with the more artistically educated foreigners, but had evoked for himself an especial decoration of his own, based in some degree on the familiar groining which had strengthened and ornamented the stone roofs with which he was familiar. Geometric rather than freehand designs were his first essays. These at first consisted of interlacing squares, having radial ribs from their intersecting points, and as he grew bolder in his work these radial ribs became arched, and from their junction depended a pendant more or less ornamented, such as you may see copied, in South Kensington Museum, from a ceiling at Sizergh Hall, Westmorland, where you will

find it in conjunction with fine Renaissance inlaid wood work. Frequently, modelled foliage replaced these radial ribs, giving the effect of a Gothic diaper to the ornamentation of the ceiling, as in that at Burton Kirk. These simpler ceilings relied greatly on colour and gilding, and Edmund Spenser, the great poet of the Elizabethan era, sings in his "Visions of Bellay" of halls where

"Gold was the parget, and the ceiling bright
Did shine all seadly with great plates of gold:"

and the plasterer and the painter were united, not only in their work, but in their person,—so much so, indeed, that the elder Company of the Painter-stainers was compelled to appeal to the Parliament in the latter years of the Queen's reign to restrain the plasterers from using oil colours, and they were ultimately, after considerable discussion during two Parliaments, confined to the use of distemper painting only. But it was not the encroachment of the Plasterers' Company by painting alone which depleted the trade of the Painter-stainers. The purity of the white stucco then introduced, and the decline of the mediæval sense of colour in favour of this white homogeneous purity, had its effect also, and this was enforced by the richness of the plastering introduced. The geometric arrangement was no longer confined to straight lines. Curvilinear, interlacing, and knotted forms were introduced as at Losely (Plate VII.). The ribs were no longer of plain moulding, but embossed with running ornaments, modelled or impressed, and as the art grew, even the geometric basis was abandoned, and a free adaptation of scroll work of very large dimension was adopted. The ceiling was not sufficient for the plasterer, even though, as at Charlton in Kent, it was 115 feet in length, but his art encroached on the walls, and a deep frieze, filled with relief ornament of figure work and emblems, extended itself between the wainscot and the main cornice, as at Crewe Hall, where some of the friezes are nearly 6 feet deep, and the Hardwick Hall example, before quoted, is 11 feet deep. With such as these the art of painting could not then compete.

The over-mantels of the large fireplaces were filled with subject work or armorial bearings, and henceforward the plasterer was the supreme decorator; in fact, he usurped the province of both the painter and the sculptor, and revelled in the large mansions which sprang up all over the country during the latter years of Queen Elizabeth's reign and the early ones of her successor. External walls were sometimes covered with pargetry, like the cottage at Wyvenhoe, detail of which is shown in Illustration No. 6; and the string courses, cornices, and other external architectural features were covered with plaster as at Hollington, Kent, and Little Charlton, near Woolwich,—in fact there is hardly a single county in England or Wales which does not yet retain the evidence of the artistic powers of the plasterer. Some places, notably the older towns, once commercial centres, but now somewhat decayed in wealth, have by that absence of growth preserved much of their wonted glory for us, such as Yarmouth, which abounds with rich plaster work of the character you will see on Plates VIII., IX., X.

The early years of James I. were very fruitful ones to the plasterer, and in Bramshill House, Hampshire, built in 1603, there are several ceilings, one of which you will see on Plate XI.; but one of the finest mansions of this time is Audley End, where almost each room exhibits a very varied design of very noble character. This house was built by Thomas Howard, Earl of Suffolk, between 1603 and 1616. The principal room measures 66 feet by 30 feet, and its ceiling gives its name to it, for it is divided into thirty-two compartments, each of which is occupied by modelled groups of fish or other aquatic subjects, hence its name of the "Fish Room." These subjects are divided by broad flat ribs having very boldly arched pendentives at their junction, and which are

covered with the most delicately modelled ornament, partly impressed and partly hand wrought. The study, a room 40 feet by 24 feet, has a singularly convoluted pattern, one quarter of which you will find on Plate XII., with most delicately wrought pendants of varied design at the principal points. This design was evidently a favourite one, for there are several replicas of it existing, as at Charlton in Wilts, and sundry other places, helping to prove that these ornamental plasterers travelled from place to place, taking their patterns with them. But the triumphant example of the plasterer's work here is found in the library, a large room 60 feet by 30 feet. This area is quartered, so that each quarternal cartoon is 30 feet by 15 feet, and the whole main form is one large oval interlaced with, and intersected by, other curvilinear lines so beautifully drawn that there is not one lame or halting one in the whole of this large area—a wonderful piece of setting out, showing not only great skill in design, but most accurate eye and hand in its execution. Interspersed with these fine main lines is most delicately wrought foliage work, with here and there a winged fairy such as might have been an attendant on Titania; indeed, this ceiling has such wonderful refinement and poetic grace that it may best be described as a plasterer's translation of Shakespeare's "Midsummer Night's Dream." There is a beauteous variety of detail throughout the whole, no formal repetition, but a rhythmic balance is maintained, giving an emphasis and a cadence beyond expression, and I know of no other ceiling of this date so pure and so restrained. A much richer, though not so graceful a one, is found on Plate XIII., from the state bedroom of Boston Manor House, showing the main ribs highly decorated, and illustrating the mode of setting out such ceilings by quartering. On this plate is also shown a section of one of the pendants of the same ceiling—Fig. 1,

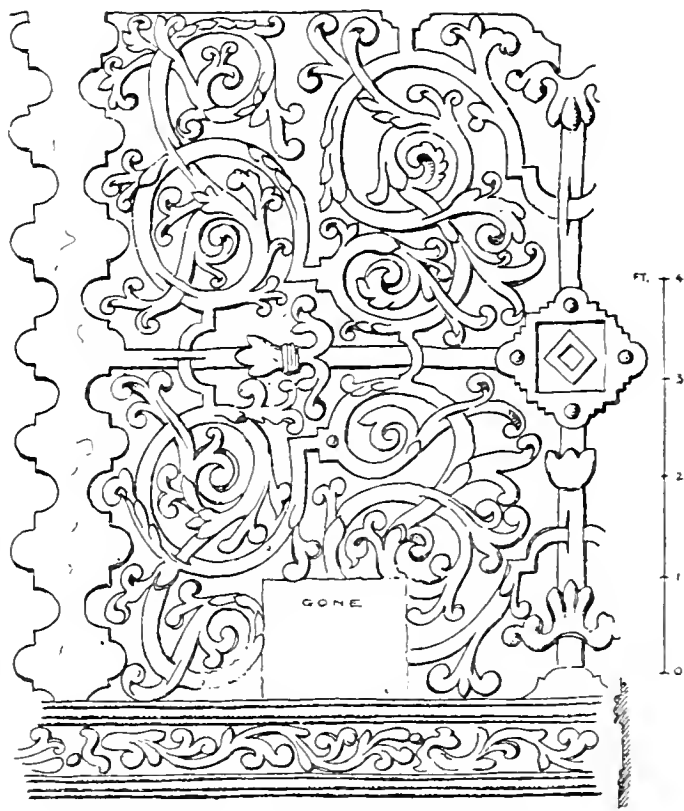

No. 6.—EXTERNAL PLASTER WORK, WYVENHOPE, SIXTEENTH CENTURY, together with a frieze from Bowery Hall,

Edmonton (Fig. 2). Of the external modelled work done at this time, it may suffice to mention the fine old house at Maidstone, which bears upon it the date of 1611, and where large panels of scroll work, interspersed with the royal arms and the device of the Prince of Wales, fill in the spaces between the beams. Bishop King's House at Oxford, 1620, the George Inn at Audley End, and abundant instances exist to prove its popularity.

Scotland having now annexed the kingdom of England, annexed its plasterers. At any rate their patterns seem to have been appropriated, for they all belong to this epoch, and there does not appear to be any evidence of a national growth in Scotland, such as exists in England.

Probably the earliest of these Scottish examples is that of Craigievar, Aberdeenshire, which

dates from 1611, when the castle was purchased by William Forbes, who "having made much wealth by trading in Denmark," "he plaistered it very curiously," with the result shown on Plate XIV., adapting the usual pattern, common in many parts of England, to the arched and groined ceiling. Similar ceilings exist at Moray House, Edinburgh, one of which is shown on Plate XV. Both of these examples show the ribs enriched with modelled ornament, and give excellent impressions of the effect of this treatment. A little later example of a similar pattern comes from Winton House, Midlothian, done about 1620 (Plate XVI.). The design and details of all these three are so similar that it is more than probable that they are all the work of the same school of plasterers, whether they be Scottish or English. At Pinkie House there are many plainer ceilings, partaking in form the character of those found in the houses pulled down in Lime Street, London, and shown on Illustrations 7, 8, 9, proving that there was little or no

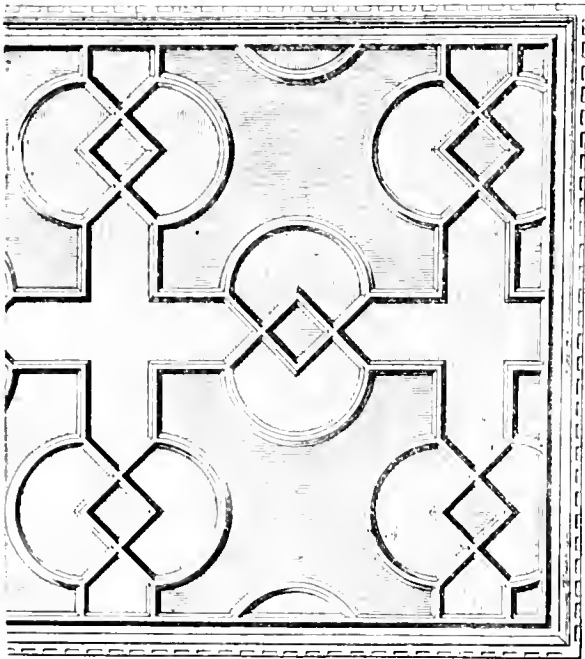

NO. 7. —PLASTER CEILING, LONDON, 1620.

difference between the two halves of the kingdom. Under Charles I. the old style of his father at first prevailed, and so late as the Survey of the Manor of Wimbledon in 1649 we read of a room in which "above the wainscot is a border of fret or parge work wrought: the ceiling is of the same fret or parge work"; and many of the older houses yet there remaining have good illustrations of this survival of the older character. Yet the advance in the study of Renaissance architecture under Charles I., greatly due, no doubt, to the influence of Inigo Jones, reduced this redundance of ornament, and ceilings of a plainer character, but still retaining the ribbed formation, prevailed, such as that shown from Carnock Castle, Stirlingshire (Illustration No. 10); but gradually even these ribs disappeared from the ceiling, which was once again relegated to the painter (fostered by the works of Rubens and other imported painters) rather than to the plasterers; but the unsettled state of the kingdom, and the

Puritanic worship of plainness which set in, and continued during the Commonwealth, were well-nigh destructive to both, nor until the Restoration of Charles II. was either enabled to revive.

Born of a French mother, passing his youth chiefly abroad, the king returned to his devastated native country without any love for its national arts. The older or the wealthier families were requisitioned, repudiated, and ruined during the past troubles by one side or the other, and not unfrequently by both, so there was but a mere tradition of the old art left, yet sufficient remained to resuscitate it in a new fashion. This was enhanced by Sir Christopher Wren's visit to Paris in 1695, where he particularly noticed the plaster work done by Van Ostel and Anoldino, "plaisters who perform admirable works at the Louvre," and refers to "the marble meal as the old and still the modern way of stucco work in Italy." Fostered by its new masters, the art took a floral motive for its use, and the illustration (Plate XVII.) Mr Millar provides (for the use of which he has obtained the especial permission of the Lord Chamberlain) is an excellent specimen of the

plasterer's art of the time. This is from Holyrood Palace, where it forms the ceiling of the principal staircase, and is about 24 feet square, consequently the figures in the angles representing Fame, Glory, Force, and Power are rather more than life size. The floral wreathings are full of the most delicate and beautiful modelling, the work of Italian plasterers, whose names are inscribed upon the plaster, a fact noticed by Mr Millar when as a youth he worked on its repair. At Astley Hall, near Chorley, Lancashire, there is a very fine floral ceiling, enriched with flower and foliage, surmounting an elaborate frieze and cornice of figures and festoons; and in the Church of King Charles the Martyr, at Tunbridge Wells, there is a very good ceiling, with a large hemispherical dome in the centre, having a very boldly modelled wreathage of foliage and flowers in alto-relievo, with cherubs' heads, palm branches, and conventional foliage in its minor accessories, and an adjacent ceiling,

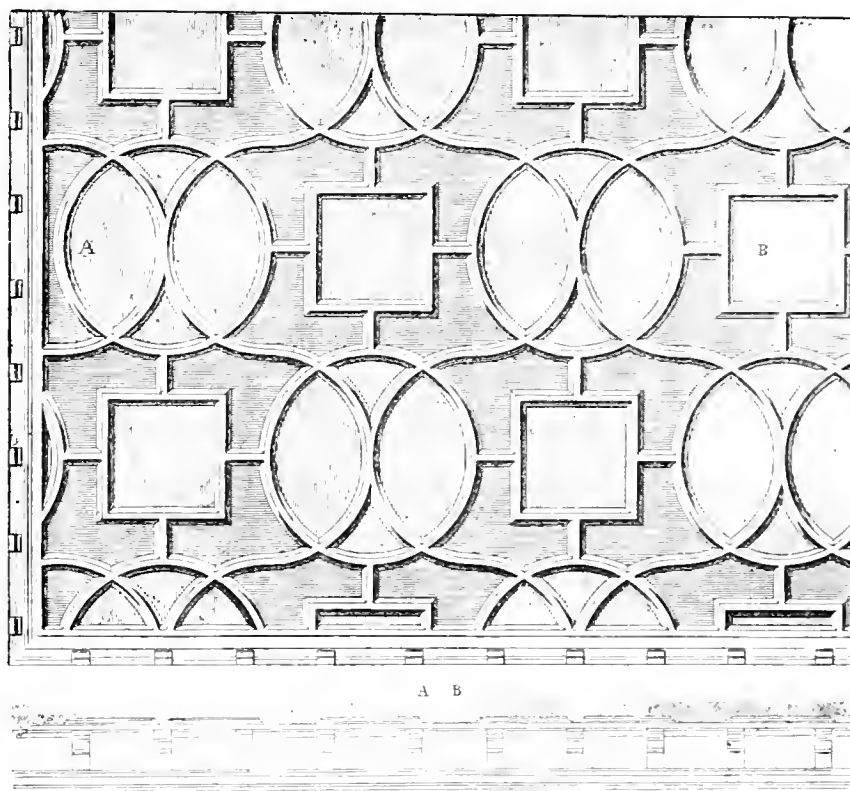

NO. 8.—PLASTER CEILING, LIME STREET, LONDON, 1620.

amongst cherubs' heads and palm branches, bears two dates, 1682 and 1690. These were done by John Weatherel and Henry Hoogood, who in those two years were paid £190 for their work. Similar plaster work, evidently by the same hands, was done at Groombridge Place, in the vicinity. Of course we have not much in London of the early part of Charles' time—the Great Fire destroyed the old, and the Great Plague arrested the new; but there is a very beautiful specimen in St Mildred's Church, Bread Street, the ceiling of which contains a central dome supported upon arches; the cornice, marking the springing of the dome, has a very rich band of fruit and flowers, the pendentives are filled with well-modelled laurel branches, and rosaces and palm branches fill the panels in the arches. Once it had a band of cherubs circling round the foot of the dome, but these have been removed.

One of the most remarkable monuments of the plasterer's art in external work is "Sparrow's House," at Ipswich (Plate XVIII.), which was done in 1683. The house itself is about a century older, and there is very interesting internal plaster work, together with some in an exterior court, of earlier date, which is very good, but its chief glory is on the main front, which was apparently redecorated in consequence of the visit of "the Merrie Monarch" to Ipswich in that year. Here we have modelled groups of the four quarters of the globe, with their emblems, together with a large figure of Atlas bearing the globe itself. There are festoons of foliage, St George and the Dragon, a grand escutcheon of the royal arms, processional and pastoral scenes, making this well-preserved house veritably a national monument; and Ipswich is worthy of a plasterer's pilgrimage, as he will find much other evidence of the past history of his art and craft in this quaint old port. French fashions, however, reigned supreme during the latter portion of the Stuart dynasty, and the influence of the style of Louis XIV. made itself prominent not only on the ceilings, but on the walls, where raised plaster panels with ornamental heads and bases began to prevail. This was strongly emphasised by the building of Montague House, Bloomsbury, the initiative of the British Museum, by Robert Duke of Montague, who was our ambassador to the

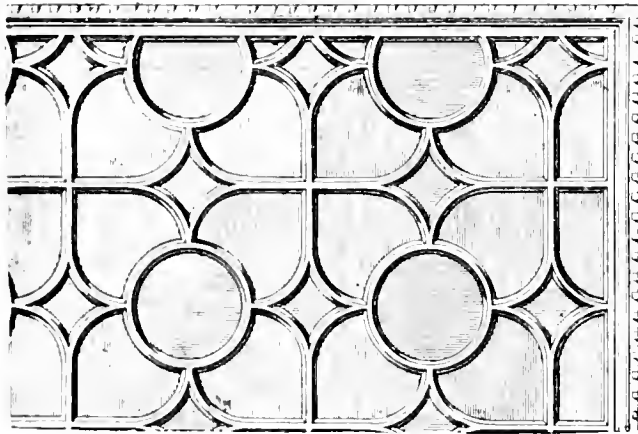

NO. 9.—PLASTER CEILING, LONDON, 1628.

court of Louis XIV., and who brought over Pierre Puget from Marseilles for his architect. Puget was brought up as a wood carver in a shipbuilding yard, and decked everything with flowers, for which he largely used stucco. Much of his work was delegated to and done by Monnoyer, a flower painter and modeller, and henceforth naturalistically treated wreaths and festoons of flowers became the prevailing ornament, often very delicately modelled in stucco or carved on wood by Grinling Gibbons and his school, thus creating the so-called "Queen Anne style," which is much more talked about than understood, and which really

ran through the reigns of William III. and his successors until George II. Under their influence the ceilings became divested of other panelling than a broad margin surrounding it, filled with flowing ornament, and often with rounded or incurved angles; the cornice became of small importance, the frieze had disappeared, and a deep cove, plain or ornamental, replaced both. A good example exists at Drum House, Midlothian, where there is also an example of the later and richer form of this phase. An excellent specimen of this style applied to a vaulted ceiling is shown on Plate XIX., in the work of Arturi and Baggutti on the ceiling of St Martin's-in-the-Fields, executed about 1722, and which, apart from the ornamental detail, is an excellent specimen of the plaster work of the period. Arturi and Baggutti were then the principal workers in modelled stucco in London, and were greatly employed by Gibbs, then the most successful pupil of Sir Christopher Wren, for whom they did some excellent work at Twickenham and at Cambridge, and who deemed them "the best" fretworkers in England. At Cambridge they were assisted by Denston, a Derbyshire plasterer, who afterwards did much work of this character throughout the Midlands. The true French character of this style will be found on the Plates XX. and XXI., illustrating the ceilings of

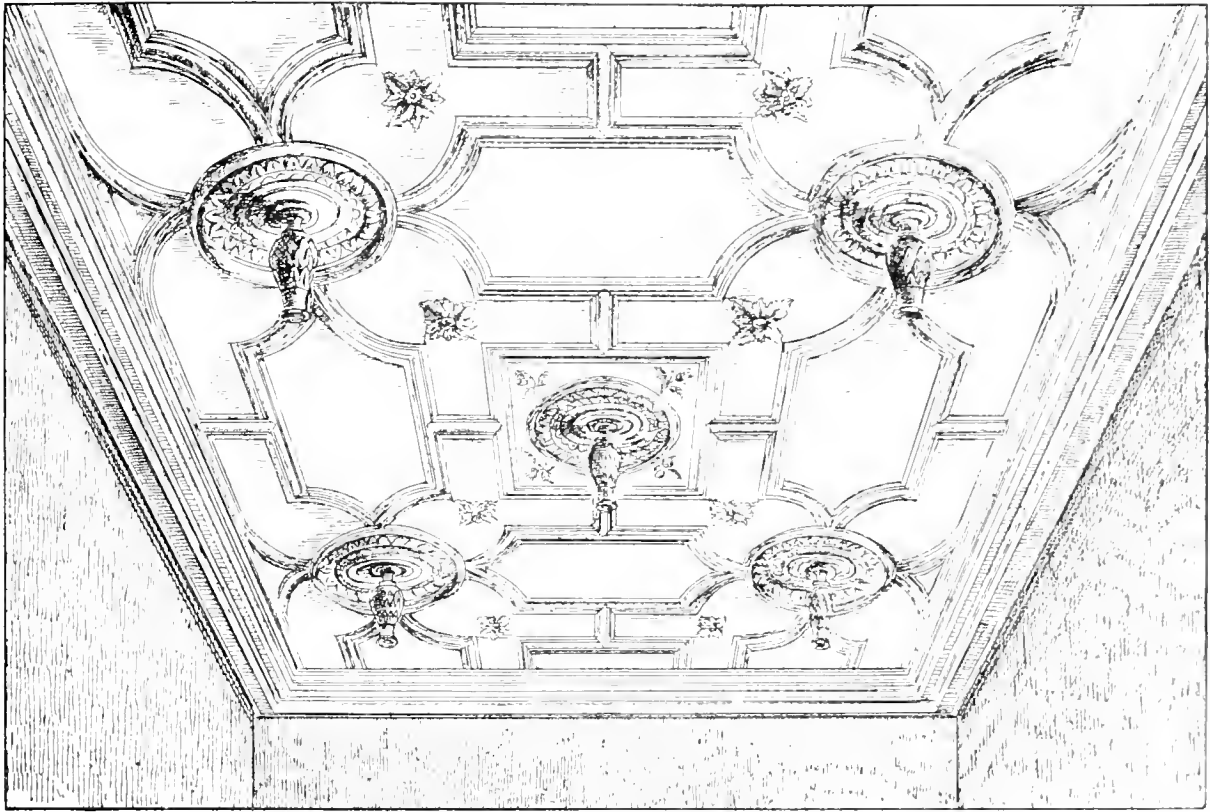

No. 10.—PLASTER CEILING, CARNOCK CASTLE, SHIRLINGSHERE, 1640.

the Queen's bed-chamber and the Salon de Medailles at Versailles, and a good example of the Italian translation of it in that of what is now the Queen of Italy's study at Turin Plate XXII.,. Naturally the Louis XV. style followed that of Louis XIV., a more flowing and less architectural distribution of ornament took place, and the plain field of the ceiling became a more important feature, the ornament being driven into the corners and in the centres, such as you will see in Plate XXIII., where is illustrated the ceiling of a room in Milton House in the Canongate at Edinburgh, and of which type many not long ago existed in London. A combined elevation and profile of the cornice of this ceiling are shown on Illustration No. 11. In such as these the trophies and medallions taken from the illustrations of such works as Fontaine's Fables, and other works of French origin, were frequently introduced in cast plaster, to the detriment of the plasterer's art, as the moulds were, like their subjects, imported also; nor were these the only cast portions, but the repetitive curves, "mutton chop bones," as they used to be called, were cast in sizes, and used to form the principal cartouches and leading lines, until their monotony called forth Ware's satire upon them, and Isaac Ware, who began his life as a chimney sweep, became a royal architect, and, as the arbiter of taste, published his "Complete Body of Architecture" in 1725. In this he says, "A ceiling straggled over with arched lines and O, C's and C's and tangled semicircles may please the light eye of the French, who seldom carry their observation further than a casual glance," and further tells us that "the French have furnished us with abundance of fanciful decorations for these purposes, little less barbarous than the Gothic"! Such an eminent dictum brought forth some English designs to amend this barbarity. So in 1773 Matthias Darley brought out his book

of designs in his "Complete Body of Architecture," but by this time so lost was the original plaster-work character and function that the same design was deemed equally applicable to painting or sculpture, and is often described as one "to be worked in stucco, carving, or paint." This was followed by Columbani's "New Book of Ornaments commonly worked in Stucco, Carving, or Painting"; and Chippendale, Pether, Lock, and even Batty Langley brought out books of designs for plasterers and carvers, setting a very reprehensible fashion, too much followed nowadays, by divorcing design from craft, and by no means improving either. The plasterer's art thus became thoughtless and absurd, having no specific character of its own, and the diletanti would have none of it. Simple purity became grateful to them because it was not ridiculous.

Hence came in those coffered ceilings, such as that at Sir Mark Pleydell's house at Coleshill, Berkshire (Plate XXIV.), in which there is a certain amount of nobility. What ornament there is, it is true is only cast work, but the coffers are deep, and give good play of light and shade, and are rigorously architectural, eloquent of the T-square and the drawing board, and redolent of precedents. These were premonitory of the death of the artistic plasterer. He borrowed, not made, his designs; he cast his ornaments, not modelled them; he kept a stock of moulds which he used more or less inappropriately, fitting his borrowed design to his ornament rather than designing his ornament to

fit an original one, and his work became dull, flat, stale, but by no means to him unprofitable. Curiously enough, the very ruins of old Rome, which two centuries before had given such an impetus to the plasterer's art, led to its extinction, for about the middle of the eighteenth century there was a decided feeling for the exhumation of the buried antiquities of Rome, and their study; and

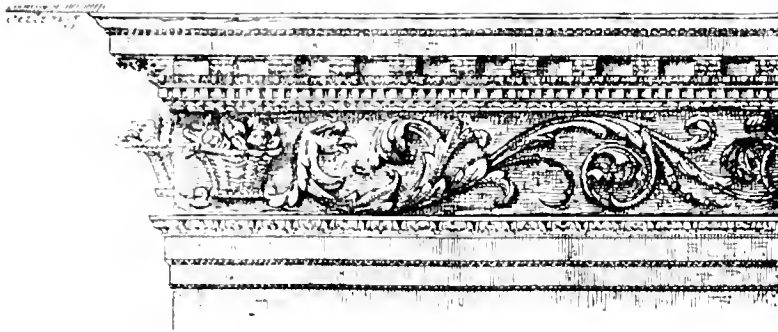

NO. II.—ELEVATION AND PROFILE OF CORNICE, MILTON HOUSE.

the publication of such works as Cameron's "Baths of the Romans," Ponce's "Bains de Titus," together with the host of works treating of Roman architecture, now had an enfeebling effect after the freedom and breadth of ornament they had created. Exceedingly pretty, they pleased the public taste; simple in their elements, they were easy to design; and full of work, they gratified their maker; and with here and there a cast cameo or a painting by Cipriani or Angelica Kauffmann, they were refined and delicate, such as you will find that from the Queen's room in Old Buckingham House (Plate XXV.); but very little work was left to the *art* of the plasterer. He chiefly cast the models another artist had made, for when his ornament became so monotonously repetitive there was no reason why he should model it separately. If you examine the ceilings from Kedleston (Plate XXVI.), Dublin (Plate XXVII.), or Pergolesi's design for a wall decoration (Plate XXVIII.), you will at once see how small amount of variety there is in the elements of their composition. Pergolesi was brought from Italy by Robert Adam as his decorative "ghost," and brought his "pastiglio," or paste composition, with him. And now it is no longer the plasterer who adorns the house—it is the "compo man"—again an Italian, so that the race and the place which caused the resurrection of plaster modelling caused also its death. Adam, indeed, "brought death into the world," so far as this fine old art and craft is concerned. And yet there were clever plasterers

assisting at its obsequies. Arturi, whose work we saw in St Martin's Church, lived till 1769. We had Naldini and Richter working here in 1770. Thomas and Charles Clark did some admirable work both in England and in Ireland from 1760 to 1780. Collins did much work for Sir William Chambers. Joseph Rose, who probably wrought on the Queen's room shown on Plate XXV., and was afterwards employed at Carlton House and Whitehall; and John Papworth, who died in 1799, and was almost the last of a fine old race of workers. Most of these plasterers were really artists, and their modelled medallions and individual bits of design are well worthy of study; but the vain repetition of "ornament" by the yard ruined them and the art expired, and perhaps the very last stucco modelling *in situ* done in London was on the ceiling of Hanover Chapel, Regent Street.

It may be thought I have in this short sketch of the long history of "Plaster Work, Plain and Decorative," dwelt too much on the higher development of it, but you must recollect that the higher development brings up the lower with it, and that all rise alike, so that in getting the best of one you get the best of both. Therefore, as time and space preclude the writing of an exhaustive history, I have only roughly outlined some of the prominent features of its interesting past. The principal object of this chapter is to show what great artists have aforesaid been the votaries of art in plaster work, and to induce those of our own day to try and revive the higher ambitions of the craftsmen of an art and craft which has such an important history, to raise it again to its former eminence, and to be no longer content with covering the sins of the "jerry-builder" with a charitable but very plain coat of indifferent plaster.

G. T. R.

CHAPTER I.

HISTORICAL PLASTERING IN ENGLAND, SCOTLAND, AND IRELAND.

PRIMITIVE. MEDIEVAL. ELIZABETHAN. JACOBÆAN—SEVENTEENTH AND EIGHTEENTH CENTURIES—NOTES ON OLD MATERIALS AND MANIPULATION—PLASTERERS' WAGES, HOURS, VICTUALS, AND DRINK DEFINED BY VARIOUS KINGS AND ACTS.

PRIMITIVE.—The primitive mode of plastering practised in Great Britain and Ireland, before lime plastering came into general use, was with clay, mud, or sticky and unctuous earth. The rudest forms of daubing or plastering were structures erected of wattles, and daubed over with mud to keep out the cold and wet. Domestic buildings erected in this manner were in general use in the time of Henry II. The Devonshire "cob," a class of building not yet extinct, is a fair sample of the ancient fashion of daubing or plastering practised in this country for many centuries. In the twelfth century, Nechan in his writings refers to "smoothing the surface of the walls by the trowel." According to Roger Hovenden, the English monarch in 1172 erected a royal residence with uncommon elegance. The London Assize of 1189 mentions "mud plasterers, turchers" *z. e.*, cob wallers); that of 1212 plasterers and whitewashers (*decalbatores*).

After the fire, in the year 1212, which destroyed London Bridge, and a number of houses, the bridge and the houses being made of wood, King John issued an ordinance in which the following items appear:—"All shops on the Thames be whitewashed and plastered within and without. All houses which till now are covered with reed or rush, which can be plastered, let them be plastered within eight days, and let those which shall not be plastered within that term be demolished by the alderman and lawful men of the venue. And let all houses in which brewing or baking is done, be plastered and whitewashed within and without, that they may be safe from fire." The same ordinance fixed the rate of wages for whitewashers and mud plasterers at 3d. per day with keep, or 4d. without keep. The mud plasterers were those who filled the spaces between the timber frames with mud, clay, and straw, which was afterwards whitewashed.

In the thirteenth and fourteenth centuries the plasterers proper and the daubers formed two distinct classes of workmen. The daubers were simply the layers on of a mixture of clay and mud to the timber framework. The dauber or inferior plasterer of the fourteenth century received 5d. per day from Easter to St Michael, and 4d. per day for the remainder of the

year if at work. The daubers' labourers who attended them, as well as the tylers, received 3½d. per day for one part of the year, and 3d. for the other part.

In the thirteenth century lime was sold by the bag and cwt. as at present. It was mixed with sand, and in some cases with pounded tiles. In 1282, for repairs of Newgate, the following items appear: "In the purchase of broken tiles, 2s. 4½d. In four score and four bags of lime, 7s. In twelve carts of sand, 2s." The pounded tiles in the mortar found in Medieval buildings may have led to the belief that they were of Roman origin. The architect has another item for repairs at Newgate at the same period, thus: "In plaster of Paris, bought to plaster the windows and the chamber where the Justices sit within, 13s. 4d. In wages of a plasterer and his servant, four days, 2s. 8d."

At the end of the twelfth and the beginning of the thirteenth century, the application of impressed plastic work for the purposes of architectural decoration was frequent. Delicate ornaments in low relief were impressed by means of wooden or metal tools on the moist plaster, which was afterwards painted and gilded.

MEDIAEVAL.—The Mediaevalists did good plaster work. The rubble walls and vaults of their churches were plastered and decorated. At Netley Abbey the vaults of rubble are covered with plaster the remains of which are still visible. At Little Braxted Church, Essex, an edifice in the Transitional style, a thin coating of fine plaster, ¼ inch thick, is found on the walls, showing good workmanship. Examples are still found at Eynsford in Kent, and at Oxford, where gable ends are covered with moulded plaster work, stamped diapers of geometrical design being slightly sunk on them. In Lancashire and Sussex half-timbered houses were plastered between the timbers with rough-cast made of lime, hay, coarse sand, and pebbles. An interesting discovery has lately been made in the Parish Church of Avebury, in Wilts. The outside of the walls of the nave above the aisle roof and around a circular window were found to be plastered, and on removing a portion of the thirteenth-century aisle wall, the plastering was found to be carried through but not bound into it; the connection of the walls around the quoins, which were found to be of the Saxon long and short work. This plaster had not been disturbed in adding the aisle wall in the thirteenth century.

There is an interesting agreement of the reign of Edward II. 1317 concerning the plastering of the Hall of John de Bretagne, Earl of Richmond. Thus runs the agreement of the master plasterer of the fourteenth century: "Know all men that I, Adam le plasterer, citizen of London, am held bound to Sir John de Bretagne, Earl of Richmond, to find plaster of Paris, at my own proper charges, good and sufficient, without default, proper, for the hall of the said Earl, and also that I will competently, at my own proper charges, plaster and complete the said hall, and will repair the walls of the same with the said plaster, well and befittingly within and without, as also the tewels (the louvres or flues) to the summit, in such manner as befits the repair of the hall aforesaid; and this I will do for 24 pounds sterling, which my lord the said Earl has paid to me beforehand. Faithfully to perform the which work within eight weeks from the day of the Holy Trinity next ensuing, I do bind myself and all my goods movable and immovable, namely my lands, houses, and tenements, within the city of London being, to distress in part of any bailiff of our lord the King," &c.

In London in the time of Edward III. 1350, the plasterers were bound to take no more for their working day between the feasts of Easter and St Michael than 6d. per day without victuals or drink, and 5d. per day for the remainder of the year. Upon feast days when they did not work they received no wages.

A further mention of the plasterer or dauber is found in an account of moneys expended for the repair of a house in the parish of St Michael's, Cornhill, in the reign of Edward III. (1359), viz.: "For 12 cartloads of lom-loam, 4s.; for 9 sacks of lime, 18d.; for 3 cartloads of sand, 12d.; for one workman's wages for daubing, 9 days at 7d. per day, 5s. 3d.; for his man the same time at 5d. per day, 3s. 6d."

Again, in an account of expenses incurred by the representatives of the City attending the Parliament in 13 Richard II. (1389), the plasterers or daubers put in an appearance: "For timber and carpentry, tilers and daubers, in preparing the house for their lodgings, as well as the chambers as the hall, buttery, kitchen, and stables for horses; and for making *stoles* and *fourmes*—stools and forms—throughout, and for carting out the rubbish, such house being quite ruinous; as also for payment made to the goodman of the house for said lodging, £6. 9s."

An example of old plaster work, as treated for external work, is to be seen in an ancient house at Clare, in Suffolk (Plate VI.). This fine old half-timbered house, according to the date in the front, was built in 1473. Its most remarkable feature is the quaint treatment of the plaster work, which is in high relief, some of the enrichments rising 2 inches from the ground surface. Beneath the oriel bay on the first floor are two small figures supporting a shield charged with the arms of Verdun. Beneath a window at the side of the house is a winged animal. The scroll work on this level, also that above and around the oriel bay, appears to be all hand work.

The following reference to external stucco work is taken from the "Vulgaria" of Hormann, dated 1519, the text of which is in Latin: "Some men will have their walls plastered, some pargetted and whytlymed, some rough caste, some pricked, some wrought with playster of Paris."

At Newark there is a fine example of exterior decorative plaster work on the front of a house in the Market Place, which was built in the fifteenth century. The most prominent feature is a series of niches and plaster figures.

During the reign of Henry VIII., the pupil of Wolsey, and the rival of Francis, many Italian stucco workers found their way into this country. Nor was there any country in Western Europe more fitted to receive their work than was ours. The half-timbered framework houses, with their large surface of plastered panels, seemed purposely prepared for raised plaster work, and what we call pargetry at once established its footing. Heraldic achievements, foliage, and figure work appeared in abundance, and our ceilings were adorned with moulded compartments, filled with devices and quaint rebuses, and hung with flowered pendants, all modelled by hand; and above all rose Nonsuch Palace, of which unfortunately no relic and limited records remain. Nonsuch was begun about 1527, and although the embellishment of this sumptuous palace was the hobby of the last ten years of King Henry's life, it was not finished at his death. Its completion was due to the Earl of Arundel, in Queen Mary's days, to whom English art owes so much. Built according to the custom of the country, of timber framing, it was well suited for the display of the then newest fashion in decorative art. Nonsuch Palace obtained a great reputation for luxury and magnificence, and was frequently visited and mentioned by many celebrities. Leland says of it:

"Hanc quia non habent similem laudare Britanni
 Sape solent nullique parem cognomine dicunt."
 ("Unrivalled in design, the Britons tell
 The wondrous praises of this nonpareil.")

Queen Elizabeth was a frequent guest there. Hertzner, a German traveller, who visited the palace in Elizabeth's time, says that it was built "with an excess of magnificence and elegance, even to

ostentation. One would imagine everything that architecture can perform to have been employed on this one work. There are everywhere so many statues that seem to breathe, so many miracles of consummate art, so many casts that rival even the perfection of Roman antiquity, that it may well claim and justify its name of Nonsuch, being without an equal, or, as the poet sings :—

‘This which no equal has in art or fame,
Britons deservedly do Nonsuch name.’

The Duke of Saxe-Weimar, who visited Nonsuch in 1613, tells us that the labours of Hercules were set forth on the king's side, the queen's side exhibiting all kinds of heathen stories, with naked female figures. Pepys, who visited it in 1665, describes all the house on the outside filled with figures. Changing hands frequently, despoiled as a royal residence during the Parliamentary wars, Nonsuch fell into decay. Evelyn saw it when neglect and vandalism had brought it well-nigh to ruin, and yet he was filled with admiration with what remained. “I took,” he says, “an exact view of the plaster statues and *bas-reliefs* inserted between the timbers and puncheons of the outside walls of the court. I much admired how it had lasted so well and entire from the time of Henry VIII., exposed as they are to the air, and pity it is they are not taken out and placed in some dry place—a gallery would much become them. They are *mezzo-reliefs* the size of life. The story is of heathen gods, emblems, and compartments.”

The last mention of this palace occurs in James II.'s time, when P. le Neve, in his copy of Aubrey's Surrey, says he then saw it, and that it was “done with plaster work made of rye dough very costly.” It is very probable that rye meal was mixed with the plaster, as the gluten would retard the setting, and the admixture work freely, and eventually become hard. This magnificent palace of plastic art, which introduced decorative modelled stucco work into England, may be justly termed the “plasterer's pride and pleasure.”

The amount of royal patronage exalted the plasterers' craft mightily, and from this time downwards until the end of the last century the plasterer was one of the most fertile of our art workmen, and one of the best paid. In Edward VI.'s time (1547-53) his wages were 11d. per day, painters and carpenters only earning 6d. and 7d. per day, showing the superior estimation in which the plasterer was held. In fact, during the latter part of the sixteenth century, and throughout the seventeenth century, there was scarcely a house of any import in the country which had not its rooms adorned with modelled plaster work—not merely the ceilings, but frequently the wall space between the high wainscot dado and the cornice was so decorated, whilst over the mantel-piece was often some large allegory or heraldic achievement wrought in stucco; and what is particularly interesting is, that in spite of all the Italian teachers who inaugurated the art, the English plasterer never became that “Diavolo incarnato, Inglese Italianato,” but retained a national art speech—somewhat rough at times, it may be, but always purely vernacular.

In 1501 a charter was granted to the plasterers' craft by Henry VII., and the arms of the Plasterers' Company were granted by Henry VIII. in 1546. The following extract from the charter, if put into force in the present age, would render the existence of the jerry worker and scamped work impossible: “The right to search and try and make, and exercise due search as well in, upon, and of all manner of stuff touching and concerning the art and mystery of pargettors, commonly called plaisterers, and upon all work and workmen in the said art or mystery, so that the said work might be just, true, and lawful, without any deceit or fraud whatsoever, within the city of London or suburbs thereof.” In those days the different parts of a building were carried out by master craftsmen. This fact is borne out by the charter granted by Charles II., which forbade any

person from carrying on simultaneously the trades of a mason, bricklayer, and plasterer, and also forbade any person to exercise or carry on the art of a plasterer without having been apprenticed seven years. Search days, as described in the charter, were annually appointed up to 1832, and fines were inflicted upon offenders for using bad materials and bad workmanship.

At Bolling Hall, Yorkshire, one of the plaster ceilings is said to be fully four hundred years old, and is considered to be one of the most remarkable specimens of the work of the period. The ornamentation, which is in high relief, is most quaint, its principal characteristics being heads of dogs, bears, and foxes, from the open mouths of which issue branches of various fruit trees, different kinds of birds and animals being inserted here and there. The cornice is of considerable depth, quaintly enriched with heads and fabulous animals. The drawing-room ceiling, which is of later construction, is interesting for its free and fine treatment. At Nettlecombe, the seat of the Trevelyans, built in the fifteenth century, the great hall has an elaborate ceiling. The manor-house at Quantockshead, Somersetshire, built in the sixteenth century, is decorated with rich plaster friezes and ceilings. The quaint example of external plaster work on the exterior walls of a cottage at Wyvenhoe, near Colchester, was probably executed in the first part of the sixteenth century. A part of this work is illustrated in Chapter I. This is taken from "Architecture of the Renaissance in England," by J. A. Gotch, F.R.I.B.A.

Some curious entries are contained in the register of St Benet's Church, Gracechurch Street, London, one of Sir Christopher Wren's buildings re-erected after the Great Fire. Thus at the accession of Queen Mary in 1553: "Paid to a plasterer for washing owte, and defacing of such Scriptures as in ye tyme of King Edward VI. were written aboute the Church and walls, we be commaunded to do so by ye Right Honor. ye Lord bishopp of Winchester, Ld. Chanr. of England, 3s. 4d."

The Duke of Wurtemberg, the "Cosen Garmobles" and "Duke de Jamaree" of Shakespeare, who visited England in 1592, was ravished with the plaster ceilings at Theobald's, &c. Once the interior plaster work glowed with gold and colour.

Shakespeare, that mighty master of man's mind and manners, mentions the plasterer, and various kinds of plastic materials used in the seventeenth and preceding centuries. In "Henry VI.," Stafford says to Jack Cade, "Thy father was a plasterer." In "A Midsummer Night's Dream," Bottom says, "And let him have some plaster, or some loam, or some rough-cast"; and again, "Would you desire lime and hair to speak better?"

An old system of plastering, known as pargetting, was once very general. The word "pargetting," although now seldom used except by bricklayers for the coarse plastering inside chimney flues, formerly signified plaster work decorated by means of stamps, the soft plaster being stamped or pressed to form repeated designs. Sometimes a happy combination of stamped and hand work was used for both exterior and interior plaster work. This work is sometimes called "parget work." The Elizabethan half-timbered houses exhibited on their exteriors ornamental pargetting, displaying small figures and canopies surmounting them executed in plaster work. Many specimens of old plaster work are found to contain rye-straw, to give it tenacity. Another kind has been discovered mixed with fibre and reeds, which was commonly used in the sixteenth century.

Pargetting is mentioned in the "Hist. Dunelm." (1450), as follows: "Johanni Bevis, pro pargetting and blanchyng, Vs." "Blanchyng" probably means cleaning or whitewashing. Bishop King's House at Oxford is a well-preserved example of figure and pargetted work. Also at Banbury, Oxfordshire, there is an ancient example of parget plaster work. The ancient house at Clare, previously mentioned, is a combination of pargetting and hand work. Other examples are to be

seen at Parham Hall, Lavenham, Suffolk. In the "Survey of the Manors of Wimbleton" (A.D. 1649) is an entry which reads: "Above which (waynscot is a border of fret or parge work wrought, having therein set eleven pictures of very good workmanship; the seiling (ceiling is of the same fret or parge work."

ELIZABETHAN.—In the Elizabethan and subsequent periods plaster work was used largely in ceiling, wall, and chimney decoration. During the reigns of Elizabeth and James I. a transitional style between Gothic and Classic was developed. This style was employed in some of the most stately houses in the United Kingdom. There arose such mansions as Hatfield, Longleat, Burley, Audley End, Crewe, Littlecoats, Wilts, Chatsworth, Haddon, Hardwick, Blickling Hall, Bramshill House, Ruston Hall, and many others, wherein may be found rich and rare examples of plaster work, showing great excellence in design and workmanship. The ceilings are usually divided by intricate geometrically formed panelling, ornamented with foliage, heads, animals, swags, ribbons, shields, pendants, drapery, bands, and many other devices.

Sir Paul Pindar's House, London, built in the reign of Queen Elizabeth, contains some glorious old plaster ceilings. These ceilings abound in the richest and finest devices. Wreaths of flowers, panels, shields, pateræ, bands, roses, ribands, and other forms of ornamentation are charmingly mingled, and unite in producing the best and happiest effect. One of them, which is all but perfect, consists of a large device in the centre representing the sacrifice of Isaac, from which a most exquisite design radiates to the very extremities of the room. In general, however, the work consists of various figures placed within multangular compartments of different sizes, that in the centre of the room usually the largest. The projecting ribs, which in their turn enclose the compartments, are themselves furnished with plentiful ornamentation, consisting of bands of oak leaves and other vegetable forms, and in several instances have fine pendants at the points of intersection. The cornices consist of a rich series of highly ornamental mouldings. Every part, however, is in strict keeping, and none of the details surfeit the taste or weary the eye (Cassell's "Old London").

Losely House, near Guildford, the seat of Sir James More Molyneux, erected 1562, contains some good plaster ceilings. Plate VII. shows a portion of one of the bedroom ceilings. The pattern is about 5 feet square before being repeated, and the panels are enriched with the moorcock and moorhen, badges of the More family. The mouldings are about 8 inches deep, and the pendants 2 feet. This is in great contrast to our modern bare whitewashed bedroom ceilings.

A fine example of external plaster work is the "Ancient House" at Ipswich, erected in 1567 (Plate XVIII.). Although built in Elizabeth's reign, its chief glory is Jacobean. The royal arms, with CIIR. in the centre, form a conspicuous feature, while a surrounding of birds, fishes, and musical instruments, together with figures representing the continents, enriched by swags of flowers and fruit, completes the harmony of the composition. In another part Atlas supports the world. St George vanquishing the Dragon is boldly depicted on one of the gables, and Phillida and Corydon adorn another side. A finely modelled triumphal procession enriches the side of another gable. The whole is probably hand wrought *in situ*. The Old Assembly Room in the same town has likewise some fine examples of hand-wrought plaster work. Mr G. Bedingfield, of Ipswich, who has repaired portions of both the above, says that the stucco is still of an extremely hard nature, although it has been exposed to our variable climate for over three centuries.

Great Yarmouth is rich in fine and well-preserved examples of decorative plaster work, which were executed in the Elizabethan and Jacobean periods. There is a similarity of design in some of the ceilings, especially as regards the loops at the intersection of panels. The Star Hotel, which was

built in the reign of Queen Elizabeth, contains several decorative ceilings. The most notable is the Nelson Room ceiling, which is divided by flat enriched bands into six flat arched bays, which are adorned with ribbed mouldings, foliage, and pendants. The Quay is the centre of most pleasing plaster work. On the south side of the Row fronting the Quay is an old house, now divided into two residences Nos. 46 and 47, which was probably built in 1580. One of the ceilings is adorned with mouldings divided into compartments, in which are various devices. One represents Noah's Ark, with the dove returning with an olive branch. Another is the figure of Neptune bestriding a sea-horse. The beam running across the ceiling is enriched with fleur-de-lis, and numerous masks of the human face adorn the sides. The fine old "Ancient House," No. 4 South Quay, was built about 1596. A portion of the drawing-room ceiling is shown in Plate VIII. This room is 30 feet by 20 feet. A peculiar feature in this, as well as in the others, is the interwoven mouldings, which form knots and loops at the intersections. This ceiling is divided into fifteen separate compartments. In an old house at the south-west corner of South Quay there is a very rich and elegant pendant ceiling (Plate IX.), exhibiting in the centre compartment the arms of James I. It will be observed that a mistake has been made in rendering the motto at the foot of the royal arms. It should be the beginning of Psalm lxxviii. ("Exurgat Deus dissipentur inimici"). The pendants at the intersections of the ribs are singular, each having on one side an angel with extended wings. In an upper chamber there is a very rich ceiling, profusely adorned with fruit and flowers. There is another curious ceiling (Plate X.) in a house in the same Quay. It appears from the design to be coeval with No. 4 South Quay. The design is somewhat similar, especially at the looped mouldings and the manipulation of the enrichments.

JACOBEAN.—At the beginning of the seventeenth century the plasterers apparently had taken so much upon themselves that an Act was passed, in the first year of King James, forbidding plasterers to do any painting within the city of London or in its suburbs, and restricting them to the use of some few distemper colours only. The painters did not gain much by this, for gradually painted work declined, whilst modelled work still continued in the ascendant; but during the troublesome times of the Commonwealth it fell into disuse. With the Restoration came in the flowing rococo ornaments of French and Italian character.

A well-known writer states that "during the end of the sixteenth century, and throughout the seventeenth, there was scarcely a mansion in England and Scotland which did not exemplify the plasterers' craft outside or in, and often both."

In 1547, a Charles Williams, as already mentioned, is described as being an English stucco worker of renown. He was employed by Sir John Thynne in the decorations of the new house at Longleat. His fame as a stucco worker evidently spread, for Sir William Cavendish and "Bess of Hardwick," his wife, being at that time busy at Hardwick, wrote to Sir John requesting the use of this "cunning playsterer," who they hear had made "dyvers pendants and other pretty things, and flowered the Hall at Longleat," to do like work for them at Hardwick. Probably the frieze still to be seen on the ruined wall of an upper room in the old house is his work. It was more in the curious and cunning distribution of formative panelling than in figure modelling that the Englishman distinguished himself. Our native craftsmen seem to have developed a ceiling treatment for themselves, in no way founded on Italian tradition or practice. Using the arrangement of the fan-tracery of the Late Perpendicular Gothic as a model, they founded an entirely new treatment of ribs and pendentives, often of most intricate geometric arrangement.

Bramshill House, Hampshire, the seat of Sir John Cope, Bart., dates from 1603. The drawing-room ceiling, a portion of which is depicted on Plate XI., is a fine example of the Elizabethan

period. An uncommon feature is the introduction of narrow ribs, which are interlaced through the larger ribs, forming a separate design, yet harmonising well with the others.

There is some quaint old plaster work in Chester, notably on the exterior of Bishop Lloyd's House. Some of the panels represent various subjects from the Old Testament, also the arms of James I.

Audley End, Essex, built about 1610, contains some of the most exquisite examples of plaster work in England. The portion of one of the ceilings shown in Plate XII. is remarkable for its most beautiful, quaint, intricate, and ingenious design. No part of the figure is repeated, and no two curves are alike. The figure, as marked, is 20 feet by 12 feet before being repeated.

The hall ceiling (Plate XIV., of Craigievar, Aberdeenshire 1611,) is a rare example of arched work. A finely designed ribbed pendentive depends from the centre of the vault, while two smaller ones depend from the centres of the halves of the ceiling. The panels are enriched with coats of arms, foliage, &c. The general design is somewhat similar to the ceiling in Moray House.

Moray House, Canongate, Edinburgh, built in 1618, has rare examples of plaster ceilings. The one shown in Plate XV. is an excellent example of vaulted work. It is beautifully panelled and enriched. The main panels terminate with bold pendants.

There are some fine examples of stucco work at Hardwick Hall, Derbyshire. They consist of fine ceiling and hand-modelled stucco work on the chimney-pieces, and in the great gallery there is a fine frieze 11 feet in depth, all modelled *in situ*. It represents hunting subjects full of men, animals, trees, plants, &c. When Bess of Hardwick built the new house between the years 1590 and 1597, she left the old one to decay; yet there is in one of the rooms of that old roofless house a frieze similar in design to that in the new one, which has stood exposure for many generations without showing any signs of decay, good evidence of the durability of stucco. There is some modelled stucco at Haddon Hall. Over one of the chimney-pieces is a quaint representation of Orpheus in hand-wrought stucco.

Corsham Court, Chippenham, built in the seventeenth century, contains some fine examples of stucco work done in the Elizabethan style. In one room there is a curious cornice, consisting of one hundred and sixty heads in *basso-relievo*, and all different.

In the Cotswolds there are some examples of what, in a sense, may be classed as constructional plaster work, and termed "wattle and daub." This is a rough framework of timber, covered with interlaced wicker work plastered on the outside face. The floors are pugged with lime and chopped straw. In the same district there are some stone buildings erected in the seventeenth century. They are plastered in an original way by leaving the dressed stone work exposed.

There is a curious old plaster ceiling in the staircase at Quidenham Park, Norfolk. This ceiling is remarkable for its fine foliations, and having in the centre a ship pendant, dated 1619.

Illustrations Nos. 7, 8, and 9 show portions of plaster ceilings of geometrical design in old houses in Lime Street, London, which were built about 1620, and were recently dismantled for street improvements. No. 8 shows elevation of the cornice and section of the ceiling through A B. Chimney-pieces and wood cornices from the same houses are now exhibited in South Kensington Museum.

Winton House, Haddington, built in 1620, is situated near Edinburgh. It was designed and built by William Wallace for the Earl of Winton. Wallace was appointed master-mason to the King in 1617, and a burghess of Edinburgh in 1621. The portion of the drawing-room ceiling (Plate XVI.) is remarkable for its great variety of well-modelled panel ornaments, which include coats of arms, crowns, monograms, figures, cherubs, and many other devices, and foliage. A

peculiar feature in the geometrical design is the different divisions of the four oblong panels at the sides of the square panels, being alternately divided by circular and straight ribs. The figure is repeated six times in the length of the room, the whole forming a beautifully decorated ceiling. This room is about 45 feet by 26 feet.

The ceiling of the State bed-chamber at Boston Manor House, near Brentford, built in 1623, portrayed in Plate XIII., is peculiarly characteristic of the Elizabethan style. There is another ceiling, larger and more elaborate than the one here given, in the same house. The principal figures which adorn the panels of this ceiling are personifications of the five Senses; the four Elements; the three Christian graces, Faith, Hope, and Charity; War and Peace; Peace again, and Plenty. In one of the panels the date 1623 appears, and in a corresponding panel are the initials M. R. The extraordinary number of panelled ceilings and cornices with enriched friezes in old houses of the date of Elizabeth, James I., and Charles I. and II., are remarkable for their fine plaster work. The plaster friezes are adorned with shields, festoons, foliage, and figures of the human form; also with simple designs of strap work, with foliage and fruit.

SEVENTEENTH AND EIGHTEENTH CENTURIES. — Holyrood Palace, Edinburgh, was erected by James IV. in 1525, but the portion forming the quadrangle was only built during the reigns of Charles I. and II. Holyrood Palace contains many fine old plaster ceilings, some of which were done by French plasterers brought over by James I. It was during the reign of Charles II., about 1671, that the staircase ceiling (Plate XVII.) and some others in the Palace finer than this were done by Italian plasterers, or artists, as they then were entitled to wear ruffled shirts, lace, and to carry swords)—gentlemen of the "Minor Arti," as the Italians name them—and who travelled as the carver masons did, from job to job. The ceilings in Holyrood done by these gentlemen plasterers were modelled *in situ* while the plaster was still soft. Probably they used size water or some such material to prevent the plaster setting too quickly. The plaster was evidently gauged with lime putty, also mixed with hair, a greater portion of putty and hair being used for the lower stratum, and decreasing as the work proceeded to the finished surface. The work is obviously modelled *in situ*. It has a relief and variety of detail such as could only be got by hand. Tool traces and the workers' names are visible in parts, and the work is still without a sign of flaw or crack. There are two quaint old buildings to be seen at Saffron Walden, Essex. They are interesting examples of old external plaster work. There is no definite and reliable information to be obtained as to their early history. On one of the gables is the date 1676. On another gable are to be found some crude but curious figures standing in bold relief in the plaster work, one armed with a spear and the other with a club. The walls are also decorated with rough quaint plaster work. There is a striking resemblance in the architecture to the ancient house in Clare, Suffolk. Plate XIX.* depicts a portion of the plaster ceiling and walls taken from the gallery in St Martin's-in-the-Fields, Trafalgar Square, London. This beautiful church was built in 1722, and designed by James Gibbs, a celebrated architect, born at Aberdeen in 1674. The internal effect is very fine from its spaciousness, stateliness, and ornamental treatment. It is divided into nave and aisles by a range of four Corinthian columns, and two pilasters on each side. Each column supports a block entablature, and from this springs a semi-elliptical ceiling over the nave. The vault is pierced transversely above the columns by semicircular arches springing from column to column. At the back of the

* This plate, from a photograph taken for "London Churches of the Seventeenth and Eighteenth Centuries," edited by G. H. Birch, F.S.A., is reproduced by permission of the publisher, Mr B. T. Batsford.

block entablatures, semicircular arches are carried over the aisles, and received on consoles on the outer walls, and, by the intersection of these, pendentives are formed, carrying small shallow domes over the galleries. The nave terminates eastwards in two quadrants of circles on each side, and beyond is the altar recess, which has a semi-elliptical vault parallel to the nave vault. The ceiling is richly panelled, and decorated with raised plaster work, consisting of panel mouldings, relieved with a guilloche of simple yet bold design, and panels with centre flowers, *patere*, angle pieces, and other foliage surrounding clouds and cupids. The royal arms of the Stuarts, in accordance with the then prevailing fashion, adorn one of the panels at the end of the ceiling near the altar. The block entablature enrichments and the column capitals are finely modelled. This effective plaster work was executed by G. Arturi and A. Baggutti, who also did the plaster work at St Mary's-le-Strand and many other works in plaster for James Gibbs.

The ceiling depicted in Plate XXIII. shows a little over one quarter of a ceiling in Milton House, Edinburgh. This ceiling is in the style of Louis XV., and was executed by French plasterers. In 1845 my father did some repairs to this ceiling, and judging from the tool marks on the work, and the general absence of precision of balance in depth and distance of the rights and lefts of the ornament, which is always, or nearly so, found in cast work, he was of opinion that all the ornament was worked *in situ* by hand. Illustration No. 11 shows the elevation with profile of the cornice. Milton House was erected about 1725 for Andrew Fletcher, a son of "Fletcher of Salton." The house has recently been demolished, and a Board School erected on the site. The example of a plaster ceiling in the classic style is depicted in Plate XXIV. This shows a portion of the plan (a little over one-half) of the dining-room ceiling at Sir Mark Pleydell's Mansion, Coleshill, Berkshire, erected about 1750, and designed by Inigo Jones. An elevation of the cornice is shown at the bottom of the Plate; this also shows section of the cornice and ceiling panel mouldings.

The plan, with elevation and section, of the ceiling depicted on Plate XXV., is one in the Queen's room in old Buckingham House the site of Buckingham Palace. This beautiful ceiling was designed by Robert Adam about 1760, the enrichments being modelled by Rose. Adam created a style which still bears his name. The style affords but scant scope for the modeller's talent. The enrichments are mostly a series of small repeated parts, consisting generally of wreaths, or swags of husks, beads, festoons of leaves in ribbons, relieved at intervals with Etruscan vases. Many of the designs have cartouches with figures in low relief, or with paintings by artists of note, such as Kauffmann, Cipriani, and Zucchi. The style as a whole is chaste and graceful. Robert Adam was born in 1728 at Kirkcaldy, in Fifeshire.

The brothers Adam (Robert and James) are credited with introducing the plan of building several houses together, so as to represent when completed one building of imposing appearance and dimensions. The introduction of the steel fire-grate, and the practice of plastering the exteriors of brick houses, and composition enrichments for wood, iron, and plaster work, is also attributed to them. Robert died in 1792, and was honoured with a tomb in Westminster Abbey. I have given these details partly because the brothers Adam introduced into England stucco façades and composition enrichments, and partly because of the recent revival of their style which caused a great amount of inquiries and comment in the trade.

An excellent example of Sir Christopher Wren's decorative plaster work is to be seen in the office of the New River Company.

In 1750, Denstone, of Derbyshire, did some fine hand-wrought plaster work at Cambridge.

An interesting example of a plaster ceiling in the antique style is depicted in Plate XXVI.

This shows a portion of the ceiling in the Grecian Hall at Kedleston, Derbyshire, executed for Lord Scarsdale about 1770. The hall is 60 feet 6 inches by 30 feet 6 inches. The cornice is omitted from this illustration. The ceiling is partly coved, as indicated by the open spaces at the angles, which converge to the straight portion of the ceiling. The two oblong panels, with the oval enrichments at the straight part of the ceiling, as shown in the illustration, are repeated twice and a half to complete the length of the ceiling. This handsome ceiling was designed by G. Richardson, and the Grecian trophies and the other ornaments were executed by Rose.

The dressing-room ceiling (Plate XXVII.) in Lord Montalt's mansion, Dublin, was executed about 1770. The room is 24 feet long and 20 feet wide. The bas-relief in the centre panel, representing Hercules and Omphale, was executed by E. Robbins, and the other ornaments were modelled by A. Collins. This elegant and chaste ceiling was designed by G. Richardson.

From 1750 to 1780 A. Wilton did some fine plaster work at Cambridge, and in many mansions in London and vicinity. Wilton was the father of Wilton the sculptor, who originally was brought up to his father's business, but after spending many years in Rome he returned to London, and was one of the founders of the Royal Academy.

In 1783 Thomas and Charles Clark, two Irishmen, were employed by Sir William Chambers on the fine plaster work at Somerset House. About the same time they also did some good work in Dublin. W. Collins, who died about 1793, was also employed by Sir William Chambers at Somerset House.

John Papworth, an eminent stuccoist of London, who died in 1799, did the decorative plaster work in the great Royal Academy Room at Somerset House, and, with his eldest son, also at the rebuilding of the chapel of Greenwich Hospital, under James Stuart, the Athenian. The whole of the work was done by hand *in situ*. There is a curious anecdote concerning this building. Young Papworth, some years afterwards, was showing the place to a party of friends, and one of the guides informed them that the plasterer who did the ceiling, when lying on his back on the scaffolding, tumbled off and was killed. Great was the astonishment of the guide when Papworth said he was the workman. Papworth was the father of a long race of architects and writers on art.

The examples of decorative plaster work mentioned in this chapter are some which I have personally seen or which have been brought to my notice on account of their rarity or exceptional artistic features. My readers will be aware that a great many further fine examples are to be found within the United Kingdom.

The names of other modellers and plasterers are given in other parts of this work, not only as a tribute to their worth as men who gloried in their works, but also to encourage the rising generation of plasterers to endeavour to get their names inscribed in the plasterers' niche of Fame.

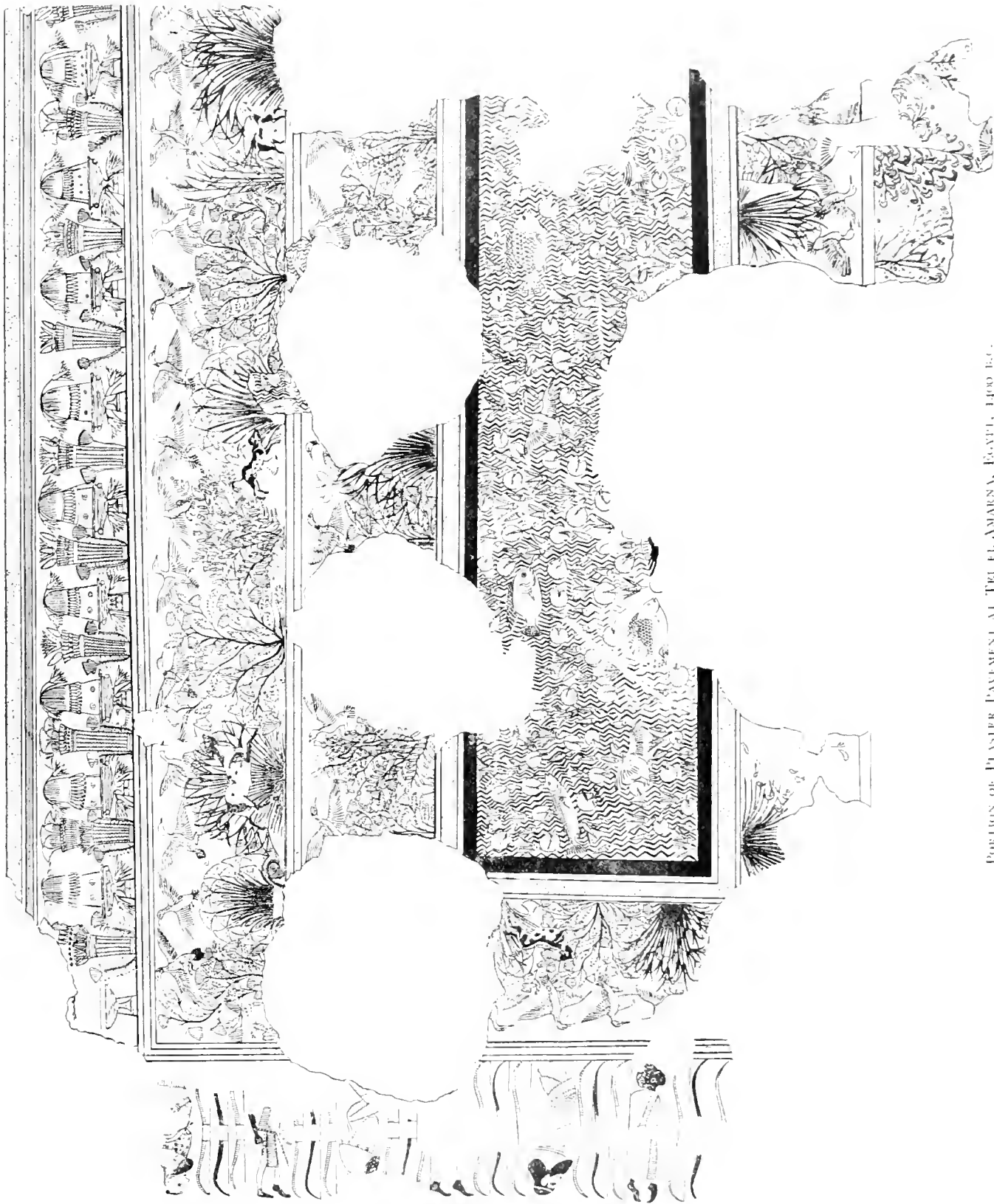

PORTION OF PLASTER PAVEMENT AT TEL EL-AMARNA, EGYPT, 1400 B.C.

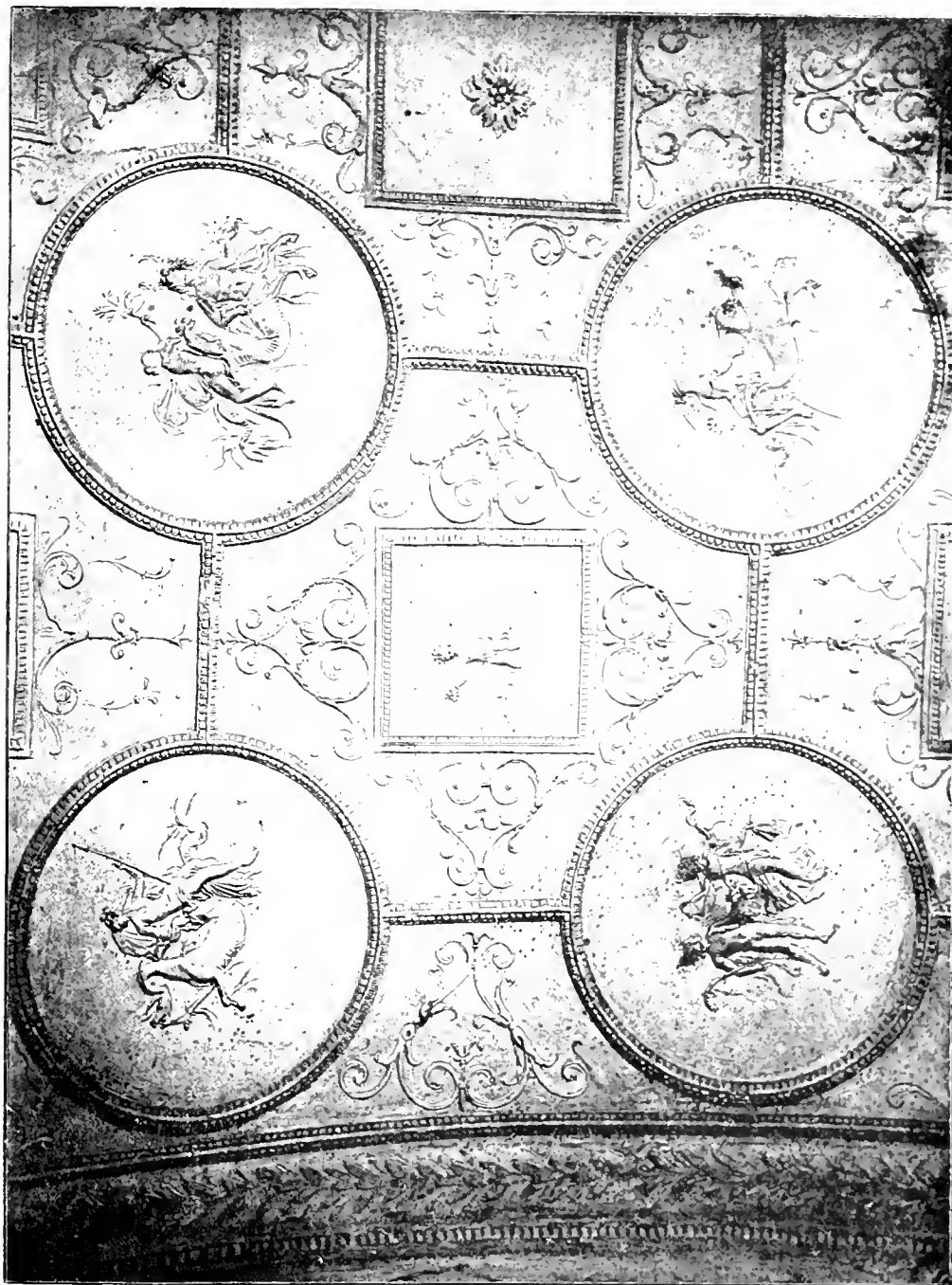

PORTION OF STUCCO CEILING IN LOW RELIEF, IN A TOMB, VIA LATINA, ROME, FIRST CENTURY.



STUCCO CEILING AND WALL DECORATION, PALAZZO D'ADRIANO, VENICE. (A. V. 11. 15)

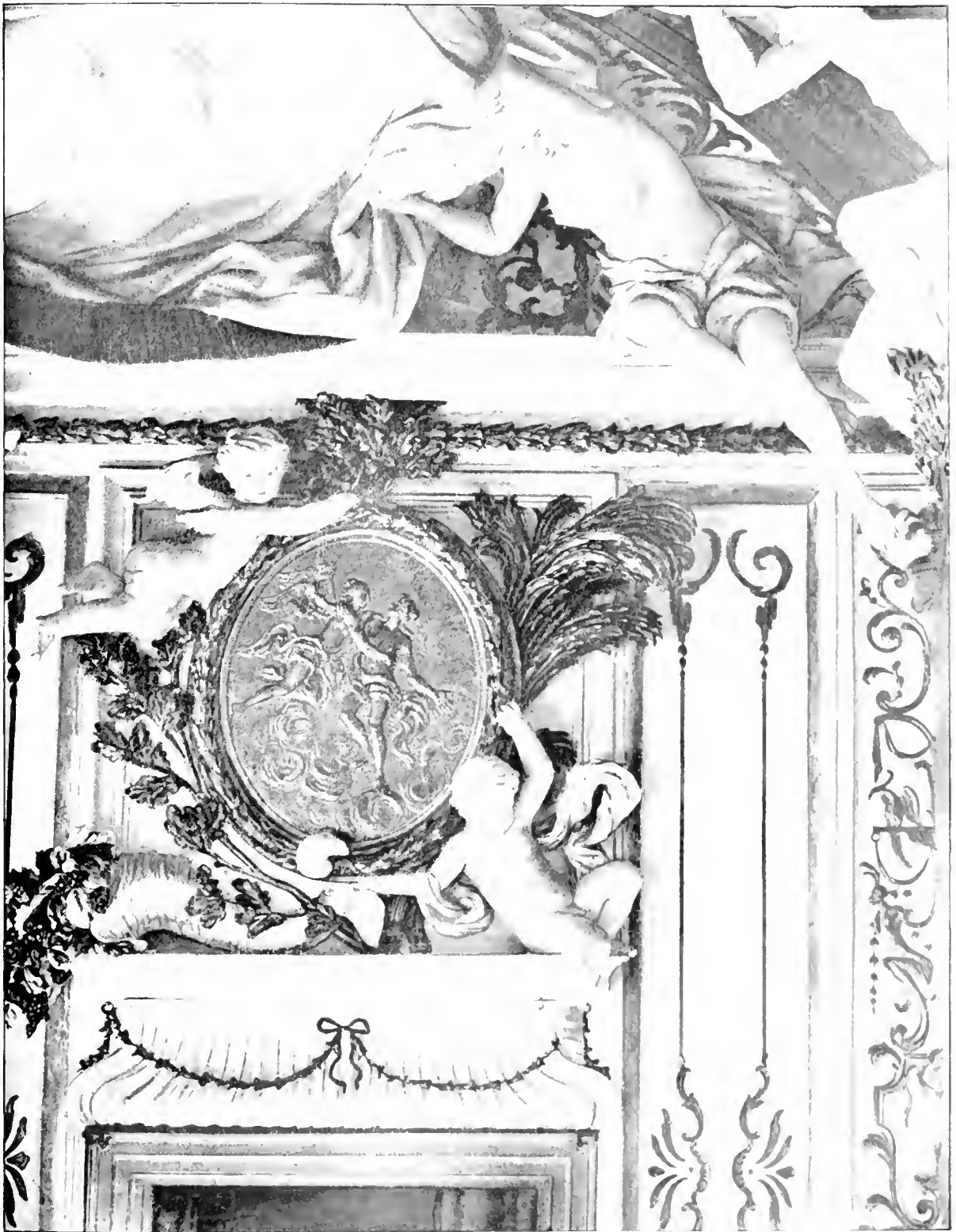

STUCCO CEILING, OVER DOOR, AND WALL OF SALON, PALACE DE LA VILLE, PARIS. (A. V. 1874, FIG. 15)

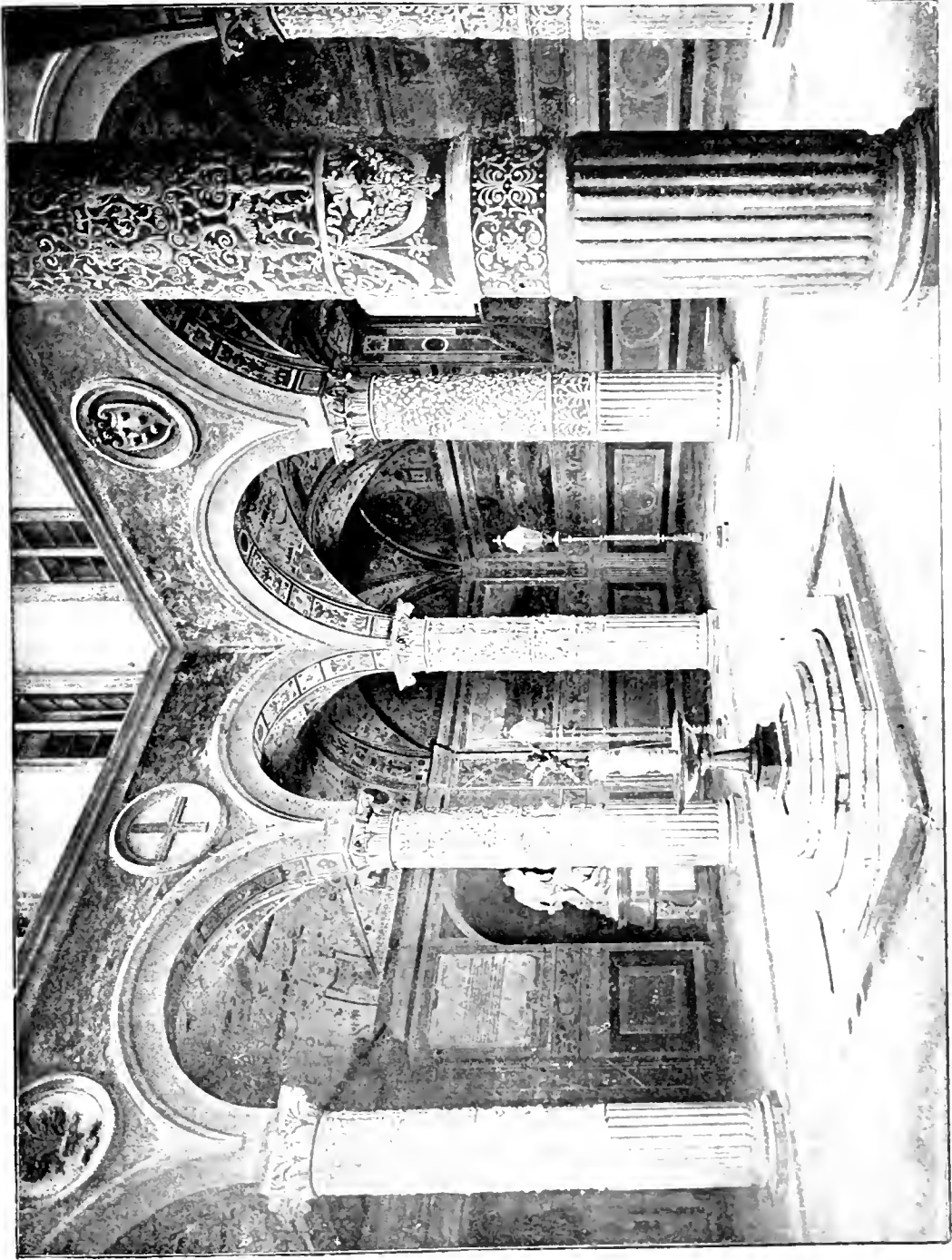

SILICO PILARS, COURTYARD OF THE PALAZZO VECCHIO, FLORENCE, 1566.

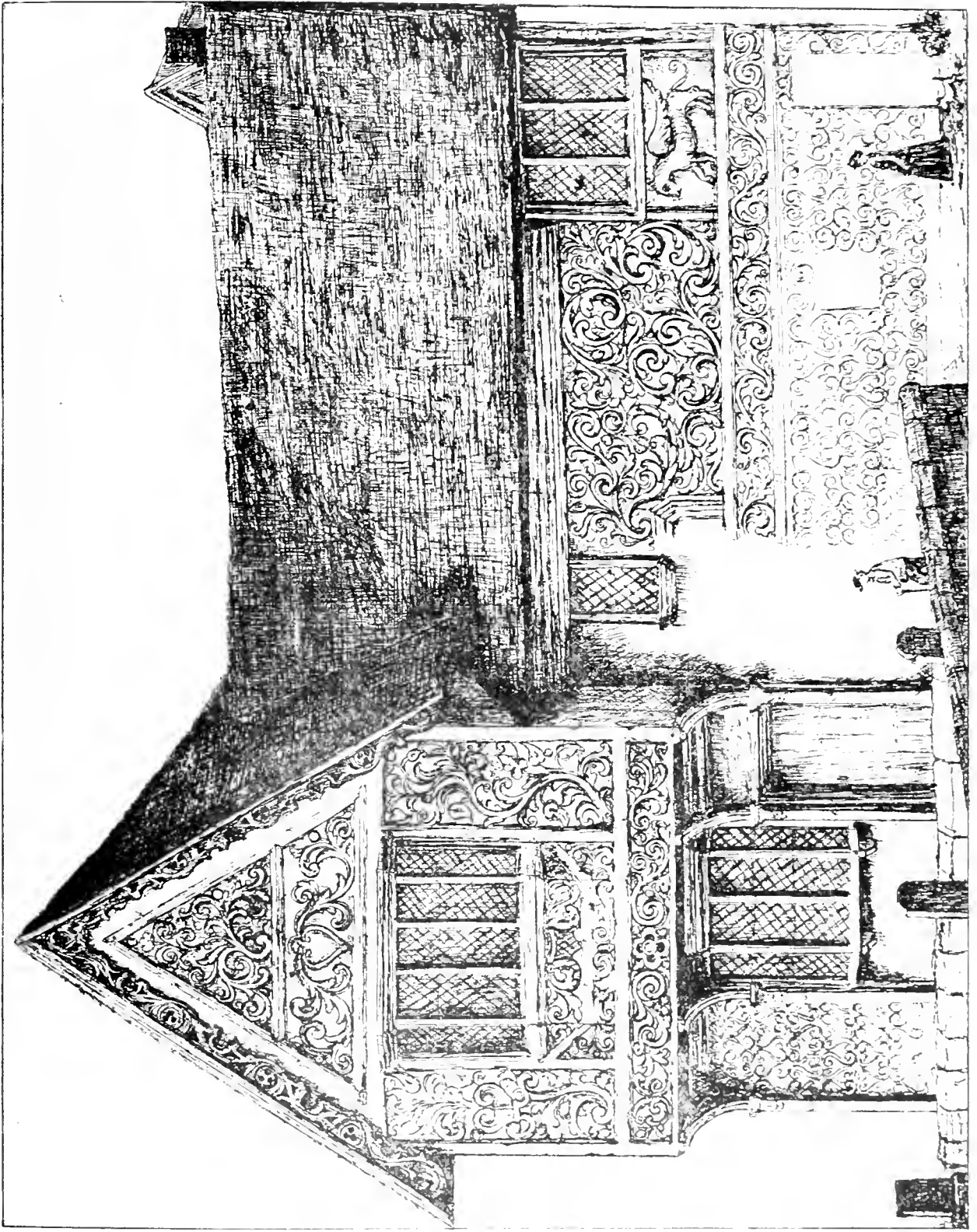

INTERNAL PLASTER WORK, ANCIENT HOUSE IN CLARI, SUFFOLK, 1473.

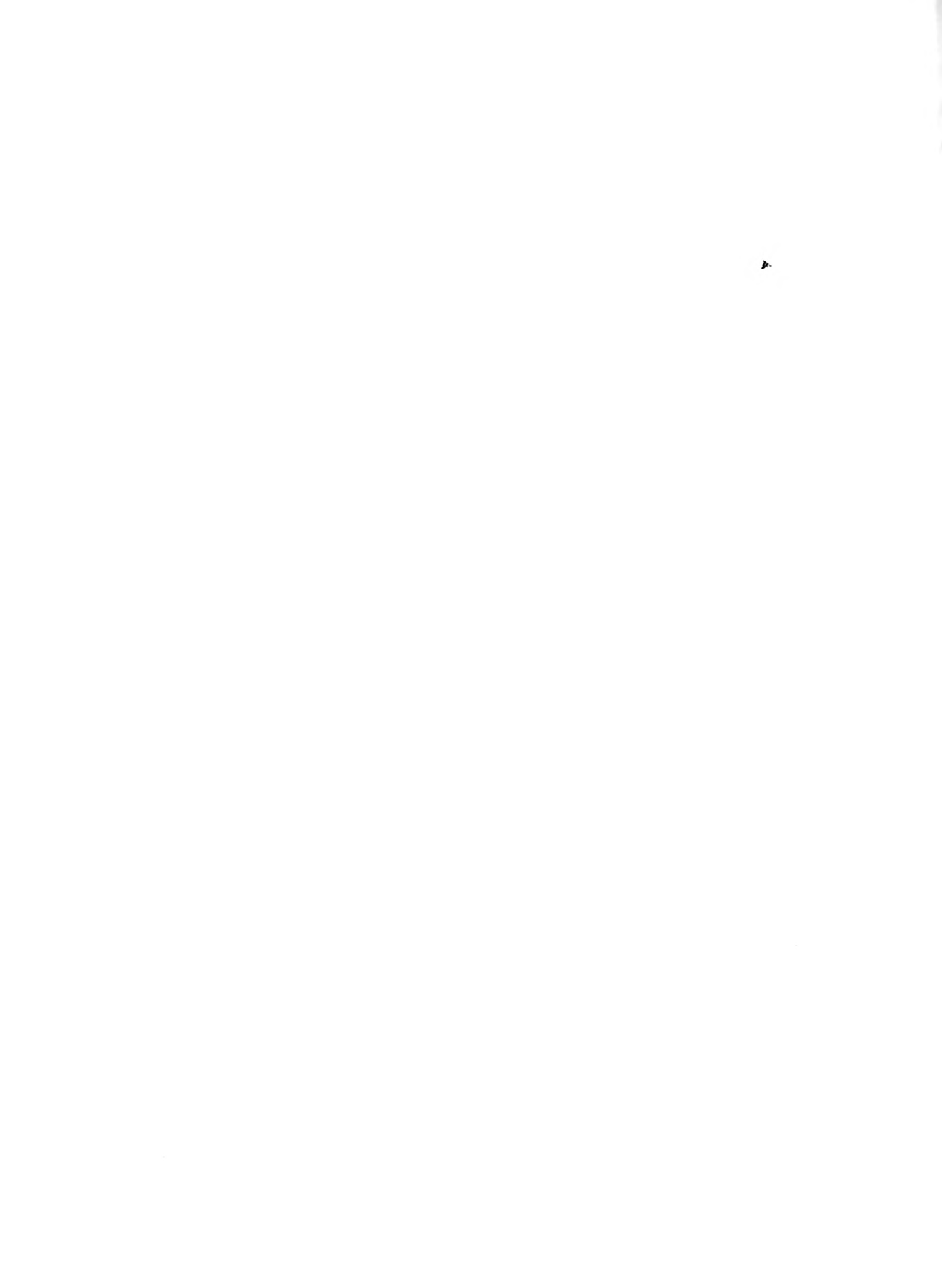

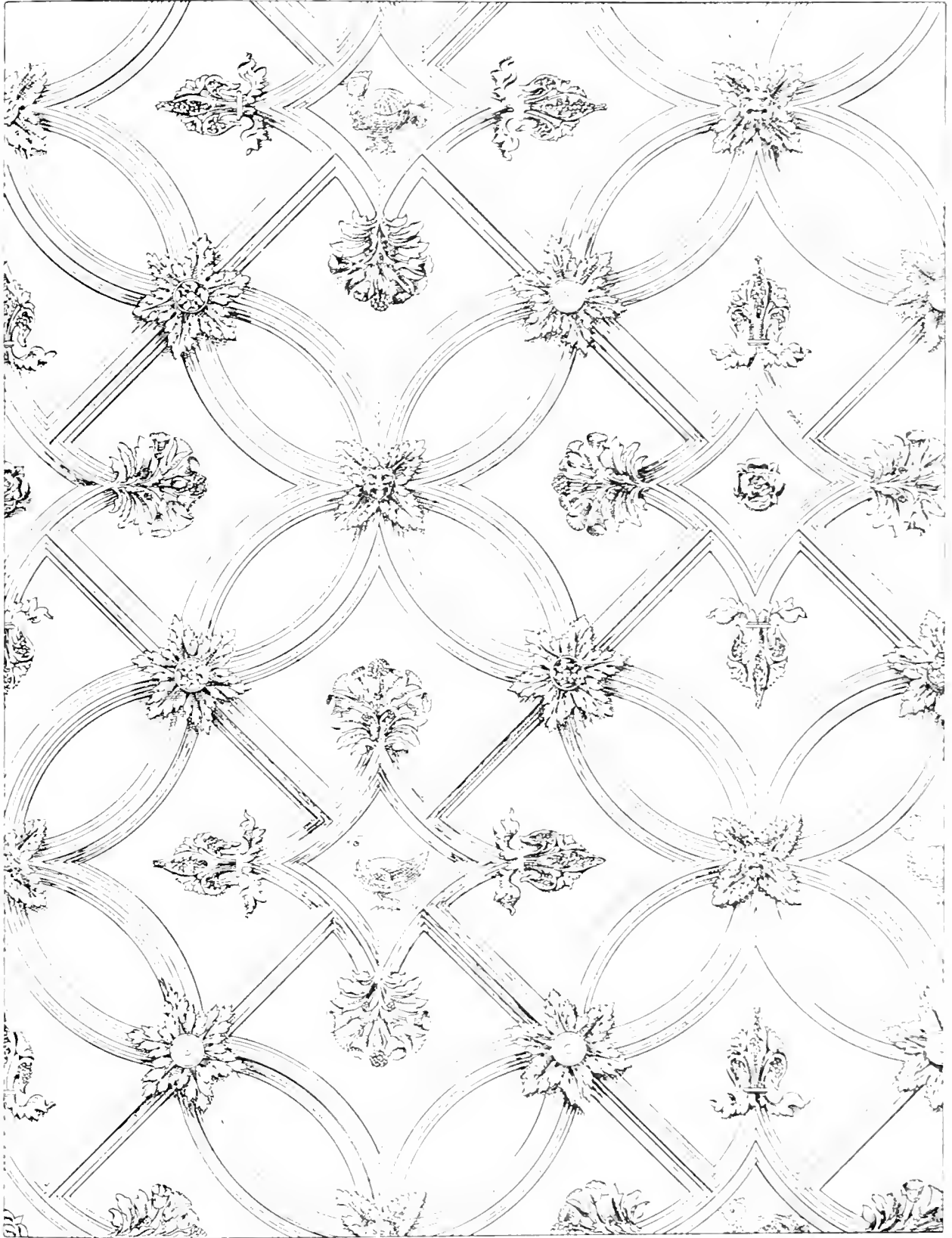

PORTION OF PLASTER CEILING. LOSELY HOUSE, NEAR GUILDFORD, 1562.

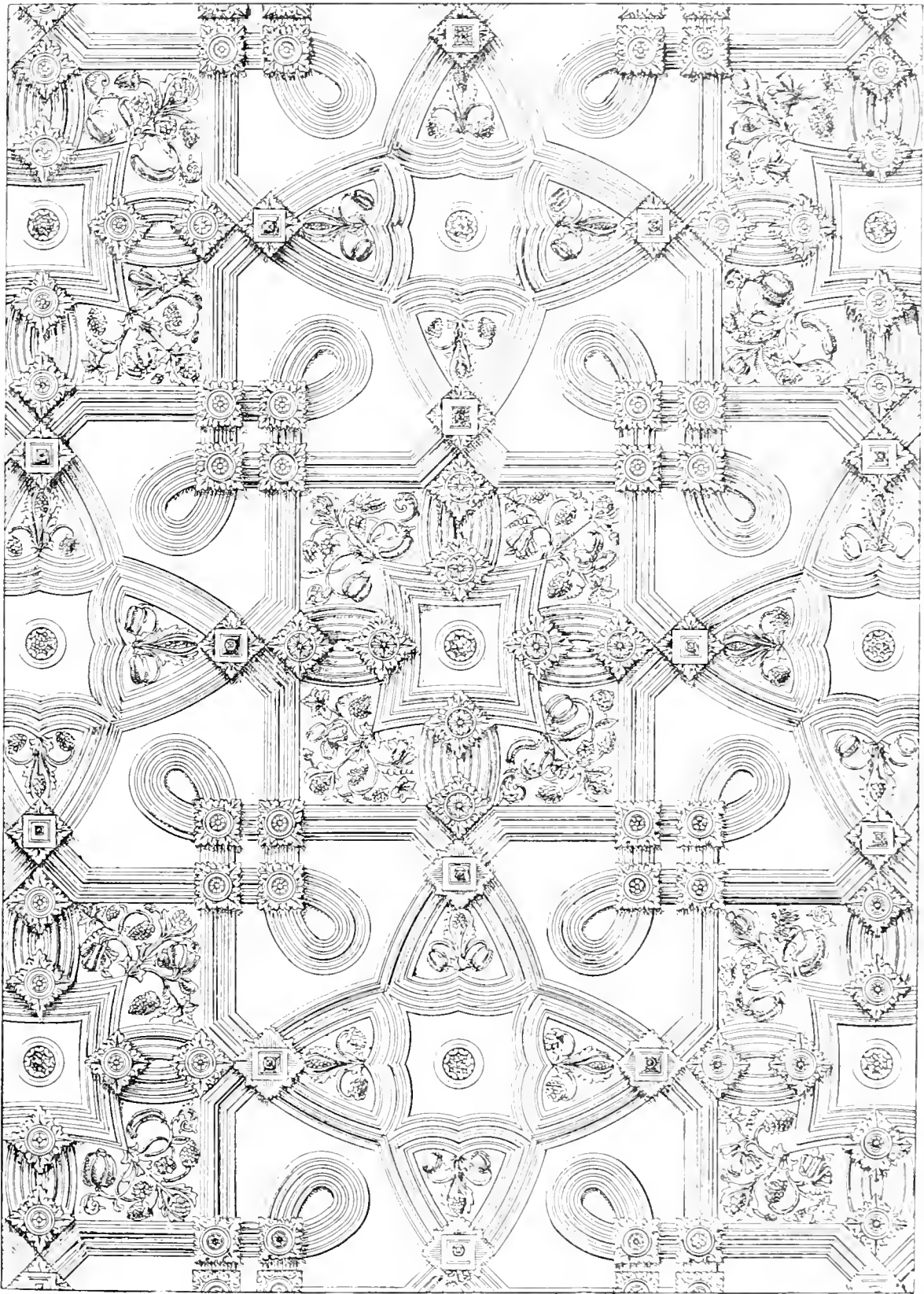

PORTION OF PLASTER CEILING, COOPER'S HOUSE, GREAT YARMOUTH, 1506.



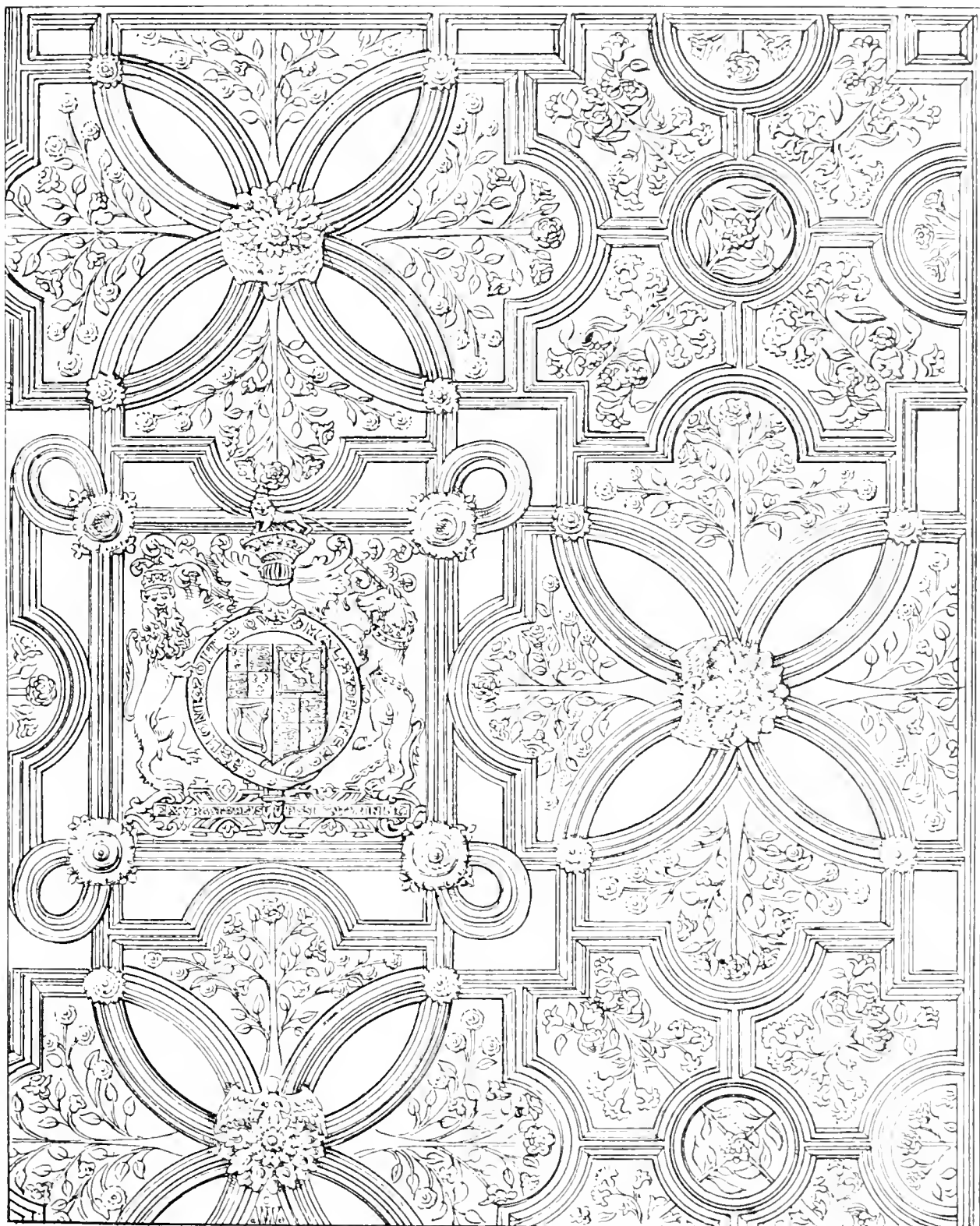

PORTION OF PLASTER CEILING, PEARTREES HOUSE, GREAT YARMOUTH. SIXTEENTH CENTURY.

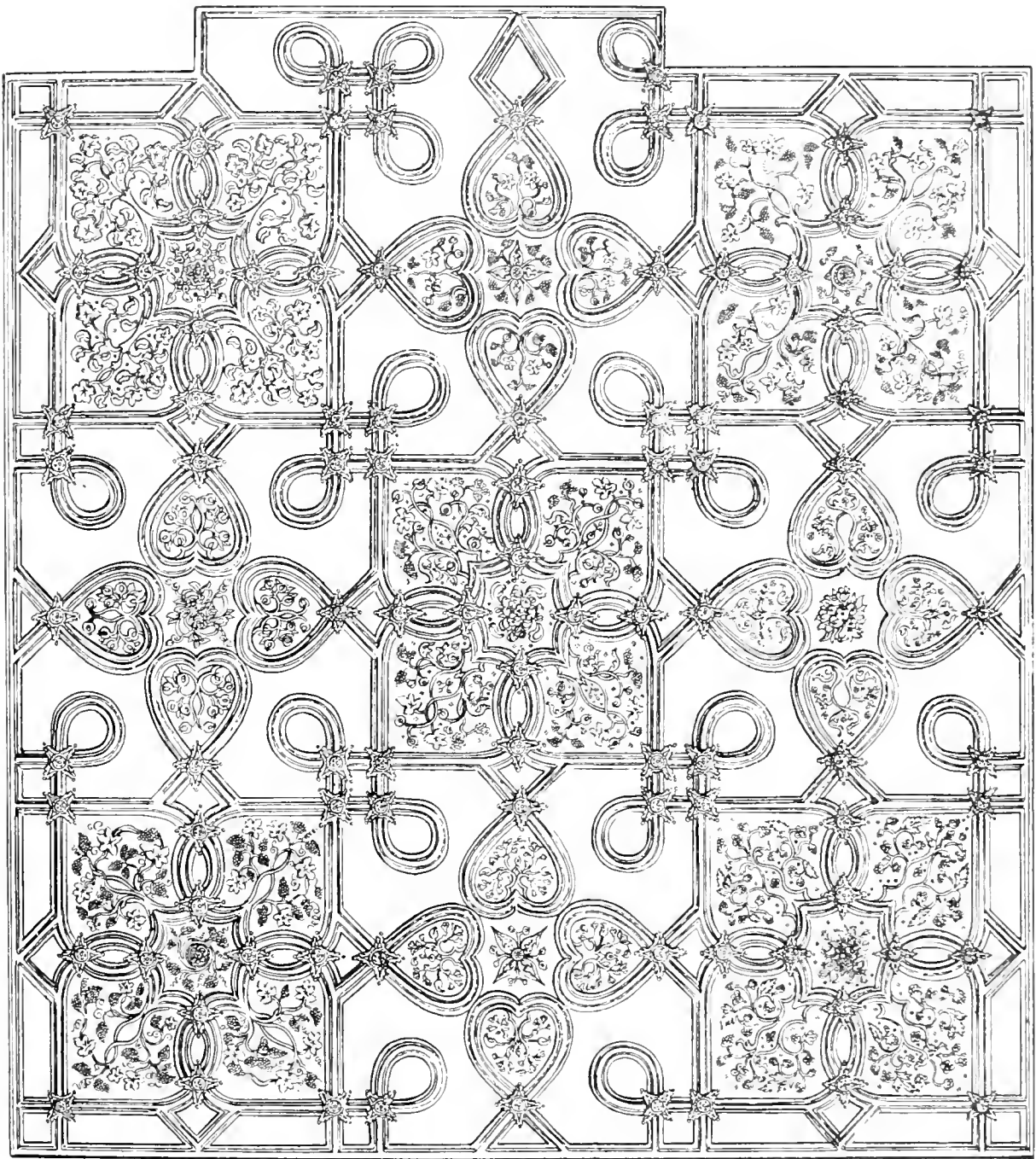

1 2 3 4 5
Scale of Feet

PLASTER CEILING, 4 SOUTH QUAY, GREAT YARMOUTH, SIXTEENTH CENTURY.

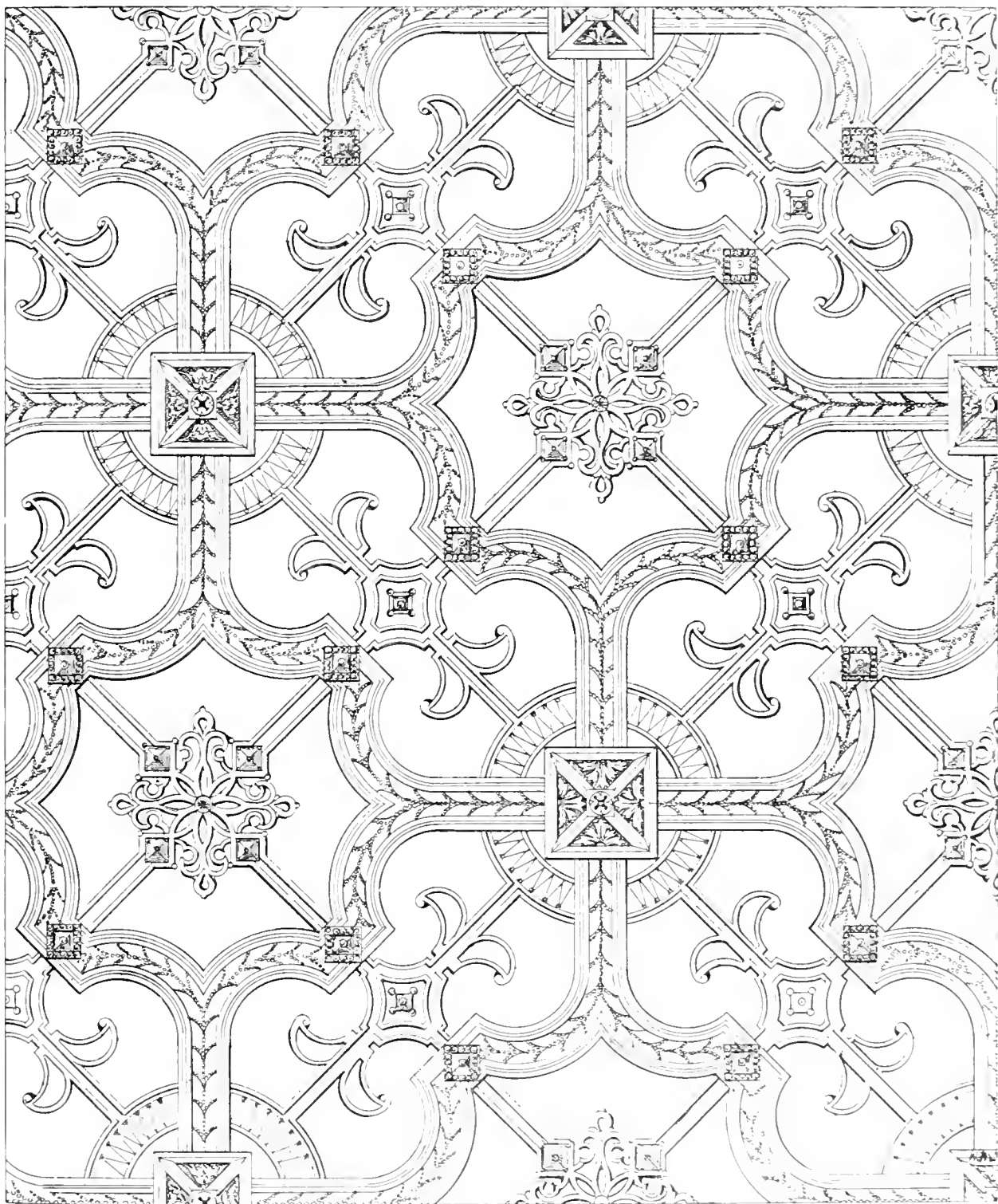

PORTION OF PLASTER CEILING, BRAMSHILL HOUSE, HAMPSHIRE, 1693.

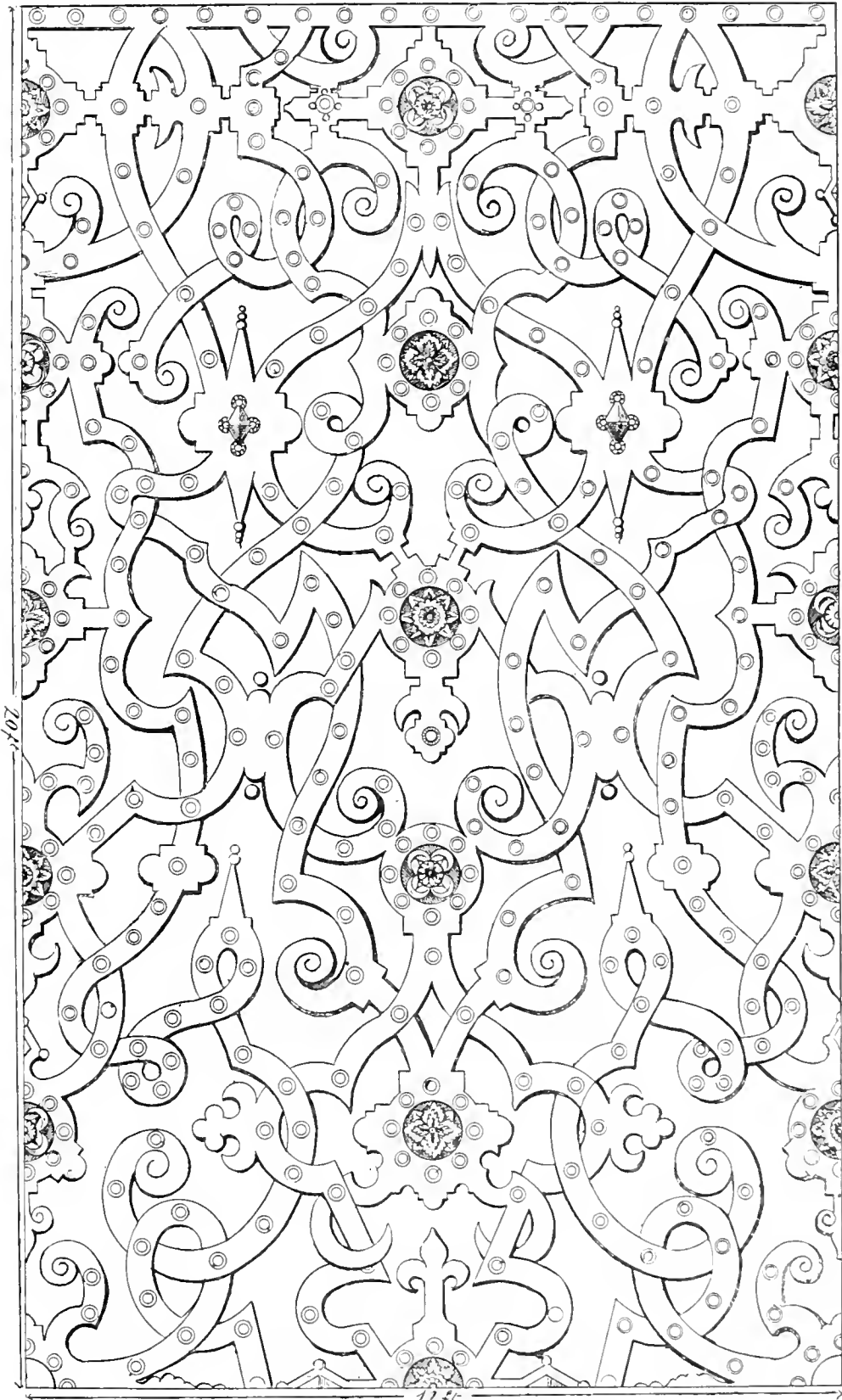

PORTION OF PLASTER CEILING, AUDLEY END, 1610.



FIG. 2.



FIG. 1.

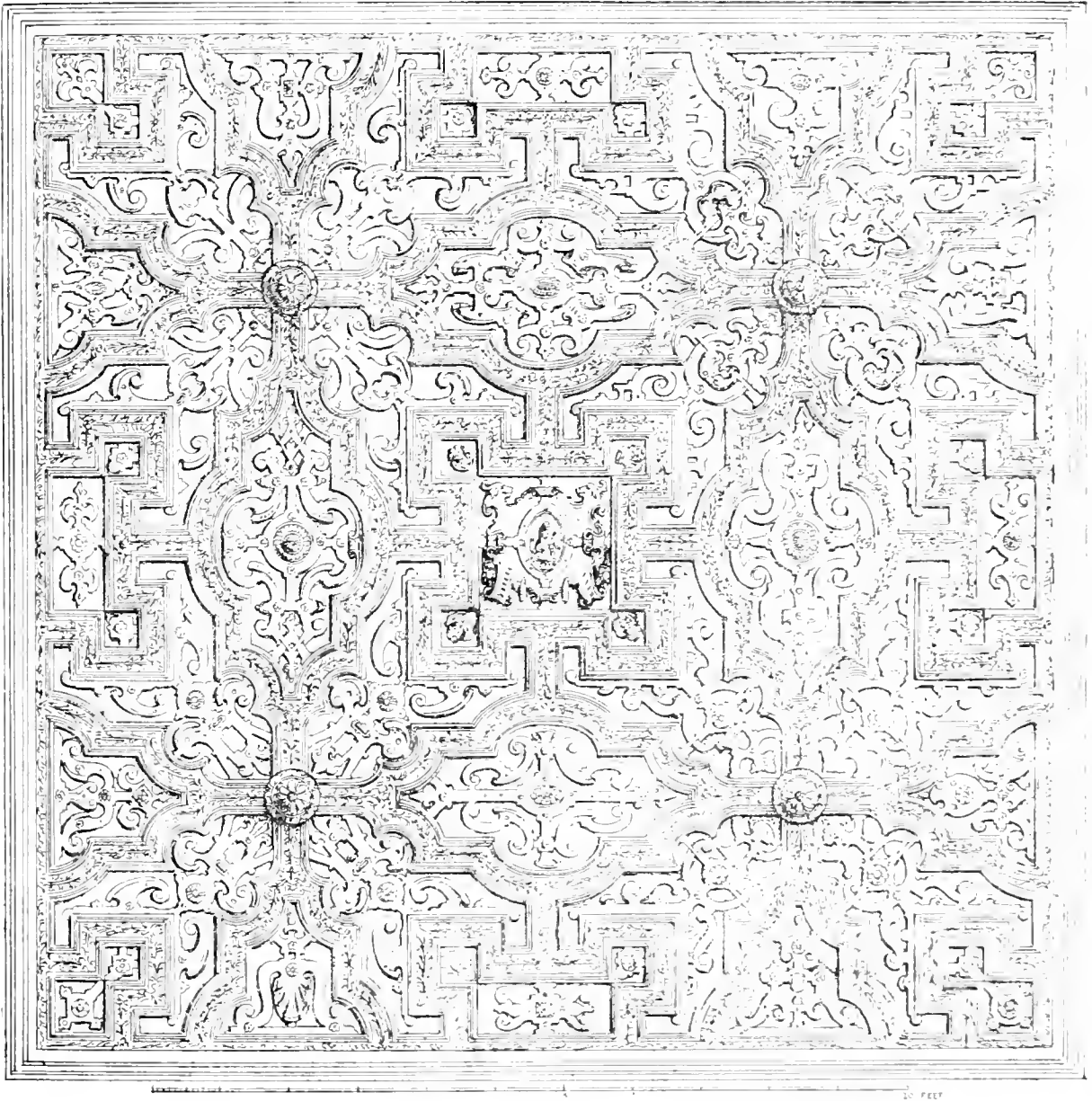
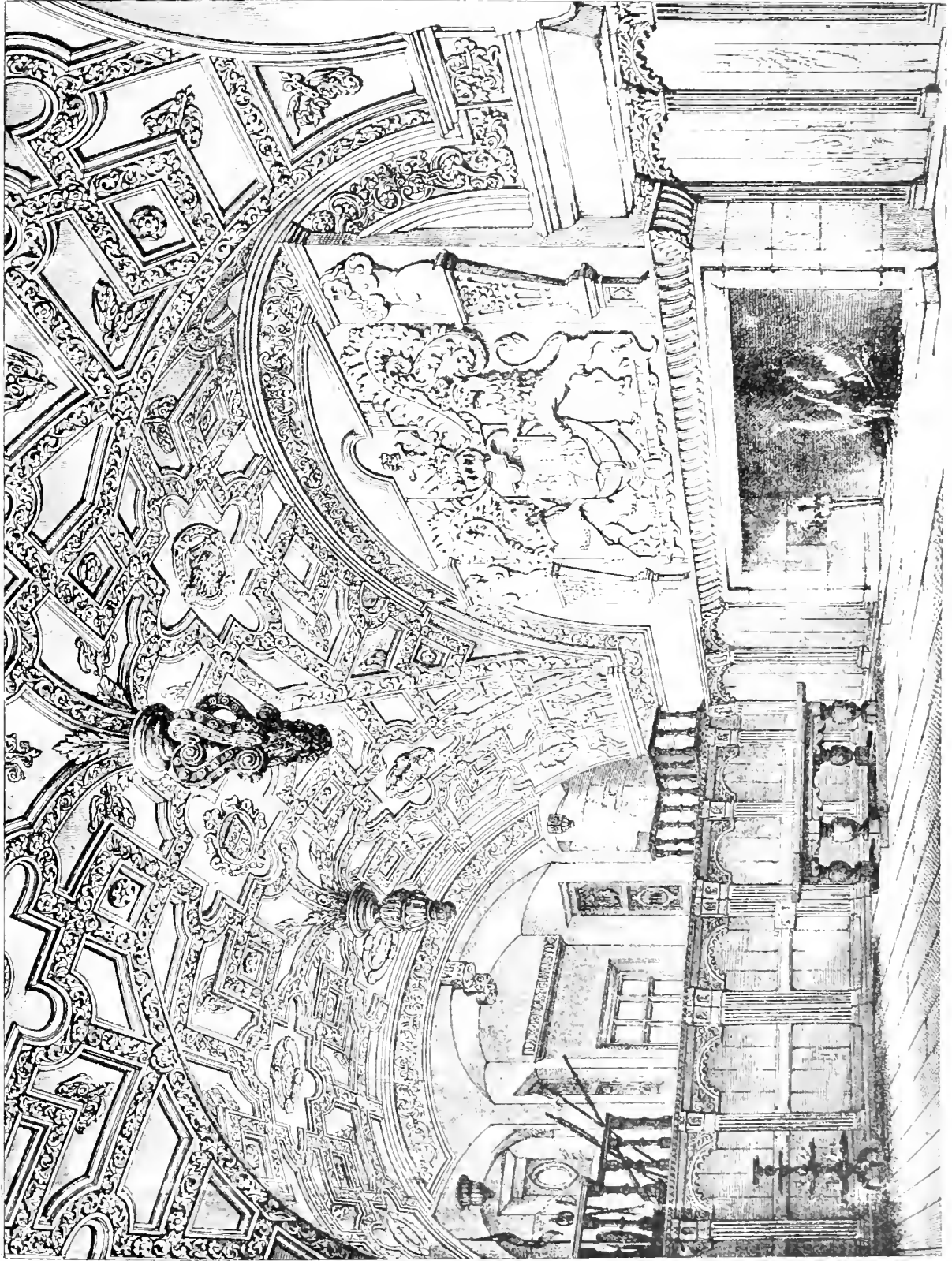

FIG. 3.

PLASTER CEILING, STATE BED-CHAMBER, BOSTON HOUSE, 1023.



PAPER CHILING, CHAGDWAR, ABERDEENSHIRE, 1611.



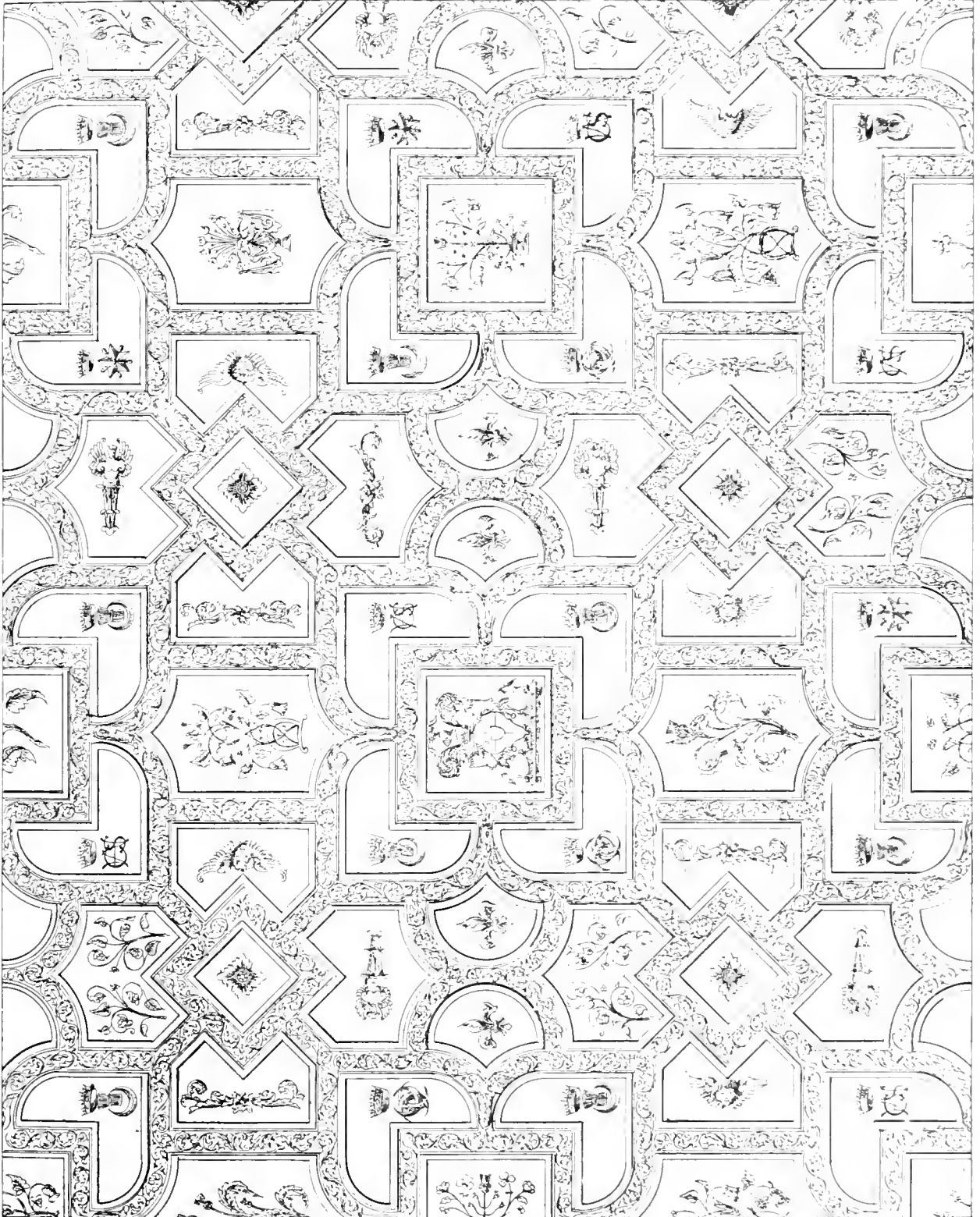

PORTION OF PLASTER CEILING, WINSTON HOUSE, MIDDLETOWN, 1620.



STEFANO CEHINO, HOLYROOD PALACE, EDINBURGH, 1671.

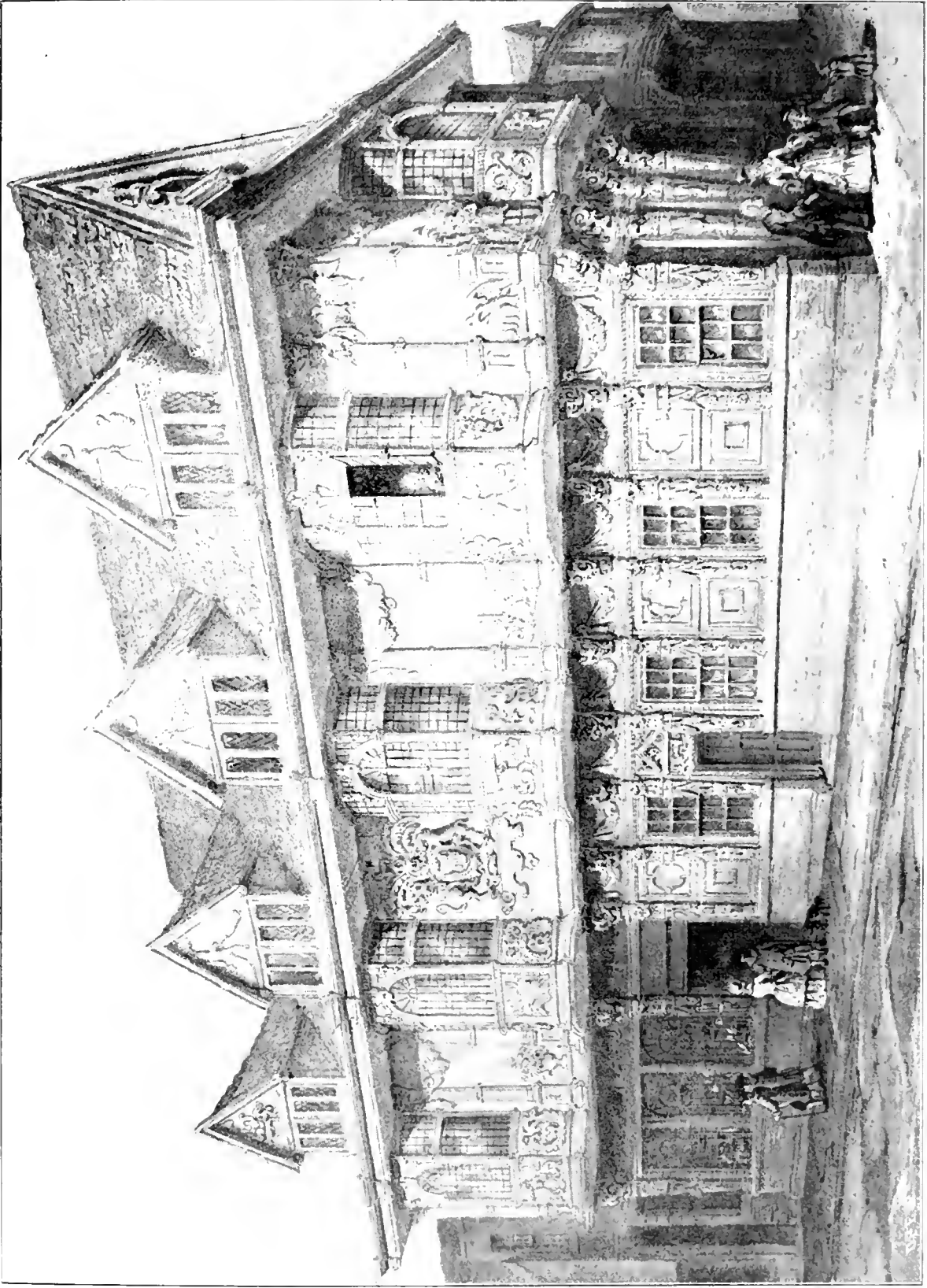
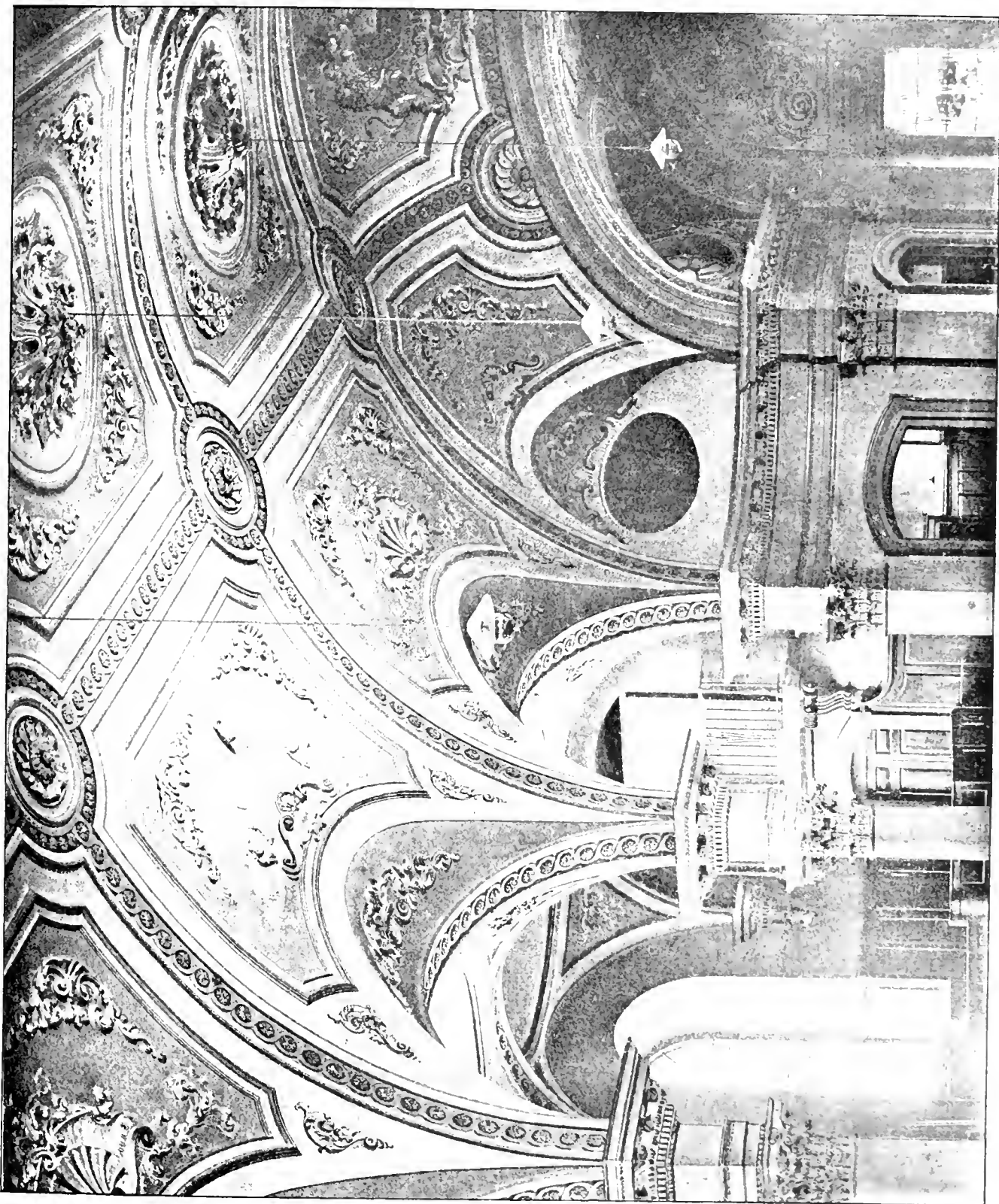
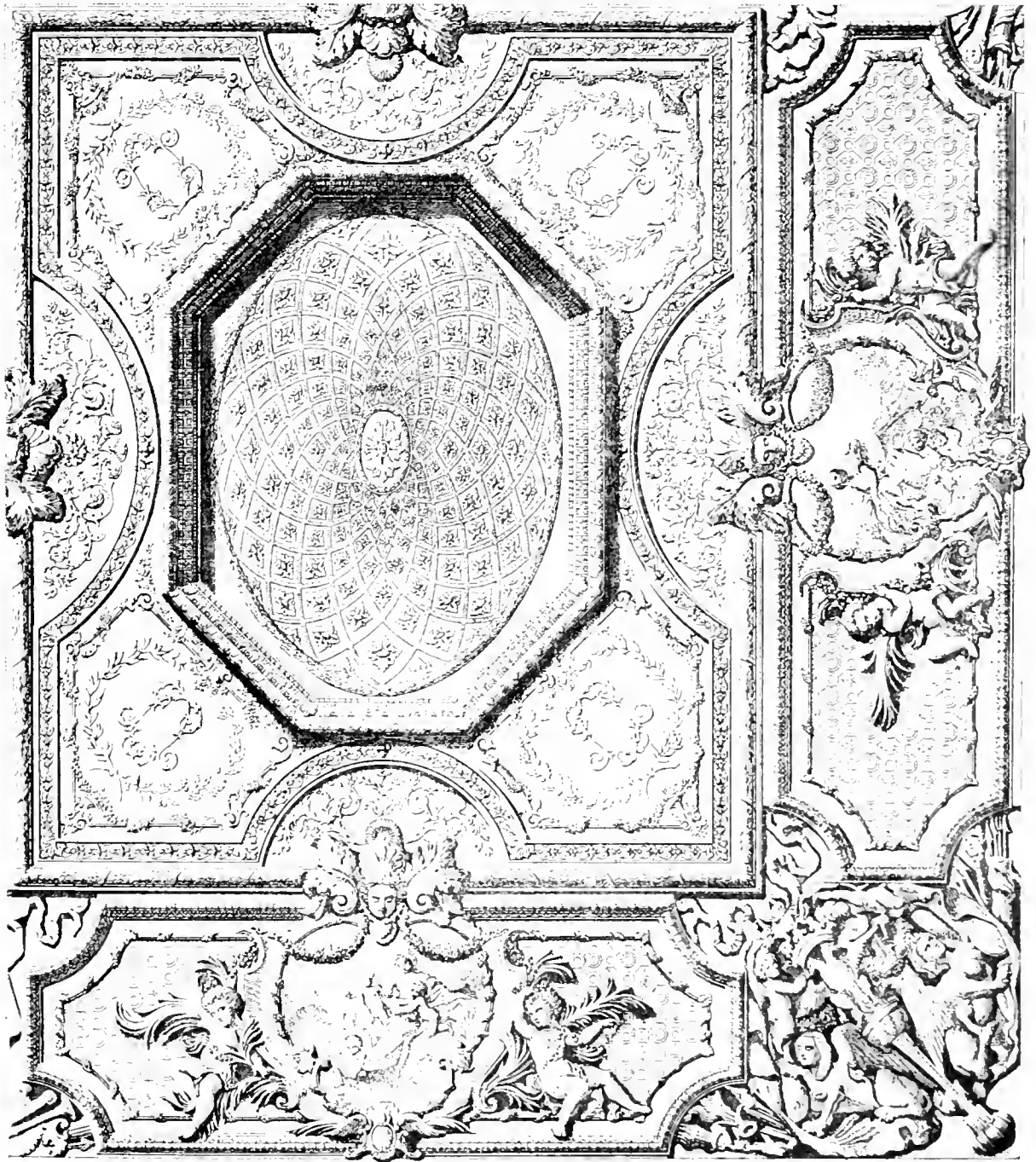

EXHIBIT PLASTER WORKS, SEARROW. FIG. 4. (FACADE), 1683.



THE CHURCH, CHURCH OF ST. MARTIN IN THE FIELDS, LONDON, 1723.

SECTION.



PORTION OF CEILING, QUEEN'S BED-CHAMBER, PALACE OF VERSAILLES, LOUIS XV.

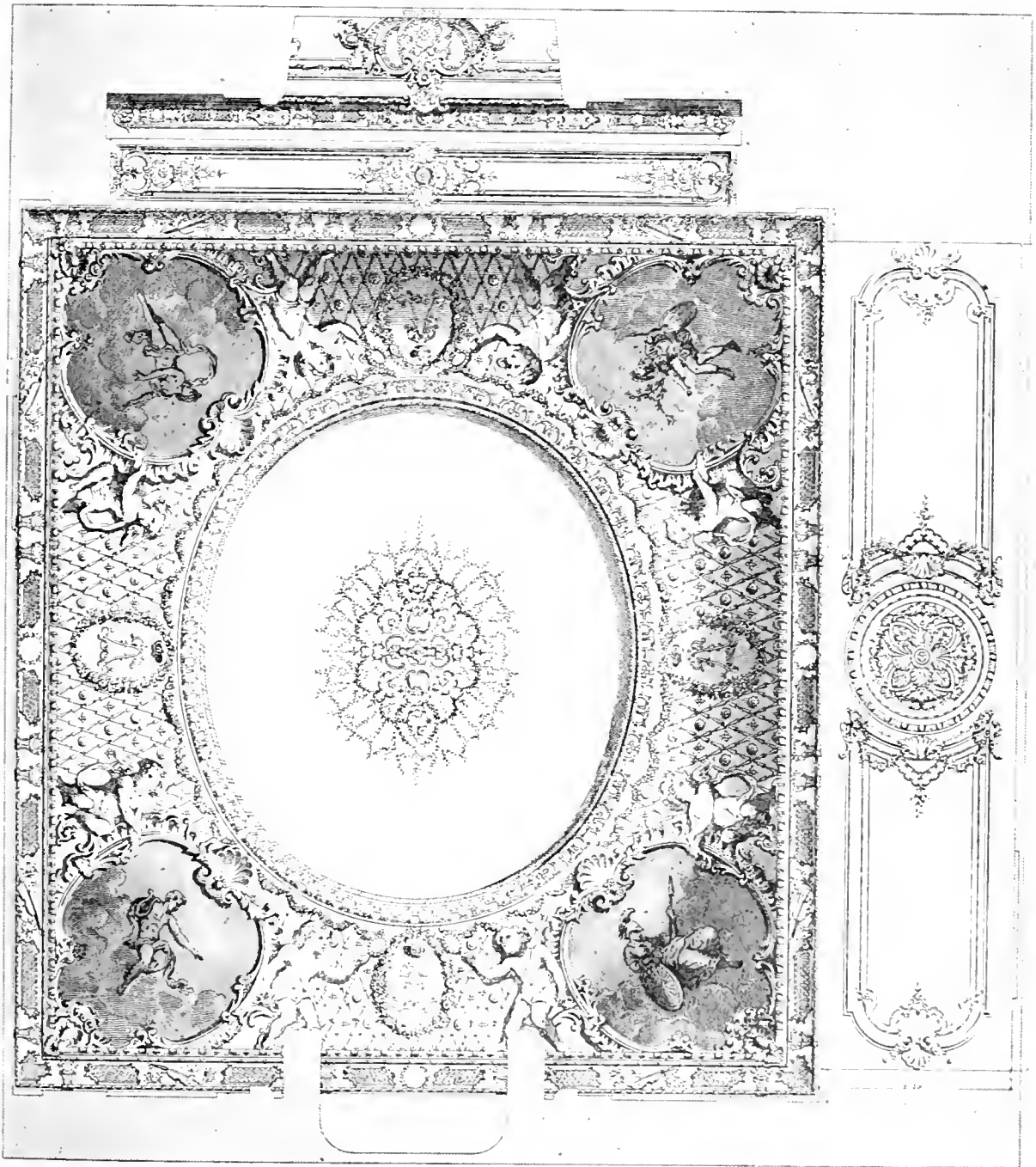

PORTION OF CEILING, SALON DES MEDAILLES, PALACE OF VERSAILLES, LOUIS XV.



PORTION OF CEILING, STUDY OF THE QUEEN OF ITALY'S VILLA, TURIN, EIGHTEENTH CENTURY.



PORTION OF PLASTER CEILING, MILTON HOUSE, CANONGATE, EDINBURGH, 1725.

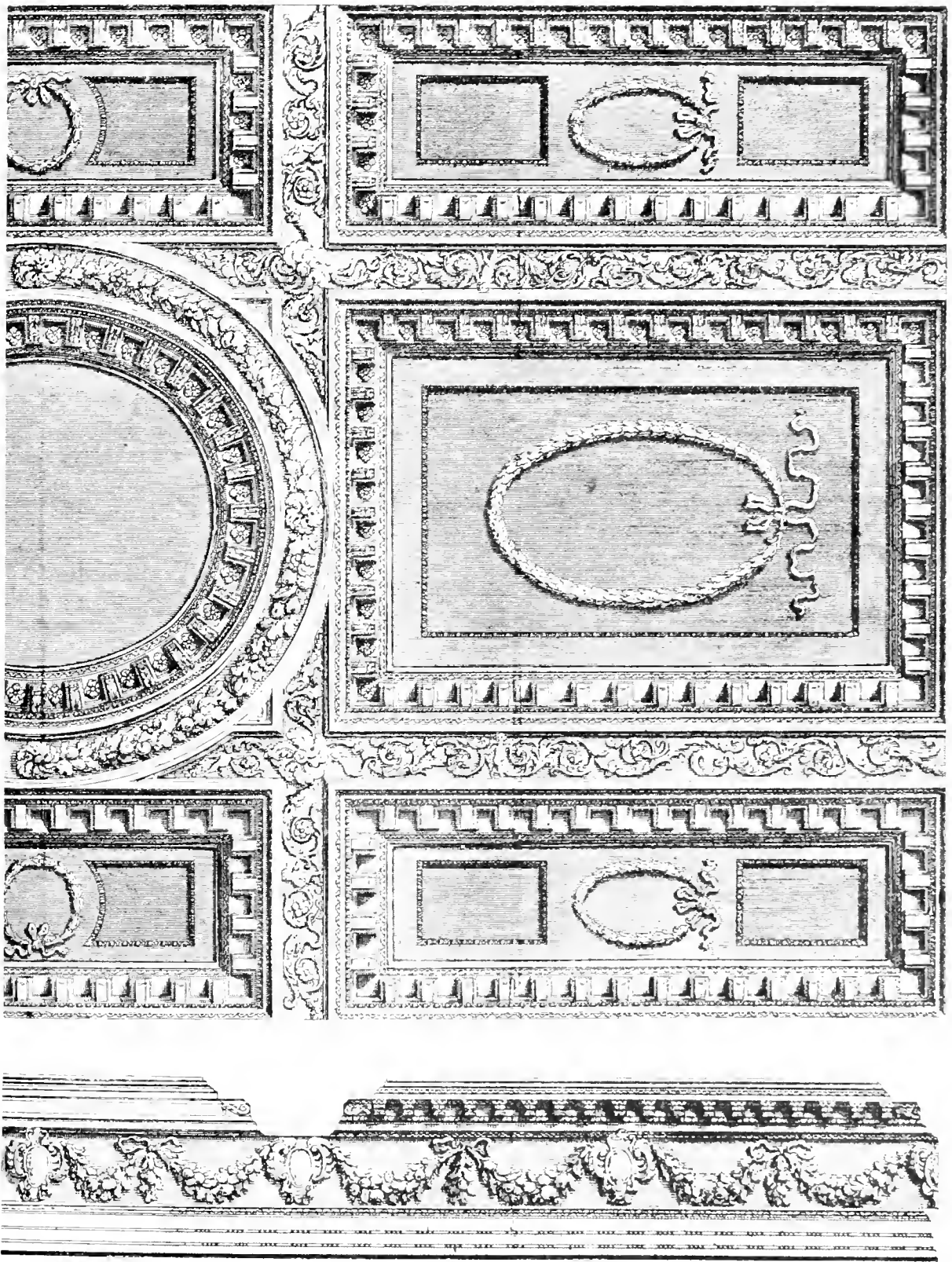

PORTION OF CEILING AND CORNICE, DINING-ROOM, COLSHILL, BERKSHIRE, 1753. (DESIGNED BY JONAS JOHNSON.)

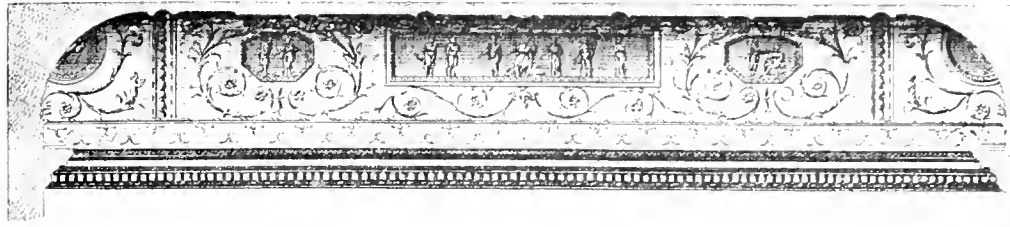

ELEVATION WITH SECTION OF GOLD PART OF CEILING.

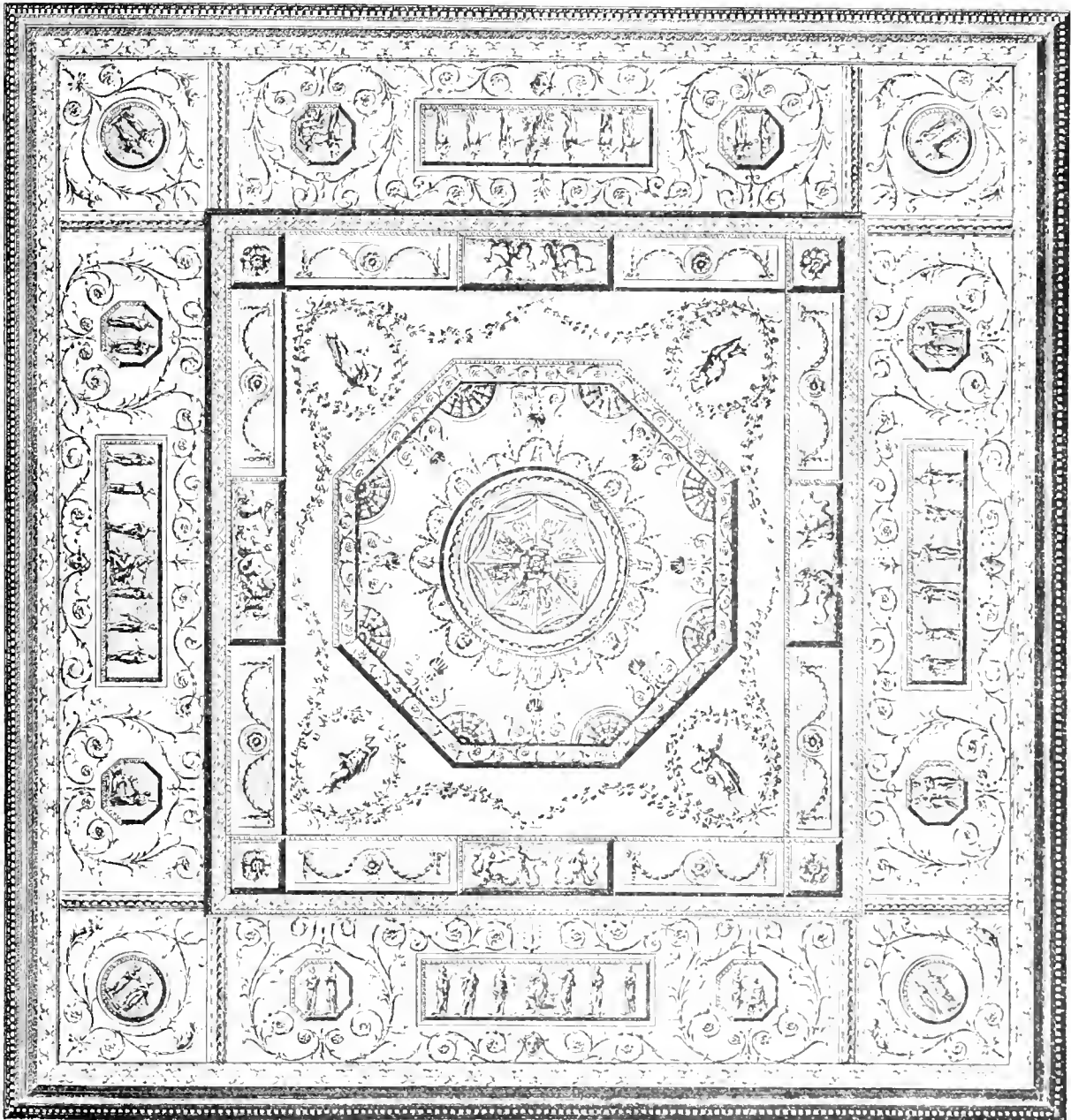

CEILING, QUEEN'S ROOM, OLD BUCKINGHAM HOUSE, LONDON, BY R. ADAM, 1769

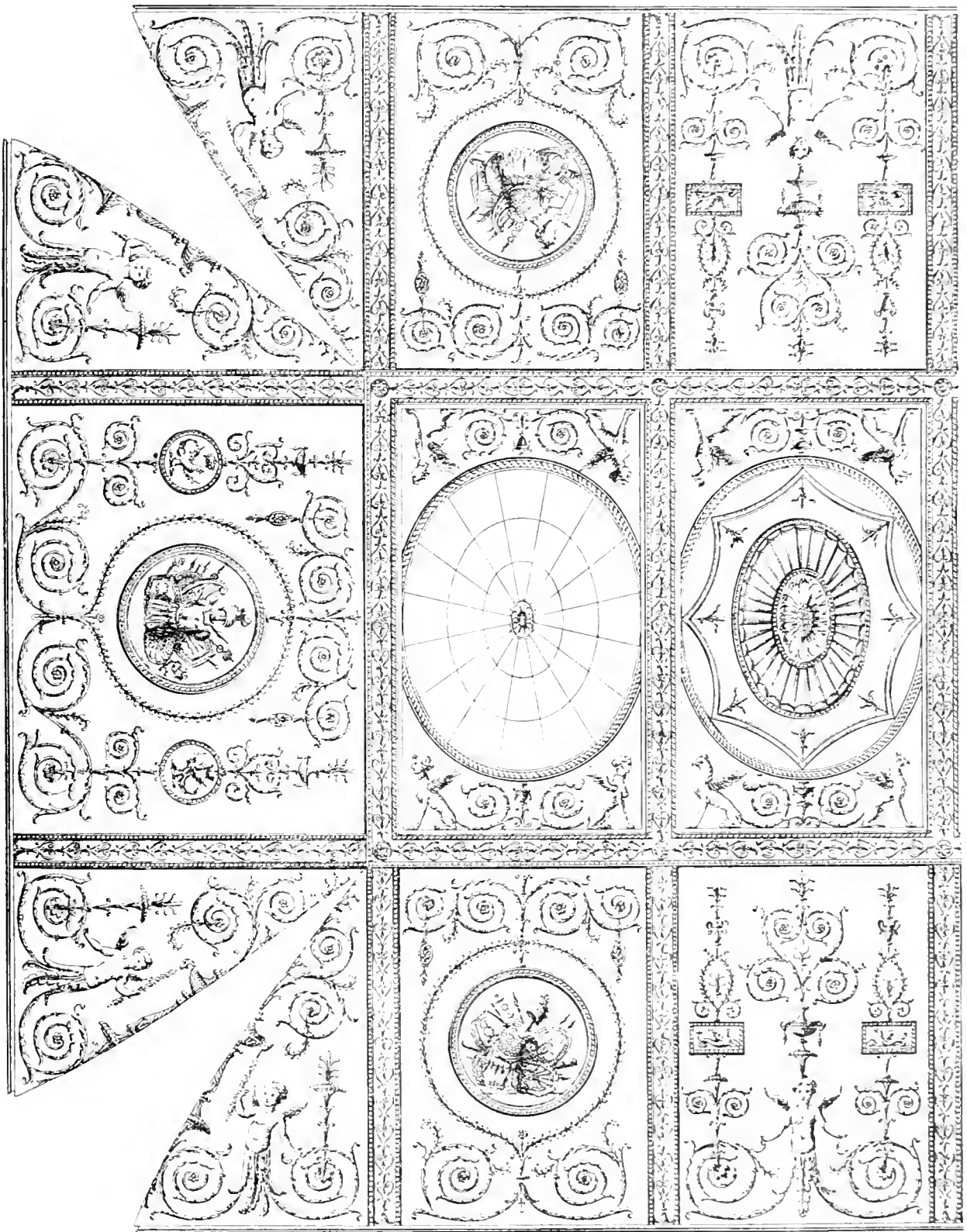

PORTION OF PLASTER CEILING, KEDLESTON, DERBYSHIRE, BY G. RICHARDSON, 1770.

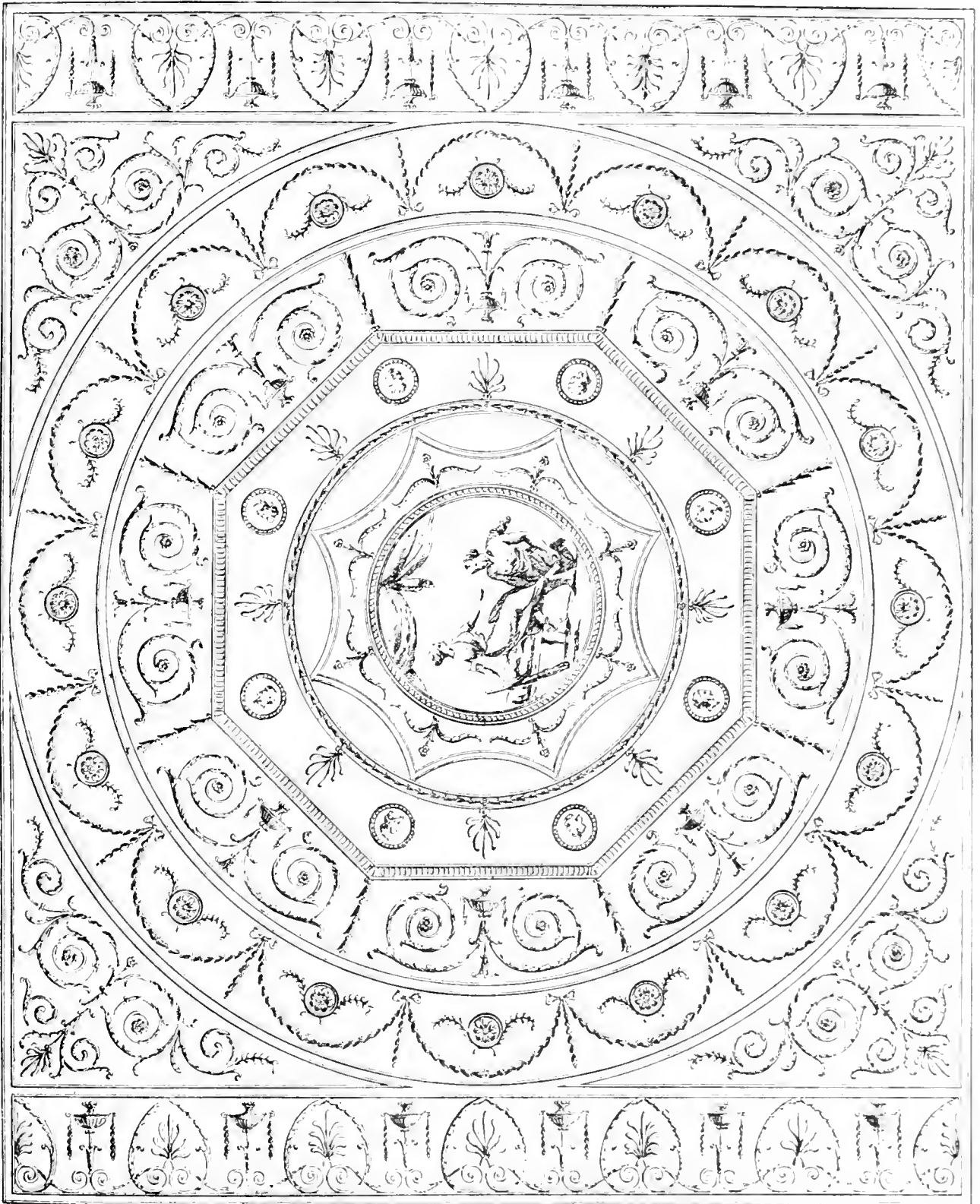

PLASTER CEILING, LORD MONTALT'S MANSION, DUBLIN, BY G. RICHARDSON, 1770.

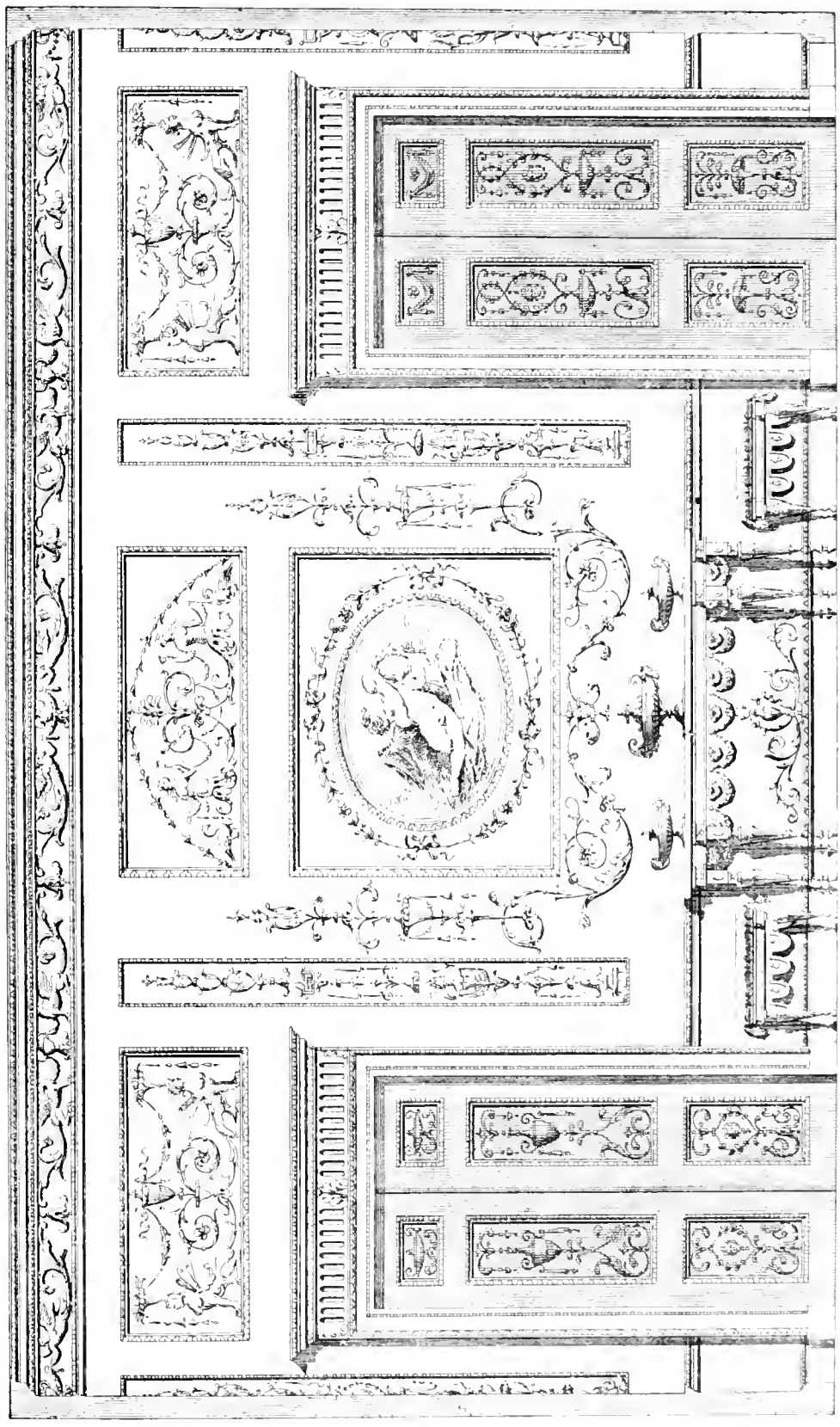

unittant

WALL DECORATION IN COMPOSITION, BY FERGOLESÌ, 1768.

CHAPTER II.

MATERIALS.

PLASTER: THE MANUFACTURE, TESTS, CHEMICAL PROPERTIES, USES, COMPRESSIVE AND ADHESIVE STRENGTH, OF PLASTER OF PARIS—LIMES: HYDRAULIC, LIAS, CHALK LIMES, MANUFACTURE, CALCINATION, SLAKING, AND TESTS—MORTAR: HARDENING OF MORTAR, MAGNESIA IN MORTAR, COARSE STUFF, LIME PUTTY, SETTING STUFF, EFFECTS OF SALT, SUGAR, AND FROST ON MORTAR, TESTS AND ADHESIVE STRENGTH OF MORTAR—HAIR: OX HAIR, FIBROUS SUBSTITUTES FOR HAIR—SAND: PLT, RIVER, AND SEA SANDS—MASTIC: SCOTCH AND LONDON MASTICS, MASTIC MOULDINGS, HAMELLIN'S MASTIC, MASTIC CEMENT—STEAPATE OF LIME.

PLASTER OF PARIS.—Gypsum, from which plaster of Paris is made, is a sulphate of lime, and is so named from two Greek words—*ge*, the earth; and *epsun*, to concoct, *i.e.*, concocted in the earth. In Italy it is known by the name of *gesso*; in Scotland it is called *stucco*; in America it is known as *calcined plaster*; and in the English trade as *plaster*. The term "plaster" will henceforth be used in this book. The writings of Theophrastus and other Greek authors prove that the use of plaster was known to them. A stone, called by Theophrastus *gypsox*, chiefly obtained from Syria, was used by the ancients for converting into plaster. Gypsum is mentioned by Pliny as having been used by the ancient artists, and Strabo states that the walls of Tyre were set in gypsum. The Greeks distinguished two kinds—the pulverulent and the compact. The latter was obtained in lumps, which were burnt in furnaces, and then reduced to plaster, which was used for buildings and making casts.

Gypsum is found in most countries—Italy, Switzerland, France, Sicily, the United States, and some of the South American States; also in Newfoundland and Canada. The latter is said to be the finest deposits in the world. It is found in this country in the counties of Derbyshire, Cheshire, Nottingham, Cumberland, and Westmoreland. The finest gypsum is called "alabaster," and is soft, pure in colour, and fragile. This white translucent material is a compact mass of crystalline grains, and is used for making small statuary, vases, and other ornaments. Gypsum is found in immense quantities in the Tertiary strata of Montmartre, near Paris. This gypsum usually contains 10 per cent. of carbonate of calcium, not always in intimate union with the sulphate, but interspersed in grains. This sulphate gives the Paris plaster some of its most useful properties. Pantin, near Paris, has large beds of gypsum, one bed being horizontal and over 37 feet thick.

The term "Plaster of Paris" was mainly applied to it because gypsum is found in large quantities in the Tertiary deposits of the Paris basin. Another reason is that lime and hair mortar is seldom used in Paris for plaster work, plaster of Paris being used for most kinds of internal and external work. Plaster is known in the colour trade as *terra alba*. Plaster of Paris was known in England by the same name as early as the beginning of the thirteenth century. The gypsum, in blocks, was brought from France, and burnt and ground here. It continued to be burnt and ground by the users until the middle of the present century. The burning was done in small ovens, and the grinding in a mill, sometimes worked by horse-power, or more often by hand.

Messrs J. Ramage & Son, of Edinburgh, with whom I served a part of my apprenticeship, burnt and ground their own plaster. I remember well that on more than one occasion I had to do a turn at the handle of the grinding machine as a punishment for some boyish indiscretion.

Plaster is the most vigorous as it is the oldest vehicle for carrying down generation after generation the masterpieces of art with which the golden age of sculpture enriched the human race. For reproductive uses, plaster enables youth to contemplate antiquity in its noblest achievements. To-day plaster is revolutionising industrial art for us, and in all probability for those who are to come after us. Plaster, lowly and cheap, but docile and durable, is the connecting agent with this greatest of men's endorsement in the past. Plaster thus employed in duplicating works of marble, pottery, and metal work, is to-day extending the finest industries, modern and ancient. Plaster is one of the best known fire-resisting materials for building purposes. After the conflagration at Paris, it was found that beams and columns of wood which had been plastered were entirely protected from fire. In cases where limestone walls had been ruined on the outside by the flames passing through the window openings, the same walls internally escaped almost unscathed owing to their being protected with plaster. Plaster in some climates has great lasting properties. The Egyptians covered their granite sometimes, and sandstone always, with a thin coating of stucco. The Greeks coated even their marble temples with plaster, and the plaster portions are now in better preservation than the unprotected masonry, particularly at Agrigentum in Sicily.

MANUFACTURE.—The gypsum is got by blasting, and by crowbars and picks. The only preparation which it undergoes before calcining consists in chipping and cleaning the outer portions if earthy, which would give the plaster a bad colour. The finest and whitest gypsum is selected for fine plaster, the darker and coarser being used for coarse plaster. There are two processes for manufacturing plaster in this country, viz., "boiled" and "baked."

BOILED PLASTER.—By the boiled process, the gypsum, after being quarried, is broken by means of a pulveriser, and then carried up by an elevator into a hopper, from which it is conducted down again by a spout to a pair of millstones, the feed being regulated by means of a small spindle attached to the cross-bar of the stones, which in revolving are made to agitate the spout, and cause the gypsum to fall in a regular stream between the stones. After grinding, the gypsum is again elevated into hoppers, which supply a large open pan or boiler to a depth of about 3 inches. The pan has large flues underneath it, heated by a furnace at one end. The gypsum is kept in agitation on this boiler by means of a pair of rakes attached to a spindle, which revolves by machinery. After it has been on the boiler for about an hour and a half, the powder becomes agitated by means of the heat, and small volcanic-like eruptions take place, through the water of hydration being driven off. At the expiration of about three hours, the powdered gypsum becomes more dense and sand-like, lying heavy on the scrapers or rakes. This is termed by the makers as "just caught," and an experienced plaster boilerman knows by the way the powder hangs when it is ready. As soon as the latter is complete, a slide which forms one of the side plates of the boiler is drawn, and the plaster is thrown off by the circular motion of the scraper. It is then left to cool, and afterwards bagged up for commerce.

The waste of gypsum in evaporation and dust which takes place in the process of boiling is about 25 per cent. Boiled plaster is fine in texture, works very free, and when set is not liable to warp. It is also generally more reliable than baked, from the fact that each molecule is properly treated, and the material alike throughout. If the powdered gypsum is left too long on the boiler, it is burned, and will not set for a considerable time, if at all. It is also very "chalky," and if it

is not boiled enough it is also weak, so that the greatest care and experience is necessary in the boiling of plaster.

BAKED PLASTER.—For the baked process, several methods of heating the gypsum are adopted. A flat kiln or oven, so constructed that the fuel is never in contact with the stone, is generally used. The kiln is raised to a low red heat, when the firing is discontinued, and the kiln charged with lumps of gypsum. The heat is then gradually increased. After about sixteen hours the gypsum has lost its water of hydration, and after grinding becomes plaster. The kiln is sometimes worked continuously, and is heated by flues carried round the kiln. When this method is adopted, it is necessary to observe that the temperature does not rise too high, and that the plaster is drawn as soon as the water has been evaporated. Great experience is required in carrying out this process (which is simply one of dehydration) successfully, for although, when the temperature is kept within proper limits, the plaster possesses the power of reabsorbing water with avidity, this power is diminished if the gypsum be overheated. When subjected to a red heat, the gypsum increases in density, and if this temperature be continued it gradually assumes the character of natural anhydrite, which has totally different properties to those of plaster. It is safer not to drive off the whole of the water rather than risk exposing the gypsum to too high a temperature, as the retention of a small portion of moisture does not prevent the plaster from reabsorbing the water that has been driven off. The time required for burning depends greatly upon the quantity and hardness of the stone in the kiln. It is considered to be sufficiently baked when the plaster is of an oily nature, and adheres to the workman's fingers.

QUICK AND SLOW SETTING PLASTER.—M. Landrin, in giving the results of his long continued studies relative to the different qualities of gypsum, states that the more or less rapid setting of plaster is due to the mode in which it is burned. Its properties are very different when prepared in lumps or in powder. The former when mixed in its own weight of water sets in five minutes, while the latter under similar conditions takes fifteen minutes. The reason probably is that plaster in powder is more uniformly burned than when it is in lumps, which tends to prove this fact, that when the latter is exposed longer than usual to the action of heat it sets more slowly. Gypsum prepared at a high temperature loses more and more of its affinity for water, retaining, however, its property of absorbing its water of crystallisation. Plaster heated to redness and mixed in the ordinary manner will no longer set: but if, instead of applying a large quantity of water, the smallest possible portion is used—say one-third of its weight, it will set in ten or twelve hours, and becomes extremely hard. To prepare good plaster, it should not be burned too quick to drive off all its moisture, and for its molecules to lose a part of their affinity for the water. If the plaster is exposed to heat until it has only lost 7 or 8 per cent. of its moisture it is useless, as it sets almost immediately. If, however, the burning is again resumed, the substance soon loses its moisture, and if then exposed to the air it very rapidly retakes its water of crystallisation, and absorption continues more slowly. It then sets slowly, but attains great hardness.

TESTING.—The quality of plaster may be tested by simply squeezing it with the hand. If it cohere slightly, and keeps in position after the hand has been gently opened, it is good; but if it falls to pieces immediately, it has been injured by damp. Although plaster does not chemically combine with more than one-fourth of its weight of water, yet it is capable of forming a much larger quantity into a solid mass, the particles of plaster being converted into a network of crystals, mechanically enclosing the remainder of the water. Sulphate of lime (plaster) is soluble in water to the extent of 1 part in about 450, the solubility being but little influenced by temperature.

It is on account of this solubility in water that cements which have to a large extent plaster for their basis are incapable in this raw state of bearing exposure to the weather. The setting of plaster is due to hydration, or its having but little water to take up to resume a state of consolidation. Plaster is used with hydraulic limes to stop the slaking, and convert the lime into cement. These are then called "selenitic."

In 100 parts of gypsum there are 40 acid, lime 32, and water 22 parts. Good plaster should not begin to set too soon, and it should remain for a considerable time in a creamy state. When once set it should be very hard. Plaster should set slowly, as it gives more time for manipulation, but principally because one which sets quickly and swells, never becomes so hard as slow-setting material. The quality of plaster cannot be determined by its colour, the colour being regulated by that of the gypsum; but all things being equal, the whitest and hardest generally yields the best plaster. But as the exception proves the rule, it may be mentioned that the Cumberland plasters such as Howe's are of a delicate pink tint, and of a very fine grain, and exceedingly strong when gauged. This pink plaster is much appreciated by many plasterers for making originals, as owing to its fineness and density it is very suitable for cleaning or chasing up models taken from the clay, and also for durable moulding pieces. One of the whitest plasters in England, which is also very close in texture, is that manufactured by Caffierata. For cast work the colour of plaster is of small moment, because the cast work is sooner or later coloured with paint, and moreover, unfortunately daubed over with distemper, or, worse still, with whitewash. Coarse plasters are darker in colour than fine. Coarse plasters of a sandy nature, and which rapidly sink to the bottom when put in water, contain too much silica, or improperly burnt gypsum, or are derived from a bastard gypsum, and are generally of a weak nature.

COMPRESSIVE AND ADHESIVE STRENGTH.—The compressive resistance of properly baked plaster is about 120 lbs. to the square inch when gauged with neat water, and 160 lbs. when gauged with lime water; thus showing that lime water hardens and improves the affinity of plaster. The adherence of plaster to itself is greater than to stone or brick. The adhesion to iron is from 24 to 37 lbs. the square inch.

FRENCH PLASTER.—A considerable quantity of French plaster was formerly used in London; but owing to the English plaster being now more uniform in quality and cheaper in price, the use of the French material is somewhat limited. A considerable quantity of gypsum is imported to Bristol from France. The stone is manufactured at Bristol, and has all the superior qualities of French plaster. This is generally known as "Bristol plaster." Benvenuto Cellini preferred the French plaster to that of Italy, his own country. In Paris various kinds of gypsum mortars are in general use, raw gypsum and other materials being often intermixed. They also contain free carbonate of lime, according to the degree of heat to which the raw stone has been subjected. The *Hôtel de Plâtres*, in Paris, affords a good illustration of the constructive uses to which plaster can be put, some of the blocks being about a hundred years old.

LIMES.—Lime is one of the most important materials in the building trades. Limestone is the general term by which all rocks are roughly classified which have carbonate of lime for their basis. They are obtained from many geological formations, varying in quality and chemical properties. The Carboniferous consists of nearly pure carbonate of lime. In the limestone of the Lias carbonate of lime is associated with silica and alumina (common clay) in proportions varying from 10 to 20 per cent. The best kinds are obtained from Aberthaw, Rugby, Barrow, and other districts in England; Arden, Fifeshire, and other places in Scotland; and Calp and Larne in Ireland. Carbonate of lime is found in a state of chemical purity in rhombohedral crystals as

Iceland spar. It is also found in six-sided prisms, known to mineralogists as arragonite. Its purest form as a rock is that of white marble. Coloured marbles contain iron, manganese, &c.

The Lias strata consist of a thin layer of hard limestone separated by another of a more argillaceous character, or shale, containing various proportions of carbonate of lime. The Lias districts extend from Lyme Regis to the north-east of Yorkshire; the limestone in the counties of Warwick, Dorset, and Leicester. In the chalk districts of Kent and Surrey there are in the upper chalk a soft kind of comparatively pure carbonate of lime, and in the grey chalk lying below it there is a carbonate of lime of a harder description, having a small proportion of argillaceous matter.

HYDRAULIC LIMES.—Hydraulic limes are those which have the property of setting under water or in damp places, where they increase in hardness and insolubility. The blue Lias lime formation is that from which hydraulic lime is principally obtained in England, and it is found over a wide area—at Aberthaw, and at Rugby, where it is also manufactured into Portland cement. This lime, while it has excellent hydraulic properties, can hardly be classed as a cement. The stones which produce these limes contain carbonate of lime, clay, and carbonate of magnesia. The clay plays an important part in giving hydraulicity to the lime, consequently this power is greater in proportion to the amount of clay contained in the lime. The proportion of clay varies from 10 to 30 per cent. When lime contains clay it is not so easily slaked as pure lime, and does not expand so much in doing so, and therefore does not shrink so much in setting.

Lias lime (called blue Lias from the colour of the stone from which it is produced) is very variable in quality and is generally of a feeble nature, but is sometimes of an hydraulic nature. M. Vicat divides them into three classes: feebly hydraulic, ordinary hydraulic, and eminently hydraulic. “Those belonging to the first class contain from 5 to 12 per cent. of clay. The slaking action is accompanied by cracking and heat. They also expand considerably, and greatly resemble the fat limes during this process. They are generally of a buff colour.” Those of the second class contain from 15 to 20 per cent. of clay. “They slake very sluggishly in an hour or so without much cracking or heat, and expand very little. They set firmly in a week. The eminently hydraulic limes contain from 20 to 30 per cent. of clay, are very difficult to slake, and only do so after a long time. Very frequently they do not slake at all, being reduced to a powder by grinding. They set firmly in a few hours, and are very hard in a month.”

A natural hydraulic lime, known as “Arden lime,” is found in the West of Scotland. This lime is obtained from what appears to be a sedimentary limestone that has been formed by being deposited from water which held it in solution. It is very fine grained, and contains almost no fossils, and scarcely the trace of a shell is to be seen, except at the top and bottoms of the divisions, which are four in number, and in all from 9 to 12 feet thick. When first worked, the stone was slaked in hot kilns, but now this is effected by grinding. According to the “McAra” process, the “lime shells” from the kiln are ground in the same way as the clinker of Portland cement. Beginning with a stone-breaker, the lime passes from this to a pair of chilled crushing rollers, and finally to the millstones, after which the powder is carried by screw-conveyor and elevator to a rotary screen, 12 feet by 4 feet, covered with wire-cloth, which retains and returns to the millstones any residue in excess of the required fineness. Sifting is a very important factor in the process, as it is scarcely possible to have the millstones so perfect that they will not pass a few large particles.

The residue of imperfectly ground lime will doubtless slake when mixed with water, but at long or uncertain periods, so that it is obvious that fine grinding is a necessity, and the setting properties are not fully and safely developed unless the whole is finely pulverised. With regard to

fine grinding, the expense to the manufacturer is increased in proportion to the fineness, so much so, that to reduce the lime down to a residue of 15 per cent., instead of 35 per cent., will quite double the cost of grinding. Against this, however, a reliable natural cement is obtained. On the other hand, if coarsely ground, the covering capacity, and subsequent strength of the mortar or concrete, is very much less. This hydraulic lime, tested on the same lines as for Portland cement, has a tensile strength per square inch at 7 days from 80 lbs. to 100 lbs.; 1 month, 150 lbs. to 200 lbs.; 6 months, 350 lbs. to 400 lbs.; and 3 years, 600 to 700 lbs.

The setting and hardening are mainly due to crystallisation, caused by the action of water on the silicate of lime, as shown hereafter.

The following is an analysis of hydraulic limes:—

TABLE I.—ANALYSIS OF HYDRAULIC LIMES.

	Lime.	Silica.	Alumina.	Oxide of Iron.	Magnesia.	Water, Carbonic Acid, &c.	Authority.
Aberthaw Blue Lias - - - -	78.45	9.35	6.25	trace	...	5.70	H. Faija, 1885.
Barnstone „ - - - -	59.61	20.61	6.98	4.01	2.25	6.54	J. B. Dyer, F.C.S.
Warmsworth Cliff (Yorks) Magnesian	58.4	6.56	...	1.4	38.6	1.1	F. Hudson.

CHALK LIME.—Chalk lime is a term used principally in London for fat lime. Fat lime is produced from the purest of the limestones, which are nearly pure carbonate of lime. It is also known as “pure lime” and “rich lime.” As it has little or no setting power, and is easily dissolved in water, it is unfit for any purpose where strength is required, or in situations exposed to the weather.

The general practice is for lime producers to show their lime as rich as possible by analysis, and for users to prefer a rich lime, for the reason that it makes a more plastic and better working mortar with the usual quantity of sand. Now, it has been proved by experiments, many and varied, and extending over a long period, by the most eminent authorities, French, German, and English,—most prominent amongst them Smeaton,—that this preference should exactly be reversed, and that the poorer common limes will make the best mortar, and will, in a comparatively short time, show some slight setting power, whereas the very rich limes never take band, except in so far as they return to their original condition of carbonate by the reabsorption of carbonic acid from the atmosphere, and by the slow evaporation of the water of mixture. If it does not evaporate, the mortar remains always soft. If it evaporates too quickly, the mortar falls to powder, a result which must be in every one’s experience who has witnessed the taking down of old buildings, and the clouds of dust created by the removal of every stone.

Some of the stones from which fat lime is produced contain a proportion of sand as an impurity. They therefore yield an inferior substance. This, though cheaper, is not so economical as pure lime, as it does not increase its volume so much when slaked. The pure or fat lime should only be used for plastering, as it is easily slaked, and therefore not so liable to blister as most hydraulic limes. It expands to double its bulk when slaked, and can be left and reworked again and again without injuring it.

Amongst the great variety of Scotch limes, those of the Hurler and Campsie series have a

reputation which has been handed down for generations. The analysis of the lime from the mines of the Hurler and Campsie Alum Company gives the following proportions:—Carbonate of lime, 91.40; carbonate of magnesia, 3.40; carbonate of iron, 2.07; bi-sulphide of iron, .41; alumina, .60; silica, 1.00; phosphoric acid, .10; coaly matter, .80; water, .10.

Irish rich lime, as used in the West of Scotland for the finishing coat of plaster work, is slaked by immersion, as the Romans are said to have prepared their limes. This "lime putty," prepared by immersion for a longer or shorter period—seldom less than three weeks—before being used, is laid on in a very thin coat, and gives a hard skin to the surface. This hardness is largely, if not wholly, due to the fact that the lime is laid on in a thin layer on the floating coat that has already absorbed carbonic acid from the air. This thin layer becomes harder than the main body of the plaster.

The whole process of preparing lime and laying it on the walls in thin coats, with a considerable space of time between the coatings, is conducive to the ultimate hardness of the whole. The lime is first slaked, and then made into coarse stuff and setting stuff, all this time being exposed to the carbonic acid of the atmosphere. Again, each coat is long exposed to the same influence before being covered with the next, altogether in marked contrast to the system of using the mortar in building.

CALCINATION.—The process of "lime-burning" is carried out in several different ways. But whether the operation be carried out in the simplest manner, or in kilns constructed on the most scientific principles, it will still depend (both as regards the quality and quantity of lime produced) upon the kilnman, as it is only by constant observation from day to day that the man becomes capable of judging whether the proper temperature has been reached, or that a correct opinion can be formed as to the effects produced by the various disturbing causes which exert an important influence upon the working of a kiln, such as its size, shape, the quality of the fuel, and the state of the atmosphere. The kilns vary in size and shape in different districts, though they are generally inverted cones or ellipsoids, into which layers of limestone and fuel are alternately thrown. When worked continuously as running kilns, the lime is periodically withdrawn from below, fresh quantities of fuel and stone being filled in at the top. When lime has not been properly calcined, or "dead burnt," it will not slake with water. This may arise from two causes—from insufficient burning, when the limestone, instead of being entirely caustified, has only been changed into a basic carbonate, consisting of two equivalents of lime and one of carbonic acid, one-half only of its carbonic acid having been expelled. This basic carbonate, on the addition of water, instead of forming a hydrate of lime, and being converted into a fine and impalpable powder, attended with the production of a large amount of heat, is changed, with little elevation of temperature, into a mixture of hydrate and carbonate. In the case of hydraulic limes which contain a considerable amount of silica, this "dead burning" may arise from the limestone having been subjected to a too high temperature, whereby a partial fusion of the silicate of lime formed has been produced, giving an impervious coating to the inner portions of the stone, retarding the further evolution of the carbonic acid. On this account the eminently hydraulic limes require to be carefully calcined at as low a temperature as practicable; and hence it is not infrequently found that Lias lime has been imperfectly calcined. Pure limes, if subjected to an excessive temperature, exhibit somewhat less tendency to combine with water than is the case with lime properly calcined. Caustic lime unites with water with great energy, so much so as to evolve a very considerable amount of heat. When water is poured upon a piece of well-burnt lime heat is rapidly generated, and the lime breaks up with a hissing, crackling noise, the whole mass being converted in a short time into a soft, impalpable powder, known as "slaked lime."

SLAKING. Chemically speaking, slaked lime is *hydrate of lime*—that is, lime chemically combined with a definite amount of water. In the process termed “slaking,” one equivalent or combining proportion of lime unites with one equivalent of water, or in actual weight 28 lbs. of lime combines with 91 lbs. of water (being nearly in the proportion of three to one) to form 37 lbs. of solid hydrate of lime. The water loses its liquid condition, and it is to this solidification of water that the heat developed during the process of slaking is partly due. In England the burnt lime, before it is slaked, is generally called “lump lime,” in Scotland it is called “shells.”

Slaking is a most important part in the process of making coarse stuff and putty lime. Unless the slaking is carefully and thoroughly done, the resultant materials are liable to “blister” or “blow,” owing to small particles still remaining in a caustic state. Blisters may not show until a considerable time has elapsed. There are three methods of slaking “lump lime”—the first by immersion; the second by sprinkling with water; and the third by allowing the lime to slake by absorbing the moisture of the atmosphere. Rich limes are capable of being slaked by immersion, and kept in a plastic state. They gain in strength by being kept under cover or water. Pliny states that the Romans had such great faith in this method that the ancient laws forbade the use of lime unless it had been kept for three years. All rich limes may be slaked by mixing with a sufficient quantity of water, so as to reduce the whole to a thick paste. Lump lime should first be broken into small pieces, placed in layers of about 6 inches thick, and uniformly sprinkled with water through a pipe having a rose on one end, or by means of a large watering-can having also a rose, and covered quickly with sand. It should be left in this state for at least twenty-four hours before being turned over and passed through a riddle. The layer of sand retains the heat developed, and enables the process of slaking to be carried out slowly throughout the mass. Any unslaked lumps may be put into the middle of the next heap to be slaked. The quantity of water should be properly regulated, as if over-watered a useless paste is formed. If a sufficient quantity is not supplied, a dangerous powdering lime is produced. Slaking by sprinkling and covering the lime lumps is frequently done in a very imperfect and partial manner, and portions of the lime continue to slake long after the mortar has been used. Special care must be exercised, and sufficient time must be allowed for the lime to slake when this method is employed.

Different qualities of lime require variable amounts of water; but the medium quantity is about a gallon and a half to every bushel of lime. No water should be added or the mass disturbed after slaking has begun. In most parts of England the lime for making coarse stuff is generally slaked by immersion, and is run into a pit, the sides of which are usually made up with boards, brick work, or sand, the lime being put into a large tub containing water. When the lime is slaked, it is lifted out by means of a pail, and poured through a coarse sieve. It is sometimes made in a large oblong box, having a movable or sliding grating at one end to allow the lime to run out, and also to prevent the sediment from passing through.

In preparing lime for plaster work, the general practice in the North of England is to slake it for three weeks before using. Not only so, but a particular cool lime is selected, for the reason that it is not liable to blister and deface the internal walls when finished. Now, while all this precaution is taken in regard to plastering, in making mortar for building the lime is slaked and made up at once, and it is frequently used within a day or two. But this is not all. Limes which are unsuitable for plaster work, known as hot limes, and which, when plasterers are obliged to use, must be slaked for a period of—not three weeks, but more—nearly three months before using, and are then not quite safe from blistering, are the limes mostly used for building purposes. It will

at once be seen that when mortars of these limes are used immediately, the unslaked particles go on slaking for a long time, drying up the moisture, and leaving only a friable dust in the joints. This should help in understanding the old Roman law which enacted that lime should be slaked for three years before using. If three years should seem to us an absurd time, yet it may be justly said that at least three months are required to slake completely, and to develop fully the qualities of many of the common limes in everyday use. Major-General Gillmore, an eminent American specialist, and a recent writer on the subject of Limes and Cement, mentions that in the South of Europe it is the custom to slake the lime the season before it is to be used.

MORTAR.—This is a term used for various admixtures of lime or cement, with or without sand. For plaster work it is usually composed of slaked lime, mixed with sand and hair, and is termed "coarse stuff," and sometimes "lime and hair," also "lime." In Scotland the coarse stuff is generally obtained by slaking the lump lime (locally termed shells) with a combination of water sprinkling and absorption. The lime is placed in a ring of sand, in the proportion of one of lime to three of sand, and water is then thrown on in sufficient quantities to slake the greater portion. The whole is then covered up with the sand, and allowed to stand for a day; then turned over, and allowed to stand for another day; afterwards it is put through a riddle to free it from lumps, and allowed to stand for six weeks (sometimes more, to further slake by absorption. It is next "soured"—that is, mixed with hair ready for use. Sometimes when soured the stuff is made up in a large heap, and worked up again as required for use. This method makes a sound reliable mortar. In some parts lime slaked as above is mixed with an equal part of run lime. This latter method makes the coarse stuff "fatter," and works freer. All slaked limes have a greater affinity for water than the mechanically ground limes.

Grinding is another process for making mortar or "lime," and if made with any kind of limestone is beneficial. It thoroughly mixes the material, increases the adhesion, adds to the density, and prevents blistering. When there is a mortar-mill, either ground or lump lime can be used, and the coarse stuff may be made in the proportion of 1 part lime and 3 parts sand. The lime should be left in the mill until thoroughly reduced and incorporated, but excessive grinding is detrimental. The process should not be continued more than thirty minutes. Both material and strength is economised if lump lime is slaked before being put in the mill.

When a mortar-mill is used for grinding the lime, the sand may be partly or wholly dispensed with, and excellent results are obtained by using old broken bricks (clean and well burnt), stone chippings, furnace cinders (free from coal, or slag. It is most essential in all cases that the materials used should be perfectly clean. It should be borne in mind that a complete incorporation of the ingredients is essential in the slaking and mixing for coarse stuff, whether done by hand or machine. The sand or other material used can be tested by washing a portion in a basin of clean water, then sifting through a fine sieve. If there is an undue residue of clay, fine dust, or mud in the water or sieve, the whole of the aggregate should be washed or rejected. Lias lime should be mixed dry with sand, and damped down for seven or ten days to ensure slaking. It should not be used fresh for floating or rendering. Pure or rich limes are not so well adapted for outside work, or places exposed to the action of damp, as hydraulic limes. Mortar should be well tempered before using. Pliny states that it was an ancient practice to beat the mortar for a long time with a heavy pestle just before being used, the effect of which would be not only more thoroughly to mix the materials, but to take from the outside of the sand the compound of lime and silica (if such had been formed during the period of seasoning), and by incorporating it with

the mass, dispose it the more rapidly to consolidate. Smeaton found that well-beaten mortar set sooner and became harder than mortar made in the usual way. Mortar made from hydraulic limes should be mixed as rapidly as is compatible with the thorough incorporation of the materials, and used as soon as practicable after mixing, because if put aside for any length of time its setting properties will deteriorate.

Pure limes may be rendered hydraulic by mixing them with calcareous clays or shales, which have been so altered by the agency of heat that the silica they contain has to some extent assumed the nature of soluble silica. In good coarse stuff each granule of sand is coated over with the lime-paste so as to fill the interstices; the lime-paste is to hold the granular substances in a concrete form. If too much lime-paste is present, it is called "too fat"; if the lime-paste is deficient, it is "too lean" or "poor." This can be tested by taking up a portion on a trowel; the "fat" will cling to the trowel, while the "lean" will run off like wet sand. The coarse stuff can be tested by making briquettes, and slowly drying; the good will stand a great pressure, whereas the bad will not—in some cases falling to pieces. Some coarse stuff will appear "fat" on the trowel, but it may be the fatness of *mud*, not the fatness of lime, because sometimes sand is adulterated with fine-screened earth. When this stuff is made in the form of briquettes and dried, it will be extremely friable, and easy to crush; or if put into water until soft, the earthy matter can be seen. Fine-screened earth, when dry and in bulk, does not seem an objectionable material; but in a wet state it is dirt or mud, and should be at once sent off the works. All limes increase in strength by the addition of sand, being the reverse of Portland cement, which is weakened by this addition. Mr Read made four samples of mortar with the proportions of ground lime and sand as follows:—"Ground lime mixed with 4, 6, 8, and 10 parts of clean washed sand to 1 part of ground lime respectively. All set and went hard. One of each was placed in water; that made with 4 parts of sand expanded and went to pieces; those with 6, 8, and 10 parts of sand remained whole, and continued to get harder." The addition of a small proportion of brick dust to mortar will harden and prevent the disintegration of mortar. The proportions are 1 part of brick dust, 2 parts of sand, and 1 part of lime, mixed dry, and tempered in the usual way.

ADHESIVE STRENGTH.—The adhesive strength of mortar varies according to the amount of sand used. The more sand used in the mortar, the less its adhesion. The following table shows the force required to tear apart bricks bedded in mortar made with the usual proportions of sand at the end of twenty-eight days:—

TABLE II.—ADHESIVE STRENGTHS OF LIMES AND CEMENTS.

White Chalk Lime and Sand	1 to 3	4 $\frac{3}{4}$ lbs. per square inch.
Barrow Lias	" "	9 " " "
" " " " " "	(1 to 4)	6 $\frac{3}{4}$ " " "
Portland Cement	1 to 4	23 " " "
" " " " " "	1 to 6	15 $\frac{1}{2}$ " " "

The old mortar which was held in such high esteem by the Romans is said to have consisted of lime mixed with puzzolana or trass. Trass is a material similar in its nature to puzzolana, obtained from extinct volcanoes in the valleys of the Rhine, also in Holland, and is

largely employed in engineering works. The name "trass" is derived from a Dutch word meaning a binding substance. Much has been written and said about the ancient and the old Roman mortars, but it may be safely said that, from the year one up to the present time, no cement or mortar has the strength, or could excel, or stand our variable climate as well as Portland cement. The primary cause of the premature decay which takes place in stuccos and cements, when used externally as a coating to walls, is the presence of muddy earth and decayed animal and vegetable matter in the sand used in the lime and cement. To this may be added the frequent impurities in the limes and cement themselves. The impurities in the sand may be eradicated by thorough washing, and the lime should be carefully selected, prepared, and manipulated. John Smeaton used a mortar made of blue Lias from Aberthaw, and of puzzolana brought from Civita Vecchia, near Rome, in the construction of the Eddystone Lighthouse. If it were to be built at the present time, the cementing material would certainly be Portland cement. Having now briefly reviewed the principal parts and processes of mortar, the practical conclusions to be drawn are, that the quality of the lime is of as great importance as the quantity, and thorough slaking is imperative; that the proportions of sand may vary considerably, and that it should be coarse and irregular in size, and of a clean and hard nature.

THE HARDENING OF MORTAR.—According to the results obtained from tests and experience, the hardening of mortar is due to several causes acting collectively. These causes appear to be absorption of carbonic acid from the atmosphere, and the combination of part of the water with the lime which act upon the sand, dissolve and unite with some of the silica of which the sand is composed, thus forming a calcium silicate (silicate of lime). Some authorities state that the silicate of lime is formed by the reaction of lime and silicate of mortar, and to this is due the hardness of old mortar. In mortar made from pure lime, the initial setting is due to the evaporation of the water, and to the production of minute crystals of hydrate of lime, which slowly absorbs carbonic gas from the air, the rapidity of this absorption necessarily decreasing in proportion to the difficulties presented to the free access of air. The setting and hardening of hydraulic limes are due mainly to crystallisation brought about by the action of water on the silicate of lime, and not by mere absorption of carbonic gas from the atmosphere, as is the case in fat limes.

The Romans were convinced that it was owing to prolonged and thorough slaking that their works became so hard, and were not defaced by cracks. Alberti mentions that he once discovered in an old trough some lime which had been left there five hundred years, as he was led to believe by many indications around it, and that the lime was as soft and as fit to be used as if it had been recently made. Common mortar made of rich lime hardens very slowly, and only by the evaporation of the water of the mixture, and by the absorption of carbonic acid from the atmosphere, with which it forms a crystalline carbonate of lime. This process, however, is so slow, that it gave rise to the French proverb quoted by Pasley that "Lime at a hundred years old is still a baby"; and there is a similar proverb among Scotch masons, "When a hundred years are past and gane, then gude mortar turns into stane." Mortar from the interior of the Pyramids, where it has been exposed to the action of the air, still contains free lime although it is five thousand years old. It has been ascertained that in rich lime mortars the carbonic acid penetrates about one-tenth of an inch into the joint in the first year, forming a skin or film which opposes the further absorption of carbonic acid, except at a decreasing ratio, so that the lime remains soft for an indefinite period.

In illustration of this several cases have been cited, amongst others one by General Treussart, who in the year 1822 had occasion to remove one of the bastions erected by Vauban in 1666. After these 156 years the lime in the interior was found to be quite soft. Dr John, of Berlin, mentions

that in removing a pillar of 9 feet diameter in the Church of St Peter, Berlin, eighty years after erection, the mortar was found to be quite soft in the interior.

General Pasley mentions several instances at Dover Harbour, and at Chatham dockyard, the latter in particular, when part of the old wharf wall was pulled down in the winter of 1834. The workmen were obliged to blast the brickwork fronting the river, which had been built with Roman cement, but the backing, done with common lime mortar, was in a state of pulp; the lime used had been prepared from pure limestone or chalk. But it is not necessary to go so far back for knowledge of the absence of the setting quality in the rich limes, as there have been frequent experiences of it in the present age. While these remarks are true of the richer limes, many of our limes are comparatively poor in carbonate, and associated with silica, alumina, magnesia, and oxide of iron, which may either be partially combined in the natural state, or enter into combination with the lime during the process of calcination, and these limes might be termed slightly hydraulic.

M. Landrin, who submitted to the French Academy the results of some experiments on the hydraulicity and hardening of cements and limes, came to the conclusion that 1) silicates of lime raised to high temperature set with difficulty, and in any case do not harden in water; 2) for the calcination of cements to exert a maximum influence on the setting, in connection with water of the compound obtained, the process must be carried sufficiently far for the limes to act on the silica so as to transform it into hydraulic, and not into fused silica; and 3) carbonic acid is an indispensable factor in the setting of siliceous cements, inasmuch as it is this substance which ultimately brings about their hardening. The comparative strengths of various mortars are shown in the following table:

TABLE III.

Comparative Strength of Grey Lime and Portland Cement Mortar, also Portland Cement Mortar with the addition of Lime and Mortar. REIDGRAVE

N.	No. of Tests	PORTLANDS.				Breaking Strain on 2,25 square inch in Pos.	Breaking Weight per square inch in lbs.	Ratio as compared with Lime Mortar.	Ratio as compared with Cement Mortar.	REMARKS.
		Sand.	Cement.	Lime.	Water.					
1	17	2,00	...	1,00	1,33	61,06	27,13	Three samples.
2	27	2,00	...	1,00	1,33	105,07	47,09	Grey lime.
3	27	2,00	...	1,00	1,33	82,00	36,44	Water includes that required for slaking lime.
1	15	6,00	1,00	...	1,25	233,53	103,79	2,81 to 1	...	Cement taken from bulk in store.
2	20	8,00	1,00	...	1,66	154,80	68,80	1,86 to 1	...	
3	35	10,00	1,00	...	2,00	112,88	50,16	1,36 to 1	...	
1	70	6,00	1,00	0,50	1,50	165,31	73,47	2,00 to 1	0,70 to 1	Water includes that required for slaking lime.
2	74	8,00	1,00	0,66	2,00	132,72	58,94	1,60 to 1	0,85 to 1	
3	75	10,00	1,00	0,83	2,50	95,27	42,34	1,14 to 1	0,84 to 1	
				Loam.						
1	21	6,00	1,00	0,50	1,00	136,80	60,80	1,64 to 1	0,58 to 1	Yellow loam, fresh dug, and rather damp.
2	25	8,00	1,00	0,66	1,33	86,48	38,43	1,04 to 1	0,55 to 1	
3	19	10,00	1,00	0,83	2,00	64,50	28,66	0,77 to 1	0,57 to 1	

MAGNESIA IN MORTARS.—Magnesia plays an important part in the "setting" of hydraulic limes as well as in Portland cement. Vicat, after many experiments, was led to recommend magnesia as a suitable ingredient of mortars to be immersed in the sea, stating that if it could be obtained at a cost that would admit its application to such purposes, the problem of making concrete unalterable by sea-water would be solved. General Gillmore, speaking of the American lime and cement deposits, says: "Magnesia plays an important part in the 'setting' of mortars, derived from the argillo-magnesian limestones such as those which furnish the Rosendale cements. The magnesia, like the lime, appears in the form of a carbonate. During calcination, the carbonic acid is driven off, leaving protoxide of magnesia, which comports itself like lime in the presence of silica and alumina, by forming silicate of magnesia and aluminate of magnesia. These compounds become hydrated in the presence of water, and are pronounced by both Vicat and Chatoney to furnish gangues, which resist the dissolving action of sea-water better than the silicate and aluminate of lime. This statement is doubtless correct, for we know that all of these compounds, whether in air or water, absorb carbonic acid, and pass to the condition of subcarbonates, and that the carbonate of lime is more soluble in water holding carbonic acid, and certain organic acids of the soil in solution, than the carbonate of magnesia. At all events, whatever may be the cause of the superiority, it is pretty well established by experience that the cements derived from argillo-magnesian limestones furnish a durable cement for construction in the sea."

In Marshal Vaillant's report to the French Academy of Sciences, from the Commission to which Chatoney and Rivot's paper was referred in 1856, this superiority of the magnesian hydrates is distinctly asserted. A few years ago the French Government Office of Civil Engineers made a series of comparative tests on three samples each of French, English, and German cement, in which the results are given in favour of the German cement, which contained magnesia to the extent of 2.4 per cent., against 0.26 in the English and 0.32 in the French, and summed up thus: "A great value is to be placed on the presence of magnesia, and the excellence of the German cement is partly due to the higher percentage of magnesia contained in it." Gillmore further says that magnesian limestone furnishes nearly all the hydraulic cement manufactured in the western part of the State of New York. At East Vienna it has been used for cement, and at Akron, Erie Co., N.Y., a manufactory of some extent is in operation. Vicat says: "Having analysed several old mortars, with the view of discovering, if possible, to what their superior durability might be attributed, I found, in some excellent specimens of very old mortar, magnesia to exist in considerable proportion." The limestones, therefore, from which these mortars were prepared must have contained the silica and magnesia as constituent ingredients; and it is to be remembered that it is the presence of these substances which communicates the property of hardening under water. Professor Scorgie says of carbonate of magnesia: "Magnesium carbonate is a substance very similar to carbonate of lime; it loses its carbonic acid in burning, combines with silica, &c., and behaves generally in the same way; it does not slake, however, on being wetted, but combines with the water gradually, and quietly sets to some extent in doing so. Magnesium carbonate, combined with lime, reduces the energy of the slaking, and increases that of the 'setting' processes; when other substances are present, its behaviour and combination with them are similar to those of lime. When carbonate of magnesia is present in sufficient quantity, say about 30 per cent., it renders lime hydraulic independently of and in the absence of clay." Colonel Pasley also, by experiments, demonstrated that magnesian limestones are suitable for hydraulic mortars.

The foregoing assertions that magnesium carbonate, combined with lime, reduces the energy of the slaking and increases that of the "setting" processes are satisfactory and conclusive. Many

such evidences showing the value of magnesia in hydraulic mortars might be quoted, but perhaps these are sufficient.

EFFECTS OF SALT AND FROST IN MORTARS.—Few experiments have as yet been made to test the general effects of salt in mortars, though as a preventive of the effects of frost it has been tried with varying results.

In some German experiments, designed to ascertain the effect of frost upon hydraulic limes and cement gauged with and without the addition of salt to the water, cubes of stones were joined together with cement mixed with water ranging from pure rain water to water containing from 2 to 8 per cent. of salt. Before the cement was set, the blocks were exposed in air at a temperature varying from 20 to 32 degrees Fahr., after which they were kept for seven days in a warm room. At the end of this time the samples were examined. The cement made with water was quite crumbled, and had lost all its tenacity. The cement made with water containing 2 per cent. was in better condition, but could not be described as good; while that containing 8 per cent. of salt had not suffered from its exposure to the lowest temperature available for the purpose of experiment. It is suggested as possible that the effect of the salt was merely to prevent the water in which it was dissolved freezing at the temperature named, and so permitted the cement to set in the ordinary way. But it must be allowed that in practice, salt dissolved in the water for mixing mortar has been successfully used to resist the effect of frost. A solution of salt applied to new plastered walls in the event of a sudden frost will protect the work from injury. The addition of a small portion of sugar will improve its adhesion, and increase the frost-resisting powers.

Salt takes up the vapours from the atmosphere, causing the work to show efflorescence, and in some instances to flake, especially in external work. That some engineers believe there is virtue in salt water is beyond doubt, because salt water has been named in their specifications for the gauging of concrete. Salt in Portland cement seems to act somewhat differently; as regards efflorescence it shows more in this material than in lime mortar. Salt should not be used in Portland cement work that has to be subsequently painted. According to the results of tests of mortar used for the exterior brick facing of the Forth Bridge piers below water they show a good average tensile strength. One part of Portland cement and one part of sand were slightly ground together in a mill with salt water, and briquettes made from this gauge gave an average of 365 lbs. per square inch at one week, and 510 lbs. at five weeks after gauging. It would be interesting to note the condition of this mortar a century hence, time being the trying test for all mortars.

A solution of commercial glycerine mixed with the setting stuff, or used as a wash on newly finished lime plaster work, is a good preventive of the evil effects of frost. Glycerine solution may also be used for the same purpose on new concrete paving. Strong sugar water mixed with coarse stuff has some power in resisting frost. The quantity depends upon the class of lime, but the average is about 8 lbs. of sugar to 1 cubic yard of coarse stuff or setting stuff. The sugar must be dissolved in hot water, and the stuff used as stiff as possible.

SUGAR WITH CEMENT. Sugar or other saccharine matter mixed with cement has been tried with varying success. It is well known that saccharine is used with mortars in India. According to some experiments made in America the results obtained were that the addition of sugar or molasses delayed the setting of the mortar, the retardation being greater when molasses were used. When certain proportions were not exceeded, the strength of the mixture was that of the pure cement. Less than 2 per cent. of sugar must be added to Portland cement, and less than 1 per cent. to Roman, otherwise the mortar will not hold together. The sugar appears to have no chemical action on the other materials, crystals of it being easily detected on the broken surfaces,

the increased binding power of the cement brought about by the addition of sugar being due more to mechanical than chemical causes. In my own experiments with sugar added to Portland cement for casting deep undercut ornament figures and animals out of gelatine moulds, the results at first were very irregular, some casts attaining great hardness, while others crumbled to pieces. The time of setting also varied considerably. Three different brands of cement were used, and it was found that the cement containing the most lime required more sugar than the lowest limed cement, but the average is about 1½ per cent. of added sugar. The sugar must be dissolved in the water used for gauging. The setting and ultimate hardness is also influenced by the atmosphere. The casts should be kept in a dry place until set and dry, before exposing them to damp or wet. Portland cement has a tendency (especially if over limed, to "fur" gelatine moulds, but the sugared cement left the moulds quite clean.

In experiments by Austrian plasterers, mixtures of 1 part of cement and 3 parts sand, and 10 per cent. of water, and of pure cement with as much water as was necessary to give the mass plasticity, were prepared. From 1 to 5 per cent. of powdered sugar was well mixed with the dry cement. The cement used was of inferior quality, the sand being ordinary building sand, and not the so-called "normal" sand, which is of a superior quality. They were left to harden in a dry place, and not under water. For each series of samples made with sugar a comparative series without sugar were prepared, all the samples being made by the same man, under the same conditions, and with the same care. The tenacity was ascertained by Kraft's cement-testing machine. The strength was far below that prescribed and generally obtained. It should be mentioned that the samples with sugar especially those of pure cement showed a strong tendency during the first twenty-four hours to combine intimately with the smooth china plate on which they were placed to swell, and the results of the trials showed that with mixtures of cement and sand, and by hardening in a dry place, the binding effect may be increased by the addition of sugar, which reached its maximum with from 3 to 4 per cent. of sugar added. With pure cement the binding effect was not much increased. I think if the sugar used for gauging had been dissolved, and not mixed dry, the results would have proved better.

SUGAR IN MORTAR.—Most writers have supposed that the "old Roman mortars" contained strong ale, wort, or other saccharine matter, and it is probable that the use of sugar with lime passed from India to Egypt and Rome, and that malt or other saccharine matter was used in their mortars. The addition of sugar to water enables it to take up about 14 times more lime than water by itself. The following is an extract from the Koorkee: "It is common in this country to mix a small quantity of the coarsest sugar, 'goor,' or 'jaghery,' as it is termed in India, with the water used for mixing up mortar. Where fat limes alone can be produced, their bad qualities may in some degree be corrected by it, as its influence is very great in the first solidification of mortar. This is attributed to the fact that mortars made of shell lime have stood the action of the weather for centuries owing to this mixture of 'jaghery' in their composition. Experiments were made on bricks joined together by mortar, consisting of 1 part of common shell lime to 1½ of sand; 1 lb. of 'jaghery' being mixed with each gallon of water. The bricks were left for thirteen hours, and after that time the average breaking weight of the joints in twenty trials was 6½ lbs. per square inch. In twenty-one specimens joined with the same mortar, but without the 'jaghery,' the breaking weight was 4½ lbs. per square inch."

The Madras plasterers make most beautiful plaster work, almost like enamelled tiles, the shell lime being mixed with "jaghery." The surface takes a fine polish, and is as hard as marble, but it requires a good deal of patient manipulation.

Dr Compton has made some experiments with sugar gauged with cements and mortars, and says: "That in medicine there are two kinds of lime water, one the common lime water that can be got by mixing lime and water, and it is particularly noted that, add as much lime as you like, it is impossible to get water to dissolve more than half a grain of lime in one ounce, or about two small teaspoonfuls of water. But by adding 2 parts of white sugar to 1 part of lime, there is a solution obtained which contains about $14\frac{1}{2}$ times more lime in the same quantity of water. Here it is to be observed—and it is a most important point—that there are hot limes, such as Buxton, which, if they be incautiously mixed with them, will burn the sugar, make it a deep brown colour, and convert it into other chemical forms, and possibly destroy its value in mortar."

The "jaghery" sugar used in India is sold in the London market at about a penny a pound. Treacle seems to be the most promising form of saccharine matter; beetroot sugar is not good for limes or cements. There is a rough unrefined treacle which is very cheap, and it is supposed would have an excellent effect.

Herzfeld states that he used coarse stuff, consisting of 1 part of lime to 3 of sand, to which about 2 per cent. of sugar had been added, to plaster some walls in the new buildings of the Berlin Natural History Museum, and on the day following he found the lime plaster had hardened as if gauged with plaster. He also found it useful in joining bricks, and recommends the coarse stuff to be fresh made, and not with a great proportion of water; and states that good molasses will yield as good results as sugar.

LIME PUTTY.—This material is prepared in a similar way to run lime intended for coarse stuff. It is run through a finer sieve into a box or pit. If the latter is used, the interior should be plastered with coarse stuff to prevent leakage, and keep the putty clean. For good work, the best class of lump lime should be used. The putty should be allowed to stand for at least three months before it is used. For common work, the lump lime, for making coarse stuff, putty, and setting stuff, is often run into one pit. The putty at the end farthest from the sieve, being the finest, is retained for putty and for making setting stuff; and the remainder, or coarser portion, being used for coarse stuff. In many instances the putty is left for months in an unprotected state, during the progress of the building, which is wrong. It may be kept for an indefinite time without injury if protected from the atmosphere, and therefore it should be covered up to resist the action of the air, as it absorbs the carbonic acid gas, and thus becomes slightly carbonated, and loses to a certain extent its causticity, and consequently its binding and hardening properties.

Pliny states that the old Roman limes were kept in covered pits. If a small portion is taken off the top of the putty, it will be found not only dry, but scaly, short, and inert; whereas a portion taken from the middle, or up to the part carbonated, will be found to be of an oily and tenacious nature. A cute plasterer always selects the putty farthest from the sieve for mitring purposes, as it is the finest.

SETTING STUFF.—This material is composed of lime putty and washed fine sharp sand. The proportion of sand varies according to the class of lime and kind of work, but the average is 3 parts of sand to 1 of putty. The various proportions are given where required for the different works. Setting stuff is used for finishing coat of lime plastering. It is generally made on a platform of scaffold boards, and sometimes in a bin. The putty and sand are thoroughly mixed together by aid of a larry. The sand should be sized by washing it through a sieve, having a mesh of the desired size. In some districts it is made by pressing or beating the putty and sand through a "punching sieve" into a tub. Setting stuff is less liable to shrink and crack, and

is improved generally, if it is allowed to stand after being made until nearly hard, but not dry, and then "knocked up" to the required consistency with water (preferably lime water), and the aid of a shovel and larry. While the stuff is firming by evaporation, it should be covered up to protect it from dust and atmospheric influences. It should be used as soon as "knocked up." Setting stuff may be coloured to any desired tint, and also mixed with various ingredients to obtain a brilliant and marble-like surface. (See "Coloured Setting" and "Stuccos.")

HAired PUTTY SETTING.—Haired putty was formerly used to a very considerable extent as a setting coat in districts where the local lime was of a strong or hydraulic nature, not very readily manipulated when mixed with sand, as used for setting stuff. This material is composed of fine lime putty and well-beaten white hair. The hair was thoroughly mixed with the putty to toughen and prevent it from cracking. To such an extent was hair added, that in some instances the setting coat, when broken, had the appearance of white felt. This class of setting stuff is now seldom used, owing to the railway facilities for obtaining more suitable lime for the purpose. Mr J. Welling, a prominent plasterer of Shrewsbury, who occasionally uses this material, informs me that during some alterations at Cound Hall, erected about a century ago, he stripped from the floating a piece of haired putty setting about 4 feet by 2 feet, and $\frac{1}{4}$ inch thick, which admitted of being rolled up like a piece of felt, and with but little injury to it. This example proves the toughness and flexibility of haired putty setting, but also shows an apparent want of adhesiveness or tenacity, or it could not be stripped in such a large section. This is probably due to a lack of knowledge on the part of the plasterer as to the nature of the material or the manipulation of the same. It may also have been caused by an evil of almost everyday occurrence, viz., the unkeying of the floating, and laying the setting coat on a dry absorptive surface. The numerous instances where haired putty setting is inseparable from the floating go to prove its adhesiveness.

LIME WATER.—This water has many medicinal virtues, and is a simple and inexpensive remedy for cuts and bruises. Plasterers are generally healthy and free from many infectious diseases. This may be partly owing to their almost constant contact with lime. Lime water, used as a wash, will harden plaster casts. It is also used when scouring and trowelling setting stuff to harden the surface.

HAIR.—Hair is used in coarse stuff as a binding medium, and gives more cohesion and tenacity. It is usually ox-hair (sometimes adulterated with the short hair of horses). Good hair should be long, strong, and free from grease or other impurities. In England it is generally obtained from plasterers'-hair merchants in a dry state in bags or bundles. This dry hair should be well beaten with two laths to break up the lumps; as, unless the lumps are thoroughly broken so as to separate the hair, they are only a waste, and worse than no hair at all, since the lumps have no binding power, and will cause a soft weak spot in the plaster when laid. Many failures of ceilings have been caused by the hair not being properly beaten and mixed. Human hair is sometimes used for jerry work. Goats' hair is often chosen in America. Hair in Scotland is usually obtained direct from the tanners' yard, fresh, and in a wet state. This makes the best work, as it is much stronger, and mixes freely. Hair should never be mixed with hot lime, and with no mortars, until nearly ready for using, because wet or hot lime weakens the hair, more especially if dry. Coarse stuff for first coating on lath work requires more hair than for brick or stone work. When coarse stuff is made in a mill, the hair should not be added until the stuff is ground, as excessive grinding injures it.

FIBROUS SUBSTITUTES FOR HAIR.—Manilla fibre, as a substitute for hair in plaster work, has been the subject of experiments in America. One of the most conclusive of these tests was

made by four briquettes or plates of equal size: one containing manilla hemp, a second sisal hemp, a third jute, and a fourth of goats' hair of the best quality. The ends of the plates were supported, and weights suspended from the middle. The result showed that plaster mixed with goats' hair broke at 144½ lbs. weight, the jute at 145 lbs., the sisal at 150, and the manilla at 195—in the latter case, the hemp not breaking, but cracking, and though cracked in the centre, the lower half of this plate, when it was suspended, held on to the upper half, the manilla securing it fast. The three other plates were broken—that is, the two parts of each plate had severed entirely. Another experiment consisted in mixing two barrells of mortar, each containing equal portions by measure of sharp sand and lime, one of the barrells, however, being mixed with a proper quantity by measure of manilla hemp, cut in lengths of 1½ to 2 inches, and the other of best goats' hair. On being thoroughly mixed with the usual quantity of water, the respective compounds were put in the barrells and stored away in a dry cellar, remaining unopened for nine months. On examination, the hair mortar crumbled and broke apart, very little of the hair being visible, showing that the hair had been consumed by the action of the lime; but the other, containing the hemp, showed great cohesion. It required quite an effort to pull it apart, the hemp fibre permeating the mass and showing little or no evidence of any injury done to it by the lime.

SAWDUST AS A SUBSTITUTE FOR HAIR.—Sawdust has been used as a substitute for hair, also for sand in mortar for wall plastering. It makes a cheap additional aggregate for coarse stuff. Sawdust mortar stands the effects of rough weather and frost when used for external plastering. The sawdust should be used dry, and put through a coarse sieve to exclude large particles. I have used it with plaster for both run and cast work; it proved useful for breaks of heavy cornices, by rendering the work strong and light for handling. Some kinds require soaking or washing, otherwise they are liable to stain the plaster. Several patents have been issued in America for the use of sawdust in place of hair and of sand. One of these is for the use of equal parts of plaster or lime and sawdust; another is for the use of 4½ parts each slaked lime and sawdust to 1 part of plaster, ¼ part of glue, and ¼ part of glycerine, with a small part of hair. Kahl's patent plaster consists of 35 per cent. of sawdust, 35 per cent. of sand, 10 per cent. of plaster, 10 per cent. of glue, and 10 per cent. of whiting.

SAND.—Sand is the most widely distributed substance in nature, not only in the mineral, but also in the animal and vegetable kingdoms. Clay contains no silica (the chemical name for sand). Sand is the siliceous particles of rocks containing quartz, produced by the action of rain, wind, wave, and frost. Some kinds of sand are also found inland; the deposits mark the sites of ancient beaches or river beds. Sand is classed under various heads, viz., calcareous, argillaceous, and metallic. Sand varies in colour according to the metallic oxides contained in them. Few substances are of more importance than sand for plastic purposes. Its quality is of primary importance for the production of good coarse stuff, setting stuff, and for gauging with Portland or other cements used for plaster work. Its function is to induce the mortar or cement to shrink uniformly during the process of setting, hardening, or drying, irregular shrinkage being the general cause of cracking. Sand is also a factor in solidity and hardness; while being of itself cheaper, and used in a larger proportion than lime or cement, it decreases the general cost of materials. There are three kinds—pit, river, and sea sands. They generally contain more or less impurities, such as loam, clay, earth, and salts, necessitating their being well washed in water, more especially for the finishing coats of plaster or cement work. Pit sand is sometimes found quite clean; it is generally sharp and angular. River sand is fine grained, not so sharp as pit sand, but makes good setting stuff. Sea sand varies in

sharpness and size, and for plastering it should be washed, to free it from saline particles which cause efflorescence.

Regarding the use of sand in mortars, it may almost be spoken of as a necessary evil. Sand is necessary to give body and hardness to an otherwise too soft and plastic material, and the coarser and cleaner the better, as the coarse particles allow the carbonic acid to penetrate farther into the body of the mortar, and assist in the hardening process for this reason. In the case of cements of all kinds sand is only good for lessening the cost of the aggregate, and in the case of the majority of sands in daily use in most places the strength is reduced out of all proportion to the saving effected. Brunel, in making the Thames Tunnel, was so convinced of this that he used pure Portland cement in the arches; and General Pasley, treating of this, recommends that only pure cement should be used on all arduous works.

As to the quality of sands, they are of very wide variety—so much so, that 1 part of an inferior or soft clayey sand will reduce the strength of mortar as much as 3 or 4 parts of clean sharp, granitic sand. This is well exemplified in the sand test, which is made with what is called standard sand, being a pure silicious sand sifted through a sieve of 400 holes to the square inch, and retained on one of 900.

Good sand for lime plaster should be hard, sharp, gritty, and free from all organic matter. For coarse stuff and cement for floating coats it should not be too fine. Good sand for plaster work may be rubbed between the hands without soiling them. The presence of salt in sand and water is found not to impair the ultimate strength of most mortars; nevertheless it causes an efflorescence of white frothy blotches on plaster surfaces. It also renders the mortar liable to retain moisture.

Fine-grained sand is best for hydraulic lime; the coarse-grained is best for fat limes, and coarse stuff and Portland cements for floating. Sand should not be uniform in size, but, like the aggregate for concrete, should vary in size and form. A composition of fine and coarse sand for coarse stuff, unless the sand is naturally so mixed, gives the best results; for as the lime will receive more sand in that way without losing its plasticity, it will make a harder and stronger material, whether coarse stuff, setting stuff, or for Portland cement work. If there is plenty of fine sand and a scarcity of coarse sand, they should be mixed in the proportion of 2 of coarse to 1 of fine. If, on the other hand, there is plenty of coarse sand and a scarcity of fine, they should be mixed in the proportion of 2 of fine to 1 of coarse. The proportion of sand varies according to the different kinds and qualities of limes and cements, also purposes, and is given under the various heads. Barytes is sometimes used as a substitute for sand. Silver sand is used for Portland cement work when a light colour and a fine texture is required. Silver sand is chiefly obtained at Leighton Buzzard. Arnold's silver sand is extensively used in London for cement work and sgraffito. Tests of sand, &c., are given in Chapter XVIII.

MASTIC.—Mastic was formerly extensively used for various purposes in which now Portland cement is chiefly employed. It is still used in Scotland and the North of England for pointing the joint between the wood frames of windows and the stone work. Mastic is waterproof, heat-resisting, and adheres to stone, brick, metal, and glass with great tenacity. Mastic is made in various ways. Some plasterers make their own.

SCOTCH MASTIC is composed of 14 parts of white or yellow sandstone, 3 parts of whiting, and 1 part of litharge. These are mixed on a hot plate to expel any moisture, and then sifted to exclude any coarse particles. It is then gauged with raw and boiled linseed oil, in the proportion of 2 of raw to 1 of boiled oil. The sandstone is pounded or ground to a fine powdered state before being mixed. The surface to be covered is first brushed with linseed oil.

LONDON MASTIC is prepared as follows:—100 parts of ground stone, 50 parts silver sand or of fine river sand, and 15 parts of litharge. These are all dried and mixed, and passed through a fine sieve; it then resembles fine sand. This mastic may be kept for any length of time in a dry place. When required for use, it is gauged with raw and boiled linseed oil (in equal proportions) until of the consistency of fine stuff. It requires long and frequent beating and kneading; in fact, the more it is knocked up the better it works. Its fitness for use can be ascertained by smoothing a portion of the gauge with a trowel. If there are any separate parts of the different materials or bright spots seen, the knocking-up must be renewed until it is of even texture. The addition of 15 parts of red lead is sometimes used to increase the tenacity of the mastic.

MASTIC MANIPULATION.—The walls are prepared for mastic by raking out the joints and sweeping with a coarse broom, and the brick work well saturated with linseed oil. Narrow screeds about 1 inch wide are formed in plaster to act as guides for floating the work plumb and level. When laying the mastic, it must be firmly pressed on, and the floating rule carefully passed over the surface until it is straight and flush. The screeds are next cut out, and the spaces filled in with extra stiff mastic. The whole surface is then finished with a beech or sycamore hand float, leaving a close and uniform texture. Mastic mouldings are first roughed out with Medina or other quick-setting cement. The running mould is muffled, so as to allow $\frac{1}{4}$ inch for the mastic coat.

HAMELLIN'S MASTIC.—This mastic consists of sand and pulverised stone, china, pottery, scharff, to which are added different oxides of lead, as litharge, grey oxide, and minium, all reduced to powder, to which again is added pulverised glass or flint stone, the whole being intimately incorporated with linseed oil. The proportions of the ingredients are as follows:—To any given weight of sand, or pulverised pottery ware, add two-thirds of the weight of pulverised Portland, Bath, or any other stone of the same nature. Then to every 550 lbs. of this mixture, add 40 lbs. of litharge, 2 lbs. of pulverised glass or flint stones, 1 lb. of minium, and 2 lbs. of grey oxide of lead. The whole must be thoroughly mixed together and sifted through a sieve, the fineness of which will depend on the different purposes for which the mastic is intended. The method of using is as follows:—To every 30 lbs. of the mastic add 1 quart of linseed oil, and well mix together, either by kneading or with a trowel. As it soon begins to set, no more should be mixed at a time than is requisite for present use. Walls or other surfaces to be plastered with this material must first be brushed with linseed oil.

MASTIC CEMENT.—Mix 60 parts of slaked lime, 35 parts of fine sand, and 3 parts of litharge, and knead them to a stiff mass with 7 to 10 parts of old linseed oil. The whole mass must be well beaten and incorporated until thoroughly plastic. This mastic cement assumes a fine smooth surface by trowelling. It is impervious to damp, and is not affected by atmospheric changes.

STEARATE OF LIME.—This lime is often used in America as a finishing coat to resist damp. It is made by mixing 1 bushel of lime with 20 lbs. of finely chopped suet, and adding boiling water until the ingredients are thoroughly mixed and about the consistency of lime putty. The lime and suet are placed in a barrel, then the boiling water is poured on, and the whole worked together by a revolving shaft, having arms at its lower end somewhat similar to a "pug-mill", until the mass is thoroughly incorporated. Stearate may be applied hot with a brush, two coats generally being sufficient. The suet undergoes a chemical change when mixed with the lime, and forms a compound impervious to water, and as durable as paint. It makes an excellent paint for stone, brick, or concrete. It can be made to assume any tint by the addition of stains.

CHAPTER III.

MATERIALS—Continued.

MANUFACTURE, ANALYSIS TESTS, COMPRESSIVE, TENSILE, AND ADHESIVE STRENGTHS AND USES OF CEMENTS—PORTLAND, SLAG, WILKES AND MILLAR'S METALLIC, ROMAN, SHEPPEY, MEDINA, KLEN'S, HOWE'S, PARIAN, ROBINSON'S, ADAMANT, BASSETT'S, ASBESTIC, STONE, AND PARIS CEMENTS—MANUFACTURE AND USES OF SELENITIC—HYDRAULIC CEMENTS AND PLASTERS—GRANITE, SIRAPITE, SHALE, PETRURA, AND AMERICAN PATENT PLASTERS—BLACK FINISH—LATHING—WOOD, REED, SLATE, WIRE, AND METAL LATHING—EXPANDED METAL, JHILMI, BOSTWICK, JOHNSON'S, HAY'S, PATENT METAL SHEET LATHING, AND HELICAL METAL LATHING.

CEMENTS.—The earliest known patent for cement was obtained in 1677 by Kendricks Edisbury, for "a certaine sort of Plaister of an Extraordinary Hardness called 'Glassis' which may be used instead of Freestone for paving of Floors and Water Mills for grinding corn." There is a long specification in legal phrase about protecting the inventor and his exhibition, &c., but not a word about the materials or process; because at that time inventors were not bound to disclose their process and method of manufacture. Cements are composed of finely ground lime or other substances, which are used alone or mixed with other materials, so that they will set on the addition of water. They are usually divided into natural and artificial cements. Roman cement, plaster of Paris, and similar cements are natural cements; Portland cement, slag, and similar cements are artificial cements.

PORTLAND CEMENT.—Portland cement was patented by Joseph Aspdin, a bricklayer and plasterer of Leeds, in 1824. His son, William Aspdin, was one of the earliest makers of Portland cement, having a manufactory at Wakefield. He afterwards associated himself with Messrs Maude, Son, & Co., and in 1843 started a manufactory at Rotherhithe, on the banks of the Thames. Aspdin also obtained a patent in 1825 for a concrete of lime, road scrapings, &c., for artificial stone. In 1852 his son William obtained a patent for an improved method of manufacture of Portland cement. Portland cement is obtained by a careful combination of three well-known minerals, viz., carbonate of lime, alumina, and silica. This combination can be arrived at by the admixture of various materials, and even from waste products, such as the slag from iron districts and alkali waste from the soda and other cognate manufactures. But the materials from which it is generally made are chalk and clay or mud. Its advantages over all other cements are—its hydraulic properties, great strength at comparatively early dates, its continually increasing strength, and its power of carrying very large proportions of sand or other aggregate when made into mortar or concrete. The process of manufacture may be divided as follows:—(1) Getting the chalk and clay; (2) mixing the chalk and clay in certain proportions, and producing slurry; (3) drying the slurry; (4) burning the dried slurry called "slip"; (5) crushing the clinker; (6) grinding the crushed clinker; and (7) producing the finished cement. In the process of mixing or washing, the chalk and mud—in the proportion of about 3 to 1 when mud is used, and 4 to 1 when using clay—are tipped into the wash-

mill. This consists of a circular brick pit sunk into the ground, in the centre of which revolves a vertical shaft carrying four or more horizontal arms, from which depend harrows, the tines of which in their course break the lumps, and keep the whole mass in a violent state of agitation. Water is used as required until a stiff paste is formed. When it is in a sufficient state of pulverisation it passes through a grating and falls into a pit, from which it is carried by an elevator into a tank at a considerable height from the ground.

The exact proportions of the chalk and clay cannot be definitely fixed, as the material may vary in composition in different parts of the quarry or pit, and in wet weather may have absorbed a quantity of water before reaching the wash-mill, the amount of which cannot be arrived at by mechanical means. To get at this proportion, some manufacturers burn off a small sample kiln daily, convert it into cement, and apply the usual tests for tensile strain, soundness, &c. ; but as the result of this experiment is not arrived at until too late to rectify the evil, if any, it is of little value except for future guidance, and perhaps the advantage (if the result is obtained in time, and is unsatisfactory) of being able to prevent the cement to which the sample belonged being bulked in the warehouse with good qualities.

A quicker and altogether more satisfactory test is obtained by an apparatus called a calcimeter. In this operation a fixed quantity of hydrochloric acid, and a given quantity of "slurry" taken from the wash-mill and thoroughly dried (the quantity varying slightly with the variations of barometer and thermometer), are put together in a sealed vessel, one end of which is connected by a pipe with a U-shaped glass tube partly filled with water. The carbonic acid gas generated by the mixture of the acid with the carbonate of lime depresses the water in the leg of the column to which it is attached, and it having been decided by experience to what extent this depression should occur in order to make good cement, it will be seen that too great a depression means too much carbonate of lime, or, in other words, too much chalk, and *vice versa*.

From the tank the slurry descends to the wet-mill, and is ground between burr-stones to ensure the perfect reduction of the coarse particles; or it is run through centrifugal separating sieves, the coarser particles, which will not pass through the meshes, returning to the wash-mill pit to be further agitated and reduced. From the stones it falls by gravitation into a sump, from whence it is pumped in a semi-fluid state on to fire-tiled floors, under which are arranged flues taking the heat from furnaces placed at one end. When perfectly dry the slurry is broken with a crowbar into lumps of, say, 6-inch cube, and carried to the kilns, which are loaded with alternate layers of coke and the dried slurry, now called "slip." Faggots are placed at the bottom of the kiln to start the fire, and the kilns take about five days to burn off. After allowing a few hours to cool, the fire-bars are taken out, and the contents withdrawn in the form of "clinker." This is a hard, lava-like substance, of considerable specific gravity, and may be compared to the "pig" of the iron furnace. It is wheeled away and passed through a crushing-machine, which breaks it into cubes of, say, 1½ inches. These are carried by an elevator into a hopper over the grinding or dry mill, which is fitted with burr or emery stones, edge runners, or some form of disintegrator, which reduce it to a fine powder. The powder is elevated to the level of a horizontal worm, which conveys it to the warehouse, and when air-slaked it is ready for use.

The kilns used in connection with the fire-tiled floors are called bottle-kilns from their shape; but in order to save the expense of the fuel used in drying the slurry, they are giving way to kilns in which the heat, while "turning off," passes under and over a horizontal chamber on which is pumped the slurry for the next charge, thereby drying it in readiness to reload the kiln.

The colour of cement should be a deep grey. It is conceded by the best authorities that a

weight of 112 lbs. per bushel gives satisfactory results. It should have a specific gravity of about 3.10. This is the better test of its proper calcination, as the weight per bushel varies according to the grinding. The finer the grinding, the less the weight, while the specific gravity of course remains the same. The weight test is the most useless of all.

The colour when gauged and dry should be of a light grey. A brown or foxy colour denotes an over-clayed or unburnt cement. Different brands of Portland cement may be equally good in strength and durability, yet differ slightly in composition when analysed. The following is an analysis of two different brands of Portland cement. The first is by H. Faija, of a Portland cement made on the Thames. The second is by A. E. Carey, of a Portland cement made at Stockton, near Rugby:—

TABLE IV.—ANALYSIS OF PORTLAND CEMENT.

	Lime.	Silica.	Alumina.	Oxide of Iron.	Sulphuric Acid	Soda and Potash.	Other Ingredients, Loss, &c.
No. 1 - - -	61.76	20.54	9.90	2.04	0.71	2.13	2.92
No. 2 - - -	61.5	22.22	10.10	3.19	0.85	1.34	1.25

Great care should be exercised in the selection of Portland cement, and it is safer to deal with manufacturers of good repute. Some manufacturers mix Kentish rag and other stones, furnace ashes, disused or exhausted fire-bricks, or other inert material, thus bringing disrepute upon the good name English cement has hitherto borne in comparison as to quality with cement of foreign manufacture, and entailing unsound and unsatisfactory work at home.

Having now detailed the process of manufacture, the chief qualities of Portland cement may be enumerated as follows:—(1) Setting and hardening properties; (2) consistency of volume; (3) permanence in water and air; (4) strength under tension and compression; (5) impermeability by water; (6) resistance to wear; (7) resistance to fire; (8) adhesion to brick and stone.

BRIQUETTES.—Briquettes are small blocks of gauged cement or other material, which are used to test the tensile strength of the material by drawing them apart by means of a machine. Various forms and sizes of briquettes have been used. The earliest kinds were 1½ inches, 2 inches, and 2½ inches square at the waist, or smallest part where the fracture would occur, but they are now generally made 1 inch square at the waist. This size is more convenient, and can be tested with less powerful machines.

Briquettes allowed to harden in the air absorb carbonic acid gas from the atmosphere to the extent of about 6 per cent. in the first six months, while cement immersed in water remains free from it. The briquettes kept in water, and therefore free from carbonic acid gas, offer about twice as much resistance to compression than the others. Between the ages of one and six months briquettes made with quick-setting cement give lower results than they would for slow-setting. A briquette of neat cement is more brittle than one of concrete. The maximum strength of a briquette of matured cement is maintained, while one of new cement "goes back."

WATER FOR BRIQUETTES.—The quantity of water should always be the same when making briquettes, and the results with the same cement will then be more uniform. All other things being equal, a cement that will not take up its full quantity of water, 10 to 25 per cent. of its weight, is not so good as one that does. Briquettes gauged with 20 oz. of water to 100 of cement

will give better tensile results than those gauged with 30 oz. of water to 100 of cement. The former gauge is rather dry or stiff, and it must be carefully rammed into the moulds. A good cement, not too old, will expand in setting, and completely fill up the space allotted to it, whereas an old cement will not do so, and consequently spaces are left for water to enter and weaken it. The water should be perfectly clean and cold. When hot water is used for special purposes, the temperature should be noted for future reference.

Gauging for Briquettes.—The gauging of the mortar for briquettes for testing should be done upon glass, porcelain, slate, or other non-absorbent surface. It must be done thoroughly, rapidly, and in a constant temperature between 60 and 70 Fahr. For Portland cements use 1 part cement and 3 parts sand, and for natural cements 1 part cement and 1 part sand. The proportions are by weight. Mix thoroughly, and then add sufficient water to give the mass the consistency of damp sand. To obtain good results, as little water should be used as possible, the actual amount depending upon the quality of both the sand and cement, and also the proportions in which they are used. There is little danger of using too little water, only 20 to 25 per cent. being required for neat cement, 15 per cent. for 1 part of sand, and 10 to 12 per cent. for 3 parts of sand. These percentages are in proportion to the combined weight of the cement and sand. In preparing a quantity of cement for neat or sand briquettes, this mixture should be thoroughly kneaded by hand, and afterwards trowelled until perfectly homogeneous. For neat tests, the cement should be worked until it sheds water, and with sand until all the grains are covered.

When the sand and cement are thoroughly incorporated, the mortar is pressed into oiled moulds, with sufficient pressure to exclude all air bubbles and make the briquettes compact and uniform. After filling, the moulds should be smoothed off on both sides with a trowel, and laid away under a damp cloth for twenty-four hours, when the briquettes should be removed from the moulds and immersed in water of 65 or 70 Fahr., care being taken that they are completely submerged. In making briquettes by hand, it is usual to mix only sufficient mortar to make five tests. With a larger quantity there is danger of an incipient set, and the necessity of reworking the mortar. The evils attending this operation are well understood, and it is for this reason that several machines have been designed by the use of which briquettes are not only made much faster, but ensure a much greater uniformity, the variation being reduced to about 2 per cent. To make five briquettes of standard size of the neat cements requires about $1\frac{2}{3}$ lbs. of material; and for those containing 1 part of cement to 3 of sand, about 6 oz. of cement and $1\frac{1}{4}$ lbs. of sand.

SIEVING.—In tests for fineness of Portland cement three sieves are used—No. 50 sieve, 2,500 meshes to the square inch, made of No. 35 wire, Stubs' wire gauge; No. 74 sieve, 5,476 meshes to the square inch, made of No. 37 wire; and No. 100 sieve, 10,000 meshes to the square inch, made of No. 40 wire. A weighed amount of cement is taken and sieved with the No. 50 sieve. What passes through is carefully weighed, and its percentage of the original amount calculated. A similar amount of cement is taken and tested on the No. 74 sieve, and similarly on the No. 100 sieve, the percentage passing through being calculated. These measurements are made on a small scale weighing to 0.0001 lb. For comparative tests, briquettes should be made with cement that has passed through a No. 100 sieve, but for a particular piece of work the cement should be used as it comes in the bag or barrel. When tests are made to determine the value of a cement for any particular piece of work, the sand used should be the same as is to be used in the work; but for comparative tests it is necessary to use a standard sand that can readily be duplicated. For this purpose crushed quartz is used, the degree of fineness being such as to pass a No. 20 sieve and be caught on a No. 30 sieve.

TESTING MACHINES.—There are several kinds of machines for ascertaining the tensile strength. Among them may be mentioned those of Adie, Bailey, Studt Michele, Kuhlmann, and Faija. Cement-testing machines are all nearly constructed on the same principle.

The aim in the construction of Adie's machines was absolute permanence and non-interference of the hand of the operator. Thus all springs and screws were dispensed with, and the simple steel beam and weight travelling on rollers adopted, that pulled by a light cord, which need not be fixed to the weight, the hand can thus only affect the forked pillar, which does not touch the beam in testing. To make this more unquestionable, in addition to the speed-reducing wheel and pinion a patent automatic regulator can be added. The subjoined illustration (No. 12) shows the automatic speed regulator. This carries the weight uniformly, at a certain speed, on the beam, so as to be quite independent of the hand of the operator, a very necessary improvement. If the standard A be not in its place when received from the manufacturer, bolt it down to the stand, so that the beam when strained (by putting a moulded brick of cement into the clips B and C, and then tightening by means of a wheel underneath at D) may take its position freely in the centre of fork E. Wind the cord once round the pulley at A, and twice round that at E. Mix the cement to be tested with as little water as possible, consistent with perfect homogeneity, and having laid the mould on a flat surface, or on the iron plate supplied for the purpose, fill it with the cement as described, and scrape the top flush. When set, take the briquette out of the mould

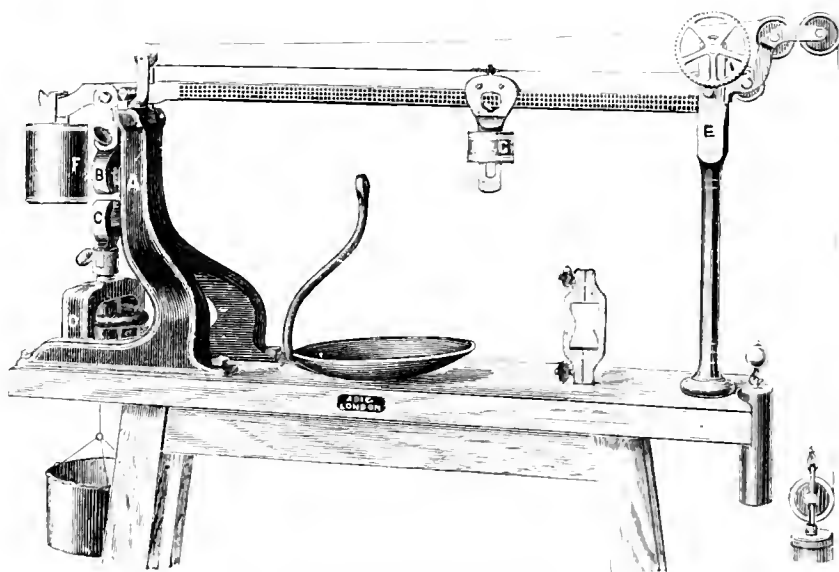

NO. 12. — CEMENT-TESTING MACHINE.

carefully. This is done by releasing some screws simultaneously, thus releasing the sides, and place it on the flat plate in water for seven days; it will then be ready for testing. To effect this, place it in the clips, turn the wheel at D till they clasp the brick with sufficient force to raise the end of the beam nearly up to the pulley above. H is the elevation of the briquette mould. The scale pan on the bench of the testing machine is used for weighing small quantities of cement, or indeed anything, as the machine acts as an ordinary weighing machine. The pan suspended beneath the bench will contain one-tenth of a bushel of cement, that quantity being most convenient to weigh. *a.* For strains from 0 to 130 lbs., using the bottom row of figures, hang the transferable weight F in the notch at the end of the beam (as shown in the drawing) and roll the vernier weight G along, taking about one minute to travel the length of the beam. *b.* From 90 to 200 lbs., using the middle row of figures, remove F from the machine, and roll G forward as before. *c.* Above 150 lbs., using the top row of figures, hang on F in the notch under G, and roll G (carrying F with it) forward as before. To use as a weighing machine, remove the sliding block carrying D and C; take out the

top clip B, and hang on the scale pan instead. A hook passing through a hole in the stand can be supplied with one-tenth bushel measure to weigh the cement if required.

An excellent and accurate cement tester Kuhlmann's patent is manufactured by Messrs G. Salter & Co. This machine is used by many of the principal cement manufacturers and contractors in England and abroad.

THE NEEDLE TEST. The rapidity with which a cement loses its plasticity shows its initial hydraulic activity. Cements that set in less than half an hour are termed quick setting, and those requiring a longer period slow setting. Quick-setting cements should not be worked longer than a minute, or slow-setting longer than three minutes. As soon as the cement has assumed sufficient hardness to bear the gentle pressure of the finger nail, it is considered as beginning to set. The time of setting is usually measured by the penetration of a steel point, termed "The Needle Test." This test was first used in this country by General Q. A. Gillmore, and consists of a $\frac{1}{2}$ -inch wire loaded with $\frac{1}{4}$ lb., and a $\frac{3}{4}$ -inch wire loaded with 1 lb. Pats are made of neat cement about $2\frac{1}{2}$ inches in diameter, $\frac{1}{2}$ inch thick in the centre, and $\frac{1}{4}$ inch thick at the edges. For the initial set, the time is recorded from when they are made to the time when they will support the $\frac{1}{4}$ -lb. weight without making an impression, and the final set until they will support the 1-lb. weight. If the pats will not bear the $\frac{1}{4}$ -lb. weight after five hours the cement should be rejected.

CHECKING TEST.—The test for checking or cracking is frequently used. Make two pats of neat cement, same as for the setting test, and note the time it takes to set hard enough to bear the $\frac{1}{4}$ -lb. and 1-lb. loads. When hard enough, one of these cakes should be placed in water and examined from day to day to see if there are any indications of contortions or cracks. The other pat should be kept in the air and its colour observed, which, for a good cement, should be free from blotches.

BOILING TEST.—Make a briquette or thin cake of neat cement as above, allow it to set hard in the air with a damp cloth over it for twenty-four hours, then immerse in boiling water and boil for twenty-four hours. This boiling causes the coarse grain to disintegrate, and if there is an excess of free lime in the cement, the caustic lime, becoming hydrated, swells and causes the cake to crack. This cracking and disintegrating is called "blowing," and any cement acting this way should be rejected. Care must be taken, however, not to confuse the fine hair lines found on the surface which cross and recross each other with the coarser wedge-shaped cracks due to swelling or blowing, for the fine lines are merely the result of slight changes in temperature and do not denote a poor cement. This test should be used in conjunction with the sand test and test for fineness to determine accurately the quality of the cement.

TENSILE TEST.—The test for tensile strength is the most common of all tests, though not a perfect indication of the value of a cement. It is frequently the only test used in comparisons of different kinds, but the results obtained from neat cements do not give uniform conclusions regarding the binding properties of the cement and sand. In comparing several varieties of cement, it is necessary to use a high percentage of sand, as the setting properties of different varieties vary much with the amount of sand. A proportion (by weight) of 1 part cement to 3 of sand is taken as the standard for Portland cements, and equal parts of sand and cement for natural cements.

After the briquette has attained the requisite age, it is placed in the testing machine and subjected to a strain of 400 lbs. per minute until fractured. In adjusting the clips to the specimen the greatest care must be exercised that everything comes to a full and even bearing, as carelessness in this respect leads to a greater variation in results than from any other cause. Briquettes for tensile tests are left one day in air and one day in water, or one day in air and six days in water, or one

day in air and twenty-seven days in water. These three are the usual tests, though the briquettes are sometimes allowed to remain in water as long as a year.

The tensile strain of Portland cement is generally specified at from 350 to 400 lbs. in the square inch for neat cement seven days old, the briquette to be immersed in water twenty-four hours after being made. The strain should be applied at a speed of 100 lbs. per fifteen seconds. Briquettes should also be made with a mixture of 1 part of cement to 3 of clean sharp sand, and immersed in water twenty-four hours after being gauged. They should stand a strain of 250 lbs. per square inch seven days after gauging. The grains of sand should be of uniform size, and only those portions should be employed which have passed through a sieve 900 meshes per square inch, and been retained by one 1,600 meshes to the square inch. The value of a cement is best determined by the strength of a mixture of cement and sand (1 to 3 tested at twenty-eight days), and not by the strength of the cement alone, because practically cement is never used alone in actual work, but generally with sand or some other aggregate. Sand varies greatly in hardness and strength, therefore the sand used for the test should be of the kind which would be used for the actual work. This would give a knowledge of the strength to which the intended work might be expected to attain. When ascertaining the strength of Portland cement the average of not less than three tests should be taken. Portland cement is weakened by the addition of sand or other aggregate. At the end of one year after setting—

1	of sand and 1	of cement is about	$\frac{3}{4}$	the strength of neat cement.
2	1	"	$\frac{1}{2}$	" "
3	1	"	$\frac{1}{3}$	" "
4	1	"	$\frac{1}{4}$	" "
5	1	"	$\frac{1}{6}$	" "

The strain a hand-made briquette will stand depends in a great measure upon the skill of the manipulator, as it is evident that any one accustomed to the work will be able to gauge with less water and in less time than a novice. To be able to form a true opinion of the value of cement, briquettes should be tested when practicable at twenty-eight days, as well as at seven, as the greater the increase between these dates, the stronger the cement is likely to become. The deduction which has been arrived at by a series of tests of tensile strength is that the quick-setting cements and those which acquire great strength in a short time do not as a rule continue to increase in strength after a few months, and that after they have attained their ultimate strength they have a tendency to fall off. Some manufacturers guarantee a strength of 450 lbs. per square inch at the age of seven days. Some cements have given a tensile strength of 700 lbs. at seven days, but as they show little increase of strength afterwards, they most likely contain too much lime, and are therefore somewhat unsafe. Provided a cement is sound and sufficiently fine, it will bear a tensile strain of 350 lbs. per square inch at the age of seven days. It may be accepted for nearly all kinds of work.

COMPRESSIVE STRENGTH.—Testing by compression is useful to indicate the stress the concrete will bear in certain parts of a building, such as arches. The briquettes should be composed of the same kind and proportions of materials as intended for the actual work. The compressive resistance of briquettes composed of 1 part of Portland cement to 3 of sand varies from 8 to 12 times greater than tensile strength. Mr Faija found, from the average of three tests of 1-inch cubes made from four cements, that at the age of twenty-eight days the resistance to crushing varied from 4,270 lbs. to 4,780 lbs., and the resistance to tension from 480 lbs. to 696 lbs. Better results are obtained if larger cubes and bedded with plaster are used for testing, as the slightest inequality of surface may cause fracture under a comparatively small stress.

TRANSVERSE STRENGTH.—Portland cement may be sound, but only of moderate strength. It is therefore necessary to test the strength, and in the absence of a testing machine the following method, as specified by Mr D. A. Stevenson, may be adopted:—"The cement is to be made into blocks 1 inch square and 8 inches long; these are to be immersed in water for seven days, and then tested by being placed on two supports 6 inches apart, when they must stand the transverse strain produced by a weight of 75 lbs. placed on the centre." This is a simple way of testing. Several briquettes should be tested to ascertain their average strength.

FINENESS.—The test of fineness is the most important and valuable. Most specifications agree on the point of fineness, which is generally that when sifted through a sieve having 2,500 holes (50 by 50) to the square inch it should leave a residue of not more than 10 per cent. by weight, and that when sifted through a sieve with 625 holes (25 by 25) it shall leave practically nothing. Manufacturers should sift all Portland cement to a standard degree of fineness. The residue or coarser parts retained on the sieves could be reground. The finer cement is ground, the greater its adhesive strength, and the more sand it will carry. Finely ground cement only has any cementitious value, the coarse particles being worthless, as they resist the action of water and cause "blowing." This is caused by the coarse particles not being acted upon until after the finer portions have set, the subsequent chemical union of the coarser parts and the water expanding and damaging the cement which has already set. There is less need for storing and air-slaking cement before using it if it has been ground very fine. In the early days of Portland cement a sieve having 40 meshes to the lineal inch was used, subsequently one with 50 to the lineal inch (2,500 per square inch), and at the present time one with 75 to the lineal inch (5,625 per square inch) is used to test the cement by sifting. German cement is ground much finer than English, and Austrian still more so, a sieve of 900 meshes being used (5,806 per square inch), not more than 10 per cent. supposed to be retained on the sieve after sifting. If a cement which has all passed through a No. 40 sieve be sifted through a No. 75, the particles remaining on the latter will be absolutely valueless as a cementitious agent.

SOUNDNESS.—Testing Portland cement by the preliminary tests of colour, weight, and fineness, or what tensile strength is developed within the period of an ordinary test, is of little value if the cement proves unsound, or in the course of time will "blow." The test of "soundness," or absence of expansion or contraction, is the most important. Mr H. Faija has devised a test which is at once quick and decisive. The method is to submit a freshly made pat of cement to a moist atmosphere of about 100° Fahrenheit, and when set hard to immerse it for some hours in water at a temperature of 115° Fahrenheit. This treatment greatly expedites the setting and hardening of cement, and in a like manner develops any blowing tendency which may exist in it, and consequently in the short space of twenty-four hours the soundness or unsoundness of a cement may be absolutely determined. In the absence of a testing machine, certain tests can be applied to show the soundness of cement. For instance, if a thin glass bottle is filled with stiff-gauged neat cement, and after it has been set a few days the bottle is found to be cracked, it shows it has either been manufactured with an excess of lime, is not air-slaked, or the disintegration of the raw materials are not sufficiently perfect, in which case free lime will assert itself. White spots in the latter case can be detected with a magnifying glass. If the expansion is due to an excess of lime, the cement must be looked upon as dangerous. If, on the other hand, the cement contracts, it is either overclayed or underburnt, and will be a quick-setting and weak cement. The contraction in the bottle is best shown by pouring a little coloured water into it. Pats are also made to test the soundness and colour of the cement, being immersed in water like the briquettes.

If after a time they show flaws or cracks on their edges, the cement should be looked upon with suspicion; but as the cracks do not in some cases occur for several weeks after immersion, this test is impracticable when the cement is required for immediate use.

EXPANSION.—The expansion and contraction of Portland cement due to temperature is greater than that caused by mere hardening. Mr Grant gives the following inferences:— 1 All cements expand more or less when hardening in water; 2 The expansion of good cement is so slight that in practice it need hardly be taken into consideration; 3 It is greatest when the increase of strength is most active; 4 It diminishes in proportion to the addition of sand; 5 It is greatest with new cements, and least with that which has been kept in stock; (6) It is increased by the addition of gypsum; (7) It is greatest with over-limed or lightly burnt cements, and that all cements contract when drying and expand on being put into water.

ADHESION.—A number of experiments for testing the adhesive strength of Portland cement carried out by Mr Mann showed that the adhesive strength did not bear a uniform relation to the tensile or cohesive strength, but varied from about 1 to 5 to 1 to 9 in the 7 days' tests, and from 1 to 3 to 1 to 5 in the 28 days' tests, the adhesive strength increasing more rapidly than the cohesive in the 21 days which elapsed between the two tests. The average adhesive strength of neat Portland cement is about 80 lbs. and 90 lbs. per square inch at 28 days. The tests in the first series of experiments were made by tearing apart small pieces of sawn close-grained limestone which had been joined with cement, and the second series with cement bedded between pieces of sawn close-grained limestone.

AIR-SLAKING.—Air-slaking and cooling plays an important part in the ultimate success of Portland cement when used for plastering purposes, especially for façades. There is a consensus of opinion among manufacturers and users, on the imperative necessity of dealing with the free lime, and rendering it innocuous by air-slaking, previous to using the cement. The presence of free lime can be detected by emptying the contents of a sack on a floor, and after a few days' exposure closely examining it. It will then be found fissured all over with seams and cracks, showing unmistakably the disruptive effects.

The following description of a process whereby the free lime in Portland cement is rendered entirely innocuous, is an extract from a paper on "Limes and Cement," by Mr A. M'ARA, of Glasgow: "The cement is first hoisted to an upper floor of the store, the sacks emptied, and contents bulked, after which the cement is gradually fed into a receiver, from which it is made to fall down a cylinder or trunk, where, by a particular arrangement, it is caught at frequent intervals on a series of perforated shelves, constructed in a special manner, so as to thoroughly open up the body of the cement and delay its passage, while all the time a constant blast of cold air is directed upon every particle from a perforated pipe through which a current of cold air is forced by a fan driven by steam-power. The cement is subjected to this aërating process during the whole time of its passage from the receiver until it falls on the floor, where it is allowed to lie for some time in this aërated condition to ensure the full effect of the process. The process of maturing is much facilitated by the addition of a small percentage of finely pulverised carbonate of lime, and a decided improvement effected thereby, the carbonate having a marked influence in the 'setting' of free lime, which it is proved exists more or less in all Portland cements."

The ground carbonate contains always a certain amount of moisture in which a proportion of the carbonate and bicarbonate of lime exist in the soluble state. The extreme avidity of the free lime for water causes it immediately to absorb this moisture, and in doing so it slakes, thereby losing its power for evil; and not only so, but becoming to a slight extent hydraulic by the absorption

of carbonic acid from the bicarbonate in solution. I am also inclined to think that when water is added in making up mortar or concrete, a further absorption of carbonic acid occurs, aided by the heat which, to some extent, accompanies the process of slaking. That some action of this sort occurs is perfectly certain, otherwise the addition of a percentage of carbonate of lime would weaken the cement exactly in the same way as so much sand added; but after a long series of careful experiments on the cements of many manufactures, I have found the very reverse to be the fact, and instead of any weakening, there is a perceptible gain in strength. Having found these effects from the application of carbonate to Portland cement, I searched some of the recognised authorities on limes and cements, and found much to confirm me in the adoption of the process. Burnell says: "Broken limestone appears to add very much to the qualities of concrete betons and mortars. Very probably this may be attributed to the affinity between the molecules of the already formed carbonate of lime and that which is in process of formation. The new crystals may group themselves more easily about bodies whose form is similar to the one they are themselves to assume, or possibly there may be a tendency in the chemical elements to arrive at a state of equilibrium, and the carbonate of lime may therefore be supposed to part with a certain portion of its carbonic acid." Burnell also mentions a discovery by a Mr Westmacott, which formed the subject of a patent:—With a view to augmenting the resistance of the rendering coats of plaster that are executed in lime, by the admixture of pounded limestone with that material. This is in fact nothing more than the application of the principle mentioned in the text where the tendency of the lime to crystallise around a gangue of the same nature as itself is referred to, and the inference is drawn that the presentation of the crystallised form of carbonate of lime would be favourable to the solidification of the mass of concrete betons or mortars.

It is to be observed that Mr Westmacott mixes with the chalk lime that he employs considerable quantities of pounded chalk, or of some equally common description of stone that has a base of carbonate of lime, and thus he obtains a mixture that is capable of setting with greater rapidity. Vicat says: "To obtain mortars or cements capable of acquiring great hardness in the open air, and to resist rain and heat, we must combine amongst other things) the powers of hard calcareous minerals;" and he also shows experiments with calcareous and granite sands, which are in favour of the former. Henry Reid, C.E., says: "When in a moist state, lime would probably dissolve a portion of any calcareous aggregate." Major-General Gillmore gives various experiments to show that underburnt stones possess superior hydraulicity, and contain carbonic acid; and that overburnt stones, from which the carbonic acid is driven off, are less or more deprived of "setting" power. Tomlinson says: "A very intimate mixture of quicklime and carbonate of lime has feeble hydraulic properties; and limestone gently heated, so that a large proportion of it remains in the form of carbonate, slightly hydraulic. In the burning of rich limes, imperfectly burned fragments are always found which have this character, and it appears to be due to the formation of a definite compound of carbonate of lime and hydrate of lime." "Portland cement is different from all other hydraulic limes and cements, in respect that the high temperature required in the kilns to effect the chemical combination of the lime with the silica and alumina, drives off nearly, though not quite, all the carbonic acid gas, and any particles of lime remaining uncombined, as is always the case to some extent, have been deprived of all hydraulic or 'setting' properties, and remain in the cement as so much quicklime; whereas, in all natural cements and hydraulic limes, there is left, after calcination, carbonic acid to the extent of from 6 to 8 per cent."

In the analysis of the famous hydraulic lime of Theil, in France, carbonic acid is present to the extent of about 8 per cent. I would further call attention to the fact, demonstrated by

analysis, that when cement is laid out to air-slake by the method usually adopted on large contracts, it increases in weight by the absorption of carbonic acid and moisture in the proportion of two-thirds of the former to one of the latter. This is the same result as is effected by my process, with this difference, that by my system the cement is acted upon equally throughout, while by the usual method it is only the exposed surfaces that are properly purged of the free lime, unless where frequently turned over at great cost. Other authorities might be quoted, but perhaps enough have been given for our purpose, and they go far to show that my air-slaking process, with the addition of carbonate, is based on sound principles, and fitted to grapple with, and overcome, an acknowledged difficulty and danger in the use of Portland cement.

The practice of aerating or air-slaking cement is only done to remedy as far as possible the results of careless or imperfect manufacture. Aeration is unnecessary for a perfectly burnt and mixed cement, but in the present imperfect method of manufacturing it is advisable that it be adopted. To avoid the very common danger of swelling and blowing, it is usual in well-regulated firms of contractors and plasterers to open the cement bags when delivered on the works, and to empty their contents on to a dry wood floor and leave the contents exposed from seven to twenty-one days. The process is further hastened by frequently turning the cement up with a long rake to allow the air to reach the cement at the bottom. The cement on the floor should not be more than one foot deep. The dry cement swells under this treatment from the hydration of the particles of caustic lime. Care should be taken that no damp gets at the cement, and that the air-slaking is not too long. The cement can be tested by gauging a portion and putting it in a glass bottle. If in expanding it does not burst the bottle, it is fit for use. Portland cement should be used before it is six months old, after that period it begins to deteriorate in strength and setting powers. If it is protected from atmospheric influences, it will keep better and longer.

MAGNESIA IN PORTLAND CEMENT.—Magnesia in Portland cement has a curious effect, especially if the proportion is high. It acts as an inert substance while the rest of the cement sets. After a time the magnesia begins to hydrate, and sets very hard; but this process is attended with a considerable augmentation of volume, which destroys the structure in which the phenomenon occurs.

The following opinions of several authorities on the use of magnesia, soda, and salts in combination with Portland cement, as used in one of my patents, is taken from a series of articles on "Artificial Stones," which appeared in *The Builder*:—"Wilkes and Millar's decorative fibrous metallic compound, patented in 1885, is formed of a mixture of powdered slag, brick-dust, pumice, slag-wool, and Portland cement, moistened in solution of chloride of magnesium or bitterne water, carbonates of soda, and ammonia and caustic soda. The caustic soda and carbonate would cause the formation of a portion of hydrate and carbonate of magnesium, which, uniting with undecomposed chloride, would form the desired oxychloride. The addition here of an ammonium salt seems at first sight of doubtful utility, as such compounds tend to prevent the precipitation of magnesium compounds, yet it may in virtue of this very property be useful in preventing the too rapid setting of the mixture, and owing to its volatile character, its expulsion, and the removal of its retarding influence, would only be a matter of time and temperature. To impart strength and flexibility to the compound, the inventors mould it on wire or perforated metal work, or incorporate it with tow. In some cases the soluble silicate and chloride of calcium treatment is applied, and the stone finally washed with a solution of bichromate of potash. Erdmenger states that magnesia calcined at a low temperature possesses the property when added to Portland cement of rendering the latter more durable and better able to withstand the influence of the salts of sea-water. The

temperature of calcination has an important practical bearing upon this matter, for M. Lechartier has pointed out that magnesia calcined at a high temperature has a most evil effect upon the durability of Portland cement, in consequence of its peculiar property, first noticed by St Clair Deville, of uniting with water to form a hard hydrate, an increase of volume at the same time taking place. This hydration, in the case of over-calcined magnesia, only takes place after a prolonged contact with water, so that in some cases investigated by Lechartier the cement having been made from dolomitic marl, and which seemed to set very hard, and to be in all respects most satisfactory, in a year or two disruption of the cement and destruction of buildings in which it had been employed showed the practical effect of a neglect of Deville's observation. The indurating effect of ammonium salts is disputed by some, but they are nevertheless used by several patentees in artificial stone."

MAGNESIA CEMENT.—A new method of treating magnesia has been recently invented. It was formerly merely calcined and made up with water. Now the calcined magnesia is carefully slaked, and is subsequently exposed to the action of carbonic acid gas, much in the same way that plasterers have been in the habit of drying and hardening newly plastered rooms by burning coke in the closed rooms so as to liberate carbonic acid gas. The new substance is used as a cementing agent, and when mixed with marble dust an artificial dolomite is obtained.

EFFECTS OF AGE ON CEMENT.—Practical experiments fully determine the effects of age on Portland cement in a dry state. The cement gradually absorbs moisture and carbonic acid from the atmosphere, and chemical changes occur in it analogous to those which take place when it is gauged for use. The longer the cement is kept, the greater will be the extent of these changes, and consequently the greater the extent of the deterioration. Ultimately a cement may become quite useless. A certain amount of air-slaking, however, is necessary and beneficial to some qualities of Portland cement. These latter, especially when under-burnt, very frequently contain an excess of free caustic lime, which causes the cement to swell very considerably if used immediately after being made. This swelling causes the work to blow, and otherwise spoils it.

TO SET QUICK.—Various materials and methods have been used to hasten the setting of Portland cement, more especially for cast work and for paving. A common method for cast work is to place the newly filled moulds before a fire. This should never be done, as the heat abstracts the moisture which is necessary for the proper setting of the material, thus causing the work to become more or less friable. Dry heat will dry the cement, but that is a very different thing from causing it to set. Moist heat may be used advantageously; it hastens the setting and also the hardening of cement. Urine is sometimes used to hasten the setting, but besides being offensive, it is liable to cause an efflorescence to arise on the surface. Warm water has also been used for a similar purpose, but the effects are often disappointing, unless special care is taken to regulate the temperature. When used for jelly moulds it acts disastrously. Soda dissolved in water, and then mixed with the gauging water, is also frequently used to hasten the setting of Portland cement casts. Soda quickly obtains the desired effect, but in many instances it causes the work to blow and crack. These evils may be partly corrected by first heating or roasting the soda on a hot plate before dissolving in hot water, and then allowing the solution to thoroughly cool, and afterwards passing it through a very fine-meshed sieve or a muslin bag to free it from sediment. It is then mixed with the gauging water, and regulated precisely in the same way as used for size water and plaster, and then exposing the solution to the air for not less than three months before using it. Portland cement mixed with a solution of calcium chloride rapidly acquires great hardness. Setting begins in three or four minutes, and is attended with a rise of temperature that may attain

158 Fahrenheit. Cement mixed with calcium softens if immediately put in water, but after being air-dried for eight or ten days may be immersed without detriment to its cohesion and hardness. Ordinary damp air has no influence upon the mixture. When great hardness and quick setting is required, the cement may be used neat, but for general purposes cement and sharp sand in equal proportions may be used.

INFLUENCE OF LIGHT ON PORTLAND CEMENT.—The influence of light on cement has been proved by dividing a quantity of newly made cement into 3 parts, exposing part A to the air and full light, B to the air and diffused light, C in darkness and excluded from the air. After six months A made a weak mortar by absorbing 38½ per cent. of its weight of water, and was crumbly. B with 33½ per cent. of water made a mortar which was too adhesive to the trowel, and it did not yield any of its water. C with 33½ per cent. of water made an excellent mortar, easily gauged, and it relinquished some of its water. After setting for twenty-eight days the relative strengths were—A, 3; B, 37.9; C, 44.6. These tests prove that cement should be covered over with boards, or kept in bags until required for use.

INCREASE IN STRENGTH AFTER BEING GAUGED.—Portland cement increases in strength after having been gauged. The following table, compiled from experiments made by Mr Grant in 1865, will show the increase. The test blocks were 2¼ inches square at the neck, and were kept in water from the time of making to the time of testing.

TABLE V.—INCREASE IN STRENGTH OF PORTLAND CEMENT AFTER BEING GAUGED.

Age.	Neat Cement.	1 of Cement to 1 of Sand.
	Average Breaking Test of 10 Experiments.	Average Breaking Test of 10 Experiments.
7 days.	817 lbs.	353 lbs.
3 months.	1,055 ..	547 ..
6 ..	1,170 ..	640 ..
9 ..	1,219 ..	692 ..
12 ..	1,229 ..	716 ..
2 years	1,324 ..	790 ..
4 ..	1,312 ..	818 ..
6 ..	1,308 ..	819 ..
7 ..	1,327 ..	863 ..

These tests show that neat cement gradually increases in strength for two years, but that after the second year the increase is somewhat less. Cement with sand appears, however, to have continued to increase for seven years.

FIRE-RESISTING PROPERTIES.—It is often claimed that plaster resists the influence of fire more than any other cement, but from experiments made to ascertain its fire-resisting properties it has no advantage over good Portland cement.

Mr H. Lockwood made several blocks of concrete, some consisting of plaster and broken

retorts ($\frac{1}{2}$), and others of Portland cement and burnt shale $\frac{1}{4}$. At the age of six weeks they were subjected to intense heat for 1 hour and 45 minutes, after which they were plunged into water for 8 minutes, and when taken out those made of gypsum were completely disintegrated, while it took considerable force applied with a sledge-hammer to break those composed of Portland cement.

The following table from *The Builder* shows the results of experiments carried out by Mr J. G. Webster to ascertain the fire-resisting properties of various kinds of concrete:—

TABLE VI. SUMMARY OF TESTS AS TO THE FIRE-RESISTING PROPERTIES OF VARIOUS CONCRETES.

No.	Materials in Concrete Bricks.	Proportions of Ingredients.	Average Weight per cubic foot.	Breaking Weight per square inch.		Average Loss per cent. of Original Strength after Heating and Quenching.
				At Temp. of 600 Fahr.	After being Heated and Quenched.	
1	Portland cement	Neat	124.6	554.6	117.2	78.8
2	" " and sand	1 to 1	120.9	448	93	79.2
3	" " " "	1 " 3	111.2	100.8	18.7	81.4
4	" " " "	1 " 5	109.7	74.6	15	79.8
5	" " iron furnace slag	1 " 4	163.08	108.1	23.06	78.6
6	" " fire-brick	1 " 4	95.04	84.4	30.5	63.8
7	" " pumice-stone	1 " 4	64.8	94.6	38.3	59.5
8	" " coke-breeze	1 " 4	71.65	69.9	30.06	56.9
9	Plaster of Paris and fire-brick	1 " 4	89.6	66.8	10.3	84.5
10	" " pumice-stone	1 " 4	55.6	57.4	3.4	94.07
11	" " furnace slag	1 " 2	148	223.6	4.7	97.8
12	" " fire brick	1 " 2	106.0	167.5	15.7	90.6

These tests were undoubtedly severe, for concrete can hardly ever in actual construction be heated to such a degree and quenched so quickly, but they prove that Portland cement resists fire better than plaster does.

SETTING.—The chemistry of setting is rather vague. It has not been clearly demonstrated what part each constituent of Portland cement plays in its setting. That the lime and silica are the greatest factors is certain, but the action of the rest is rather uncertain. Knapp, a German authority, inclines to the opinion that iron and alumina are only of indirect service, but that soda and potash, which combine with silicic acid to form silicates of soda and potash, and are in that form soluble in water, act as "transferrers of silicic acid to the lime." The time of setting of different Portland cements varies according to the class of manufacture, their freshness or staleness, and the mode of gauging. The time may therefore vary from ten minutes to ten hours. Slow-setting cements are preferable to quick-setting ones. Before beginning large sections of work the

time of setting should be tested and noted. This may be determined by gauging two or more pats of neat cement and placing them in the air. If a pat can be indented by a moderate pressure of the thumb-nail at the end of two hours, it may be considered slow-setting. The "initial set," that is, when it commences to stiffen, and the "set hard," should be timed. The initial set is noteworthy, as it indicates the limit of time within which the cement ought to be laid after being gauged. The addition of sulphuric acid or 2 per cent. of plaster retards the setting, but accelerates the maximum strength.

HARDENING.—The hardening or induration of Portland cement is as yet somewhat imperfectly understood. Various theories have been advanced as to the hardening or induration of Portland cement, but the practical causes are somewhat obscure. Knapp, a German authority, states that a portion of the calcium oxide formed during calcination reacts upon the clay and converts it into a compound easily decomposed by acids. This compound and the excess of calcium oxide, when water is added, react upon each other in such a manner as to produce a solid stone-like "silicate." Mr Guthrie, Demonstrator of Chemistry at the University of Sydney, considers that at a comparatively low temperature the lime is converted into silicate of lime, and at a high temperature induces the formation in addition to this of aluminate of lime, and finally of a double silicate of alumina and lime. This double silicate of lime, and also the aluminate of lime, on the addition of water, form hydrated silicates and aluminates, which set by crystallising. The hardness and non-absorptive qualities of Portland cement, according to another authority, are due to its structure being laminated, while that of other cements is globular, the result being that the Portland cement particles touch at all points, thus admitting of no interstices for the lodgment of water, while the reverse condition would be the case with cements where the particles were globular. The hardening results from the formation of a chemical compound of lime and silica. If Portland cement is made up with a strong solution of carbonate of ammonia no hardening takes place, but if some hydrate of lime be added the cement hardens.

SPECIFICATIONS.—There seems to be a free trade in the form of specifications for Portland cement in England, as most engineers specify the strength, fineness, &c., of the cement according to their own particular fancy or individual requirements. In Germany and Austria there are standard rules for the guidance of cement users. The German standard regulations, among other things, require that not more than 10 per cent. of the cement shall remain on a sieve with 5,000 meshes per square inch (the thickness of the wire being equal to half the width of the meshes), and that cement requiring more than half an hour to set made into briquettes with 3 parts (by weight) of standard sand, and tested after being one day in air and twenty-seven days in water, shall have a tensile strength of 227.5 lbs. per square inch, and a compressive strength of 2,275 lbs. per square inch, and that a thin pat of neat cement, which after setting on glass is placed in water, shall not crack at the edges. Mr Grant gives various intricate specifications for Portland cement, the latest being based on the German standard regulations then in force. He suggested:—1. The Portland cement, before being used, to stand 300 lbs. tensile strain per square inch seven days after gauging; the average of not less than three breakings to be taken. 2. The cement to be finely ground, leaving a residue not exceeding 10 per cent. after passing a sieve of 2,500 holes to the square inch. 3. Pat samples $\frac{1}{2}$ inch thick, made at frequent intervals, and immersed in water within one hour, to show no cracks from expansion within forty-eight hours of gauging. He thinks the weight per bushel is valueless. M. de Michele suggests another form of specification. Conditions as follows:—"Pats $\frac{1}{2}$ inch thick in water, absolutely sound at seven days. Tensile strength, 400 lbs. per square inch at seven days. Fineness, 10 per cent. residue on a 50 sieve. The pats to be gauged on glass

immersed in water immediately, and left there for the whole period. One pat to each three briquettes. The test briquettes to be gauged by a skilled man, with any quantity of water, in any way he likes. The average of three to be taken, which shall represent about 100 tons. The strain to be applied as quickly as possible. The sieve to have 2,500 holes per square inch, and to be of wire $\frac{1}{16}$ th of an inch in diameter. Shaking to be continued until nothing ground in the mill passes."

Some manufacturers issue specifications of their cement. The following is a fair specimen:—
 Weight—The cement to weigh not less than 112 lbs. per striking bushel. Fineness—To be ground so that no more than 5 per cent. residue shall be left on a sieve having 2,500 meshes to the square inch. Tensile strength—The briquettes at seven days—during six of which they shall be immersed in water—shall not break at less than 350 lbs. on the square inch. It will be noticed that these specifications contain no test for soundness or adhesive strength, both of which are most important factors for most concrete purposes and especially for plaster work.

RELATIVE FINENESS AND COST OF PORTLAND CEMENT.—Portland cement is so largely used at the present time in building work of every description that it might have been thought that users would have taken the greatest care to obtain the very best quality, not only from the desire to carry out the work satisfactorily, but because a really high-class cement is much more economical to use than one of inferior quality, and is therefore actually cheaper to buy than an apparently low-priced article. A good many users, however, are content to buy a cement bearing some well-known brand, feeling assured from previous experience that such a cement will give satisfactory results. So much attention has of late years been devoted to the manufacture that, as regards the mixing of the raw materials in their due proportions and the proper calcination of the mixture so obtained, one brand may be said to be very much like another; and provided the works are suitably designed, and the various details of the manufacture carried out with care, it may be accepted as a general rule that a comparatively unknown make of cement is in these respects equal to the best known and highest brand in the market. The true test of quality is not to be found in the brand, but in the fineness to which the cement is ground, always provided, of course, that the materials are carefully selected, and the various stages of manufacture properly carried out.

The fineness to which Portland cement is ground is an important factor in its cost and subsequent value. Cement experts show a singular unanimity in declaring that, *ceteris paribus*, a finely ground cement is far superior to one that is but coarsely or even but moderately finely ground. The reason for this fact is twofold. In the first place, a finely ground cement will spread itself over and round the aggregate of concrete better than a coarsely ground cement. Good concrete can only be obtained when every particle of the aggregate is thoroughly covered by and incorporated with the cement, and it is obvious that the aggregate can be more completely covered and surrounded by a cement as fine as flour than by a cement containing a large proportion of coarse and gritty particles.

Again, mouldings and fine finished or trowelled surfaces are more readily and easily formed with a finely ground cement than with one that is coarsely ground. But the second and more important reason is this, it is only the fine portion of the cement (technically known as the "flour" that has any cementitious or binding properties, and hence a coarse cement contains a large proportion of matter that is absolutely useless. This can be easily proved by the following simple test:—Take a small quantity of cement and sift it through a sieve of, say, 2,500 meshes to the square inch—commonly known as a 50-mesh sieve, *i.e.*, having 50 holes to the lineal inch). The portion that passes through the sieve, when gauged with water in the usual way, will be found to set hard, while the residue, or portion retained by the wires, if gauged, will never properly set.

If, however, the residue were ground up fine enough to pass through the sieve, *ie.*, ground to the same degree of fineness as the portion already sifted through the sieve, it would be found to set as readily and as hard as the first portion. Ordinary cements, such as are commonly supplied when no particular degree of fineness is specified, are ground to leave a residue of from 10 to 15 per cent. on a 50-mesh sieve. In other words, the residue being, as shown above, absolutely useless, they are for all practical purposes adulterated 10 to 15 per cent. And although the adulterant gives the same chemical analysis as the true cement, yet it possesses no more value as a cement than so much sand. But although a user may be convinced that the foregoing remarks are true, and that a finely ground cement is cheaper in theory than a coarse cement, yet he wishes to be quite certain that in actual practice it will give equally good results. On this point the superiority of fine cement is even more striking. Mr H. K. G. Bamber, F.C.S., in a paper which appeared in *The Builder*, gives a series of exhaustive tests made with a cement leaving 15 per cent. residue on a 50-mesh sieve, and one leaving no residue at all on the same sieve. Each cement was gauged neat and tested at seven and fourteen days. Briquettes (1-inch section in each case) gave the following results:—Coarse cement 440 lbs., fine cement 467 lbs., both at seven days; and at fourteen days the results were 530 lbs. for the coarse cement, and 561 lbs. for the fine cement.

A more useful test is when cement is gauged with sand, as the strength of the concrete made from it can be more correctly estimated than by tests of neat cement. Briquettes of the same cements were gauged in the proportion of 3 parts sand to 1 part cement, and were tested at twenty-eight days, giving the following results:—Coarse cement 154 lbs. per square inch, fine cement 212 lbs. per square inch, an increase in favour of the fine cement of 37.66 per cent. That this increase of strength is a true and not merely an apparent increase, is shown by further tests in which smaller quantities of the fine cement were used with the same amount of sand, as follows:—Coarse cement (3 of sand to 1 of cement) 154 lbs.; fine cement .3 of sand to .75 of cement, equal to 4 of sand to 1 of cement) 158 lbs., increase 2.6 per cent.; fine cement .3 of sand to .50 of cement, equal to 6 of sand to 1 of cement) 145 lbs., decrease 5.8 per cent. These tests show that with fine cement 25 per cent. less cement can be used and give a stronger mixture than that obtained from the full quantity of coarse cement, and that half the quantity of fine cement will only show a slight decrease of strength as compared with a mixture in which double the quantity of coarse cement is used. The cause of this superiority is, as stated above, that the "residue" has no setting or binding qualities whatever, a statement which can further be proved by the fact that if the "residue" is removed and replaced by an equal quantity of sand, the mixture of cement and sand would stand the same test and be of the same strength as the original cement gauged up neat with the residue left in it.

The foregoing proves conclusively that when a contractor buys an ordinary cement, one containing say 15 per cent. residue on a 50-mesh sieve, he buys an article that does not contain more than 85 per cent. true cement, and is therefore practically adulterated 15 per cent., and for this 15 per cent. of useless matter he pays the same price as if it were good cement. In fact, he buys so much sand at cement prices. And, further, when this 15 per cent. of inert matter is ground up, the cement is not merely 15 per cent. better, but, as the above tests prove, it is 37.66 stronger. The real amount of useless matter is much greater than 15 per cent., for a cement that would leave 15 per cent. residue on a 50-mesh sieve would leave a greater residue on a finer sieve. The finer the sieve, the greater amount of residue or inert matter, and the residue on a fine sieve is practically as useless as that on a coarse. To put it another way—a finely ground cement—no residue on a 50-mesh sieve—will go over 37 per cent. further than a coarse cement leaving a residue of 15 per cent.

on the same sieve; that is to say, 63 tons of the fine cement will give as good results as 100 tons of the coarse. These are facts that should be carefully remembered when buying cement, as they show that the lowest price cement is not necessarily the cheapest. Buyers should always compare degrees of fineness as well as prices, and if that were done they would demand a finely ground cement. One of the reasons why this practice has not hitherto prevailed to any extent is, perhaps, that finely ground cement has been difficult to obtain. Manufacturers do not, as a rule, care to grind their cement finely because of the extra wear and tear of millstones and machinery it entails; or if they do, they invariably have to charge an extra price to cover the increased expense. It is said that the difference in price between a cement of which 70 per cent. passed a sieve with 14,400 meshes per square inch, and one of which 88 per cent. passed through the same sieve, was 3s. 8d. per barrel, and it was found much more economical to use the latter. Francis & Co., Hilton, Anderson, Brooks & Co., both of London, and the Dartford Portland Cement Company, make finely ground Portland cement a specialty. They can supply a cement that will pass not less than 95 to 97 per cent. through a 76-mesh sieve, viz., one having 5,776 holes to the square inch. This is equal to less than 1 per cent. residue on a 50-mesh sieve, and is 5 per cent. finer on a 76-mesh sieve than the fine cement used in the above-mentioned comparative tests. The foregoing tends to prove that the fineness to which Portland cement is ground should regulate its price.

THE PORTLAND CEMENT TRADE.—The invention of Portland cement, as we have already seen, is of comparatively recent date. At first the demand was so small that in 1850 there were only four factories in operation, producing about 70,000 tons. There are now nearly forty factories, producing 2,000,000 tons per year. The manufacture of Portland cement was first introduced into Germany in 1852, and there are now sixty factories, producing 1,250,000 tons. A year later a factory was started in France, and there is now an annual production of 350,000 tons. The French Cement Company's factory at Boulogne is the largest in the world, and produces 135,000 tons per year. In Russia, the first factory was established in 1857, and there are now eight factories, producing 155,000 tons per year. In Belgium there are four factories, producing 136,000 tons. In Denmark, Norway, and Sweden there are ten factories, producing 135,000 tons. Portland cement was first imported into America in 1865, and there are now 500,000 tons per year imported mainly from England and Germany. The American production, owing to the unfavourable nature of the raw materials, is at present very small. In China there is only one factory, which produces 9,500 tons per annum. In Italy there are no Portland cement works, but there is a natural cement made, which is very similar to Portland cement. In Australia the manufacture of Portland cement is as yet of a limited nature. The South Australian Portland Cement Company states that briquettes of their Portland cement have attained a tensile strength of 950 lbs. to the inch—the greatest strength on record.

SLAG CEMENT.—The history of waste products is extremely instructive. Lord Palmerston declared that "dung was only gold in the wrong place." A striking example of the utilisation of waste products is found in the manufacture of cement from iron furnace slag. Another example is the use of crushed slag as an aggregate for fine concrete, and slate waste for the manufacture of plaster, cement, and artificial stone, as introduced by the author. All slags are not fitted for conversion into cement, as some do not contain the necessary ingredients in suitable proportions; while some others contain an excess of sulphur, which is dangerous to the cement made from it.

MANUFACTURE.—In 1850 a patent was obtained by Mr J. Gibbs for the manufacture of mortar by mixing slag with lime. In 1860, Mr G. Parry proposed a plan of subjecting the melted slag (as it runs from the iron furnaces) to a powerful jet of air or steam, which produces slag wool,

or silicate cotton, which is now used for a variety of purposes. Mr C. Wood, of Middlesborough, introduced further improvements in reducing slag to slag sand. The slag sand is ground with 5 per cent. of lime, and used as a mortar. It sets within twenty-four hours of being made. Messrs Bone & Walters patented a process for converting slag sand into cement. The slag is screened, and about 25 per cent. (by weight) of slaked lime is also passed through a fine sieve and added. The mixture is thoroughly amalgamated, and ground together through a machine called a "homogeniser." This consists of a revolving drum, partly filled with metal balls about 1 inch in diameter. In this drum the slag and lime particles are acted upon by the continuous blows of the balls, and are crushed to a powder sufficiently fine to pass through a sieve with 32,000 holes per square inch. These molecules are mechanically brought into the closest possible contact, thus producing a "floury-silky" powder. It is asserted that this treatment would improve Portland cement made in the ordinary way. The process of "homogenising," as compared with simple mixing, effects a vast improvement in the quality of the slag cement, its tensile and compressive strength being thereby almost doubled. The average weight is about 90 lbs. per bushel. Specific gravity is 2.73 against 3.10 for Portland.

FINENESS.—Slag cement is generally far finer ground than Portland cement. A sample of slag cement tested at Berlin left no residue at all on a sieve with 1,160 meshes to the square inch, only 1 per cent. on one with 3,870, 5 per cent. on one with 5,800, and 14 per cent. on one with 32,200 meshes.

TENSILE STRENGTH.—The following shows the tensile strength of slag cement as taken at the Royal Testing Offices, Berlin :—

TABLE VII.—TENSILE STRENGTH OF SLAG CEMENT.

	At 7 days, lbs. per square inch.	At 28 days, lbs. per square inch.
Slag cement, neat	647	692
.. and sand 1 to 3	427	509

COMPRESSIVE STRENGTH.—The average force required to crush briquettes of slag cement, gauged with 3 parts of sand, is about 3,376 lbs. per square inch at 7 days, and 4,296 lbs. at 28 days. Briquettes of Portland cement and sand similarly tested have an average strength of 4,822 lbs. at 28 days, or 12 per cent. more than slag cement ones.

USES.—Slag cement gauged neat is more plastic and works "fatter" than Portland cement. It requires from two to five hours to set. When set it has a fine white colour. It is well adapted for cast work, and may be usefully employed for plastering. The great adhesive strength, combined with its unequalled fire-resisting properties (exceeding those of both plaster and Portland cement), recommend its use for concrete stairs, floors, and roofs. It has been employed in the construction of the harbours and docks at Skinningrove, Yorkshire.

BASIC SLAG is ground at Bilston for fertilising purposes. This slag is so fine that it will pass through a mesh of 10,000 holes to the square inch. It is composed of 40 per cent. of lime and about 20 per cent. of phosphoric acid. This fine slag might be advantageously used for making slabs and for general plastering purposes.

ROMAN CEMENT.—A hydraulic cement was patented by Mr Parker, of London, in 1796 which he called Roman cement probably from its dark colour, resembling that of mortar found in Roman buildings. It is made from the septaria nodules of the London Clay formation found in the Isle of Sheppey. The septaria of Harwich also produced a cement of the same nature. A

similar material was discovered in 1802 at Boulogne. It is also to be found in the Bay of Weymouth, Calderwood in Scotland, in Yorkshire, Burgundy, and Russia. It takes the form of detached nodules of a dark-coloured argillaceous limestone, with veins filled with calcareous spar. Its colour is sometimes blue, sometimes brown or red, owing to the presence of oxide of iron. The Sheppey stone usually contains 55 parts of lime, 38 of clay, and 7 of iron; the Harwich stone 47 parts of clay, 49 of carbonate of lime, and 3 of oxide of iron. Before being burnt, the stone is of a fine close grain, of a pasty appearance, and the surfaces of fracture are greasy to the touch. The kilns used are worked on the intermittent system. It is afterwards ground to a fine powder, the quality of the cement depending upon the quality of the stone used, and the care taken in burning.

During calcination the stone loses about one-third of its weight, and when ground is of a dark brown colour. Roman cement is an admirable material where great rapidity in setting is required, and is very useful in repairing jobs. Another advantage is that it will receive paint almost as soon as finished, while Portland cement ought not to be painted until thoroughly dry—frequently the work of several months. It is sometimes gauged with Portland cement in making casts in order to accelerate the setting. Its quick-setting properties necessitate a great deal of skill and attention on the part of the workman, and it must be applied as soon as gauged.

Roman cement weighs from 70 lbs. to 80 lbs. per imperial bushel, and has a specific gravity of 0.85 to 1.00. It will not carry more than 2 parts of sand or other aggregate. Its use at the present day is very limited. It was, however, at one time extensively employed for external and internal plastering in London. In the Great Exhibition of 1851 experiments were made with Roman and Portland cement, and it was conceded that the former possessed only about one-third the strength of the latter. A superior class of Roman cement is made by Mr A. M'Ara, of Glasgow, good materials being found at Calder Glen, Orchard, and Barrhead.

SHEPPEY CEMENT.—Sheppey cement is very similar to Roman, but is of a better quality. The septaria of Sheppey, from whence it takes its name, surpasses others for making a good cement, probably from the effect of the action of the waves in reducing the less hard parts of the stone, and freeing the original nucleus of the septaria from an excess of clayey matter. Its quick-setting properties recommend its use for cast work, also for plastering in some situations.

MEDINA CEMENT.—Medina cement is much of the same class as Roman, and is made from the best qualities of septaria in the Isle of Sheppey and Isle of Wight. It sets a light brown colour, and very rapidly—almost as soon as it leaves the trowel. It is stronger than Roman, and may be taken at about half the strength of best Portland cement. Owing to its quick-setting qualities it is often used for cast work.

ATKINSON'S CEMENT.—A fourth variety of Roman cement is Atkinson's. It was formerly used for external plastering, but as with *John's Stucco Cement*, *Metallic Cement*, and others, it has been practically superseded for all purposes by Portland cement.

MARTIN'S CEMENT.—Martin's cement was the first white cement of a reliable nature having gypsum for its basis. This cement was invented by Richard Green Martin, of Lambeth, London, in 1834. It consists of an admixture of alkali and acid with gypsum. According to the specification, 1 lb of strong alkali pearl ash is dissolved in 1 gallon of water, and then sulphuric acid is added; the gypsum is soaked in this solution, then it is calcined and ground to a fine powder. In 1840 Martin obtained a patent for an improved method of making the cement which bears his name. Hydrochloric acid is sometimes added to prevent an alkaline reaction. The

cement is of a creamy colour, and sets very hard. It is chiefly used for walls, dados, and skirtings. It works clean and freely; it can be painted or papered the day after being finished. There are three qualities—coarse, fine, and superfine.

KEEN'S CEMENT.—Keen's cement was patented in 1838 by J. D. Greenwood and R. W. Keen. The first patent was for the manufacture of cement, and producing ornamental surfaces. Mr Keen afterwards made a disclaimer for the ornamental surfaces, claiming the cement only. Keen's cement is obtained by soaking the best kinds of plaster in a solution of 1 part of alum to 12 parts of water, at a temperature of 95°; after three hours the mass is removed and dried. It is then baked a second time to eliminate the water of combination, after which it is carefully ground. It is manufactured in three qualities—coarse, fine, and superfine. The last is perfectly white. This cement is capable of being worked to a very hard and beautiful surface, which takes a brilliant polish. It is largely used for internal decorations, columns, and architraves, and also forms an extremely hard plaster for walls, skirtings, &c. It can be painted on or papered within a few hours of being finished. When used for walls, the rendering coat should be formed of the coarse quality of the same material or Portland cement.

HOWE'S IMPROVED KEEN'S CEMENT.—This improved Keen's cement is prepared by a particular combination of alkalis, and treatment, that, combined with the dense granular gypsum used, give a thorough plastic material. According to tests carried out by H. Faija, this material becomes extremely hard, and also shows no indications of efflorescence or other disfigurements of any kind after being painted. The manufacturers recommend the following gauge and method for working the improved cement. Gauge 3 parts of clean sharp sand to 1 of cement; float the walls to a good regular surface, and let them remain for three days; in the meantime any mouldings or skirtings can be run. The floated walls may be then finished with a coat of neat fine cement. When the cement stiffens it should be laid down slightly at first, and as it becomes hard finish with a still joint rule. For casting enrichments, the improved cement is gauged very soft, and poured into the mould; then with a sponge press it into every part of the mould; keep squeezing the water out of the sponge, and the cement will be found getting stiff, consequent upon the sponge extracting the water from it.

PARIAN CEMENT.—Parian cement was patented in 1846, by J. Keating, a London scagliolist. According to the specification the cement is made by dissolving 5 lbs. of borax (borate of soda) in 6 gallons of water, then dissolve 5 lbs. cream of tartar in 6 gallons of water, and mix together. The gypsum stone or in form of plaster is then immersed in this solution. The mixture is afterwards calcined and subsequently carefully ground. Parian cement is so called owing to its likeness to the marble of that name. Parian cement works freer than either Keen's or Martin's. Briquettes having a sectional area of $2\frac{1}{4}$ inch at the end of 14 days give the following results:—Martin's, 580.7; Keen's, 585.8; Parian, 642.3. Parian cement sets rather quick for general use, but it has the property of resetting after being worked up a second time. It must not be supposed that this would be possible if the cement had fairly hardened, but merely if it has become stiff, when it may be made fit to use again by the addition of water. It is excellent as a finishing coat on a floating of Portland cement, as a preventive of damp on walls, and for hospital walls on account of its non-porous nature, and the smooth face which can be worked up, making the walls easy to wash. On account of the great hardness which Parian cement attains, it is also used for work in exposed positions, such as beads, arrises, skirtings, &c. It is also suitable for the manufacture of chimney-pieces, pedestals, &c. It can be painted or papered almost as soon as finished. Coarse Parian for floating purposes can

be rendered more dense and hard by the addition of a solution of white china clay in the proportion of 7 lbs. of clay to 1 cwt. of cement. The cement would require about 28 lbs. of water to gauge it. A solution of white clay in lesser proportions can be used for setting purposes to render the work closer in texture, and give a natural semi-polish.

ROBINSON'S CEMENT.—Robinson's cement was patented in 1883. It is manufactured with a basis of gypsum having an admixture of tincal (an imported material) and alum, in about the proportion of 45 lbs. of tincal and 15 lbs. of alum to 1 ton of gypsum. The whole are finely ground, and treated in a special manner. The gypsum is nearly white, and of a very hard nature, which is an advantage, as it gives greater strength to the cement when set. It is considered one of the best fireproof materials in the market; it forms a dense and hard surface. The cost is less than Keen's or Parian, and rather more than ordinary plastering. Like all other cements and limes, the sand that is mixed with it must be clean, dry, and sharp. The cement and sand are mixed dry in a gauge box, sufficient water being added to gauge them. This cement must not be knocked up a second time. Walls must be thoroughly brushed and wetted before laying on the first coat, and laths should not be more than a quarter of an inch apart. The first coat is scratched, and the second finishing coat can be laid on at once. This finishing coat is generally gauged in pails, and gauged thinner than ordinary setting stuff. Allow the cement to soak a few minutes before using. It is also used for cornices and for casting enrichments. Its non-absorbent property is a sanitary desideratum. For setting fibrous plaster slabs, also the soffits and the ceilings of concrete stairs and floors, it gives better results than gauged putty or setting stuff. It is a good cement for repairing old or broken plaster, also for alterations and additions. There is no waiting for each coat to dry; the work can be finished in one operation, and be painted, papered, or distempered nearly as soon as set. This cement is made in three qualities, viz.:—No. 1, for finishing coat on walls or ceilings, whitewashing mouldings, castings, and tile fixing; it is pure white, and can be polished to a beautiful surface; No. 2, for first coating, with sand according to requirements. The proportion of sand varies, but 2 to 1 for ceilings and 3 to 1 for walls and partitions may be safely recommended for good work.

The following table (No. VIII) exemplifies the tensile strength of Robinson's cement as tested by H. Faija in 1885. He tested its tensile strength both neat and when gauged with varying proportions of sand, as well as its power of resistance to a crushing force, with the following results per square inch:—

TABLE VIII.

	Three days from gauging.	Seven days from gauging.	Twenty-eight days from gauging.
Neat cement broke at	497	549	784
One part cement to two parts sand broke at	...	450	525
One part cement to four parts sand broke at	...	297	331

Neat cement five weeks from gauging collapsed under a crushing force of 3,761 lbs. per cubic inch.

ADAMANT.—Adamant cement was invented in America about a decade ago. It has a basis

of gypsum and sand; fine sawdust enters largely into its composition. It also contains a small proportion of dry glue, carbonate of soda, and borax. Adamant is gauged in shallow water-tight boxes, holding about two bags each. It is gauged thin, then adding as much dry material as will make it work freely. No more should be gauged than can be laid and finished in two hours. The finished work never exceeds $\frac{1}{2}$ inch thickness. Sawn laths are preferred for this material 1 inch by $\frac{1}{4}$ inch, and nailed $\frac{1}{2}$ inch apart. It is made in three qualities. No. 2, for floating ceilings and partitions, and rendering walls; this coat is laid the same as ordinary lime plaster; it is allowed to stand until the next day. No. 1, for setting walls and ceilings, is laid on as thin as possible with a hand-float, then laid down with a laying trowel, using a little adamant, and trowelling to a firm face; no more water than is absolutely necessary must be used for the final trowelling. No. 3 is called "chromolith," and gives a superfine surface. The work is first floated with No. 2 adamant, and after standing one day it is finished with chromolith. When it has been well trowelled, allow it to stand until three parts dry, then rub with a dry soft cloth until a polished surface has been produced. Adamant has been extensively used for the internal finish of many public and private buildings throughout England. Its ready application and quick drying properties are found useful for most plastic purposes.

BIRMINGHAM WATERPROOF CEMENT.—For this new plastic, manufactured in powder and a liquid by the Adamant Company, a special claim is made which may be inferred from its name. It is claimed to be waterproof, and is not injured by excessive heats or cold. It can be finished in various tints, trowelled to a polished face or stippled. It is also said to be non-porous, and can be scoured and washed without injury, and is therefore well adapted for infectious hospitals, &c. The methods of using the waterproof cement are as follows:—

FLOATING COAT.—A special material for this work, which can be used on brick, stone, wood, iron, or lath, is prepared by the Adamant Company.

FINISHING COAT (Birmingham Cement).—If a fine surface is required, the proportion of materials to cover 1 yard superficial is about 12 lbs. of powder to about 5 lbs. of liquid, worked up to a suitable paste, then applied in the usual way with a float, allowing it to slightly set; then it can be trowelled up to a fine face, or stippled as required. Before applying the above, the floating coat should be allowed to get perfectly dry, and free from dust.

STIPPLED WORK.—This will require about 15 lbs. of powder to about 6 lbs. of liquid to the superficial yard. Materials of any kind or water are not to be mixed with the powder and liquid, which must be used neat; and unless this injunction is strictly observed, the results will be totally unsatisfactory.

BASSETT'S PLASTER COMPANY.—In 1889, H. A. Bassett, a Birmingham plasterer, obtained a patent for improvements in a cementitious plaster for plastering walls and ceilings. The composition consists of dry glue, linseed oil, carbonate of soda, plaster, sawdust, white china clay, sand, and borax. This material is mixed with plaster and sand found by the plasterer, and applied to walls or lath in the ordinary way. The patentees claim that it is as cheap as ordinary mortar, gauged with plaster, and that it is fireproof, a non-conductor of sound, becomes very hard in a few hours, and can be painted upon twelve hours after completion. No special experience is required in using this material—any plasterer can use it with ease. The quantities and methods of gauging are as follows:—

FLOATING COAT.—1 $\frac{1}{2}$ pails sand, 1 $\frac{1}{2}$ pails plaster, and 1 pail composition. This is gauged in a box with water, and then laid on walls or lath not less than $\frac{3}{4}$ inch thick.

SETTING COAT.—This is best mixed in a reserve box, dry, and passed through a fine sieve.

1½ pails plaster and 1 pail composition. Gauge in a pail half filled with water, and stir up with a flat piece of wood until fit for use.

CORNICES.—For the backing or roughing out, gauge the same as floating coat. A cornice finishing is supplied ready for use, only requiring to be gauged same as setting coat. Sawn or machine-riven laths 1¼ by ¼ inch only are to be used, and these not more than ¼ inch apart.

BLACKBOARDS.—Bassett's Plaster Company manufacture a specialty in blackboards, which they claim will not wear smooth. For blackboards, a floating coat is first brought up in Portland cement, and then finished with black finish. The finishing is laid in two coats with a hand-float, and then laid down with a laying trowel while soft, and trowelled off as it goes in. One bag of blackboard finish will cover about 20 yards superficial.

ASBESTIC PLASTER.—This is the latest form of plaster which has been introduced into Great Britain. It is made from asbestos obtained from the Danville mines, Quebec, Canada. Asbestos, technically named "chrysolite," is a mineralogical vegetable, both fibrous and crystalline, and elastic yet brittle. Apparently combustible as tow, the fiercest heat cannot consume it, and no combination of acids affects the strength of its fibre. It is used for a variety of purposes, especially in connection with building works, its latest development being plaster. Asbestic plaster has been subjected to many severe fire tests by experts in America, Canada, and Germany, and it has given unprecedented results as to its fireproof qualities. Since its introduction into this country it has been successfully used in many important public and private buildings. It has been extensively used in Canada and America by architects of the highest standing. Being composed exclusively of asbestos it is absolutely fireproof. It is odourless, and vermin proof, and contains no organic matter, therefore its sanitary advantages are very considerable. Owing to its elastic, adhesive, and tough nature there is no fear of its cracking or crumbling. Asbestic, besides being a perfect non-conductor of heat, is also a non-conductor of sound. For iron and steel columns, &c., asbestic is invaluable; exhaustive tests have proved that it is not only a protection against fire but it entirely preserves metals from corrosion. No special knowledge is required in using asbestic, as it is laid and finished in a similar way to lime plaster. It is easy to mix, and simple to manipulate. For brick walls two coats are used, and for lath work three coats for best work.

Directions for using as given by the owners are as follows:—For rough coat, slake about 3 cwt. of lime, and while liquid run through a sieve into a box large enough to hold 1 ton of asbestic, mix thoroughly, adding requisite amount of water. It is recommended, whenever possible, that after the lime and asbestic are thoroughly mixed, the plaster be allowed to stand at least twenty-four hours before being used. For finishing coat, mix two parts of lime to one of "asbestic finish." Asbestic plaster is packed in bags of 100 lbs. each.

STONE CEMENT.—Stone cement is now being largely used in Paris for renovating stone buildings, and is believed to be similar to the cement made by M. Duval. Plasterers are often called upon to repair stone work with some local cement, and a description of this material is given, as likely to prove useful. The powder which forms the basis of the cement is composed of 2 parts of oxide of zinc, 2 of ground hard limestone, and 1 of pulverised grit. The desired tint is obtained by mixing with ochre or other requisite colour. The liquid with which the cement is gauged consists of a saturated solution of 6 parts of zinc in commercial muriatic acid, to which is added 1 part of sal-ammoniac; this solution is diluted with two-thirds of its volume of water. The cement must not be gauged until required, and not more than can be conveniently used. No plain water must be used for gauging; only the solution as described. It is gauged in the proportion of 1 lb. of cement to 5 pints of solution. This cement sets very quickly, and attains great hardness.

PARIS CEMENT.—“Ciment de Paris” is the invention of M. Vallin, the Director of the Gypserie de la Gare, a French cement manufactory. It is claimed by the inventor to be at least equal in quality to English cement, and it is said to possess the durability and the cold appearance of marble, and that a wall floated and set with it becomes impermeable to moisture. It can also be polished and brought to fine face. In the usual method of manufacturing cements it is generally found very difficult to obtain a thorough burning of every piece of stone. In order to obviate the unequal burning, the stone is first ground to a fine powder, which is in turn automatically placed on sieves which shift it into pans heated by gas. A series of inclined plates, having a gyratory motion, agitate the powder in each of the pans, thus exposing every particle to the influence of the heat.

SELENITIC.—Selenitic derives its name from selenite, the chemical term for gypsum. Patent selenitic was invented by General Scott in 1870. Selenitic sets quickly, and forms a good groundwork for Keen or other white cements. It is usually made by gauging about 5 per cent. of plaster (at the time of using) with any lime having hydraulic properties, Lias being considered the best. Lime may also be selenitised by mixing with it sulphuric acid, or by adding a small proportion of any sulphate. The effect of the sulphate in the lime is to arrest the slaking action, to quicken its setting, to give the lime a considerable increase of strength, and to enable a large proportion of sand to be used. Selenitic is prepared for plastering either by means of a mortar mill or a tub. If in a mortar-mill, pour into the pan 2 full-sized pails of water, then gradually add 1 bushel of selenitic, and grind to the consistency of lime putty in a soft state; then throw into the pan about 5 bushels of clean sharp sand, hard burnt clay ballast, or broken brick, which must be thoroughly incorporated. If necessary, water can be added to this in grinding, which is preferable to having an excess of water to the prepared lime before adding the sand. The water and selenitic must be mixed together first, and where the improved style of self-discharging mortar is used, it is recommended to mix the selenitic and water in a tub (as explained hereafter), adding the paste to the sand or other aggregate proportionately as required. If prepared in a tub, pour in 6 pails (18 gallons) of water, and gradually add 3 bushels of selenitic, keeping it well stirred until thoroughly mixed with the water to the proper consistency. Form a ring with half a yard of clean sharp sand, into which pour the mixture from the tub. The whole gauge is then turned over three or four times, well mixing with a larry, adding water as required. The tub should be able to contain about 40 gallons, or an oblong box or trough with a sluice may be used. Selenitic should be kept in a dry place until used. Plastering with selenitic on brick work or stone may be floated in a similar manner to Portland cement, and requires no hair. For plastering with selenitic on lath work, pour in 6 full-sized pails (18 gallons) of water and 3 bushels of selenitic, adding only from 9 to 12 of clean sharp sand, and 3 hods of well-haired lime putty. When the mill is used, the haired putty should not be put in the pan until the mixing of the selenitic and sand is nearly completed, and should only be ground until the haired putty is mixed, because long grinding destroys the hair. The gauge will be found to answer well for all classes of lath work, if the sand is very sharp. Nine bushels of sand (in the proportion of 3 of sand to 1 of selenitic) will be found to answer well for first coating the lath, and 12 bushels of sand (in the proportion of 4 of sand to 1 of selenitic) may then be used for the floating after the first coat is set. For common setting, the ordinary method of finishing with putty lime and washed sand may be adopted. When a selenitic face is required, the prepared selenitic may be first passed through a fine sieve, so as to avoid the possibility of blistering, and used in the following proportions:— 4 pails of water, 2 bushels of selenitic, 2 hods of lime putty, and 3 bushels of fine washed sand. This is used in the same way as trowelled stucco, being well hand floated and trowelled.

which will produce a very hard surface. The latter method of working selenitic is preferred by the workmen, because the putty lime makes it work "fatter" than the method of adding the plaster only, which works very "short" and heavy. Selenitic should not be used in conjunction with gauged stuff for cornices, angles, or screeds.

SELENITIC CLAY FINISH.—The use of ground selenitic clay is said to improve mortar, and render it more hydraulic. The proportions are as follows:—1 bushel prepared selenitic, 3 bushels prepared selenitic clay, 2 bushels washed sand, 1 hod of chalk lime putty, and 13 gallons of water. The mixture is well gauged and laid, floated true, and hand floated twice. It is then trowelled until a good fair face is obtained. For outside work, a larger proportion of sand may be used, say from 5 to 6 bushels of sand to the same proportions of the other materials. Selenitic has been used as a plastering material for many large works, including the Manchester Town Hall, Drummond's Bank, and the Law Courts, London.

HYDRAULIC CEMENTS.—Hydraulic cements and plasters are those which have the properties of setting and hardening under water. They generally consist of silica and caustic lime. Clay and magnesia impart greater consistency and strength to the compounds. The history of Smeaton's search after a mortar capable of resisting the inroads of the sea, which he undertook preparatory to building the Eddystone Lighthouse, is of much interest, and his discovery is really the genesis of an important industry—important in itself as regards the many thousands employed in the actual manufacture and use of Portland cement, but more important still in regard to its influence on the trade and commerce of the world, and the possibilities which it has afforded for their development. Although Smeaton did not invent any particular cement, he was the first to discover that the hydraulic properties of lime depended upon the combination of the lime with clay. To this circumstance the discovery of cement is due, and the marvellous advance we have made in all matters relating to hydraulic engineering has been rendered possible.

General Pasley, who studied and experimented on this subject, says of Smeaton: "Of all the authors who have investigated the properties of calcareous mortars and cements from time immemorial to the present day, our countryman, Smeaton, appears to me to have the greatest merit; for although he found out no new cement himself, he was the first who discovered, in or soon after the year 1756, that the real cause of the water-setting properties of limes and cements consisted in a combination of clay with the carbonate of lime, in consequence of having ascertained by a very simple sort of chemical analysis that there was a proportion of the former ingredient in all the natural limestones which, on being calcined, developed that highly important quality without which walls exposed to water go to pieces, and those exposed to air and weather only are of comparatively inferior strength. By this memorable discovery Smeaton upset the prejudices of over two thousand years, adopted by all previous writers, from Vitruvius in ancient Rome, to Belidor in France, and Semple in this country, who agreed in maintaining that the superiority of lime consisted in the hardness and whiteness of the stone, the former of which may or may not be accompanied by water-setting or powerfully cementing properties, and the latter of which is absolutely incompatible with them.

"The new principle laid down by Smeaton, the truth of which has recently been admitted by the most enlightened chemists and engineers of Europe, was the basis of the attempts made by Dr John at Berlin, and by Vicat in France, to form an artificial water lime or hydraulic lime in 1818, and of mine General Pasley's to form an artificial cement at Chatham in 1826, to which I was led by the perusal of Smeaton's observations, without knowing anything of the previous labours of those gentlemen on the Continent or of Mr Frost, the acknowledged imitator of Vicat in this

country. Every author on lime or cements that I have met with followed the authority of Vitruvius until after the middle of the last century, when Smeaton came into the field and pointed out the inaccuracy of his doctrines in the same manner as Bacon had set aside the implicit belief in the doctrines of Aristotle in matters of philosophy."

BARROW HYDRAULIC PLASTER.—This material is used for plastering, and will carry the same quantity of sand as ordinary plaster. It does not require so much preparation, and the running of lime is entirely avoided. Consequently there is a saving in labour. It sets quickly and attains great hardness, is non-absorbent and does not blow. It is strongly hydraulic, is gauged in the proportion of 1 of hydraulic plaster to 2 or 3 parts of clean sharp sand, mixed well together in a dry state, and then adding sufficient water to make it work as ordinary plaster. The principal seat of manufacture is at Leicester.

HYDRAULIC PLASTER LIME.—Hydraulic plaster lime has a basis of Arden lime, and is especially prepared for plastering purposes by Mr A. M'ARA, whose effort in this direction is the first of its kind in Scotland. The material, as prepared for the market, is finely pulverised, and needs only to be mixed with sand and water to be ready for use. It requires no slaking, but will keep for a year or more in barrels or sacks without deterioration. It has all the smooth and slow-setting qualities and the sand-carrying capacity of common lime, and when used it does not "blister." This material may be added to ordinary lime to give coarse stuff or setting stuff hydraulicity and increased strength. It is practically fire and damp proof.

GRANITE PLASTER.—Calcined gypsum forms the basis of granite plaster. The raw material is specially treated, so as to form a hard and quick-drying plaster for interior work. Like similar cements or plasters, it is designed as a substitute for the ordinary lime and hair plastering. Granite plaster permits of the work being rendered and floated in one coat, and set the same day. The work may also be painted or papered in two days from finishing. Granite plaster is delivered in sacks ready for use. It is gauged in a box with water. No more must be gauged than can be used in one hour. In addition to that already described, the Granite Silicon Plaster Company now manufacture a plaster for plasterers to mix their own sand. This, when distance and carriage is a large item, enables plasterers to bring the cost down to be almost as cheap as lime and hair plastering. The material first named is already mixed with sand ready for use for the trade in London, or within four miles of their factory. Granite plaster is an excellent material where time is limited, as the floating and setting can be laid on the same day, and it attains great hardness. Its fireproof properties adds to the general value of this plaster.

SIRAPITE.—Sirapite plaster is one of the most recent inventions as a substitute for lime and hair plaster. It is formed from a basis of coarse dark, yet hard gypsum, obtained from the Sub-Wealden Gypsum Works. It is claimed by the manufacturers to be fireproof, labour saving, economical, and durable. It is free from glue or other such organic compounds, and is therefore perfectly hygienic, absorbs very little water, and dries quickly. Its use is very simple, as it is delivered already prepared, requiring no lime or hair, but only the addition of water for the purpose of gauging. It is very suitable for plastering walls and ceilings, and is invaluable for any kind of plastering repairs. Sirapite takes the place of the two ordinary first and floating coats of lime plaster. It is superior to the ordinary lime plaster in point of speed in drying and hardness. It is equally durable, and certainly much cheaper than most of the many patent plasters of the present day which are used for the interior finish of buildings. For general internal plastering the cost is about the same as ordinary lime plastering. The material being delivered in bags, it can be gauged in the several rooms where it is required, and it is unnecessary to provide putty

pits and space for making coarse stuff and setting stuff; hence an immense saving in working and carrying wet materials. Owing to the great strength and tenacity of this material, only a thin coat is necessary, thus effecting a saving in the amount of material and labour in using. Two coats only are needed, the second following the first in twenty-four hours. It is easily gauged and applied, and requires no special knowledge or practice in using. It can be used for new work, also for repairing old work with advantage. Although not absolutely necessary, sawn laths are best adapted for its use, as they form a more uniform surface, therefore require less floating material, and prove more economical. When dry, it is of a light slate colour, and is extremely hard, and not liable to crack or blow. A beautiful creamy colour can be obtained if desired.

Sirapite quickly becomes hard, dry, and smooth, and admits of being papered or painted in a very short time. For ceilings and lath work, an equal measure of clean sand may be added for floating coats. For best work, or where time for drying and painting purposes is limited, the material should be used neat. In this case the lath nails should be galvanised or painted. For brick or stone walls an equal measure of clean sand may be added for the floating coat. For ordinary work, 2 parts of sand to 1 part of sirapite may be used for the floating coat. This material is gauged in a banker the same as ordinary cement. Sirapite finish may be gauged in a pail of water, allowed to settle, and the surplus water poured off. It is laid and trowelled off in the same manner as gauged putty and plaster. For all purposes clean water must be used for gauging. Owing to the initial "set" beginning nearly as soon as the material is gauged, it should be used at once. Excessive gauging or prolonged trowelling should be avoided, as they tend to retard the setting and the ultimate hardness of the material.

BLOOMFIELD'S SHALE PLASTERS.—Shale plasters were patented in 1891 and 1893 by Mr Bloomfield. Wall rendering consists of from 2 to 3 parts of raw shale, and 1 part of hydraulic lime. Fibrine rendering is a similar compound with the addition of sawdust. Shale plaster is made in Ireland. It has been used in several public and private buildings in and around Dublin, and has given general satisfaction. It is claimed that it is as cheap as ordinary lime plastering, and superior in point of hardness. For the sake of Irish enterprise, the merits of this material should be universally known and used throughout Ireland. The following is a brief description of the various kinds and methods of using:—

WALL RENDERING.—This plaster is used on brick or stone walls. It dries hard, and may be set within forty-eight hours after it is put on. From 25 to 30 lbs. is required for 1 superficial yard. When using this rendering, gauge the plaster with clean water in the same manner as ordinary lime plaster. Brick walls should be well damped before application, to guard against quick absorption.

FIBRINE RENDERING.—This is used as a rendering coat on ceilings and lath work; 20 lbs. will cover 1 superficial yard.

SHALE FINISH.—This is a grey finish, and used for ordinary work; 4½ lbs. will cover 1 superficial yard. French grey enamel is a beautiful grey, specially adapted for public buildings; 5½ lbs. will cover 1 yard square. Shale or French grey enamel should be mixed with clean water, in the same manner as ordinary plaster, and worked to a creamy state, then laid on quickly, and trowelled as quickly as possible.

PETRURA PLASTER.—This new patent plaster is used as a substitute for lime plaster. It is compounded from "schist" as a basis, and possesses the advantages of being sanitary, impervious, and fireproof; indeed, possessing all the properties that a perfect plaster should have. The qualities of lime and most hydraulic cements are present in this material. It does not crack or

blister, and the ceiling and walls do not require saturating with water. Two coats are needed, the second following the first in twenty-four hours. The thickness of the combined coats is about one-third less than is required for lime plastering, hence an immense saving in labour of carrying and working. Petrura plaster when dry is of a pleasing pearly grey, but it can be supplied in any reasonable colour. The colouring matter being a part of the plaster, it forms a permanent surface colour, and it can be washed without injury to the colour or the plaster work. The cost of Petrura plaster is about the same as lime plaster, but taking into consideration the thinner coat required, and that it possesses greater strength and hygienic properties than ordinary lime plastering, it is undoubtedly the cheaper in the end. It is supplied ready for immediate use by gauging with water. This is a very convenient and reliable method, as it offers fewer opportunities for adulteration. By the use of this material the plastering of a building can be completed in a lesser time than required by the ordinary method as used for lime plaster.

IRON PLASTER.—The following is an improved process for hardening plaster. It is made by adding 1 part of fresh slaked lime, finely sifted, to 6 parts of plaster. The lime is sprinkled while the plaster is being gauged. This limed plaster is gauged as stiff as practicable, and laid, ruled, and trowelled off without delay. The rule and trowel must be used as sparingly as possible. The surface is ironed, by working a laying trowel on its flat, with a quick circular motion, using more elbow-grease than time, and leaving off as soon as the surface is smooth, dispensing with the many finishing touches which some men think are necessary for a fine finish. When the work is thoroughly dry, the surface is well saturated with sulphate of iron. The surface then becomes nearly black, but the plaster has greatly increased in strength, the resistance to breaking being nearly twenty times the strength of ordinary plaster. If the surface is required to resist excessive friction and wet, it is brushed over twice with hot "litharge oil."

BLACK FINISH.—A finished black surface is often required for walls and floors of tennis and racquet courts. Portland cement mixed with oxide of black manganese is sometimes used. Steronite plaster, being of a hard nature and black in colour, is also suitable. A deeper black and harder surface may be obtained by brushing the surface with copperas. Patent mineral black, invented by Joseph Bickley, a prominent London plasterer, has been successfully used for this purpose in many London and provincial courts. The following is an American method used for blackboards:—Clean the walls, and first-coat them with a coat of strong gauged coarse stuff. When dry, float them with hydraulic lime or selenitic. When the floating is dry, finish with setting stuff, coloured black with dropblack, or lampblack dissolved in alcohol. When this is dry, apply two coats of black solution made as follows:—1 lb. of white shellac, $\frac{1}{2}$ lb. of powdered pumice-stone, $\frac{1}{4}$ lb. lampblack, dissolved in 1 gallon of pure alcohol.

In 1884, N. F. Potter, of Providence, America, obtained a patent for "improvements in compounds adapted to be used for making surfaces or blackboards, or for hard finish on plastering." The following is an extract from the specification:—

"The object of this invention is the production of a compound which, when 'set,' shall be hard and comparatively indestructible. Such compound may be used for various useful purposes, such as for the production of surfaces for blackboards, as a finish for plaster, &c. When used for the production of marking surfaces or blackboards, the compound is made from soapstone or talc, alum, lime putty, black sand, silica, and mortar black. The soapstone or talc is finely pulverised, the lime putty is made from burnt lime with water mixed therewith to give it the consistency of mortar, the alum, black sand, silica, and mortar black are all pulverised or finely powdered and sifted or screened, and all of said ingredients or substances are mixed together, to be used for the

marking surface or blackboard in about the following proportions:—Soapstone or talc, 100 lbs.; alum, 7 lbs.; lime putty, 100 lbs.; black sand, 100 lbs.; silica, 100 lbs.; mortar black, 88 lbs. The above-named substances in substantially the proportions given are mixed together in a suitable receptacle, sufficient water being added to render the composition or coating sufficiently plastic to be easily spread on any surface, and when it is thus ready for use one-fifth part of plaster of Paris is added thereto. The blackboard composition or coating may be applied as follows:—The common brown mortar is applied to the laths of the wall or other surface in the usual way, and scoured to an even surface ready to receive the blackboard or marking compound or coating. The said coating, having been previously prepared in the manner above described, is then spread upon the surface of the mortar or plaster with a trowel to a thickness of about $\frac{1}{2}$ inch, and smoothed so as to leave an even surface, which is then brushed with a dry brush, giving a smooth black surface especially adapted to be used for marking surfaces or blackboards without requiring any further attention. The compound for marking surfaces or blackboards above described may be used for a hard finish or plastering by leaving out of said material or compound the black sand, silica, and mortar black, with the plaster of Paris. If the compound is to be used for forming a hard finish or plastering, the soapstone is pulverised with alum in the proportion of 7 lbs. of alum to 100 lbs. of soapstone, 1 part of slaked lime or putty to 2 parts of powdered soapstone and alum are mixed together, and a sufficient quantity of water stirred therewith to render the whole of the proper consistency to be spread upon the plastering with a trowel in the ordinary way. The material thus formed is spread upon the face of the plastering and rubbed over it with a trowel, thereby producing a hard finish upon the plastering of very perfect and enduring character. If it be desired to have a very glossy or polished surface, powdered soapstone may be applied dry, or mixed with water, after which the plastering is rubbed over with a trowel when the soapstone has been applied in a dry state, and with a brush when applied mixed with water. There are many different shades of soapstone, so that the manufacturer of the compound can give the hard finish different shades as desired by selecting from the different coloured soapstone, or, if preferred, colouring matter may be mixed with the pulverised soapstone, alum, and lime putty. By 'soapstone' in this specification reference is made to the soft magnesian mineral technically called 'talc.'

AMERICAN PATENT PLASTERS.—America is prolific in the production of patent plasters or machine-made mortars. The most prominent patent plasters in America and Canada are the Adamant, King's, Windsor, Paristone, Rock, Paragon, Standard, Diamond, Economic, Dillion's, Asbestic Plaster, Aluminite Cement Plaster, Acme, Aggratite, and Royal. The last four all claim to be nature's own plastering, as they are made from a clay or earth found in the Western States which requires only calcining to make cement.

Adamant, the first and most prominent, was the result of a patent by Carl Straub for a compound to increase the strength and hardness of calcined plaster. A company was formed in Syracuse, which succeeded in making a good wall plaster from this patent. They then sold territorial rights throughout the United States and England—to make Adamant wall plaster from their patent and formula—retaining to themselves the manufacture of the chemical retarder and hardener upon which the patents were based, and selling them to licensees. Their formula required the mixture of their chemical with calcined plastering sand and other ingredients, and the selling of a completed product ready for use with addition of water only. The local materials in different territories—even the sand and very often the water—differed so greatly that the licensees were obliged to alter and change the formula to such an extent that they became so expert that many of

them made their own chemical and renamed their product. In this way most of the varieties in the market to-day have originated—many have changed their method by making the cement or plaster complete, excepting the sand, which is added by the plasterer when using the material. This cheapens the product by lessening the cost of freight and cartage.

In a factory where these cements and plasters are made, the mixture is generally exact and governed by weights; each maker has tested and mixed his proportions, and the resulting product is uniform. When one of these plasters is specified there is a reasonable certainty of strong sound work, although it may not look as well as the old lime mortar. Owing to the better material, it is more expensive, and to keep down the cost it has to be put on very thin. This does not injure the quality of the wall, but the opportunity to straighten the defects of carpenter and bricklayer are greatly lessened. Most of the plasters in the market are good, and deserve attention. If they are not used and specified, much greater care than is usually exercised by architects is required if they wish to get good lime mortar.

LATHING.—Lathing is used on wood, joists, studding, &c., to form a foundation for plaster work on ceilings and partitions. Plastered partitions were introduced about the end of the sixteenth century. Lathwood is a straight-grained wood, the outside of fir-trees being used for splitting into laths. Red Baltic timber makes the best laths. Lath-splitting seventy years ago may be said to have been in its infancy compared with what it is now. Lath rendering or splitting was formerly done entirely by plasterers, and was a profitable source of employment in the winter months. Lath driving or nailing was also allotted to them, but owing to the subdivision of labour, lath-splitting and nailing in most large towns has become a branch trade, although it is in some places still done by plasterers. Laths were formerly all made by hand. A large quantity, however, are now made by machinery. The latter are known in the trade as "sawn laths." An old method of lathing was done by sawing broad timber into thin boards about $\frac{1}{4}$ inch thick, and in width from 3 inches upwards. The boards were split in position to give a key. Samples of this class of work are still to be found when repairing old plaster work. Laths are now made chiefly from Baltic or American timber. This should be specially selected, cut into lengths, and split by wedges into bolts, with a dowel axe into fittings, and with a chit split into laths.

Laths are usually purchased by the load, bunch, or bundle. A bundle of ceiling laths is computed to contain 500 lineal feet, but in many parts of the country they are still reckoned by the long thousand or 1,200 feet, and hence a bunch will contain 100 4-foot laths, and a bundle will contain two bunches, and will cover 7 yards superficial. A standard bundle should contain seven score 3-foot, six score 4-foot, and five score 5-foot laths. These terms and quantities are somewhat confusing, and vary according to the locality. Machine or sawn laths are fast superseding hand-made laths. Those split by hand give the best results, as they split in a line with the grain of the wood, and are therefore generally stronger, and are not so liable to twist as machine made. Cast-iron nails are used for common work; wrought nails in high-class work. Galvanised wrought-iron nails have been introduced to prevent rusting. Laths should be selected in lengths best suited to the spaces between the joists from centre to centre, and should be fixed about $\frac{3}{4}$ inch apart. In common work the ends overlap, but for good work they should be made to butt against each other. This is known as "butt work." They should also be made to break joint in bays every 3 or 4 feet in width. This gives a better key, and prevents the cracking of the ceiling or wall along the line of joists. When ordinary laths are used, the studding and joists should never be over 14 inches apart from centre to centre. The thickest laths are used for ceilings, lath and a half for partitions, and battened or

studded walls for good work. Single laths are used for ordinary work, stoothed walls, or partitions. All timbers over 3 inches wide should have fillets or double laths nailed along the centre, and the laths nailed to them. This is done to give a better key to the plaster, and is known as "counter-lathing." Reeds, wickerwork, slates, and wire have been used as substitutes for wood lathing. Wire and metal sheets are now greatly in vogue as fireproof and material-saving lathing. These are described as follows:—

METAL LATHING.—The employment of wire netting or metal sheets as a substitute for wood lathing is an economical and effectual method for resisting fire, and forms a durable and firm foundation for plaster work. Wire netting was invented by Edmund Cartwright, who obtained a patent in 1797. As described, it is simply a wire netting securely stapled to the furring or joints. Wire lathing used in certain Government buildings erected in Paris during the reign of Napoleon I. is still in good preservation. It has also been used in American theatres, notably at Boston since 1853 on walls behind the scenes subjected to rough usage, yet it retains its hold. Another use to which it has been put to in America is for the inside of freight cars, to render them when plastered more suitable to convey perishable goods. Wire lathing was first used in England in the construction of the Pantechmicon, Belgrave Square, in 1841, by Leconte. There are several other patents for metal lathing which have been introduced during the last two decades, among which the following may be enumerated:—

EXPANDED METAL LATHING.—Expanded metal was introduced in this country about six years ago by the inventor, Mr J. T. Golding, of Chicago, whose process is now worked by the Expanded Metal Company Limited, London. The principal use to which the metal has been applied is as a metallic lathing for fireproofing, and it has been largely used for this purpose for many of the most prominent buildings throughout the country, and has met with the general approval of architects, builders, and plasterers, for ceilings, partitions, cornices, and encasing iron work, &c. The metal is cut and opened out into a network by an ingenious process, the strands forming the meshes being almost at a right angle to the plane of the sheet before it is cut, so that the plaster becomes dovetailed in position and a perfect key is obtained.

By means of a recent invention the process of manufacturing expanded metal has been so completely revolutionised that the material now produced is not only improved but vastly cheapened, and is made in such increased varieties of weights and sizes of meshes as to greatly enlarge the scope of its usefulness. As a building material it has assumed a place of first importance in the construction of floors, suspended ceilings, and solid partitions, which save from 4 inches to 4½ inches on each wall, while the ease with which the metal can be applied for encasing iron work ensures its use becoming more and more general.

Owing to the small amount of sheet metal used in proportion to the area of the expanded sheet about one-third, the expansion or contraction of the metal is not sufficient to cause cracking of the plaster. The metal can also be used for exterior work with Portland cement, and was adopted for the model of the Eddystone Lighthouse at the Naval Exhibition in 1891, and later on at other exhibitions, including the Galatea Tower and Hall of 1,001 columns at Olympia, &c.

STANLEY'S PATENT CORRUGATED WOVEN-WIRE LATHING.—The leading advantages claimed by the inventor are rapidity and security of fixing and fireproof powers.

"JHILMIL" PATENT METAL LATH.—The Jhilmil lath is an ingenious yet simple method of steel lathing for plastered ceilings and partitions, which combines strength with a perfect key for the plaster or cement. The Jhilmil lath forms an important feature in fireproof construction. It is made of steel, in sheets 5 feet by 18 inches, 5 feet by 24 inches, 6 feet by 12 inches, and 6 feet by

18 inches, convenient sizes to handle and to avoid cutting to waste, readily and quickly fixed by wire or clout nails to woodwork, or wired to iron uprights.

Its peculiar shape provides for expansion and contraction. The sheets are easily cut by an ordinary pair of snips, and being flexible, it readily adapts itself to any form, and may be used for cornice brackets, coves, and circular work. The key perforations being uniform, afford a firm hold for the plaster or cement, which is evenly distributed and laid. Just enough goes through to grip round the loops; the key is so perfect and solid that the plaster cannot be detached. The Jhilmil lath is easy to plaster, and takes a minimum for first or rough coat; and owing to the strength and evenness of the Jhilmil, the first coat for most purposes may be brought up direct from the lath in one operation to form a floating coat, and finished with the second coat.

Joists or studding may be spaced at 12 inch, 15 inch, or even 18 inch centres. When fixing Jhilmil lath, sheets should overlap about $\frac{1}{2}$ inch sideways, the nails about 3 inches apart. The Jhilmil lath is also effectively used as a fireproof protection to iron and wood columns, girders &c., as the peculiar corrugations give sufficient air space, so that when plastered they are rendered impervious to fire. The Jhilmil lath is well adapted for the construction of partitions. A strong and fire-resisting partition can be formed by simply nailing the sheets to wood studs or battens, which can be spaced at more than one half distance that generally admissible for ordinary wood lathing.

Jhilmil fixed to light iron supports forms an indestructible solid partition, besides economising space, a great desirability in many kinds of buildings. For solid fireproof partitions, uprights of 1-inch T or H iron section are secured by shoes at the top and bottom, and the Jhilmil lath wired on one side, and then the whole can be plastered on both sides to form a solid partition $1\frac{1}{2}$ inch to 2 inches thick. Before plastering the steel lath, it should be steadied temporarily by light raking strutting on one side, and then plastered half-way up on the other side from the bottom. When the plaster is getting dry, or sufficiently firm, the strutting should be removed and the back of the lower half plastered; then the top half can be plastered, and the partition completed.

The Jhilmil lath having the same form on both sides, a strong and uniform key is obtained, thus making a strong and compact body of steel and plaster, the whole being a perfectly sanitary, vermin-proof, and fire-resisting partition. The weight of Jhilmil lath, including plaster, is about 5 lbs. per foot superficial. It has been extensively used in many public and private buildings.

The patentees state that "a piece of Jhilmil lath, 6 inches wide, plastered and laid on a clear bearing of 18 inches, carried $1\frac{1}{2}$ cwt. in the centre without any detriment. The advantages claimed for the Jhilmil patent lath are:—Reduction in cost of fire insurances, fewer supports, and saving of space in thickness of partitions; the readiness with which it is fixed saves half the time for labour, besides nails; the roughing-out coat is entirely saved, and very little plaster is forced to the opposite side; time in drying, as the plaster can be used stiffer, and using less in thickness than ordinary three-coat plaster-work, it will dry in less than half the time required for ordinary wood, lath, and plaster work; fireproof protection to temporary buildings, and to sides of lifts and other shafts; the mortar will go twice as far on the Jhilmil lath compared with wire lath, and a workman can fix twice as much of the Jhilmil lath on walls or ceilings compared with wood lath, and can cover twice the surface he can of wood or wire lath in a given time." The application of Jhilmil lath for various purposes is illustrated by details in the advertisement pages.

THE BOSTWICK PATENT FIREPROOF METAL LATH.—The Bostwick patent metal lath is an American invention, and has been extensively used in that country. Although recently introduced into England, it has been already largely used for many public and private buildings throughout

the country, and has given every satisfaction. The Bostwick patent metal lath makes a stronger and better fire-resisting foundation than wood lath, and one which is less liable to crack from settling of walls or deflections of ceilings. Owing to the peculiar loops and corrugations, the plaster is firmly keyed, and cannot possibly be detached or fall off. The patentee claims that a plasterer can put on about three times as much of this lath in a day as he can of wood lath, and that a plasterer can lay more than double the number of square yards on this lath than he can on the wood lath in a given time. Also, that a given amount of plaster will cover nearly twice as much surface on this lath as it will on the wood lath, because the surface of the metal lath to be covered is even and unyielding, and the openings being uniform, are sufficient to guarantee a stronger key, and will not admit of waste mortar falling off from back of the lath. A finished wall with this metal lath will cost but little if any more than when wood lath is used, because of the great saving of material and labour. This metal lath is fireproof, therefore a large saving is realised on insurance where it is used. This lath is easily and quickly fixed. For fixing to iron uprights specially made clasps are used.

JOHNSON'S PATENT GALVANISED WIRE LATHING.—This is formed of wire netting $\frac{3}{4}$ inch or smaller in mesh, laid on strips of varnished hoop-iron, and fixed with staples edgeways across the joists. The netting is then spread on this backing and stapled to the joists.

PATENT METAL LATHING SHEETS.—These are sunk and dovetailed on both sides, and having serrated edges form a double key for the plaster.

HELICAL METAL LATHING.—This is the invention of Mr T. L. Banks. It is made of flat steel wire or ribbon, twisted and woven into convenient size. The stock size is 10 feet 6 inches by 2 feet 6 inches. It is fixed by hooks.

PATENT REED LATHING.—This is a German patent, recently introduced into England, and consists of webbing formed with reeds or rushes secured by wires. Ceilings are constructed by nailing first a close and then an open webbing to the joists. Both kinds of webbing are made in rolls of 20 square yards, in widths of from 1 to 2 yards. There is nothing novel in the use of reeds as lathing, as they were the forerunners of wood laths in England—in fact, reeds were used in plaster work in many countries long before the Christian era.

SLATE LATHS.—Slate lathing was introduced by Nicholson and Waddington nearly a century ago. Slate laths were at one time largely used in Manchester. They were made of waste slates of good quality, but which had been either spoilt in the cutting, or were too narrow for the regular sizes. They measure from 12 to 18 inches long, and are of various widths.

PLASTER AND WIRE LATHS.—A novel lath has been patented in America by Mr W. Garvey. It consists of a bar of plaster cast in a mould around a stiffening and strengthening wire. The edges are tongued and grooved so that the entire series of laths may be locked together. These laths are made in lengths from 12 inches to 48 inches, and in widths from $1\frac{1}{2}$ inches to 2 inches. The laths are secured in place by wires looped over nails driven into the sides of the joists. The contiguous ends of the laths are separated about $\frac{1}{2}$ inch, and the intervening space is filled with plaster, making a flush joint, and at the same time fastening the laths by enveloping the wire core which is allowed to project beyond the ends of the lath. After they are fixed, the whole surface is set with gauged putty and plaster or any desired white cement.

CHAPTER IV.

LIME PLASTERING.

PLASTERING—PLASTIC TERMS—THREE-COAT WORK—FIRST COATING—RENDERING, FLOATING, SCOURING, AND KEYING COARSE STUFF—SETTING—SCOURING, TROWELLING, AND BRUSHING SETTING STUFF—COLOURED SETTING—GAUGED SETTING—FINISHING ANGLES—SKIRTINGS—TWO-COAT WORK—STUCCO—OLD LONDON, COMMON, ROUGH, BASTARD, AND TROWELLED STUCCOS—COLOURED STUCCO—METHOD OF WORKING KEEN'S, PARIAN, AND MARTIN'S CEMENTS—WHITE CEMENT EFFLORESCENCE—CORNICE BRACKETS—CORNICES—CORINTHIAN ENTABLATURE AND CORNICE—MITRING—MITRE MOULD—FIXING ENRICHMENTS—MITRING ENRICHMENTS—PUGGING—SOUND CEILINGS—CRACKLED PLASTER WORK—REPAIRING PLASTER WORK—GAUGED WORK—JOIST LINES ON CEILINGS.

PLASTERING.—Plastering is the art of covering with or laying on plastic materials to make rough, uneven floors, walls, or ceilings straight, hard, and smooth. It also comprises the art of decorating surfaces with enrichments and mouldings. The word "plaster" (in Old English "plaister"), is Anglo-Saxon, and is derived from the Greek word *επιπλαστρον*, the Latin being *emplastrum*. This term is loosely employed to describe any form of mortar or plastic matter that can be spread on or around surfaces.

However humble the component parts of lime plaster, and cheap as it may seem beside marble and expensive woods, it still remains the most useful and fire-resisting material for encasing rough walls and ceilings. It has not been the fate of this simple, durable, and inexpensive material to escape the assaults which every good thing in this world must encounter at one time or another. It has been called unclean, but it is not so in itself. Like many another wholesome and useful medium, it can be badly made, and indifferently applied. This is due to the incapacity and greed of man, not to any inherent defects in itself. In spite of all that has been said against it, it remains the universal lining for dwellings throughout the civilised world. Wealth may encase walls and ceilings in decorative woods and marbles, but for the mass of mankind plaster must continue to be the simplest, most sanitary, least costly, and most enduring finish for homes. The health of the vast majority of mankind is therefore largely dependent upon the material used in its mixture, and the principles which shall actuate its employment. For all kinds of lime plastering it is of the utmost importance that the lime should be thoroughly slaked and mixed with the proper amount of good and clean sand, hair, and water, and the whole thoroughly incorporated and tempered, and allowed to mature before using. Success largely depends on the care bestowed on the materials and their manipulation.

PLASTIC TERMS.—Before describing the different phases of plastering, it will be well to define the various local technical plastering terms used. The names given to plasterers' tools, &c., have hitherto been rather vague—in fact, each district has had its own nomenclature. Strange to say, some districts have only a few general terms, many things being described as "this" or "that." It may be necessary, therefore, to point out a few instances of misapplication of terms.

"Hand floating" and "scouring" are frequently confounded, whereas they are altogether different. The technical term "hand floating" means to pass with a light irregular motion, while to "scour" is to rub hard, or to pass swiftly over. Bearing in mind that a hand float is used for other purposes, such as laying, setting stuff, &c., the term "hand floating" is somewhat conflicting. The term is also apt to be confounded with "floating," *i.e.*, the second coat of coarse stuff; also when floating with a floating rule. For these reasons, the term "scour," with its combinations, will be used in this work.

"Lime, sand, and hair" are sometimes termed "mortar," "lime and hair," also "coarse stuff." The latter term being the most general, will be used in this work. Where there is not a universally accepted trade term for certain tools and material, a suitable name will be employed, which it is hoped readers will accept for want of a better one. Plaster of Paris is abbreviated to "plaster," as it is generally termed in the trade. The following terms are generally accepted by architects and plasterers. Plastering with an admixture of lime, sand, hair, and water is termed "lime plastering." This kind of plastering is applied in one, two, or three coats, and the description of the work is generally distinguished by the number of coats applied. Three-coat work is usually described as "lath, plaster, float, and set," or "lath, lay, float, and set." Two-coat work as "lath, plaster, and set," or "lath, lay, and set"; and on brick walls as "lay and set." One-coat work as "lath and plaster," or "lath and lay"; and on brick walls as "render." "Lath and plaster, one coat," is the term used in the Government specifications. "Laying" or "laid" is simply laying a single coat of coarse stuff on lath-work, leaving a fairly smooth surface with the laying trowel. This one-coat work is the cheapest kind of plaster, used chiefly for pugging or deafening partitions, floors, roofs, &c.

In Ireland, ceiling work is usually described as "lathed, scratched, floated, and coated," while for walls it is described as "scratched, floated, and coated." There are several other modes of lime plastering which are somewhat vaguely termed "stuccos," but they are chiefly confined to London and surrounding districts.

THREE-COAT WORK.—Three-coat work is usually specified by architects for all good buildings, but sometimes two-coat work is specified for inferior rooms, closets, attics, or cellars in the same building. Three-coat work makes a straight, smooth, strong, and sanitary surface for walls and ceilings when properly executed. The following is the process for three-coat work, which consists of first-coating, floating, and setting.

FIRST-COATING.—"First-coating" is termed in London "pricking up," and in America "scratch coating." It is executed by laying and spreading a single coat of coarse stuff upon the walls and ceilings to form a foundation for the subsequent floating and setting coats. Coarse stuff for first-coating should be uniformly mixed or "knocked up," as commonly called. It should contain more hair than that used for floating, so as to obtain a strong binding key on the lath-work, and form a firm foundation for the floating coat. Coarse stuff may be tested by lifting some from the heap on the point of a trowel; if it is sufficiently haired and properly mixed, the stuff should cling to the trowel when held up, and the hairs should not be more than $\frac{1}{8}$ inch apart. It should be stiff enough to cling and hold up when laid, yet sufficiently soft and plastic to go through the interstices between the laths. Unless the stuff is made to the proper consistency, it will "drop"; that is, small patches, where the excess water accumulates, or at weak or too wide spaced laths, will fall soon after being laid.

When first-coating ceilings, the coarse stuff should be laid diagonally across the laths, a trowelful partly overlapping the previous one—the one binding the other. By laying the stuff

diagonally, the laths yield less, present a firmer surface, and are not so springy as when laid across or at right angles to them. Laying the stuff diagonally, and overlapping each trowelful, helps to retain the stuff in its place, which otherwise is apt to "drop." The stuff should be laid on with a full-sized laying trowel, using sufficient pressure to force it between the laths, and to go sufficiently through to form a rivet and lap or clinch on the upper sides of the lathing. The stuff should be laid fair and as uniform in thickness as possible. The thickness should not exceed $\frac{3}{8}$ inch, or be less than $\frac{1}{4}$ inch. If too thick, it tends to weigh down the lath-work, and is apt to crack; if too thin, the subsequent scratching is liable to cut the coat down or nearly to the laths, thus leaving a series of small detached pats which are unstable, and form a weak foundation for the floating coat, and are a source of cracks, and often the cause of the work falling when subjected to vibration. A thickness of $\frac{1}{2}$ inch gives the best results.

SCRATCHING.—Scratching is sometimes termed "scoring," also "keying." It is done with a wooden or iron scratch, which may have from one to five points. Scratching is scoring the surface of the first coat to obtain a key for the following coat. The first-coating should be allowed to stand for an hour or two to allow the stuff to get firm before proceeding with the scratching. If scratched while the stuff is soft, it is apt to drop; and unless a man is careful and light in his working, the scratch will go too deep, and weaken the body and the rivets of the first-coating. A wide scratch should be slightly angular at the points; if square, it should be drawn across the work in a slanting position, so as to give an undercut key. The whole of the surface should be uniformly scratched with a moderately sharp pointed scratch. The surface should be cross-scratched diagonally; square scratching cuts and weakens the rivets, especially when the scratch is drawn in the same line as the laths. Good work is generally scratched with a single lath. This, like other scratches, should be drawn in a slanting position, so as to give an undercut score. Single scratching is the best way for circular surfaces. First score it diagonally across the laths, and then crossways diagonally, keeping the scoring rather square than lozenge-shaped. When too pointed, the acute angles are liable to be broken when laying the floating coat. The scores should not be more than $1\frac{1}{4}$ inch from centre to centre, or less than 1 inch from centre to centre. Close scoring weakens the body of the first-coating, while wide scoring affords insufficient key. Scratching with a single lath requires thrice or even more time than if done with a four or five pointed scratch, but the work is stronger, as the body and the rivets of the first coating are not cut too deep or otherwise weakened. In some instances—such as a thin body of first-coating, already mentioned—the scoring is so deep that the body of the work is cut into a series of detached parts. By using a single lath or point the scoring is also more uniform, and better undercut, thus obtaining a stronger surface, and a better key for the floating coat. The additional time required for "single scratching" should be taken into consideration, and annotated and allowed for when making specifications, and estimating. All scratching should be done uniformly, taking care not to miss any parts, especially round door and window frames, wood grounds, or where there may be jarring or vibration. On the regular and proper scratching depends the key and stability of the succeeding coats. Scratching with the point of a trowel should not be permitted. The use of a trowel as a scratch is detrimental to the strength of the stuff and the key. The sharp edge of the trowel cuts the hair, and thus weakens the stuff. The smooth and thin plate of the trowel leaves a smooth and narrow key; the smooth side of the key presents no attachment for the second coat; while the deep part of the key is too narrow to receive its due portion of stuff to fill it up, thus leaving a space for contained air and a more or less hollow and unsound body.

RENDERING.—The first coat on brick, stone, or concrete walls is called rendering. Before

laying the coarse stuff, the superfluous mortar in the joints of brick or stone walls should be cleared off, as the mortar used by bricklayers and stonebuilders often contains live or imperfectly slaked lime, which in many instances is the cause of the plaster work blowing or scaling off. The walls, whether of brick, stone, or concrete, should be well swept with a hard coarse broom, and thoroughly wetted to correct the suction, which otherwise would absorb the requisite moisture from the coarse stuff, causing it to become inert and dry, consequently weak and non-adhesive. In some cases the joints of brick-work should be raked out, and the face of stone walls roughened by picking. The coarse stuff for rendering walls does not require so much hair, or to be used so stiff, as for coating lathwork. First-coating or rendering is generally looked upon as a simple process, but it should be carefully laid and scratched, as it is the foundation for the other work.

FLOATING.—Floating or second-coating—termed in Scotland “straightening,” and in America “browning”—is the laying of the second coat of coarse stuff on the first coat when dry, to form a straight surface for the finishing coat. If the first coat has been standing for some time, it should be well swept to clear off any dust that may have accumulated during the interval between the application of the coats. Where the coarse stuff is of a porous nature, a damp brush should be passed lightly over the first coat as the work proceeds, to prevent the moisture being sucked out of the second layer, which, if too dry, would tend to crack and fall away. The coarse stuff for floating should be used in a softer state than for first-coating, because when too stiff the extra pressure required for laying is apt to crack the first coat on lath work. It also goes more freely and firmly into the recesses of the scratching. [It may be here mentioned that a mortar called “Dogga” is extensively used in South Africa for plaster and building work. “Dogga” is the ground dug up and tempered with sand, about 2 to 1 for rendering and floating. Heavy ground requires more sand. Lime is very expensive in this country, and is only used for the best class of work.] Floating for lime plastering consists of four parts:— 1. Plumbing and levelling “screeds” to act as bearings for the floating rule and running mould; 2. Flanking or filling in the spaces between the screeds; 3. Scouring; 4. Keying the surface. These parts are performed as follows:—

SCREEDS.—In good work the wall screeds are plumbed and the ceiling screeds levelled. Wall screeds are plumbed by forming “dots” at the top and bottom of the internal and external wall angles. If there are wood grounds to receive wood skirtings, they are used instead of bottom dots. The dots are made by driving two nails through the first coat into the studs or joints of the wall, allowing them to project about $\frac{1}{2}$ inch beyond the face of the first coat. The position of the top nail should be immediately beneath the cornice bracket. If there is no bracket, the depth of the cornice should be allowed for. The bottom nail is placed in a line with the upper member of the skirting moulding. The nails should be placed perpendicular with each other, otherwise the plumb-bob-line will not work in unison with the gauges. The dots are plumbed by means of a plumb-rule. If the walls are too high for an ordinary sized plumb-rule to be used, a chalk-line with a plumb-bob attached, and two wooden gauges, will be required. Illustration No. 13 shows the nails, gauges, and plumb-bob-line in position. B, B are the nails in the wall, one just below the cornice bracket, and the other a little above the floor line; A, A are the gauges with the line hanging fair with their shoulders, being the correct position when the nails are plumb. The gauges are generally cut out of a strong lath. They must be made exactly to the same length. The plasterer at the top holds the end of one gauge on the top nail, with the chalk-line resting on the shoulder of the gauge, while the plasterer at the bottom holds the other gauge on the bottom nail with one hand, and guides the plumb-bob with the other. The nails are now driven in as required until they are plumb. Care must be taken to allow for a fair thickness for the floating coat. This

should not be more than $\frac{3}{4}$ inch, or less than $\frac{1}{2}$ inch. When working from a wood ground, the top dots should be kept a little inside the plumb-line, to allow for the traversing of the cornice screed, because this screed and the gathering at the bottom of the cornice are apt to throw the wall out of plumb, unless cut off or allowed for. The dots are completed by laying narrow strips of gauged coarse stuff close up to and in a vertical line with the top and bottom nails; the floating rule is then applied, and the stuff worked down until flush with the nails. The dots should not be wider than the width of the floating rule, as the rule when bearing on the nails can only be worked with an up-and-down motion, taking in only its own width. The length of the dots may vary from 5 to 7 inches, according to the bearings required for the cornice and skirting running moulds. Narrow screeds are easier, quicker, and truer made than wide screeds; the latter are apt to have a more or less wavy surface. This applies more especially to "laid screeds," that is, screeds that are simply laid and ruled off without dots or other bearings.

Lath dots are sometimes used instead of nail dots, they are generally used on ceilings and lathed partitions; they are not so liable to crack the first coat as nails. They are formed by laying a strip of coarse stuff and placing thereon a straight lath about 6 inches long, and then applying a plumb-rule or a plumb-bob-line as described for the nail dots. The lath gives strength and resistance while working the floating rule. After the screeds are finished, the laths are taken out and the spaces made good. Having finished all the top and bottom dots, the top and bottom longitudinal spaces in a line with the dots, or, in other words, the screeds, are laid with coarse stuff. The long floating rule is then applied, bearing on the dots and working up and down in a slanting position, a plasterer working the rule at each end, and working together, so as to keep the rule square on edge and uniformly level. Any surplus stuff is taken off the rule and applied to make up any hollow parts in the screed, or returned to the gauge board, as the case may be. If the screeds are extra long, another man (sometimes more) is required to work at the centre of the rule, also clean the surplus stuff off, and make up any deficiencies in the screed. After the screeds are finished, the nails must be extracted to avoid rust discolouring the finishing coat. Large surfaces on walls or ceilings should be divided into bays by narrow screeds placed from 6 to 9 feet apart. This affords more freedom and regularity for laying and ruling off. Gauged coarse stuff is sometimes used for the main screed, *i.e.*, the wall and ceiling screeds on which the cornice is run. In this case the screeds are finished smooth, or so that they only require a very thin or filling-up coat of gauged putty for the cornice screeds. The splayed edges of screeds, especially gauged screeds, should be cut square. A splayed edge being generally smooth, affords little or no key, and also being unequal in thickness, makes a bad joint for the floating coat. If there are any breaks in the room, the screeds must be set off square from the side walls, and the projections at each angle of the breast made equal. The sides are best squared with a large wooden square, and the projections regulated with a gauge.

FLANKING.—Flanking or filling in consists of laying the intervening spaces between the screeds with coarse stuff, and then ruling the surface straight and flush with the screeds, with a

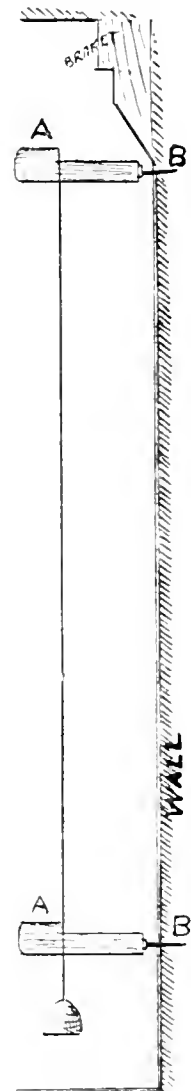

No. 13.—WALL PLUMBING.

floating rule. Two squads of men, two or three in each squad, are required for this purpose—one squad on the floor, and the other on the scaffold. If the height of the room necessitates more than one scaffold, an additional squad is required for each intervening scaffold. In the latter case, the distance between the top and bottom screeds would be too great to allow a floating rule to be conveniently worked. To overcome this difficulty, intermediate screeds must be made at convenient distances. This is done by stretching a chalk-line from the top to the bottom screed, and then forming dots flush with the line, and laying the screeds as previously described. The coarse stuff for flanking should be laid upwards, and in an angular line. This plan is not so apt to spring the laths or crack the key at the deepest, which is the thinnest part of the first coat, as if laid across the laths. After a bay is laid, the surface is straightened with a floating rule. A plasterer at the top and one at the bottom works the rule together uniformly up and down with a cutting motion, and keeping it in a slightly angular position, so that any surplus stuff may not fall on the man below. A rule should not be worked on either of its face edges, as by so doing the face becomes round and uneven, and conducive of unequal screeds. The filling in and ruling off is continued until all the walls are completed. When elaborate ceilings have to be done, involving the expenditure of much time, the top longitudinal screeds are only formed, and the floating of the walls left until three or four days before the setting can be begun, as the setting coat made from some limes adheres better when the floating coat is partly green, or at least not bone dry. As previously mentioned, the whole process of preparing lime plaster and laying it on the walls in thin coats, with a considerable space of time between the coatings, is conducive to the ultimate hardness of the whole, the lime being first slaked and then scoured, all this time being exposed to the carbonic acid of the atmosphere. Again, each coat is long exposed to the same influence before being covered with the next, thus enabling each coat to harden by a natural process before the following coat is laid. All things being equal, it is advisable to allow each coat to stand as long as possible before proceeding with the next. Where the wall surface is irregular, causing extra thick parts in the floating coat, the hollow parts should be rendered or "dubbed out," and the surface scratched before laying the floating coat. The dots for the ceiling screeds are formed close to the cornice bracket. If there are no brackets, the projection of the cornice must be allowed for. Lath dots are best for ceiling screeds. They are formed at all the angles, and made level all round the ceiling. This is done with the aid of a "parallel ceiling rule." When all the dots are made, the screeds are finished, and the surface flanked in as already described.

For common work, the wall screeds are seldom plumbed; but if there are breaks in the room, the external angles, which are more noticeable, should always be plumbed. For this class of work two men generally work together. Working from the floor upwards, one man lays a coat of coarse stuff about 7 inches wide, and as high as he can conveniently reach up on both sides of the internal angles; his colleague follows on with a floating rule and rules them straight. Before finishing the screed, the rule is applied on the portion done, and gradually moved up until one end reaches the cornice line, to see if there is a sufficient thickness for the upper part of the screed. The space between the first-coating and the face of the rule shows the thickness available for the floating coat. The desired thickness is obtained by laying more stuff on the screed, or working it down, as the case may be. As the floating rule cannot be worked close up to the angle, a seam of coarse stuff is formed in the angle.

To allow for shrinkage, and to obtain a firm and square angle, the seams are left until all the floating is done, after which they are cut off square and flush with the floating. This is done with a laying trowel, working it on its flat on the firm floating. Any defects in the angles are made

good when scouring the floating. After the vertical angle screeds are firm, horizontal screeds are laid at the highest convenient line, and ruled with a floating rule bearing on the vertical screeds. The intervening spaces are then flanked in by laying with coarse stuff until flush with the screeds. The surface is sometimes ruled fair with a floating rule, but more often straightened with a darby. After the scaffold is erected, the top portions of the vertical screeds are laid and ruled with a floating rule, working it so as to bear on the lower part of the screed previously made, which gives a bearing and guide for the rule. After allowing for the depth of the cornice if not bracketed, the top horizontal screed is then laid and ruled with a floating rule bearing on the vertical screeds. The intervening spaces are then filled in with coarse stuff, and ruled in or darbied as previously described. The ceiling screeds are made close to the cornice bracket, or if not bracketed, in a line with the outer member of the intended cornice. A screed is first made at each of the long sides of the ceiling, and when firm the end screeds are laid and ruled, using the long screeds as bearings for the floating rule. If the scaffold is in position before the floating is commenced, the vertical screeds should be formed in one operation. A plasterer on the floor lays the lower part of the screed, while his partner on the scaffold lays the upper part, after which both work the floating rule together in their respective positions. Where practicable all screeds should be finished in one operation. In the event of a screed being too long for an ordinary sized rule to take in the whole length and work it in one operation, the screed can be made straight by working the rule backwards and forwards from end to end, and testing the straightness by applying the rule on various parts of the screed. The straightness is further proved by lightly stretching a chalk-line from one end to the other end of the screed. After the screeds are firm, the main portion of the ceiling is laid with coarse stuff flush with the screeds, and then made fair with a darby.

When floating large surfaces with a darby, it should be worked in all directions—longwise, crosswise, and diagonally—and finishing with a circular motion. For ordinary work a darby is an excellent tool for straightening large surfaces of floating and setting. It also forms a pleasing and easy surface on circular work. For basement and attic rooms a darby properly manipulated will form fairly straight screeds as well as the main surfaces. When floating large ceiling or wall surfaces for plain work, or where it is not necessary that they should be perfectly straight, involving additional time and material, a hollow surface is preferable to a round surface. A hollow surface is not so noticeable, and is less objectionable to the eye than a round surface. It will be understood that a hollow surface, to be pleasing to the eye if noticed, should flow gradually and regularly from the screeds to the centre of the surface, and not suddenly or in wavy parts or patches.

There is an inferior kind of floating practised by piece-workers, in some districts, for cottage work, and even in some of the modern jerry-built villas. This is executed by floating direct from the walls in one coat. The surface is sometimes dry-scoured with a "nail hand float," water and proper scouring being unknown in this class of so-called plastering. The ceilings are simply laid with coarse stuff, and the ridges and smooth surface left by the trowel are worked down and roughened by a few rubs with a hand float. This porous and cracked shell is finished with setting stuff, gauged with just as much plaster as will hold the materials together for the time being. The minimum of (or possibly less) trowelling is attempted; a stock brush being found a more easy and speedy tool than a trowel for finishing. The brush is made to perform the trowelling and brushing off in one operation. This shoddy work is unsafe and unsanitary, and ought not to be tolerated.

SCOURING COARSE STUFF.—Scouring floated coarse stuff is of great importance. It not only consolidates and hardens the surface, but also prevents cracks in its own body and the

subsequent setting coat. For these reasons it should be well and sufficiently done. The straightened coarse stuff should be allowed to stand to permit of shrinkage, evaporation of surface moisture, and a firm surface, before proceeding with the scouring. Working a hand float on a soft surface tends to form "water blubs" and hollow parts. When the surface is firm, but not dry, the work is fit to scour. This is done by the plasterer having a hand float in one hand, and a stock brush in the other, with which he sprinkles water on the surface, and vigorously applies the float with a rapid circular motion, using a little soft stuff to fill up any small holes or inequalities that may have been left after the floating rule. Care must be taken that no part is missed or less scoured, and that the whole surface is thoroughly and uniformly scoured. The floating should be scoured twice, or for best work three times, and allowing the work to stand from three to five hours, according to the state of the atmosphere, between the first and second scouring, and one day between the second and third scouring. The final scouring should be continued until there is little or no moisture left on the surface. To obtain the same strength and solidity, all other things being equal, coarse stuff composed with a weak lime, or containing inferior or an excess of sand, or having insufficient hair, or sparsely tempered and used in an over-soft condition, requires a greater amount of scouring than coarse stuff which is composed with a strong lime, or containing good sand, and in due proportion, or with an ample quantity of hair, or well tempered, and used in a moderately stiff, yet plastic condition. Even with extra scouring, the ultimate strength of inferior coarse stuff is remote and doubtful. This simple matter is a witness to the fact that inferior or insufficient materials require more labour than good and sufficient materials, and that the results are somewhat vague and often unsatisfactory.

KEYING.—All plastic materials have great adhesive powers, especially to each other. Yet when laying a thin body of fine material on a coarse material which has a more or less smooth, dry, and absorptive surface, such as laying setting stuff on floated coarse stuff, the adhesion is partly nullified. Portland cement, or hydraulic limes which set nearly as soon as laid, require no scouring, and being left from the floating rule with an open grained or rough surface, a natural key is obtained for the final coat; but coarse stuff, which only sets or becomes hard by evaporation of its moisture, must be scoured to consolidate the yielding and soft body. Scouring leaves a close-grained and somewhat smooth surface, offering little or no key to the setting coat. The floated coat being often dry before the setting coat is applied, the suction varies greatly; sometimes it is regular, at other times it occurs in patches. Sometimes the suction is so excessive that the setting stuff dries up and peels as soon as laid, and in other instances the reverse occurs, there being no suction at all. In the latter case the setting stuff runs downwards in the form of globules, or in rivulets. These defects may to a certain extent be corrected by laying the setting stuff while the floating is still green, or by saturating the surface if the floating is dry. Yet to obtain permanent cohesion in the two coats, it is necessary to key or roughen the surface. This is best done by brushing the surface as soon as scoured with a stiff whalebone broom, or with a wire brush. A common plan is to dry scour with a "nail float," *i.e.*, a hand float with the point of a nail projecting about $\frac{1}{2}$ inch beyond the sole of the float. When this method is employed, the float should be worked in a close circular motion, so as to leave a series of close and irregular indents. The usual and careless way of working the float in a wide circular motion leaves the indents too wide apart to give a sound and uniform key; indeed, this method is of little service. A new tool for keying coarse stuff has been recently introduced in London. This is called a "devil," and is similar to the nail float, with the exception that there are four nail points projecting on the sole, one of which is placed about $1\frac{1}{2}$ inches from each angle. The process of keying the

coarse stuff with this is termed "devilling." The work is more speedily and better done with the "devil" than with the nail float.

After the floating is finished, the next part of interior plaster work is the running of the cornice, and then finishing the ceiling and walls; but in order to continue the methods of setting, the running of the cornice, &c., are described in a subsequent chapter, and the setting and other parts of wall work are first described, as follows:—

SETTING.—Setting is the laying and finishing the final coat on floating. Setting in Scotland is termed "finishing," and in America "hard finish" or "putty coat." In the best work great skill and care is required to make the surfaces perfectly true and uniform in colour, smoothness, and hardness. The material for three-coat work is generally known as "setting stuff." The mode of making is described in the chapter on "Materials." Setting stuff should not be applied until the floating is quite firm and nearly dry, to allow for any contraction that may take place in the floating. If the floating should become quite dry during the time required for cornice and ceiling work, or where subjected to strong winds or a warm atmosphere, it should be well wetted a day or two before the setting coat is commenced. This prevents the too rapid absorption of moisture from the setting coat, and gives a closer union of the floating and setting coats. Before wetting copiously, a small portion of the floating should be tested with a wet brush to ascertain the degree of suction. In some floating there is no suction, or at least there is none until the surface has been dampened, and the glaze and sometimes grease has been washed off. Glaze is caused by slightly hydraulic lime, also by insufficient scouring. Glaze is more noticeable on first-coating which has been left smooth by the laying trowel. Grease occurs through friction, also dirt where the float is left long exposed. These matters of excessive and non-suction, dry, glazed, or greasy surface, either singly or in combination, also smooth or unkeyed floating, are the cause of cracked or scaly setting, which one sees more or less in a plaster career. It is therefore absolutely necessary, to ensure perfect cohesion of the two coats, that the floated surface should be uniformly keyed, clean, and damp, before the setting coat is laid. Setting consists of laying the stuff, scouring, trowelling, and brushing the surface.

LAYING SETTING STUFF.—The setting stuff is laid in two coats, the second following immediately upon the first. The laying is best done with a skimming float, which leaves the face of the first coat rougher to receive the second than if done by a laying trowel, which leaves it smooth. The second coat should also be laid with a skimming float, which leaves a more open grain for the purpose of scouring. When laying setting stuff, some men take a trowelful or skimming-floatful off the hawk, and stoop to spread the stuff from bottom to top with an upward motion, laying the joint with a return downward motion; but a smart man can take a trowelful or floatful of stuff and spread it with a downward motion from top to bottom, and lay the joint with the return motion, thus saving one stoop in each spread or floatful. This is similar to laying setting stuff on a ceiling. A man who has a thorough command of the trowel hand always lays the stuff in a long even spread outward, and lays the joint with the inward return motion. After one side or bay of a wall is laid, the surface is then scoured, trowelled, and brushed.

SCOURING SETTING STUFF.—The importance of good and sufficient scouring of setting stuff with water cannot be too strongly insisted upon. The scouring and the water combined consolidate, harden, and render the surface of a uniform texture and evenness. The work must be well and thoroughly scoured, twice with water and an ordinary hand float, and finally with a cross-grained float. The hand float is worked with a short and rapid circular motion, and sprinkling water uniformly with a stock brush until the surface is uniform in moisture and texture. After a rest to

allow the stuff to shrink, the scouring is repeated, and then it is ready for the final scouring. This is best done with a cross-grained hand float, which, having sharp square edges, cuts off all ridges and leaves the setting with a uniform and even surface that cannot be so quickly or as well done with an ordinary hand float. Water is more sparingly used for the final scouring, using only as much as will moisten the surface and allow the float to work freely. The scouring is continued until a dense, even, and close-grained surface is obtained for the trowelling.

TROWELLING AND BRUSHING SETTING STUFF.—Trowelling setting stuff is best done by the use of a half-worn trowel (commonly called a "polisher", the edges of which should be perfectly straight and parallel. Some men use an old and worn trowel with the point narrower than the heel. This shape of trowel should never be used for high-class work, since not being parallel, the pressure when trowelling is not equal, and the heel or widest part is apt to score the surface of the setting. The trowel and the water should be perfectly clean to prevent any discoloration. The trowelling should be done by one man following up the other who is finishing the final scouring. This is done by the plasterer having a polishing trowel in one hand, and a stock brush in the other, with which he sprinkles water on the surface, and works the trowel in long and vigorous strokes, first downwards and upwards, and then crossways or diagonally. This is repeated, using the water more sparingly, and finishing or "trowelling off" with an up and down motion, and leaving the surface free from "fat" or "glut." The work is then brushed with a wet stock brush, first up and down, then crossways, afterwards up and down a second time. The brush is then semi-dried by violent shaking, or rubbing on a clean board, the work again being brushed as before and finished perpendicular.

GENERAL REMARKS ON SETTING.—When the work is required for painting, the setting stuff is laid on in the form of screeds, and when firm the intervening spaces are laid flush with the screeds, and the whole surface ruled fair with a floating rule. Should there be any hollow or soft places the latter being liable to shrink, they are filled in with more setting stuff and ruled over again. This is repeated until the whole surface is true and uniform in thickness and firmness. The whole surface can then be scoured, trowelled, and brushed in one operation. This method has the advantage of saving joints at the connections between the height a man can lay and finish the setting stuff.

Joints, unless carefully done, are an eyesore, as they are liable to be more or less discoloured and uneven on the surface. The best method for making good joints in setting stuff, where it is inconvenient to lay and finish the whole surface in one operation, is to leave the edge of the joint untrowelled, leaving a scoured margin, so that the adjoining portion can be laid and scoured without spoiling the trowelling of the first portion. For instance, when setting the walls of a room, one scaffold high, the top parts are laid down to the level of the scaffold, or as far as convenient, and the surface scoured and trowelled. The latter must not extend to the end of the scoured part, so as to leave an untrowelled margin about 4 or 5 inches wide until the scaffold is struck. After the scaffold is removed, the lower portions of the walls are laid flush with the untrowelled margin, and then the surface is scoured as before, always going well over the joint. The surface is then finally scoured with a cross-grained float, taking care to moisten and rescour the untrowelled margin to render the whole of the scoured surface equal in texture and moisture for trowelling. The surface is then trowelled and brushed, as already described, taking care to go over the trowelled and brushed joint. By this method no joints are visible, and an even surface is obtained. Where the suction is slow or irregular, causing the setting stuff to run or be soft in places, float the surface with a darby until sufficiently fair and firm to be scoured. A darby is very useful for forming a fair surface on setting

stuff before scouring and trowelling. It forms the next best surface to a ruled surface. A darbied surface is better and truer than a laid surface.

No more setting stuff should be laid than can be conveniently finished in one operation or day. Where practical, one side of a wall should be finished in one piece, and sufficient men should be employed thereon. If the room is not too high, one man or set of men may do the upper part, while another man or set of men does the lower part. The joints are then made while the setting stuff is green. In high rooms, several sets of men work together on different scaffolds, each about 6 feet 2 inches apart. All angles should be ruled in with a long floating rule. External angles are sometimes formed by nailing a running rule or a straight-edge plumb on one side of the wall, to act as a guide, but external angles are generally finished with a run cement bead or an arris. An average thickness of $\frac{1}{2}$ inch of setting coat when finished gives the best result. It should not exceed $\frac{3}{16}$ inch, or be less than $\frac{1}{16}$ inch in thickness. If too thick, it is liable to crack and flake; if too thin, it is liable to peel. Where extra strength, and cohesion between the floating and setting coats is desirable, the first coat of the setting has a little white hair mixed with it. White hair does not show through the last coat.

COMMON SETTING.—Common setting for wall and ceilings is generally used for second-class work. It is done by laying one coat of setting stuff with a skimming float, and scouring and trowelling once and brushing twice. Where the floating cracks by contraction, or by using insufficient hair in the coarse stuff, or by want of scouring, or where the work is green, the cracks are knocked in with a hammer. The indents are then filled up with gauged setting stuff, and the whole surface laid with a coat of this material, on which a coat of neat setting stuff is laid, scoured, trowelled, and brushed in the usual way.

SKIMMING.—Skimming is an inferior class of setting, and is only used for the most common work. It is done by laying a coat of fast-setting stuff with a laying trowel. The stuff is skimmed over the floating as thin as possible, using only as much stuff as will whiten and smooth the floating surface. It is trowelled once, and brushed as soon as laid.

COLOURED SETTING.—A beautiful colour and brilliant finish for walls is obtained by mixing an equal quantity of sifted marble dust with setting stuff, and using this "marble setting stuff" as a final coat. Ordinary setting stuff is greatly improved by substituting a part of marble, or alabaster, or gypsum dust, equal in bulk to half the sand generally used. The marble dust should be as coarse as the sand. Crushed spar is sometimes used in setting stuff to obtain a sparkling surface. Barytes, scoria, and slag are sometimes used as a substitute for sand, for colouring and hardening purposes. Brick dust is also used for colouring, and weather and heat resisting purposes. Ground glass, as used by Indian plasterers, gives a sparkling surface. Setting stuff may also be coloured with the same materials as described for coloured stucco. Where marble dust or any of the above materials are used, they should not be added until the setting stuff is required for immediate use. They should not be used until perfect amalgamation has ensued.

GAUGED SETTING.—Gauged setting is used where the floating is soft, or where the work is required for immediate use, and also for finishing gauged floating. This is performed by one man laying the gauged stuff with a skimming float, while his partner follows up with a darby to lay the surface fair. Another batch of setting stuff is then gauged, and one man lays a thin coat with a trowel, and the other man follows immediately and trowels the work before it is set. The surface is finished by brushing with a semi-wet brush. Gauged setting should never be scoured unless the size water is used in the gauge to delay the setting, as it will kill the plaster and render the stuff useless. Even if size water is used, the scouring must be slightly and quickly done. If a gauged

surface is desirable, a fair and hard surface is obtained by simply darbying and trowelling as soon as laid.

GAUGED PUTTY SET.—Ceilings are sometimes set with gauged putty. This is best done by first laying a "scratch coat" of gauged putty with a skimming float, and then passing a hand float over the surface before the stuff is set to lay down any ridges, and make the surface more even to receive the second coat. This is laid with a laying trowel, and then trowelled before the stuff is set. The surface is then finished with a semi-wet brush. Trowelling after the stuff is set, or even has begun to set, kills the stuff, and causes it to peel. A little washed sand added to the putty makes a stronger surface, and not so apt to peel.

PUTTY SET.—In some districts common ceilings are finished with a thin coat of neat lime putty; but unless the putty is made from grey limestone, or is of a hydraulic nature, the work is more or less weak, and in most cases practically useless.

INTERNAL ANGLES.—The setting coat of internal angles on room walls should be ruled fair and then cleaned out with a feather-edged rule. Before scouring the setting stuff, the angles should be squared and made straight with an angle float. The angle float is a tool now unfortunately seldom used, but it is the best tool for making a true angle. In the absence of an angle float, the angle should be made fair and square with a cross-grained float, and finished with a margin trowel or the heel of a laying trowel. The common way, used in some districts, of finishing an angle with a gauging or pointed trowel, should not be encouraged, as it is impossible to make a true angle with a tool of this shape.

EXTERNAL ANGLES.—The external angles of room walls and windows are generally finished with a bead, but in some instances with a plain arris, splay, or small moulding. They are formed with Parian or other white cement, and usually run after the floating is done. The floating should be cut square at each side, and down to the brick or lath work. After dusting and wetting the foundation, a running rule is fixed on one side, and then the bead or arris is run. The run edges form bearings for the setting coat. A run arris is more speedily done and truer than a ruled and trowelled arris. In some districts wooden beads are used for external angles. The floating is cut down at each side of the bead, to allow the quirks to be formed when the setting coat is laid. When the setting coat is trowelled, the quirks are formed by applying a large-headed nail on the bead, and drawing it up and down to cut the stuff out. They are then finished by working a laying trowel up and down until smooth and true, and afterwards wet-brushed. The bead quirks are sometimes cut out by aid of a wooden template, also by laying a straight-edge on the work as a guide for cutting the stuff out. They are then finished with a trowel and brush, as already described.

SKIRTINGS.—Skirtings are sometimes formed in wood, but are often formed in cement. Cement skirtings are far more sanitary than wood skirting, as the former connects the wall and the floor in one solid fire-resisting and vermin-proof body, whereas wood skirtings, owing to their nature and construction, afford a ready harbour for vermin, and offer but little or no resistance to damp and fire—indeed, their hollow formation presents a vent in the case of fire. Parian or other white cement is generally used where a fine finish is desirable, and Portland cement where the work is exposed to wet and hard wear. Skirtings are generally run by first roughing out the plinth by aid of a gauge rule bearing on the floating, and then forming a running screed, and fixing a running rule on the plinth. The skirting moulding is then run in the usual way, after which the running rules are taken off, and the plinth set. The mould plate should be cut to form about 1 inch of the top part of the plinth, to form the arris, and a bearing when setting the plinth. The annexed

illustration (No. 14) shows the method of forming the core and plinth, and running the moulding. Fig. 1 shows the gauge rule (G) in position to form the core (C). The gauge rule is from 3 feet to 4 feet in length. The plinth is formed by first roughing out with gauged stuff, and then drawing the gauge rule along the floating to form the core, and a fair surface for the running screed. Fig. 2 shows a section of the running mould (M) and the running rule (R) fixed on the plinth or core (C).

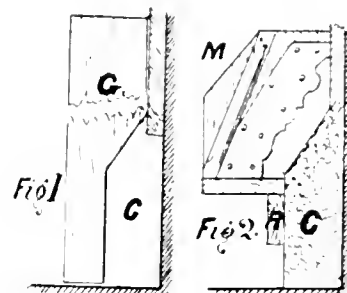

NO. 14.—SKIRTING FORMATION.

TWO-COAT WORK.—This is a cheap method of plastering, and only used for common work, such as the walls of factories, warehouses, &c. It is performed by laying one coat of coarse stuff and then forming the surface fair with a darby, after which it is scoured once. It is then finished by laying a thin coat of setting stuff over the surface, and then trowelling once and brushing twice wet and once semi-wet.

ONE-AND-A-HALF-COAT WORK.—This is sometimes termed “coat-and-half work.” It is a species of two-coat work—in fact, it is so termed in some districts. It is done by first laying a coat of coarse stuff fair, and then scratching the surface with a coarse broom, after which a thin coat of extra fat coarse stuff is laid, straightened with a darby, and then trowelled and brushed. The second coat must be laid while the first is green. This permits the two coats to amalgamate better, and the surface to be more easily worked and finished.

STUCCO.—Stucco is an Italian term usually applied in Italy to a superior species of external plastering. According to Vasari, Primaticcio “did the first stucchi ever executed in France, and also the first frescos.” In England stucco is a somewhat indefinite term, used loosely for various plastic mixtures in whose composition lime, plaster, or cements enter. Hydraulic lime was formerly used for external stucco. Roman cement was extensively used for stucco fronts during the first half of the present century. Selenitic lime has sometimes been used for a similar purpose. These materials are now entirely superseded by Portland cement. The adoption in England of stucco externally to give brick houses the appearance of stone is due to Robert Adam. Its plastic nature enables it to adapt itself to most architectural purposes with very considerable decorative effects. The more general use of stone and the improvements in terra-cotta have so greatly decreased the use of stucco for fronts, that stucco has become a synonym for a sham, and its real usefulness for certain works and places has been greatly overlooked. When properly prepared and manipulated it makes excellent work, and in the near future a large use may be predicted for its use.

OLD STUCCO.—It has already been shown that stucco was largely employed by the ancients for plain and decorative purposes. The temple of Apollo at Delos, and even the first Parthenon under the ægis of Pallas herself, were plastered with stucco. Vitruvius in his seventh book mentions stucco under the name of *opus albarium*, sometimes written *album opus*. *Tectorium opus* (from *tector*, a plasterer) was a name given by the Romans to a mortar used for plastering. According to Vitruvius, Palladius, and Pliny, there seems to have been a difference between *tectorium opus* and that called *albarium* or *album opus*. Vitruvius says *tectorium* was composed of three coats of lime and sand, and three of lime and marble. According to Winckelman, the united thickness of these coats was not more than 1 inch. The first coat was of common, but old lime and sand, and when it was nearly dry a second coat of lime was laid, and on this drying a third coat of fine lime was laid and made fair. The work was then laid with other two coats of lime and marble,

and finished with a coat of fine marble powder. The marble mortar was frequently beaten to render it tough and yet plastic, and it was judged fit for use when it would no longer stick to the trowel. When the lime mortar was dry, the marble mortar was laid, each successive coat of marble mortar being laid before the preceding one was quite dry. The first coat of marble mortar was composed of coarse ground marble and old lime, the second of fine ground marble and lime, the finishing coat being neat marble ground to a fine powder, and laid before the second coat was dry, and worked with a wood float until the surface was consolidated and straight. When dry it was polished with lime and chalk or with marble until like marble itself. Old stucco has been found so hard and highly polished that it has been used for looking-glasses and tables. In time it became hard and not liable to crack, and formed an excellent ground for the painting with which the Greeks and Romans decorated the walls of their houses. According to Vitruvius, this painted plaster could be detached without fear of injury, and detached slabs were carried to Italy and inserted in the walls of Roman houses. To prevent the cracking of the work done on wood, it was strengthened by two layers of reeds, one layer crossing the other at right angles. To ensure dryness, and allow the plaster to attain its proper hardness, the walls were perforated at suitable places. The *tectorium* was then decorated with brilliant colours, which were applied on the last coat while it was fresh; and to heighten the brilliancy and endurance of the colours the surface was rubbed over with wax and pure oil. When marble was used with lime in place of sand it was termed *martmoratum*. The *albarium* or *album opus* was what we term plaster or stucco. The Greeks named *tectorium* and *albarium*, *koniama* and *kalachrisis*.

Slabs of *tectorium* from the walls of Pompeii and Herculaneum are now in the Museum of Portici, and specimens are also in the South Kensington Museum. In the Museum of Practical Geology, London, there are several pieces of old plaster, taken from the ruins of Pompeii, some of which show that the decorative colours were not applied *al fresco*, but subsequently to the polishing. Stucco and plaster are really two very different things. Stucco has for its base carbonate of lime, generally burnt limestone or chalk, with which putty lime and coarse stuff is mixed with sand, &c., and used for plastering walls and ceilings. Plaster has for its base sulphate of lime, being made from gypsum, and is used for cast work and gauging with lime putty, &c. The best kinds of stucco will resist the action of weather, and can be washed. Plaster, unless specially prepared or indurated, perishes by exposure, at least in our English climate, and cannot be washed. Stucco is a superior kind of mortar, and it may be used for plastering or for modelling. The admixture of various materials with lime and with plaster to form stucco is referred to by many ancient writers. Pliny mentions fig juice as being mixed with stucco. The Egyptians mixed mud from the Nile with plaster for some of their work. Elm bark and hot barley water was mixed with the stucco for Justinian's Church of the Baptist, Constantinople. We find bullocks' blood employed for this purpose as well in mortar for Rochester Cathedral in the latter part of the ninth century. Bishop Gundulph (1077-1108) is stated to have mixed blood with lime to make it hard. Hot wax mixed with lime was used at Rockingham Castle in 1280. White of eggs and strong wort of malt were mixed with the lime used for Queen Eleanor's Cross at Charing Cross in 1300. Pitch and wax were mixed with the lime used for Edward II.'s works at Westminster in 1324. Mediæval builders habitually used beer, eggs, milk, sugar, gluten, &c., for mixing with mortar for cathedrals. Frequent entries found in the archives prove this. One reads, "For beer to mix with the mortar." Bess of Hardwick's masons used beer in their mortar, having to melt it in the cold winter of her death. Old plaster is found to have rye straw mixed with it for binding, and was very strong. A brown substance somewhat like plaster, but full of fibre, was in use in the sixteenth century. The accounts for the repair of the

steeple of Newark Church in 1571 contain an entry, "6 strike of malt to make mortar to blend with ye lyme and temper the same, and 350 eggs to mix with it." During the building of the Duke of Devonshire's house at Chiswick, the exterior of which was plastered with stucco, the surrounding district was impoverished for eggs and butter-milk to mix with the stucco. Peter le Neve's mention of rye dough stands not alone, as Sir Christopher Wren's "Parentalia" 1750 records the use of "marble meal" as the old and still the modern way of stucco work in Italy. "Marble meal" simply meant marble dust ground as fine as meal. This dust was used for fine work. Sugar and the gluten of rice are used in Ceylon and India. The Chinese use a rich unctuous earth in combination with lime. In some parts of France urine was used with plaster in the sixteenth century. Nearly all these admixtures are to retard the setting, to allow more time for the manipulation of the stuccos. Some are to accelerate the setting, and some are to increase their ultimate hardness.

Many of the ancient buildings in various parts of the universe, which were built of mud, clay, or sun-dried bricks, had their surfaces decorated with hand-wrought stucco. During explorations in Peru, South America, Dr Le Plongeon found some interesting specimens of ancient plaster work in a number of the ruins of the early Peruvian houses and cities, which date back to remote antiquity. At Chenni Concha he found the fragments of some ancient ornamental stucco on the adobé (or clay-built) walls, covered with bas-relief decorative designs, while the material is after many centuries still in good preservation. The design and the execution are of considerable merit, and it seems wonderful that a people ordinarily held to be but little better than savages could have conceived ornamentations so æsthetic, and have executed them with such high technical ability.

Cav. M. Guggenheim, who has had much stucco work done in the Palazzo Papadopoli and elsewhere, gives the following formula for the *stucco duro* which is still used in Venice:—It is old stone lime, slaked for three years at least, mixed with Carrara marble dust, ground as fine as flour, into the consistency of paste. This of course is for the finishing coat, the rough modelling being executed with a coarser material. Italian stucco is described in Chapter XVI.

LONDON STUCCOS.—There are four kinds of so-called stuccos which are used in London and the South of England. They are known as common, rough, bastard, and trowelled. The methods of working these species of plastering are embodied in the description of three-coat work—in fact the only difference between these stuccos and three-coat work lies in the setting coat, the first-coating and floating being the same for all. Some of the above terms are now only used by workmen, and the use of stuccos is to a great extent superseded by Portland cement for exterior work, and Parian and other white cements for interior work. The following is a summary of the materials and methods used for the various stuccos.

COMMON STUCCO.—Common stucco was principally used for exterior work. It is composed of 3 parts of coarse sharp sand to 1 of hydraulic or grey lime, to which a small portion of hair is added. It is laid in a similar way to ordinary rendering in one coat, and the surface finished with a hand float.

ROUGH STUCCO.—This is generally used for plastering churches, corridors, and entrance halls to imitate stone. The work is floated with ordinary coarse stuff, and then set with stuff composed of 3 parts of washed sharp sand and 2 of grey lime putty, not chalk. This is laid with a trowel, and then ruled in with a straight-edge until the surface is full and fair. After this it is scoured with an ordinary hand float, and finished with a "felt float," not to raise the grit, but to keep it down. The felt float is an ordinary hand float with an unplanned sole, on which a felt sole, about $\frac{1}{4}$ inch thick, is fixed with gauged plaster. This tool before using generally requires to be

rubbed on a straight stone to obtain a uniform face. Great care must be exercised when laying and finishing the surface, so that no joints are shown, or else they will never dry out. When wanted to represent ashlar masonry, the surface is set out with lines to the size of the required stones, and then the lines are indented to form the joints with a jointer or the ring end of a key. The grain of the stone can be better imitated by patting the surface with the hand float as a finish. The staining of stucco to represent the colour of stone is done by diluting sulphuric acid (oil of vitriol) with water, and mixing with it the liquid ochres and other colours to the required tints. The setting stuff may also be mixed with the ochres before using. A small portion of the coloured stuff should be dried to ascertain the tints before laying the whole surface.

BASTARD STUCCO is somewhat better in quality than ordinary setting. The final coat is composed of $2\frac{1}{2}$ parts of washed sharp sand and 2 parts of chalk lime putty. It is laid in two coats with a skinning float, scoured up once, and then trowelled off and brushed.

TROWELLED STUCCO is generally used for work that has to be subsequently painted. The stuff for the finishing coat is composed of from $2\frac{1}{2}$ to 3 parts of washed sharp sand to 2 parts of chalk lime putty. The sand is not so fine as that used for ordinary setting, being washed through a sieve having about 12 mesh to the inch. The stuff is laid on, and then traversed with a floating rule in all directions, up and down, across and diagonally. The surface is then scoured up without water, and after a rest to admit of shrinkage, the surface is scoured up three times with water; the trowel to immediately follow the third scouring up. This trowelling is continued until the work becomes so hard that no impression can be made on the surface; it is then brushed off with a soft damp brush (not wet), first horizontally, then diagonally, and finally perpendicularly, leaving a brilliant face. When dry, the gloss goes off, and leaves a fine surface for paint.

COLOURED STUCCO.—The Italians execute lime stuccos in colours, mixing in the lime various oxides—*i.e.*, blacks are obtained by using forge ashes containing particles of iron; pearl greys are made by mixing ashes with the marble; greens are obtained by using green enamel, with a large proportion of marble powder, worked up with lime-water; browns by mixing ashes with the lime and marble in proportions varying with the tints desired; reds by using litharge, or the red oxide of lead; blues by mixing 2 parts of marble powder and 1 of lime, and $\frac{1}{2}$ of oxide or carbonate of copper. Stucco may also be coloured with the same materials as described for coloured setting, also for sgraffitto and concrete.

METHOD OF WORKING KEEL'S, PARIAN, AND MARTIN'S CEMENTS.—When describing the technique or practical manipulation of Parian and the other white cements which have been invented in the nineteenth century, it is only natural that one should feel animated by a peculiar pleasure, because in these cements, British industry, aided by modern science, has, as far as is known, equalled, if not excelled, anything of the kind produced by the ancients, tested by any experiment, whether for strength, solidity, or durability. With these a great saving in time can be effected, as work can be begun and finished in one operation, without waiting for the different coats to dry, as in ordinary lime plastering. For sanitary purposes they are unequalled. This, combined with their chemical properties, which enables them to be painted, papered, or distempered as soon as finished, renders them the most valuable of all plastering materials in this go-ahead age. They are free-working, sanitary, durable, and practically fireproof. They are the very best materials for plastering walls, dados, or in similar exposed positions. For skirtings they are invaluable, as they offer an effectual resistance to fire, vermin, and dust. When properly manipulated, they can be worked to a porcelain-like surface. They are nearly perfection, and constitute perfect plasters for most interior work. Their only drawback is that they will not resist

the effects of moisture. It is therefore imperative that damp walls should be floated with Portland cement, where a white cement finish is desirable. By the aid of the hard and sanitary white cements plastering has become a tangible reality, instead of a comparative make-shift, what it has hitherto been. The object aimed at in the invention of white cements for internal use is to produce a material of which plaster is the base, which shall set sufficiently slow to be easily manipulated, become dense, hard, non-porous, and may be painted as soon as finished. Before the introduction of these cements, all making good, as it is technically called (*i.e.*, patching holes in old plaster work), used to be done with neat plaster, plaster and sand, or lime gauged with plaster. Keen's was first introduced, then Parian, and lastly Martin's. Parian being most in demand, claims priority in description. Parian and other white cements are uniformly reliable in quality, but through the rapacity of some contractors the cements are often adulterated with plaster to lower the cost, and hasten their setting. This adulteration causes the cement to swell, and in many instances to peel or fall off. Even if it does adhere, it never attains its due hardness, and thus is no better than ordinary plaster. Unfortunately adulteration brings discredit on the cement and the trade. The only remedy is proper supervision by a plasterer who possesses a thorough knowledge of plastic materials and the methods of using them. If plasterers were awarded certificates of competency, adulteration would be prevented, and good work ensured. Honest employers would find this beneficial, for scampers can only thrive where there is a lack of knowledge of the technique peculiar to plastering, and which only plasterers of experience really possess.

In using Parian cement on lath-work, exceptional care must be observed that all the lath nails be galvanised, or painted over, or coated with shellac, to prevent rust. For this same reason all nails used for plumbing and levelling purposes must be extracted after the screeds are set. For first-coating and floating ceilings with this material, the proportions for best work are 1 part of cement to 2 of clean sharp sand, adding about the same quantity of hair as for lime plaster. Walls are generally floated with Portland cement in the proportion of 1 part of cement to 3 of sand, and finished with neat Parian. This system is adopted as a matter of economy, as Portland cement is cheaper than Parian; and where time is no particular object, makes equally as good work. For walls intended to be painted or polished immediately, it is necessary to mix the materials in the same proportion as for ceilings, with the difference that more sand may be used—say 2 parts of cement to 5 of sand. The reason for this is, that when floated with Portland, and finished with Parian, an efflorescence invariably appears on the finished surface, and until it has time to dry out, it is inimical to successful painting or polishing. Gauging is an important point; it must be carefully and quickly done to ensure success and obtain the full strength of the cement. For first-coating or floating ceilings, empty a sackful, or half a sack, according to requirements, in a clean banker; then add the sand in the proportions already given, and thoroughly mix the cement and sand while yet dry; then form a ring, and pour in the water, taking care not to pour in too much, as it must be gauged, and used as stiff as practicable. There will be no difficulty in thus using it, as it will take some hours to set, according to the season of the year (quicker in summer than in winter). When the water is in, add the hair (which must previously be well beaten and soaked), and gauge the whole mass together. Then begin the first-coating, scratch it in the usual manner, and so on, until the whole ceiling is first-coated. It should stand for twenty hours before starting to float. Hair is generally omitted for common work, or where the laths are close.

Parian cement ceilings should be dead level, and have a uniform and straight surface; therefore the screeds should be levelled, made narrow, and the sides cut square, and when firm the whole ceiling should be ruled in with a floating rule, sufficiently long to reach from screed to screed.

The floating stuff is gauged moderately stiff, and laid diagonally across the line of laths, so as not to spring the lath-work, or disturb the key of the first-coating. After the ceiling has been laid, the floating rule is applied, a man holding each end (and one at the centre if extra long). It is then drawn gently and steadily along, filling up hollow places, until the whole surface is straight and true. When the surface is firm, it is brushed with a coarse broom to form a key for the finishing coat. If there is a Parian cement cornice to be run, the usual mode for plaster and putty is adopted for the running rules. The screeds should be made sufficiently smooth to run on, without forming an extra thickness or traversing screed. The cornice is roughed out with the same kind of material as used for the floating, employing a muffled running mould for running the rough stuff. It may not be practicable to rough out all the cornice at once, as this stuff does not set quick, therefore it may be necessary to leave it for a time until the stuff stiffens. No definite directions can be laid down in this matter, as the suction is greater in some seasons and rooms than in others. A little extra hair, also extra stiff gauging, is of service to make the stuff cling together, thus allowing the work to be roughed out sooner. The running moulds must be made of strong zinc or copper—no iron to be used on any account. Where the work is in cornices, skirtings, architraves, &c., the mould should be muffled with a zinc or copper plate. If there is only a small quantity to be run, a plaster muffle may suffice. After the cornice is roughed out, it is finished with neat Parian, and then the mitres formed in the usual way.

In preparing to finish a large space (ceilings or walls) it is absolutely necessary that no more should be laid than can be finished the same day, therefore as many men should be put on the job as will accomplish that object, as no sign of a joint should be shown on the surface. In the case of large or high walls, the scaffold should be so arranged that the men can work the whole wall from the cornice down to the skirting in one operation. If a wooden skirting has to be subsequently fixed, one end of the rule bears on the fixing grounds; but if a Parian skirting is specified, it is generally run before the walls are finished, and allowed to get thoroughly hard, so as to bear the end of the rule used for the finishing coat. The lower end of the rule is cut to fit the upper member of the skirting. Another way is to nail a board on to the end of the rule, so that it bears well on the plain plinth and clears the members of the skirting. The cornice screed must be keyed with a drag before the finishing coat is laid. For large cornices it is often desirable to traverse the running screeds. In this case they must be cut down to the floating, leaving only the margin formed by the running mould. This margin forms a bearing for the top end of the rule. In some instances a special margin or bearing is cut at the outer members of running moulds for cornices and skirtings, and when run they form a bearing for the floating rules.

When ready for the finishing coat, empty as much as required of neat Parian cement into a clean banker, and gauge it smooth and stiff; then soften it down to the desired consistency, always bearing in mind not to make it too soft, as sloppy stuff for any purpose is ever to be avoided. The gauging should be so arranged that when one batch is in use another one is ready, which prevents delay in laying the whole space, thereby ensuring similarity of texture and results. The thickness of the finishing coat should not exceed $\frac{1}{2}$ inch. When there are about a dozen yards laid, two men must follow on and rule the surface fair from screed to screed on ceilings, and top to bottom on walls. The greatest possible care must be observed that the whole surface is ruled in fair and uniform, otherwise the surface will be imperfect.

White cements, owing to the suction of the walls or ceilings, have a tendency to shrink more or less, according to the stiffness of the gauge and the suction, therefore they must be ruled in twice. When the coat already laid is firm, then some more cement, gauged softer than the first,

should be laid thinly all over, and ruled as carefully as before. Having done this, the whole surface is nearly ready for scouring. It is allowed to stand for an hour or two, or until quite firm. If scouring is attempted before, it will work into hollows, and a bad job will be the result. If the finger cannot make an impression upon it easily, it is sufficiently firm, and then all hands begin to scour the work, using very little water, and working the hand float with a circular motion. The hand float must not be worked long on one spot, but kept moving over all the surface within reach, and working back again until the whole surface has an even grain or texture. The whole work must be scoured twice to bring it up to a fine solid surface. When there is about half of the wall scoured, two or more plasterers can continue the scouring, and the remainder of the men go back and start the trowelling. This must be done with good long strokes, using very little water, and taking care not to dent the surface with the trowel. After the men have finished the scouring, they come back and start at the beginning with the second "trowelling off" or final trowelling. This is done both vertically and horizontally, and when the work begins to harden, the trowel is laid on the near edge and worked with a cutting motion downwards. This is repeated all over the work until every particle of glut or "fat" is cleared off the surface. If the work has to be polished, this cutting action with the trowel must be followed with a 9-inch joint rule and a damp brush, but the work must be hard before this last can be attempted. Work carried out on the above plan will reflect credit on the material and the workers. The same methods apply equally to Keen's and Martin's. Martin's is preferred by some plasterers for running cornices because it sets quicker than Keen's. For plain surfaces, such as walls and ceilings, it sets too quick, and has to be "killed" (that is, working the stuff again and again with water until the initial set is stopped or "dead" before it can be conveniently used. Although it finally sets fairly hard, it never attains the same degree of hardness as Keen's or Parian.

Several other white cements and plasters have been introduced during the last two decades. They are enumerated and described in Chapter III.

WHITE CEMENT EFFLORESCENCE.—For work that has to be painted, care must be exercised in the selection and manipulation of the materials used for the plaster work, so as to avoid as far as possible subsequent efflorescence. In the manufacture of Keen's, Parian, and Martin's cements, Keen's original process is doubtless the best. It requires, however, great care in carrying out, the chemicals used and temperature employed requiring to be suited to the peculiarities of the gypsum. The desired result is extreme hardness, combined with non-efflorescence. Keen's cement is practically non-efflorescent, as if applied on a dry wall containing no soluble salt, in itself there would be no efflorescent that would spoil paint. Perhaps one should not say that Keen's cement, or at least all brands of it, are absolutely non-efflorescent, as there is generally a powdery coating comes on the surface, just enough to whiten a coloured handkerchief, something like the coat of puff powder used on some female faces. On no account should Keen's cement be used on walls as a preventive of damp, as it is useless for this purpose. If used on a damp wall, or in places exposed to atmospheric influences, it will effloresce more or less, as its base is gypsum, which always remains soluble. In damp situations the walls should be rendered or floated in Portland cement before the finishing coat of Keen's cement is laid. The same remarks apply to Parian and Martin's cements. The Keen's cement manufactured by Howe of Carlisle is practically non-efflorescent.

CORNICE BRACKETS.—Brackets or cores are used to decrease the amount of materials and weight, and also to form a foundation and support for cornice or other mouldings. For large exterior work they are generally formed with stone, and for small work bricks, tiles, or slates are used, which are built into the walls as the work proceeds, and roughly fashioned to an approxi-

mation to the profile of the intended cornice or other moulding. For interior work the brackets are sometimes constructed with metal lathing, also with spikes and tar bands, termed "spike and rope brackets," but the oldest and most general way for cornice mouldings are "lath brackets." The "brackets" on which the laths are subsequently nailed are cut out of boards from $\frac{3}{4}$ inch to $1\frac{1}{2}$ inches thick, according to the size and form of the cornice. The section of the brackets should be about 1 inch less than the profile of the proposed cornice to allow for a thickness of lath and plaster. The thickness of the plaster should not exceed 1 inch, or be less than $\frac{1}{2}$ inch. If too thick it is a waste of materials, and the undue weight is apt to pull or spring the laths from the brackets, and if too thin the stuff is apt to crack. The profile of the bracket need not follow closely that of the cornice, but a general or approximate outline of the most salient members followed. Any thin projecting members may be subsequently strengthened by means of projecting nails and tar strings similar to a spike and rope bracket; also by using extra hair and plaster in the roughing-out stuff. Brackets for enriched cornices require special notice. Unless a due allowance is made for sinkings for the thickness of the cast enrichments and a correct form of bed, there will be unnecessary trouble in cutting and hacking the lath work and brackets when the running of the cornice is commenced. There is a marked difference between the section of a running mould for an enriched cornice and that of a plain cornice, even if the profile of both are the same. To avoid mistakes of this nature the plasterer should supply the carpenter with a section of the brackets taken after the bed of the enrichments are set out on the tracing of the proposed cornice.

Scotch brackets is a term applied to a method sometimes used for coring out angles, to save materials where there are no brackets, and for small mouldings. This is effected by placing the mould in position and then fitting a piece of lath in a vertical position, and allowing a space of about $\frac{3}{4}$ inch from the face of the lath to the nearest part or most prominent member of the mould. A mark is then made on the ceiling and wall at the top and bottom of the lath. Similar marks are made at the other end of the wall and ceiling, and then a line is struck on the marks, from end to end of the ceiling and wall, by means of a chalk line. The stuff which forms the parts of the screeds inside the lines is cut away, dusted, wetted, and then a narrow strip of gauged coarse stuff is laid along the lines where the ceiling and wall screeds are cut, and the laths, which have been previously cut to the length of the first or trial one, are fixed vertically into the gauged stuff, keeping them apart as in ordinary lathing. They are further secured by laying strips of gauged stuff on the outward surfaces at the top and bottom ends. After the stuff is set, the cornice is run in the usual way.

CORNICES.—Cornices, either plain or enriched, are formed with a running mould cut to the profile of the intended cornice. The formation of cornices consists of constructing the mould, making the running screeds, fixing the running rules, running the cornice and mitring the angles, with the addition of fixing the cast ornament for enriched cornices. Cornices were formerly run in short lengths and in sections. Two, three, and even four moulds were employed for cornices that are now done with one. For large cornices, where the mould is difficult or sluggish to run, or apt to jump, the bearings should be greased or brushed with soap or dusted with powdered black lead or French chalk. Running moulds are run in Scotland with the left hand, from left to right, and the mould plates are also fixed to the left hand side, having the bevelled part of the stock to the right or running side. In England the plates are fixed on the running or right side, and the mould is run with the right hand from right to left. The Scotch way of running from left to right with the left hand allows more freedom, especially in small mouldings, for the right or trowel hand to assist in feeding the cornice with the stuff that gathers on the mould. It also gives more

freedom to his partner who is laying on the stuff, as with the hawk in his left hand and his trowel in his right he is able to work in a natural position, namely, from left to right, as in laying coarse or setting stuff on walls, whereas, when the mould is run with the right hand, and from right to left, the worker has not so much power or freedom in assisting to feed the mould with his left hand. His partner, who is laying the gauged stuff, is working backhanded, and if using a laying trowel, can only work from its heel instead of from the point as is usual; and if using the large gauging trowel for laying on, every trowelful used must be put on with a backhanded turn. It may be a matter of opinion as to which method is better, and depends a good deal upon which way the man has been taught, but the manner of running the mould and laying on of stuff from left to right, the same as in writing, is the most natural. Running screeds are used as bearings for running moulds. They are composed of gauged stuff, and made straight with floating rules. Screeds for cornices are formed with raw or with gauged coarse stuff. They are next traversed, termed in the North of England "sweatened," and in Scotland "justed." The line of the screen is got by placing the running mould in its true position at one end of the wall, and making a mark on the floating screeds at the outside of the nib and the bottom of the slipper. The same operation is repeated at the other end of the wall, and a continuous line from one mark to the other made on the ceiling wall by means of a chalk line. A narrow strip of gauged putty and plaster is now laid on the lines by one man, while his partner follows on with a traversing rule, working the rule with a slanting motion, and moving backwards and forwards until the screed is just and true. Where the walls are very long, running screeds are done by two men working a long straight-edge or floating rule. The screed is afterwards further fined by drawing a cross-grained hand float three or four times over it in a longitudinal direction. Where the coarse stuff screeds are not gauged, the running screeds are made in a similar manner, but the putty is mixed with an equal proportion of setting stuff before gauging. The addition of sand gives more resisting power to the wear of the nib and slipper of the running mould. The running screeds are made on the long sides of the room, and when set they give a bearing for the end screed in its true position at one end of the wall.

Fixing the running rules is the next operation. This is done by placing the running mould in its true position at one end of the wall, taking care that the mould is "square," that is, that the perpendicular parts of members are plumb with the wall. This may be tested with a plumb-bob hanging over the side of the mould, and by seeing that the line of the plumb-bob hangs properly over a marked line which has been previously made by squaring off from a square member or by extending a parallel line from an upright member of the mould. The method of plumbing running moulds is illustrated in Chapter VII. When the mould is plumb and square, a mark is made on the ceiling screed at the outside part of the nib, and another made on the wall screed at the bottom of the slipper. The same operation is repeated at the other end of the wall, and the line extended from mark to mark by using a chalk line. The line in this case should be blackened by means of charcoal or burnt stick, as it shows better than a white line on the light-coloured screeds. As the chalk line may sway when striking the wall line, this line should not be trusted for fixing the running rules to. This may be proved by placing the mould every 3 or 4 feet apart in the length of the wall, taking care to keep the outer edge of the nib at the ceiling line; then marking with a gauging trowel at the bottom of the slipper. Nails are now driven into each of these marks and left projecting as a guide for fixing the running rules. The running rules should not be less than $2\frac{1}{2}$ inches wide or more than $3\frac{1}{2}$ inches wide and $\frac{1}{2}$ inch thick, being made out of good red-wood or pine planed on both sides and edges. The rules are now fixed into the wall screed either by nailing them to the studs or into the joints of the walls. They are also fixed by wetting one

face of the rule and laying dabs of gauged putty and plaster about 2 feet 6 inches apart. The rules are now pressed on the wall while the stuff is soft, taking care not to force the guide nails out of position. The rules are further secured by laying patches of gauged stuff underneath the rule partly on the wall and rule where the dabs are. When the rules are fixed by nailing, it is apt to crack the first-coat of floating, and the joints of the wall are not always easily found. The coarse stuff for the first-coat of cornice brackets should be extra haired and carefully scratched to give a strong foundation for the following coats of gauged stuff, which in many instances is extra thick at bold or projecting parts of the mouldings.

For large moulding and wire lathing it is best to leave the brackets uncoated when first-coating the general work until the cornice running is commenced, and then to rough out the whole cornice from the lath work with gauged coarse stuff. This gives uniform suction and strength. If the brackets are lathed with wood, they should be first-coated with gauged coarse stuff and scratched before the screeds are formed, so as to allow time for the lath work to settle before the mouldings are roughed out. Weak laths frequently twist by moisture from the first-coating, and gradually settle or resume their original form during the drying of the first-coating. Leaving the lathed brackets uncoated also forms a vent for the moisture from the wall and ceiling first-coating, thus allowing it to dry sooner. The coarse stuff for roughing out the cornice should be gauged uniformly in strength and consistency, as unequal gauging tends to cause unequal swelling in the material, consequently the mould is more difficult to run true. The coarse stuff should be laid regular in thickness, taking care to gradually build up and form all thick parts and projecting members with the trowel to prevent the stuff from dropping and the mould from dragging it off, as generally happens if the stuff is laid in thick and irregular coats. When roughing out large mouldings with coarse stuff, the members of the mitres should also be filled in and ruled fair before the running with gauged putty is commenced, because when mitring, it will be more easily and quickly done, materials will be saved, and when finished, the whole will be more uniform in colour.

When all the mouldings are roughed out, the plaster muffle or muffle plate, as the case may be, is taken off, and the running with fine gauged putty commenced. The gauge board and all tools should now be cleaned to free them from grit. A ring of putty is formed on the gauge board, leaving the bottom of the board clear; water is put in the ring, and the plaster quickly and evenly sprinkled over the water, taking care not to sprinkle it on the putty ring. The plaster and water are mixed together by stirring with the point of a trowel. The putty is then quickly mixed with the gauged plaster by using the trowel and turning it over with the hawk. It is put on with a large gauging trowel, or if the members are large, with the laying trowel, following the form of the mouldings. The mould is then run along by one man, who also feeds the moulding with any stuff that may gather on the side of the running mould. This operation is continued until all the members of the moulding are filled out. A thin gauge of fine putty, having less plaster than the previous gauges, is lightly drawn over with a trowel, or brushed over the flat members, and thrown with a brush for small or dry members. The mould is then quickly and steadily run along the cornice from beginning to end and finished. If the moulding is extra large in girth, or a long length of moulding has to be run, extra men are required to lay the stuff, while two may be necessary to run the mould.

When running small mouldings, say of 10 or 12 inches in girth, one man can run and feed the mould while his partner is laying on. When all the mouldings are run round, the running rules are taken down, the screeds cleaned and scraped, and any holes or defects caused by nails or

patches used for the rules made good by filling up with gauged stuff. If soap, black lead, or any other materials already mentioned are used to aid and ease the running of the mould, they should be scraped off with a drag as soon as the cornice is run off, otherwise they will prevent the finishing coats for wall and ceiling from adhering to those parts.

TO SET OUT AND CONSTRUCT A CORINTHIAN ENTABLATURE.—To enable the plasterer to set out a full-size or working drawing from the architect's design, also to comprehend the cornice and the architrave, which are sometimes used alone or as separate mouldings, their proportions with that of the entire entablature are given. The entablature and the details of the enrichments of the coffers and modillions are shown on Plate XXIX. The whole height of the entablature is divided into ten parts, giving three to the architrave, three to the frieze, and four to the cornice, as shown by the first upright scale at Fig. 1. This figure shows the combined section and elevation of the entablature. The height of the architrave is subdivided into five parts to form its members, as shown by the second upright scale. The projection is taken from the lower fascia, and is equal to one-fourth part of its height. As the cornice of the Corinthian order is frequently used alone as a separate moulding, an enlarged view, with figured details, is given see illustration No. 16, page 114. It is necessary that the details of the cornice should be mastered before proceeding with the entablature.

With regard to the enrichments of the entablature, as shown in Fig. 1, the whole must be set out and so disposed and arranged that the centre of each will be in a line with each other, or, in other words, that they are regularly disposed perpendicularly above each other, as shown from A to B (Fig. 1), where it will be seen that the centres of the modillion, dentil, egg, and other bed-mould enrichments are all in one perpendicular line. Enrichments set out in this way are said, in plasterers' parlance, to "principle." Nothing is more careless, confused, and unseemly than to distribute them without any order or principle, as they are in many buildings. The centre of an egg answers in some places of the cornice to the edge of a dentil, in some to the centre, and in others to the space between, all the rest of the enrichments being distributed in the same slovenly, artless manner. The larger parts must regulate the smaller. All the enrichments in entablatures are governed by the modillions or mutules, and distribution of these must depend on the interval of the columns, and be so disposed that one of them may come directly over the centre of the column, as shown in the present example at C (Fig. 2), the axis of each column.

The enrichments must partake of the character of the order they enrich. When the frieze is enriched, the enrichment may be characteristic of the order, or it may serve to indicate the use of the building, the rank, qualities, profession, and achievements of the owner. Having set out the profile and the enrichments, making the running mould and running the mouldings now claims attention. For large work the cornice and architrave are run separately, the cornice being run from a slipper screed made on the frieze and a nib screed, and the architrave from a slipper screed made on the wall and a nib screed made on the frieze. Sections of the cornice and architrave running moulds are shown at Fig. 4.

It may be here remarked that the nib and slipper bearings of the cornice and architrave running moulds are made for work on ceilings and walls; but if the entablature projects or is independent, and supported by columns, the nib of the cornice mould must be cut so as to bear and run on a nib running rule fixed on the weathering of the cornice, and the slipper of the architrave running mould cut so as to bear and run on a running rule fixed on the soffit of the architrave. The frieze, if plain, is set by hand; and if enriched, a bed for the enrichment must be made by running a small part of the bed at the top and bottom of the frieze when running the cornice and

architrave mouldings. In this case the screed on the frieze must be set back to allow for the plate or ground of the ornament, and the nibs and slippers of the running moulds extended at these parts. In setting out the mould plates an allowance must be made for the bed of the various enrichments, as previously described.

The profiles of the three largest enrichments are indicated by the dotted lines. The angles of the beds of these enrichments are splayed, as shown, to save fine plaster used for the cast work. This also strengthens the top member of the architrave while it is being run. It will be seen that an in-dentil is used in this cornice, as shown by the dotted line at *t* on the elevation. This is the space between the face or main dentils. The in-dentil is run with the mouldings, and the dentils are cast and planted. The in-dentil and the dentil may also be cast together in short lengths, and then planted. In this case the running mould must be cut to form a bed for the combined dentils, as indicated by the dotted line on the outside of the section of the running mould. The dotted line on the section of the running mould shows the section of the main dentil. In some examples the external angles of the bed of the dentils are filled in with an ornament fashioned like a cone or pineapple, instead of using an angle dentil. An enlarged view of this class of ornament fixed in position is shown at Fig. 11. The bed of the small enrichments is made square as shown.

When setting out the mould plate, the profile of the soffit of the corona must be taken through the centre of the sunk panel, as shown by the shaded part at Fig. 3, thus forming the raised part of the mould, as shown at Fig. 4.

The most intricate part in the construction of a Corinthian cornice consists in the formation of the coffers, as shown at Fig. 2. This is a plan of the cornice at an external angle. *F* is a coffer, and *M* is a modillion or "block," as it is commonly called. The coffer consists of a sunk panel, with an enrichment on the four sides, and a rose or patera in the centre as shown. A section of the coffer is shown at Fig. 3. The coffers are formed by fixing a "style," as from *s* to *s* (including the side enrichments), on the sunk panel, so as to connect the two run plain sides of the soffit and form two sides of the coffer. The lines in the front and back of *s* and *s* indicate the joints of the style before they are stopped. It will be understood that the style is fixed before the block is fixed. A plan of the complete style is shown at Fig. 5. When making the model of the style, the side enrichments must be set out mitred and fixed on the plain part of the style, and a perforation made in the centre to act as a key for the fixing stuff used when fixing the block. A mark must also be made in the centre of the front of the style to act as a guide when fixing the styles. The model of the style is moulded in wax, taking care to splay the back and front edges and the centre perforation, also the mitres of the enrichments, to allow the mould to draw in one piece. These parts are trimmed square after the styles are cast. Having fixed two styles, the front and back parts of the coffer enrichments, as shown at Figs. 6 and 7, are fixed; then the patera (Fig. 8) is fixed; and then the joints of the styles are stopped, which completes the coffer. This done, the block (Fig. 9) is fixed, and then the small enrichment (Fig. 10) is fixed, thus completing a part of the soffit of the corona. The other parts are of course made and fixed in a similar way, but the positions of the coffers and blocks must be set out on the whole length of the cornice before the fixing is commenced.

Setting out coffers and blocks is a simple matter, yet it requires care to ensure accuracy. First fix a coffer and a block in each mitre, as shown at the external mitre (Fig. 2); then from the centres of these blocks set out the whole length of the cornice. This is best done by measuring the full length of the cornice from the mitre blocks, and dividing the total by the combined width of one modillion and a coffer, and if there is no remainder, the combined width is marked on the

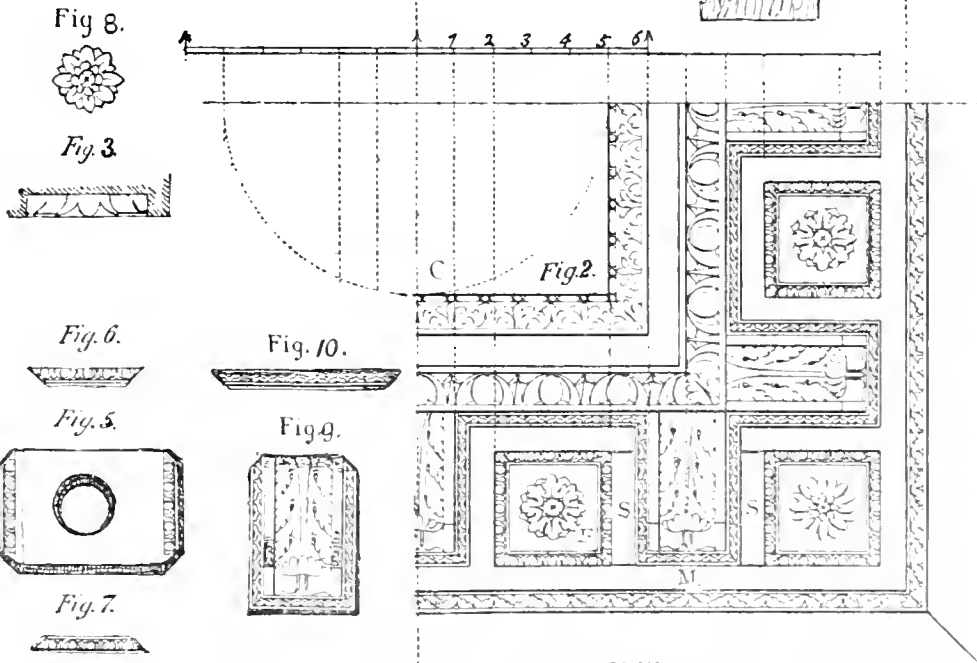
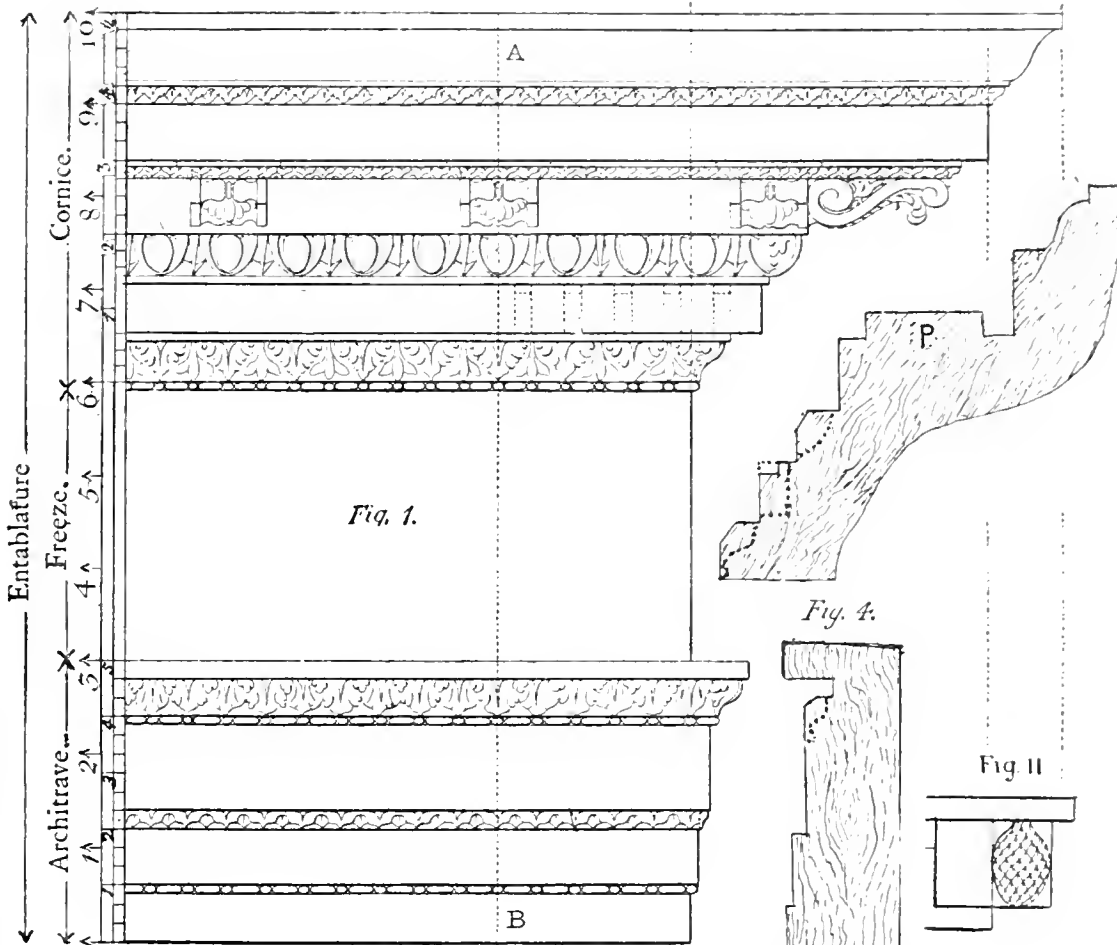

ELEVATION OF CORINTHIAN ENTABLATURE AND PLAN OF CORNICE AT EXTERNAL ANGLE.

soffit; but if there are a few inches over, they are divided among the given number of blocks. The marks are proved by going over them with a compass or a wood gauge. When the exact positions of the centres of each coffer with the block are ascertained, the marks are extended across the corona and down the plain member on which the back end of the block rests by the aid of a square. These extended marks or lines give the centres for fixing the styles of the coffers and the blocks. Fixing the coffers and blocks is the next part of the process. This being done, as already described, taking care to use the centre mark on the coffer as a guide for fixing it fair with the centre lines on the soffit, and using a wood square to prove the square of the style, also using the edge of the square to prove the level of the coffer with the run sides of the soffit, then clean off any excess stuff that may exude at the keyhole and edges of the style. After this the back and front side enrichments are fixed, as already mentioned. Before fixing the pateræ a keyed or undercut hole must be cut in the sunk panels to give a key for the stuff that is used for fixing the pateræ. A corresponding keyed hole must also be formed on the back of the pateræ. This is best done by making the desired size of sinking in the model of the patera before it is moulded. These sinkings must be undercut after the pateræ are cast.

The model of the patera is generally moulded with a front and back waxed mould. For large pateræ, or those having a deep projection, a piece of twisted galvanised or copper wire, sufficiently long to enter the keyed holes in the patera and the soffit, should be inserted in the fixing stuff when fixing the pateræ. This method should always be adopted where the bedding surface of the patera is small, so as to enable it to resist the weight of a brush while being painted or gilded. If the pateræ are extra deep, and project below the line of the soffit, they should be fixed first, otherwise they are liable to get disturbed when fixing the blocks and other enrichments.

The modillions should be fixed with stiff gauged stuff for the keyed holes in the styles, and the corresponding holes in the blocks (which are made while being cast), and using softer gauged stuff for the bedding surface of the block. After the fixing stuff is laid, place the block in position, and work it gently but quickly from right to left, so as to force the excess stuff out, and obtain a true and solid bed, taking care that the centre of the block is linable with the centre mark on the soffit, and using a square to prove the squareness of the block, and then clean off the excess stuff. The small enrichments (Figs. 6, 7, and 10) are fixed with soft gauged stuff, so that they can be easily and quickly fixed. Small cast work of this kind should always be fixed with soft gauged stuff, as there is very little weight to carry until the stuff is set. The suction alone between the two bodies is often sufficient to support the cast until the stuff is set. These small enrichments are moulded with a face or front wax mould.

Modillions or blocks were formerly cast in three parts, namely, the body, the main part of the leaf, and the tip or curled end of the leaf; the body being cast in a wax piece mould (sometimes a plaster piece mould), and the leaf and its tip in a front and back wax mould, but now the complete block is generally cast in one piece in a gelatine mould. The body of the block may be cast in a gelatine mould, but where the back section of the leaf is clear or away from the block near the scroll end, as shown in the accompanying illustration, and seen in fine old buildings, the leaf should be cast and fixed separately. An enlarged view of the plan and side elevation of a modillion is shown in illustration No. 15. The bed moulds and the other small enrichments in the entablature are generally cast in wax moulds.

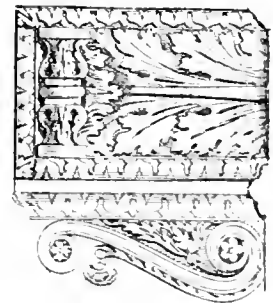

No. 15.—MODILLION.

When fixing the enrichments in an entablature, take special care that they all "principle" with each other as already mentioned, thus forming a pleasing and artistic finish, which is characteristic of well-designed mouldings.

TO SET OUT A CORINTHIAN CORNICE. —The members which are enriched in the cornice, shown in the preceding plate, are drawn as plain members on this cornice so as to show the profile and method of setting out more clear.

The combined elevation and profile of the cornice shown at Fig. 1, in the accompanying illustration, No. 16, is an enlarged view of the cornice of the Corinthian entablature. The first

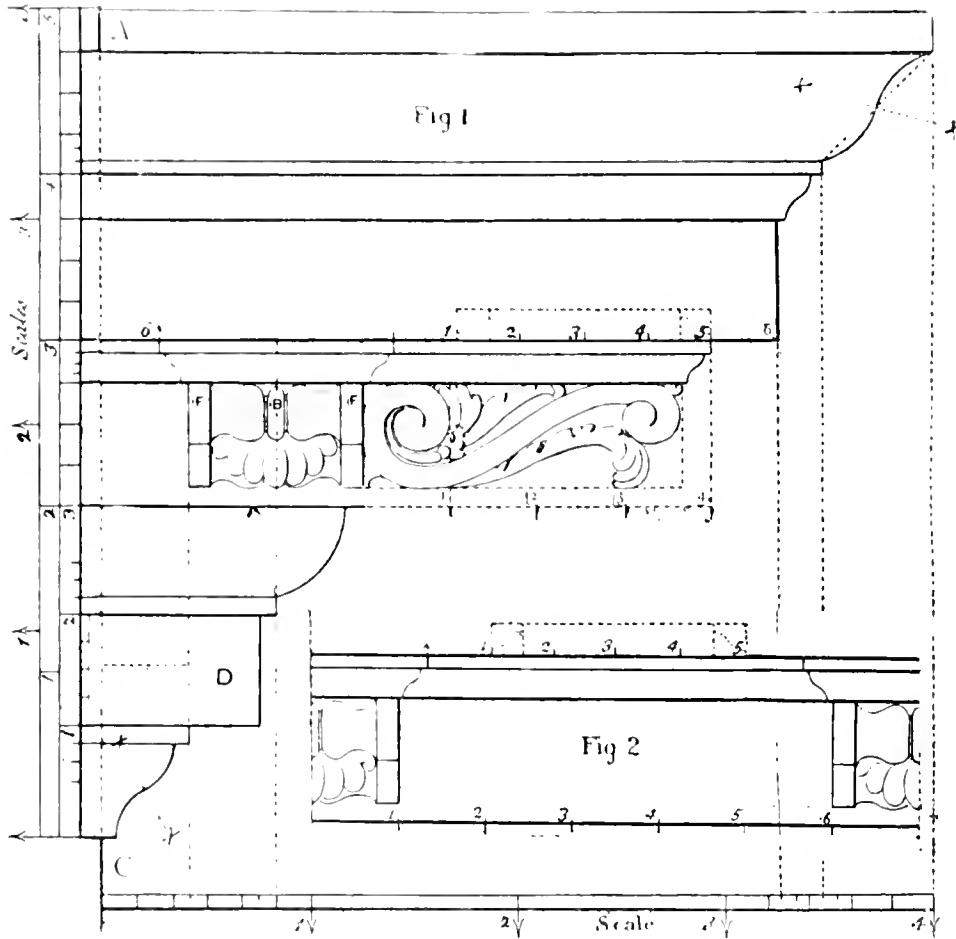

NO. 16. CORINTHIAN CORNICE.

upright scale contains four parts of the ten into which the whole entablature is divided, as on the preceding plate. The second scale is divided into five parts, the third of which goes to the modillion, the fourth to the corona, the fifth to the cymatium; the first and second together are divided into three parts, the first for the reversed cyma at the bottom, the second for the dentils, and the third for the ovolo. The smaller members are in proportion to the greater, as shown by the smaller divisions on the scale. The modillions are $\frac{1}{2}$ of the diameter of the column, and their distances two sixths and a half. Half a diameter is divided on the corona at Fig. 2 into six parts, of which the width of the modillion is two, and the length of it is four. The cap projects $\frac{1}{2}$ of those

parts, and the distance between the modillions is five. By this rule the exact distance from centre to centre of the modillions is $\frac{1}{2}$ of the diameter. The dotted line AC answers to the diminished part of the column, from whence the cornice is projected; the projection being equal to its height, is divided into four parts, as shown by the scale at the bottom of the cornice. One-fourth of this scale is divided into six parts, as shown at c, five of which give the width of the modillion. The distance between them is in proportion to it as figured at Fig. 2. The fillets, FF, of the modillion are $\frac{1}{4}$ of its width, and so is the bead, B. The position and size of the sunk panel are indicated by the dotted lines in the corona at Figs. 1 and 2, the size being obtained as shown by the figures in the dotted spaces. The width of the dentils, D, is obtained by dividing the semi-diameter of the column marked on the corona at Fig. 2 into fourteen parts, two of which give the width of the dentil, and one the space between them. This space of course is also the width of the in-dentil, the height of which is one-fourth of the height of the main dentil, as indicated by the small division on the inner side of the second upright scale.

The centres and radius for describing the profiles of the cymatium or cyma-recta, the ovolo, and the inverted cyma or ogee members are indicated by small crosses and dotted lines.

MITRING.—Mitring is looked upon by the generality of plasterers as a test of speed and ability. As they generally work in pairs on other portions of the work, their individual ability is not easily seen, but when mitring a man carries the operation through alone. Mitring being done by hand, is a near approach to modelling, and is an operation of which a dexterous and good plasterer is naturally proud. The quality and time required for mitres greatly depend upon the degree of hardness of the run cornice, also upon the suction. A mitre can be more freely worked and more expeditiously done on a hard cornice surface, and where there is a suction. The extra absorbing powers of brick walls as compared to lath partitions cause the gauged stuff to get firm sooner, and enables the mouldings to be more readily blocked out before the stuff is set. A common error when mitring is gauging the stuff stronger than that which has been used for the running of the cornice, causing extra swelling and difficulty of ruling the members over, and cutting the run part of the cornice with the joint rule, especially if the stuff sets before the plasterer has had time to rule all the members over, and then being stronger, and consequently setting quicker, he has not so much time for forming the members. Ordinary-sized mitres can be done with one gauge by using less plaster than in the gauge for running the cornice, and stiffening the greater portion with dry plaster, and using this for roughing out the mitre; then using the soft portion left for brushing over the members and filling up all holes, and afterwards working the joint rule over the metal to take the superfluous stuff off. Should the mitre not be fine enough, the gauged stuff can be further softened on the hawk by adding water, and working it with the gauging trowel, brushing the soft or creamy stuff all over the mitre again, then working the joint rule again. Small members, and those at the top and bottom of the cornice, where there is most absorption, should be worked by the joint rule first, leaving the large members, drips or coves, or where there is a large body of stuff, to be ruled over last. The joint rule should always be worked horizontally, especially when dealing with beads and cavettos. Drips and large members should be worked with the joint rule with an upright motion, because if worked down, the stuff may be pulled down. Mitres should not be worked, fined, or tooled with small tools, as they can and should be brought to a good and straight surface by the proper use of the joint rule. Small tools should only be used for laying the stuff where required, and cleaning out the intersections of the mitres, quirks, and for stopping. A square-ended small tool may be used for smoothing flat, straight surfaces. Returned mitres and short breaks are "run down," then cut to the required lengths and planted. They may also be mitred by hand.

MITRE-MOULD. —Various attempts have been made to construct a running mould that would form the mitres simultaneously with the cornice running. Most plasterers will have heard of, and some may have tried to make and work a mitre-mould to save hand labour. Those who have tried it will have found the results far from satisfactory. The subjoined illustration No. 17 shows the method of setting out and constructing a mould intended for forming the moulding and mitres in one operation. The mould is made by fixing the metal plate at an angle of 45° on the slipper, or in other words fixing the iron plate at one angle of a square slipper, which allows the mould to run nearly up to the angle, one face of the slipper being used for one side of the wall, and the other face at right angles being used for the other side of the wall. Fig. 1 shows the method of setting out the profile of mould. A is a given section of a moulding, and B is the section

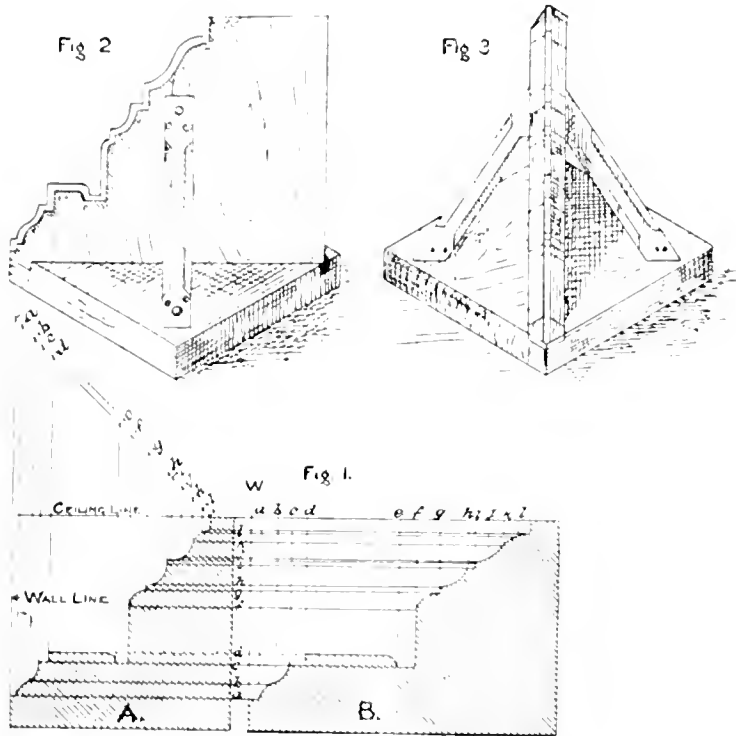

NO. 17.—MITRE-MOULD.

of the moulding at the mitre. To obtain this, first draw the moulding A full size, and then extend the ceiling line and draw another wall line. Then from the projection of the top member draw an angle line at 45°. Carry up the projections of the various members to the angle or mitre line, and then draw horizontal lines from the various members; also centre lines of large members as from *a* to *l* (the vertical letters). Take off the lines *a* to *l* (diagonal letters) on the angle line, and set them on the ruling line from *a* to *l* horizontal letters, and then laying them down to the horizontal lines, the intersections give the profile for the mitre-mould.

Fig. 2 shows a side elevation of the mitre mould, and Fig. 3 shows a front elevation. It will be seen that the mitre-mould is

an expensive and unsatisfactory fad. The time expended in setting out the elongated members, making an extra mould, and cleaning out the intersection by hand (as the mould does not leave a finished mitre, also making good the parts broken by drawing out the mould from interlocked or undercut members in the moulding, is not repaid. An average plasterer would put in all the mitres of an ordinary-sized room while the mould was being made. The mould will only run into every second angle, and must be taken off and reversed to fit the next. It may seem a waste of time and space to describe and then show the utter uselessness of a mitre-mould, but having met many plasterers who stated that they had used or had seen a mitre-mould that worked wonders, I am constrained to give a description, not only to save future futile controversy, but to show that in this book the much-debated trade subject has not been omitted. In concluding this subject, it may be stated that not any one of the mitre-mould plasterers would or could

practically explain the *modus operandi* of this mysterious mould. A description and illustration, by Mr T. Drake, of a mitre-mould, on the same principle as here given, appeared in *The Builder*, 1848. The mould is taken off at the centre of the length of the cornice, and then the part broken by the mould made good.

FIXING ENRICHMENTS.—Enrichments should be fixed straight, square, plumb, and firm. Cornice enrichments, such as bed moulds, friezes, &c., for which a bed or sinking to receive them is formed by the running mould, do not require such strong gauged stuff as soffits, modillions, or other hanging casts. For light enrichments the gauged putty and plaster should never be stronger than that used for the cornice, and clean strong size water should be used. This gives more time for fixing a number of casts, and improves the cementing force. The bed for the cast work should be scratched, dusted, and wetted before the cast work is applied. A small portion of fine plaster (the same as used for casting the enrichments) should be gauged with clean size water, to be used for the joints. The gauged fixing stuff should be spread evenly over the back of the cast and over the scratched bed of the moulding. No more should be laid on than will fully fill up the scratches. Then place a small piece of the white or joint gauge on the joint, and press the cast into position by gently but quickly sliding the cast twice or thrice backwards and forwards to expel the air and incorporate the two bodies. It is a mistake to dab a lump of gauged stuff at random on the back of the cast and press it on the bed, as the stuff does not properly enter the scratched part of the bed, and the contained air prevents proper cohesion and solidity. When too thick a coat of stuff is laid on the cast, straight and even fixing is more difficult. The excess stuff oozes out at the sides, and unless time and care be taken in cleaning it off, the moulding, or cast, or both, get damaged. A small portion may also ooze out in the first method, but it will be so thin that it can be brushed off while soft. When fixing modillion blocks or trusses, a dovetailed hole should be cut in the vertical and horizontal parts of the bed, and similar holes in the blocks (which are made when being cast) are filled in with gauged stuff and applied in position. If the cast should be very heavy, or of Portland cement, it is further secured by inserting a slate or iron dowel while the stuff is soft, allowing a portion of the dowel to project to enter into the body of the cast. Heavy casts should be temporarily supported by wood props until the fixing stuff is set. When fixing heavy casts, the plain surface of the plaster work should be cut as far as the lath, to obtain a better and stronger key. The putty in the fixing stuff should be mixed with long strong hair or tow, as described for rib mouldings or ceilings. Hair or tow may also be used advantageously in fixing Portland or other cement work. Cast work, when extremely heavy, should be further secured by means of long screws or bolts, placed so as to pass through the cast work and into the timber, the casts being bedded with gauged haired stuff, and temporarily propped up. The screws or bolts should be fixed before the stuff is set, to avoid the probable disturbance of the gauged bedding. Before fixing any cast work, they should be placed in position to prove their correct fitting. Centre, side, and end lines should be made on the surface of the bed to give a guide for fixing. It may be necessary to fix nails at intervals in the lines to give a further guide.

MITRING ENRICHMENTS.—Before fixing continuous or space cast work, the length and width of the panel or room should be set out to prove that the mitres are equal-sided, balanced, and have flowing lines. Nothing looks so slovenly or unworkmanlike as a mitre in an ornament cut haphazard, with the leading stem disjointed, or springing out of a flower or tendril. If the design is vertical, say a bed mould or frieze with an alternate leaf and husk, what can be more offensive to artistic taste than a part of the leaf on one side and a part of the husk on the other side of the mitre! There is no excuse for this want of taste and wanton treatment. A little time expended in

setting out the work will obviate these defects. Where there are no shrinking and stretching casts the mitres can be eased by stretching or shrinking the cast work at the joints. Stretching or shrinking are evils, and it depends on the design of the enrichments which of the two is the less, but in most instances shrinking is the greater evil. Shrinking does not require so much labour to make the joints good. Stretching does not show quite so much, especially if the joint is well modelled and of the same colour. It also gives greater scope and freedom. It has already been mentioned that in good shops the breaks or other short lengths are set out in the shop, and that there are stretching and shrinking casts and mitres modelled and made to facilitate the formation of good mitres. This latter method is certainly the cheapest and most satisfactory in the end. The setting out is best done by cutting a lath as a gauge to the length of the cast, and marking the length of each cast temporarily on the bed of the cast work from mitre to mitre. When the mitre has been determined on, and the casts set out to come in, the marks are made more distinct to give



NO. 18.—FRIEZE, PALACE CHAMBERS, LONDON. W. MILLAR, 1875.

a guide for fixing each separate cast as required. It is better to measure thrice than alter twice. Space ornaments should also be set out accurately, but there is no difficulty in the mitres, as the intervening space between each cast can be increased or diminished as required.

When fixing modillion blocks, dentils, or paterae, the mitres should be fixed first, and then the spaces and positions set out. Special care must be taken when mitring enrichments with distinctive vertical parts, such as figures, or pendants of flowers or fruit in friezes, that the cast work is not unequally or irregularly stretched, so as to enable them to come to an equally balanced mitre at the angles. Where there are no stretchers, the cast work should be cut between the main vertical parts, so that the joint on each side will be equal, or, in other words, that the vertical parts will be equidistant from the main or other parts when fixed. The same remarks apply to shrinking. The annexed illustration, No. 18, is a portion of a frieze consisting of a swag of flowers and pendant of flowers designed and modelled by the author for the Coffee Room, Palace Chambers, Westminster, London, and is now used to illustrate the above. From A to B is the length of the cast. It will be

seen that if the joint was kept open for stretching purposes, or cut for shrinking purposes, that it would form an unsightly and unequally balanced joint, whereas if cut true between the vertical part (or flower pendant) and the main portion (the swag of flowers), as shown by the joint at A, the joint can be stretched or shrunk equally on both sides. Another way is to mould and cast the swag separate, also the flower pendant, as shown at D. This was the method adopted for the above job, where there were a large number of mitres and bays to contend with; and in addition to this, a stretcher of the swag part was specially made, so that all the mitres were alike, a flower pendant being in each external and internal mitre.

The mitres of running enrichments, such as soffits, &c., are made up with bands or ribbons, which are cast or worked *in situ* by hand. The latter way is the quickest and most artistic. Another plan is to fix pateræ or drops at the internal and external mitres. The scroll work of the enrichment is then formed to spring from the patera, and finish at the patera at the next mitre. Sometimes the inner member at each side of the soffit is worked across at right angles at each mitre, thus forming a small square sinking or panel, which is then filled in with a patera or drop.

Bed moulds, such as an egg and dart, have internal and external mitre leaf modelled and cast. This is a neat and quick way of forming mitres. A good cornice, with well-modelled and effective ornament, may be disfigured and

spoiled by careless mitring, yet it is as easy (and in many cases more so) to make good and satisfactory work. It is therefore best to set out correctly, and make sure of a correct finish before beginning to fix. Illustration No. 19 shows the method of mitring various forms of fret enrichments. Examples of cast mitres are given in Chapter X.

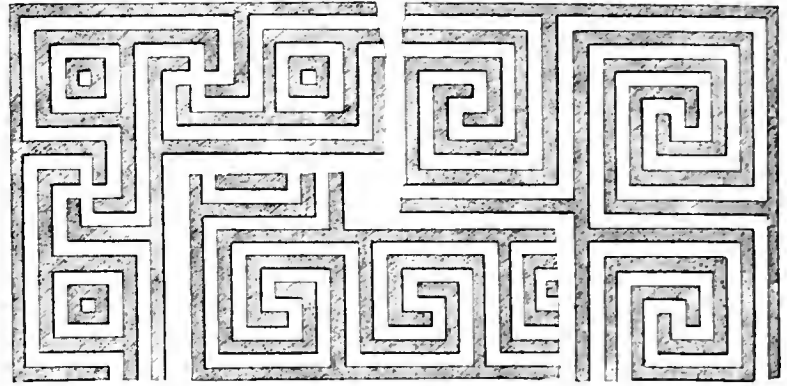

NO. 19.—FRET ORNAMENTS, SHOWING THEIR MITRES.

PUGGING. — Pugging in Scotland called deafening, is a body of plastic materials laid on boards fixed between the joists of a floor, or lath and plaster partitions. It is intended to prevent sound and smells from passing from one room to another. Pugging is generally performed by laying a thick coat of coarse stuff on a foundation of rough boards on fillets, which are nailed on the sides of the joists. Chopped hay, straw, or ferns, mixed with lime, is sometimes used for the plastic coat. Coarse plaster, with and without reeds, is also used in some districts. Sawdust is sometimes substituted for reeds. In Scotland, pugging is done by forming a foundation with thick rough lath wood. On this a coat, about $\frac{1}{2}$ inch thick, of coarse stuff is laid, and when dry, a layer, about 2 inches thick, of dry ashes or lime riddlings is deposited on it. The upper surface is then sprinkled with water, and finished with a coat of coarse stuff. This makes sound proof work, but in the event of subsequent damage or alterations, the dry ashes run out, causing further dust and damage. In some instances the dry ashes are gauged with lime. When laid, the upper surface is beaten and smoothed with a shovel. This makes sound proof and durable work, impervious to vermin. Partitions are deafened by lathing between the studding, and then laying on a coat of coarse stuff. When dry, the partition is lathed and plastered in the usual way.

Pugging slabs of fibrous plaster are now largely employed. They have the advantage of being light and dry, and are rapidly fixed.

SOUND CEILINGS.—No lath and plaster ceilings can be made sound and free from cracks unless the joists are well seasoned, firmly fixed, and sufficiently strong to carry the overhead weight, as well as sustain the weight of the lath and plaster, and resist jarring. Ceiling joists should never be more than 12 inches apart from centre to centre. Where double lath is used, the joists may be 14 inches from centre to centre. Good laths, with break joints every 3 feet, and well nailed, are also imperative. If the above dimensions are exceeded, the laths are liable to give or twist, on account of the weakness of the laths, or the weight of the plaster, or both combined. If the joists exceed 2 inches in width, they should be counter-lathed or strapped, to ensure a key for the plaster. Where it is impracticable or inconvenient to fix the ceiling joists so close, they should be brandered. This strengthens and stiffens the joists, also gives a free key for the plaster, and forms a sound level ceiling.

Brandered or strapped ceilings are done by nailing wood straps or fillets across the under side of the joists. The fillets are from $1\frac{1}{2}$ to 2 inches square, and are fixed from 12 to 14 inches from centre to centre. The sizes and distance apart varies according to the thickness of the lath and the class of plaster work. Brandered ceilings are largely used in Scotland, and make good sound ceilings.

CRACKED PLASTER WORK.—Cracks in plaster work are due to various causes. They may act individually or in combination. Cracks are often caused by settlement in the building. These cracks may be easily discerned by their breadth, depth, and length. They also arise from the shrinkage of bad or unseasoned timber used in the construction or framing of the building, which may cause displacement in the joists or the laths. Cracks are sometimes caused by the laths being too weak, or by too much plaster being laid on weak laths, or too little plaster laid on strong laths. Other causes are the too sudden drying of the work; strong winds or heat; the laying one coat of mortar on another coat, or on walls that have a strong suction which absorbs the moisture or "life" of the coat being laid, when it becomes short, or crumbly, scaly, and apt to peel or fall off. In this last case it does not set, but only dries and shrinks, which gives rise to cracks, and eventually falls or crumbles away. The use of bad materials, insufficient use of lime and hair, or scamping of labour is often followed by cracks. Insufficient labour and unskilled workmanship in the application of the materials is a great source of trouble, but it will be understood that the best quality of labour will not make bad materials good and strong; and, on the other hand, the best materials will not compensate for bad labour. It is only by judicious selection of materials, and their skilful manipulation, that a high and enduring class of work can be obtained.

REPAIRING OLD PLASTER.—Repairing is also termed "patching," "jobbing," and "making good." When repairing or making additions to old plaster work, care should be observed in cutting the joints, so that the key of the existing work is not injured or broken. The joints one way should be cut on the studding or joists, and in a line with the laths the other way. A joint at the edge of a lath is stronger than at the centre. If the lath work is weak, the joints should be cut diagonally. Never use a hammer to cut joints on lath work, for the repeated impacts will weaken and crack the old work. If the old plaster is hard, cut the joint with a saw, or with a hammer and chisel, and finish with a strong knife. Avoid acute angles in patches. Square, round, or oval patches not only look better, but are much stronger than zig-zag ones. Having cut the joints neat and square on edge, and then repaired the old lath work, brush the joints and the laths with

a dry broom, and then wet the joints, but only damp the lath work, as excessive water tends to warp the laths. The joints are sometimes painted to prevent damp from extending to the old work, or causing injury to any surface decoration. Gauged coarse stuff is generally used for roughing out, and gauged putty for finishing ordinary work. The coarse stuff is generally gauged with coarse plaster. For small patches, the whole thickness is generally brought out in one coat; but for large patches it is best to lay a first coat, and then scratch it in the usual way. If time permits, this should stand for one day, or even two, to allow the lath work to settle. The stronger and stiffer the gauge, the less power the laths will have to warp. The floating coat is gauged moderately stiff with coarse plaster, or with fine plaster and coarse in equal proportions.

When laid, the surface is ruled in with a straight-edge, keeping it within the line of the old work to allow for plaster swelling, and a thickness of $\frac{1}{16}$ inch for the finishing coat. It is often necessary to drag the surface down to allow the finishing coat to be ruled fair and flush with the old work. The surface should be left fair but rough. Gauged work should never be scoured, as it only kills the plaster, and therefore weakens the body of the material. The putty for the final coat should be gauged with fine plaster and a little size water. After being laid, the surface is ruled flush with the old work, and when firm it should be smartly trowelled off, and finally finished with a semi-wet brush. The joints should be trowelled flush and smooth, and the old part brushed to free it from any gauged stuff. All rubbish should be damped as it falls, and removed as soon as possible to prevent further dust and dirt.

Parian or other white cements are used for best work, or where time is a consideration. All white cements having plaster for their basis are manufactured to be non-efflorescent, non-porous, durable, free from liability to unequal shrinkage (which causes cracks), and free in working. They form admirable materials for repairs or additions. When making good old or broken lime plaster work with any of these cements, the joints and lath nails must be painted with red lead, quick-drying paint, or with shellac. Galvanised nails ought to be used for the lath work where these cements are to be used. Small holes and cracks are usually stopped with fine plaster gauged with putty, or better still, putty water. Parian cement is also used for a similar purpose. The holes and cracks should be brushed with Parian solution before the stiff Parian is applied. This solution is simply fine Parian gauged to a thin creamy consistency with water. New or damp lime-plastered walls can be painted or papered much sooner, and with greater safety, if brushed with a thin Parian solution. It is also useful for stopping the suction on dry floating and fibrous slabs before laying the final coat. Several of the new patent plaster and white cements are well adapted for repairs, or where time is limited.

GAUGED WORK.—All gauged work should be regulated in strength according to the purpose required. A brick or stone wall would not require so much plaster as a lath partition. Work not subject to friction or wear does not require so much plaster. If the work is required for immediate use, as with running screeds, or blocking out large mouldings, or fixing large castings, much plaster must be used. The amount of plaster required for scaffold work varies from $\frac{1}{4}$ to equal proportions for gauging coarse stuff or setting stuff, and from $\frac{1}{8}$ to equal proportions for coarse stuff for heavy cornices, and $\frac{1}{16}$ to equal proportions for putty and fixing ornament. The amount of plaster also depends upon the quality of the plaster, some of which are much stronger than others. Coarse plaster that is of a dark and sandy nature is generally weak, sets quickly, and becomes soft and useless. Fine plaster should be used for gauging putty when running cornices, also for fixing enrichments. All gauged work should be gauged with uniformity, each separate gauge having the same amount of water and plaster as required for the bulk of stuff being gauged. Unequal gauging

causes hard and soft places in the work, and when more plaster is used in one gauge than another there is an extra expansion caused by the swelling of the plaster, which makes the work more difficult to do when floating, setting, running mouldings, or mitring.

A quart and a pint measure should always be kept on the scaffold for measuring the water used for the various gauges. The quantity of water will regulate the quantity of plaster for each gauge. A proper plaster box should also be on the scaffold, made to hold a sack of plaster, and having a lid made in two halves hinged from the centre. This prevents the plaster from getting dirty by falling stuff, and from getting damp by absorption from the atmosphere. Where there is a large quantity or continuous gauging, the box should be placed on a stand—this is called a stand-box—to prevent unnecessary exertion and loss of time by stooping for each handful. A “stand-box” is illustrated in Chapter XXI.

When gauging coarse stuff for large surfaces which require several gauges to complete the work in hand, size water should be used in proper proportions with the neat water used for gauging, so as to allow sufficient time to properly manipulate the material. This also allows the various gauges to be laid on or against the previous ones while they are in a soft state, thus forming stronger joints and better cohesion between the various gauges. In the event of gauged stuff setting before the work is laid and ruled off, it is difficult to make the surface strong and fair. The use of size water in gauged setting stuff and putty enables the work to be freely trowelled and finished. Gauged stuff should not be hand floated, as excessive working destroys the setting powers of the plaster.

JOIST LINES ON CEILINGS.—Common flat ceilings show in time the precise position of the joists above, and in many instances the position and form of the lath work can be easily discerned. Many theories have been advanced as to the cause of these unsightly lines or marks, which are so distressing to the mind and eye. In my opinion they are due in a great measure to insufficient material and inferior work. The plaster which is between or separate from the joists is more pervious to the atmosphere than that which is in more direct contact. The air in passing through leaves behind it particles of dirt assigned in larger measure to the unattached than to the attached portions. Dust that finds ingress between the joints of flooring boards lies on the unattached portions, consequently the joists show themselves as lighter lines on a more or less dirty background. The same causes apply to the lines on the lath work. Another cause is that the plaster work is too thin. In many instances the floating is brought up from the lath in one coat. This is a most pernicious habit, as it is not only the cause of lath lines, but the ceiling invariably cracks, and develops spontaneously quite original patterns indicative of rivers, which too often lead like Niagara to a catastrophe in the form of falling plaster. Joist and lath lines on thin ceilings may be partly obviated by laying strong brown paper over the upper side of the lath and plaster and then pasting the edges to the sides of the joists, so as to form a cover to the plaster work. The better and most sanitary way is to lay the work in three coats, allow the first coat to dry, consolidate the floating coat by well scouring with a hand float, and render the setting coat hard, non-absorbent, and impervious to air by thorough scouring, trowelling, and brushing.

CHAPTER V.

DECORATIVE CEILINGS.

HISTORICAL—PANELLED, FIGURED, AND RIBBED CEILINGS—RIB BRACKETS AND LATHING—FLOATING PANELLED CEILINGS—SETTING OUT PANELLED CEILINGS—PANEL MOULDINGS—COFFERED CEILINGS—PLANKED PANELLED CEILINGS—SETTING PANELLED CEILINGS—HARD FINISH—FINE FINISH—CLIMENT FINISH—PORTLAND CEMENT CEILINGS—FIBROUS PLASTER PANELLED CEILINGS—WORKING PLANS OF PANELLED CEILINGS IN KING CHARLES' ROOM, WINTON, CAREATH HOUSE, AND BLESACK—PANELLED CEILINGS AT EDINBURGH, THRONE ROOM, HOLYROOD PALACE, LIVERPOOL, BRADFORD, DUBLIN, FORFAR, AND GLASGOW—GOTHIC CEILINGS—MODERN GOTHIC PLASTERERS—GOTHIC CEILING AT TODDINGTON—GROINED CEILINGS—GROINED CEILING AT TRINITY COLLEGE JACK TEMPLATE FOR GOTHIC RIJS—SPIKE AND ROPE BRACKET—MIRING RIB INTERSECTIONS—OLD GOTHIC MATERIALS—CLASSIC PANELS.

HISTORICAL.—The use of plaster as a covering and smooth surface finish for walls and ceilings is conducive to health and comfort, and gratifying to the eye. Ceilings afford great scope for decoration, yet it seems a strange defect in our modern method of decoration, that in many mansions the walls of the principal rooms are highly decorated with expensive papers, to be afterwards partly or wholly covered with pictures, looking-glasses, and bric-à-brac, and the floor is covered with carpets, to say nothing of furniture; but the ceiling spreads its broad blank waste of white above us, expressionless and inartistic to a great degree. The ceiling being the crowning glory of a room, and the part most seen, should be decorated with form and colour.

It is true the ceilings are whitewashed, but the same monstrous monotony prevails all over the house, from the basement to the attics. The cellar, scullery, and passage ceilings are treated on a scale of equality with the ceilings of the principal rooms in the house. Whitewash is an excellent material in its proper place, but not in the best rooms, as it is washed off and redone at short intervals, and besides the annual cost there is the additional injury to one's feelings and furniture. Whitewash should be entirely dispensed with, as being disastrous to decorative plaster work. It gradually blunts and blurs the arrises, lines, and shadows of mouldings. It clogs and obliterates the modelling and outlines of ornament, and after repeated washing off and renewing, finally destroys and renders the plaster work a distorted, unmeaning, and unrecognisable mass. If whitewash must be used on moulding, from a want of knowledge or from immediate but false economy, let the plaster have two coats of thin oil paint. The whitewash, when dirty, can then be washed off with less injury to the surface of the plaster. Some whitewashes, also wall papers, are objectionable from a sanitary point of view, because they are absorbent, and the size, glue, or paste used in their working are more or less deleterious. Painting plaster work at an extra first cost is cheaper in the end. It hardens the surface of the plaster, prevents absorption, and can be periodically washed with less mess and more speed than whitewash. It is also not so readily affected or spoiled by the injurious impurities of gas. It seems inconsistent to concentrate time and money on expensive wall papers, and surmount it with an abrupt top finish in the form of an elaborate plaster cornice, and leave a broad bare expanse of ceiling surface.

A little time and thought may be wisely and advantageously devoted to the decorative part of

ceiling plaster work. The matter of expense is small if the after and lasting artistic effect is taken into consideration. Nothing catches the eye so quick'y as a graceful and well-designed ceiling, with the rib moulding well defined and forming geometrical panels. The panels or moulding may be relieved with appropriate foliage, and the introduction of the owner's monogram, date of building, or other desired devices. Economy of decoration is nowhere to be so much deprecated as here, as a large barren space of white ceiling has a most heavy and oppressive effect; the contrary being the case where a ceiling is artistically decorated with neat and well-balanced mouldings, panels, and artistic ornament, and afterwards painted and relieved with gold judiciously applied.

As there seems to be a growing tendency towards the reintroduction and use of decorative plaster ceilings by modern architects of culture, it is desirable that plasterers should have a thorough practical knowledge of the art of this beautiful branch of their craft. The illustrations herein will serve to demonstrate what plasterers were capable of in the past in design and execution. I believe that there are good practical plasterers and artistic modellers at the present day able to carry out the same class of work if opportunities were offered, and that if there were a demand the supply would soon follow. The subject of ceiling decoration is so interesting and extensive, that to do it justice it would take a special book, full of illustrations. It would be worthy the attention of some of our city and art bodies to afford opportunities to plastic art students to collect sketches and information of the many fine examples to be found in the three kingdoms.

One of the most important and beautiful parts of plastic art is the decoration of ceilings. In the reign of Edward VI., the English plasterer had rapidly learnt the art and was largely occupied; and almost every house of importance erected during the reigns of Elizabeth and James I. was adorned either internally or externally, and often both, with his work. Not educated to the highest branch of the plastic art, he generally avoided figure work, and took refuge in geometric pattern. Nor was this without other reason, for the lowness of our rooms required a less ambitious treatment than did the lofty salons of France and Italy. The fan tracery of the Late Gothic of Henry VII.'s time afforded them an excellent starting-point; and its radiating ribs and pendentives, such as you see at King's College, Cambridge, Oxford Cathedral, Henry VIII.'s Chapel, and in much other Perpendicular vaulting, offered an excellent suggestion. It readily lent itself to the subdivision of the ceiling into squares of lozenges, and circles abounded, many of the arrangements being equally beautiful and ingenious; but rarely were large figure subjects introduced amongst them, small emblems, armorial bearings, and personal devices being used to fill up the voids of the geometric pattern. Gradually the size of the subdivisions increased, until it became the practice to divide the room into four quarters, and no matter what their size, unless they were long galleries and corridors, the patterns occupied a quarter of that space reversed. This made half the room, and that half doubled completed the design. The enlarged cartoon thus obtained led to the abandonment of merely geometric pattern, and soon lines of wondrous device took possession of the ceiling—involved, contorted with quaint unexpected quips and cranks, a true parallel, in fact, to the moderate magnitude, as in the "Watching Chamber" at Hampton Court; Red Lodge Park, Bristol; Stockton, Wilts, Crewe, and all over the country; and not even when the rooms were ceiled between the main beams, in order to gain height, did this trabeation prevent the adoption of this quasi-Gothic treatment.

This pendentive system outlived the radial tracery form from which it sprung, though the radial root form often exists on pendants, even when there are no correlative ribs on the ceiling. The geometric arrangement of the ribs soon became infinite—interlacing quatrefoils, squares, quaintly involved diction of the time.

In the earlier ceilings these ribs were plainly moulded after the manner of groin ribs. As the power of execution grew, they had flat surfaces often ornamented by impressed ornament, run on by a revolving stamp like a bookbinder's tool, with here and there a bossage of higher relief from a wooden matrix, fashioned like a butter stamp. These ribs have moulded edge and hand-wrought bosses at their junction, producing an exceedingly rich effect. It has been suggested they are borrowed from Continental sources, but there is no evidence of plagiarism, and there are radical differences between the Renaissance of England and that of other countries sufficiently marked to enable us to distinguish them.

Again, plastered ceilings were not common in the countries whence these designs came, wooden ones being chiefly in use there. It is probable, therefore, that our master workmen had their own album of designs, and travelled about the country with them, frequently repeating them. They do not seem to have often published books of designs in this country at that date, though in 1615 Walter Geddes published "Sundry Draughtes principally serving for Glaziers and not impertinent for Plasterers," giving outline diagrams of geometric forms; but beyond one or two of the most obvious ones, nothing identical can be traced in the executed plaster work. If the character of our ceilings had resembled those of other countries, they would not have so excited the admiration of foreign visitors. The Duke of Wurtemberg, who visited England in 1598, expresses himself astonished at their richness and beauty; and Sir Henry Wotton, King James' Ambassador to Venice, where stucco work abounded, whilst recognising the good use we made of it in our ceilings, urges us to make larger use of it for figures, for "plastique art," says he, "is not under sculpture, but very sculpture itself, but with this difference, that the plasterer doth make his figures by addition and the carver by subtraction," quoting the Italian use of it for "mantling of chimneys with great figures." Of such stucco mantels there are some examples in England, but it chiefly maintained its sway on our ceilings, with frequent external pargetry between the timber framework.

In the early part of Charles I.'s reign the same principle of design continued, but towards the latter part of it the influence of Inigo Jones and Rubens was decidedly detrimental to the stucco workers. The Palladian character of the architecture, and the trabeated and coffered ceilings of the architect, led to the use of cast enrichments of mouldings, and the desire for large spaces for the painter's figures did away with the lesser division of the ceiling, and though the painter on the ceiling imitated stucco work, the stucco worker himself was banished. Then came the troublesome time of the Commonwealth, with the Spartan severity of the Puritans, and so both forms of decoration were destroyed, and at the Restoration it was found necessary to import French and Italian plasterers to execute what little was demanded. This, however, was not much, for Verrio and Laguerre held sway, and the stuccoer had only to prepare the ceilings and friezes for the painter. Indeed, had more been needed, it could hardly have been obtained, for, as the stucco-worker's art had stagnated during the troublous period, it, like all that stagnates, died. Again, most of those who had any love for art found themselves on the wrong side of politics, and either perforce or voluntarily left the kingdom. When they returned they brought foreign fashions and foreign fashioners with them. Thus, when Lord Montague rebuilt Montague House, he employed Peter Puget, a French architect, to design it, and Monnoyer, the French flower painter, came over to decorate it. Monnoyer not only painted flowers, but modelled them in stucco, and hung festoons and wreaths everywhere, and garlanded everything, endeavouring to make his stucco wreaths compete with the carved wooden ones, such as Grinling Gibbons and his followers did so well. These floral decorations held their sway for some time, often surcharged and pretentious, as in the ceiling at Astley Hall, where the amount of labour expended is by no means commensurate with the effect. It partook too much of

the technique of the pastrycook and confectioner to have a lasting hold, and was soon followed by a better and purer character brought in by the Italian stuccatori, who again flocked into England. Not only on the ceiling but on walls the stucco worker displayed his skill, and stucco once more became a favourite mode of decoration. The pupils and followers of Sir Christopher Wren adopted it; and most of the houses and public buildings erected in the first half of the last century are adorned with very excellent work, indeed so national had this custom become that in 1736 it was said plastered ceilings "are much used in England beyond all other countries; and they have these conveniences with them—they make the rooms much more lightsome, are excellent against raging fire, stop the passages of dirt, and lessen the noise overhead, and in summer time the air of the room is somewhat cooler." The long foliated character of ornament, erroneously called of the Chippendale style, followed this—a weak travesty of the French ornament of the time of Louis XV., but frequently of beautiful workmanship. To this succeeded the revived classic mode, in which the expiring efforts of the stucco worker exhausted themselves. Run mouldings and cast ornaments henceforth prevailed. Thus expired the art and craft of the modeller in stucco.

PANELLED CEILINGS.—The term "panelled ceiling" is generally applied to any ceiling whose surface is divided into spaces by beams, girders, or mouldings. Those enriched with mouldings are also known in the trade as "figured" and "ribbed" ceilings. The term "panelled" is more correctly applied to those having coffers or caissons, or where the ceilings are divided into spaces by beams or girders. The spaces between beams are usually termed "bays," and they are often further panelled with mouldings. "Figured ceiling" is a term sometimes applied to ceilings having small mouldings, or where the design is composed of geometrical figures. "Ribbed ceiling" is a term generally applied to those with rib mouldings on the intrados of arched or circular ceilings, also to flat ceilings having circular mouldings. "Decorative flat ceilings" is a term applied to those with flat surface modelled ornamentation, but without rib mouldings.

The ceilings of the Romans were generally of three kinds—the "hemispherical vault," the "barrel vault," and the outcome of the intersections of the latter, viz., the "ground vault." It may be said that mouldings of any form or number on a ceiling must divide the surface into panels of some shape or size, hence, for the sake of simplicity, the term "panelled" (unless the groined or other special kinds will hereafter be used).

Panelled ceilings may be formed on joists (wood or iron), brick, stone, or concrete work. The first part is the brackets, if heavy mouldings are used; and then the lath work, if on wood joists. If on brick or stone, the joints should be cut out, and the surface hacked, to afford a key for the plaster. Concrete surfaces are left rough, or fixing blocks inserted while the concrete is being laid. The fixing blocks are to receive lath studding or fibrous plaster as required. Iron work is fitted with wood clamps for a similar purpose. Those keyed surfaces are then first-coated, and floated with strong coarse stuff. Screeds for the mouldings are next formed, and then the ceiling set out. The mouldings are next run and mitred, and then the panels are set. In some instances the whole ceiling is set first, and then the panel mouldings planted. The different processes are as follows:—

RIB BRACKETS AND LATHING FOR PANELLED CEILINGS.—Large ceiling mouldings, such as coffers or caissons, mock beams, all require lathed brackets to form a foundation for the plaster work. Spike and rope brackets are generally used for ordinary-sized ceiling mouldings. The mouldings may girth up to 12 inches or even 20 inches, but the girth need not be considered, provided the moulding is not too deep. Any width of moulding can be amply secured by using two or more rows of spikes. Rib mouldings 6 inches and 9 inches deep have been run on those kinds

of brackets. Where the mouldings are wide and deep the floating should be cut down to the lath work. This gives a further key to the bracket. The floating should be cut out before the spikes are driven, so as to give more freedom for driving, and allow the lath work to be properly cleaned and damped. Before the lath work on the ceiling is begun, small joists or strong quartering should be fixed between the main joists where required, to receive the spikes. It is of the utmost importance that the lath work for panelled ceiling should be sound and sufficiently strong to carry the rib mouldings. For wood lathing, double lath gives the best results. Metal lathing is not only strong, but has the advantage of being practically fireproof. It is false economy to use inferior materials for this class of work. Rib and cornice brackets can also be formed with some kinds of metal lathing. A spike and rope bracket is illustrated on page 144.

FLOATING PANELLED CEILINGS.—Panelled ceilings demand sound foundations. These are formed by the first coat and the floating coats, the former being laid on well-seasoned and strong laths, securely nailed, or on corrugated metal laths, or wire netting. The first and floating coats should be composed of strong-haired and well-tempered coarse stuff. It is of the utmost importance for panelled ceiling, and indeed for all kinds of plaster work where lime is used as a base for the first coating, floating, and setting (more especially if the lime is of a rich or fat nature), that each coat should be allowed to stand as long as possible before the next one is laid. This method of laying the stuff in thin coats, with a considerable space of time between the layings, is conducive to the ultimate hardness of the whole. Each coat is long exposed to the carbonic acid of the atmosphere before being covered with the next. It is a common practice in some places to place a fire of coke in a chauffer in the centre of the room, for the purpose of drying the plaster more quickly, but the carbonic acid given off by the coke plays a very important part in the hardening, as well as does the heat in drying. For the best class of work, or where the mouldings are heavy, the coarse stuff should be gauged with $1\frac{1}{2}$ parts of strong coarse plaster. Great care must be taken in the floating, so that the surface will be perfectly level and straight. Cornice screeds (the main screeds) are first formed on all sides of the ceiling, and levelled by means of lath dots, which are proved by the aid of a parallel ceiling rule. After the main screeds are made, narrow ones are formed across the ceiling, and are ruled flush with the main screeds. The narrow screeds are laid from 4 to 6 feet apart, or as required, and then the intermediate spaces are filled in and ruled flush with the screeds. Gauged work should not be hand floated with water—water and working tends to kill the plaster—but the work may be left moderately rough, to act as a key for the running screeds and setting stuff. If the ceiling has few mouldings, running screeds (of gauged putty, for the running mould to bear on) are formed, where the mouldings are required. If the ceiling has numerous mouldings, thus necessitating a double quantity of screeds—one for the nib and one for the slipper of the running mould—it is best to form the whole ceiling smooth as well as level and straight, thus forming one vast screed. This may be done by filling up the rough places in the floating with soft-gauged coarse stuff, and then floating smooth with a traversing rule, working the rule over the stuff all ways—lengthwise, crosswise, and diagonally—and testing with a long straight-edge, and finally finishing with a hand float. The stuff should be gauged with size water, to give time for properly ruling and floating before it is set. Another plan—a good one, and often adopted for best work—is to leave the floating straight yet rough. This is best done by using the floating rule flat on its face, and with a zig-zag motion cut off the excess stuff. If there are any smooth parts on the surface left after this ruling, they should be roughened with a stiff coarse broom before the stuff is set, or, if set, with a rough drag, and then brushing off any loose particles. While the work is still green, form thin and narrow screeds to the main ones, *i.e.*, screeds for the main

cornice, and from these form a series of more narrow ones, about 10 or 12 feet apart, across the ceiling. When the screeds are set, fill in the intermediate spaces, and rule off flush. Before the spaces are filled in the narrow screed should be tested crossways with a long straight-edge, to see that all are linable. Where practicable, the whole ceiling should be laid and ruled off from the main screeds. The surface is made true and smooth with a straight-edge, working it in all directions—crosswise, lengthwise, and diagonally—using a little soft-gauged stuff to make good any defects, and finished with a hand float in a similar way. The stuff for the above process is composed of setting stuff, mixed with one-tenth part of well-beaten white hair, and then gauged with size water and one-third part of fine plaster. All ruling and scouring should be completed before the stuff used for each part of the process is set. When the mouldings are all run and mitred, the haired coat must be roughened with a sharp drag, to key the surface and also fray the hair, to give a further key. The surface is then dusted, leaving the frayed hair loose and rough, thus ensuring a perfect and permanent key and cohesion for the final coat. Panelled ceilings may also be floated direct from the lath work, and the surface finished, and also the mouldings formed with most of the white cements or hydraulic plasters described in Chapters II. and III.

SETTING OUT PANELLED CEILINGS.—A knowledge of practical geometry is a useful acquisition for setting out panelled ceilings. Without this knowledge, plasterers will be disappointed as to their speed, proficiency, and accuracy, and they will labour under great disadvantages from not understanding the principles upon which all geometrical and all other forms of panelled ceilings are founded. The rule-of-thumb plasterer may think that he can set out the ceiling from the drawing, but in most instances the drawing contains no scales, radius centres, and lengths. Yet even if those details are given, a geometrical knowledge saves time and trouble, and gives the keynote for setting out the full-sized working plan on the ceiling. Therefore it follows that while the rule-of-thumb man is wasting time, temper, and energy, the proficient plasterer proceeds at once, and sets out the ceiling correctly, expeditiously, and in a workmanlike manner.

Panelled ceilings are set out by various lines, which are formed on the ceilings, their numbers, positions, and uses varying according to the design. For perspicuity and simplicity the lines are divided into two classes, the first being the "skeleton lines," which give the plan, showing the widths, forms, and positions of the mouldings and panels; the second are the "working lines," from which the various mouldings are formed. There are three kinds of skeleton lines, viz., "centre lines," "width lines," and "radial lines." The centre lines represent the centre, or half width, of the panel, mouldings; from these all measurements for others are taken; therefore, being the main ones, they are formed first. The width lines represent the width of the bed of the mouldings, and are used to show the intersections, and as a guide when cutting out the floating for keying purposes. They also are used as a fixing guide when planting mouldings. The radial are extra lines which are required for certain designs. They are struck lengthwise, crosswise, and diagonally as desired, and are used to give the radius centres for circular mouldings, and the angles of radiating mouldings, also to prove the squareness of panels, and the intersections of moulding. There are three kinds of working lines, viz., "screed lines," "rule lines," and "template lines." The first mentioned are formed at the nib and slipper bearings of the running mould, and are used as guides for forming the running screeds. These are not required where the ceiling is floated and formed as a whole screed surface, and are only used for sunk panels and beams, or where the ceiling is left rough from the floating. The rule lines give the position, and act as guides for fixing the running rules. The space between one of the width lines and the rule line is equal to the width of the bearing part of the slipped side of the running mould. The template lines are used as guides for fixing templates and

trammels. A good guide for fixing templates is obtained by using centre marks and angle points, which are got from or made on the centre and radial lines, similar marks and points being made on the template. The corresponding marks are brought together when fixing. To avoid confusion, the various lines should be made with different colours, thus—Black (charcoal or burnt wood) for centre lines; red (ochre or chalk) for width lines; yellow (ochre) for radial lines; and brown (umber) or white (dry plaster) for the screed, rules, and template lines. White should not be used on a white surface, but it may be used for screed lines where nicety is not necessary, or on a dark surface where it can be easily discerned. All width and rule lines are taken from the centre ones. This is best done by the aid of a "mould gauge." This gauge is cut from a piece of thin running rule, and to the length of the combined widths of the moulding and the slipper part of the running mould. One end is rebated equal in length to the slipper part, and a permanent mark is made on the centre of the remaining part, which is equal in length to the width of the moulding. For instance, if the moulding is 6 inches wide, and the slipper part 2 inches wide, the gauge would be 8 inches long. When the centre mark on the gauge is laid fair with the centre line on the ceiling, a mark is made on the ceiling at one end of the gauge and another at the inner square end of the sunk part, which gives the widths, and another mark is made at the outer square end of the rebated part, which gives the rule line. The square ends at the sunk parts allow a mark to be made with greater accuracy and rapidity than if made at a mark on the front side of the gauge. Marks are made by the aid of a knife and the mould gauge at both ends of the intended moulding, and the lines extended with a chalk line in the usual manner. Most measurements and all repeated lengths and widths are best done with a "size gauge." It is quicker and more accurate than a 2-foot rule. A "size gauge" is simply a running rule, or a lath cut to the desired length.

Having mastered the names and uses of the lines and gauges, the setting out will be greatly simplified. The main cornice is run first, and from the outer members the measurements for the panel mouldings are taken. With a few exceptions all rib or panel mouldings spring from or intersect with the main cornice, the upper members of which are the same in size and profile as the panel mouldings. It is an important point to take the measurements from the centre of those members, and not from the outside member, because the centres of those members are equal to the centres of the panel mouldings. The neglect of this initial point has been the source of many mistakes. The same remarks apply to ceilings panelled with beams or sunk panels. The positions of the centre lines are marked on the ceiling at the outward member of the main cornice, and when the marks have been made all round the room, they are extended longwise and crosswise by means of a chalk line. If the designs contain diagonal or circular mouldings, the radial lines are formed in the same way. The mould gauge is now applied at both ends of the various centre lines, keeping the centre mark fair on the centre line, making marks for the width lines, and extending the lines as before. No rule or other working lines should be made until the skeleton lines have been proved correct. After this the working lines are made and the running rules fixed, ready for running the panel mouldings.

PANEL MOULDINGS.—Panel mouldings for ceilings are either "run" or "planted." Run mouldings are those run *in situ*, and planted are those that are "run down" (*i.e.*, on a bench or running board), then cut to the desired lengths and mitres, and then planted or fixed on the ceiling where required. If there are no wood brackets, the floating coat should be cut down to the lath work, so as to obtain the best possible key for the mouldings. For deep moulding, a spike and rope bracket is used, as already described. The coarse stuff for roughing them out should be extra haired and strong gauged. A muffle plate should be used on the running mould. A muffle plate is an extra

plate cut about $\frac{1}{4}$ inch larger than the profile of mould plate, and is screwed on the mould plate to act as a muffle to form a space for the finer material used for the finished surface. After the mouldings are roughed out, the muffle plate is taken off, and the fine surface finished with the original or mould plate. This is cheaper and quicker than making plaster muffles, especially when there are a large quantity of mouldings to be run. A muffle plate is also best when running panel mouldings in white cements. When many men are at work on a panelled ceiling, or even when there are numerous panels, it is best to have one or more sets of running moulds—one set cut to the muffling line, and another set cut to the finished line. When this method is adopted, due care must be exercised that all the moulds are "horsed" alike in size and form, that they may fit the running rules and screeds in unison. It is often necessary to plant short or circular parts where there is little or no space for the running mould to work. Mouldings that are run *in situ* are generally stronger than if planted.

Coffered ceilings, or those having deep panel mouldings, are usually bracketed and lathed. Screeds are formed on the soffits or centre of the brackets, and on this parallel running rules are fixed and a half of the moulding run from each side. In most instances an enrichment is used in the centre of the moulding. In this case the screed should form the bed for the enrichment. A level line and uniform depth of panel surfaces is obtained by levelling from the main screeds by the aid of a parallel ceiling rule and wood gauges. For ordinary-sized moulding (on lathed brackets) the panel surfaces should be levelled, and the moulding formed in the usual way. It is sometimes advisable to cut the brackets at the intersections to admit of the mould being run in continuous or long lengths.

PLANTED PANELLED CEILINGS.—Panelled ceilings having small mouldings and numerous short or circular pieces, or small or intricate panels, are best done by a process technically termed "planting" or "planted." The mouldings for this process may either be "run down" or cast. The term "run down" is derived from the fact that the mouldings are run down on a bench or a running board instead of being run up on the ceiling or *in situ*. Mouldings run *in situ* are simply termed "run." When the mouldings are "run down," they are cut to the desired lengths and mitres, ready for planting in position. For planted work, the mouldings may also be cast in neat plaster, or in any white cement, as required. Reeds were formerly used to strengthen both run and cast work. Fibrous plaster casts are now also used for planted work. They are lighter and generally stronger than solid mouldings, either cast or run down. The planting or fixing of ceiling or panel mouldings requires great care, to ensure accuracy and permanency. All mouldings, whether run down or cast, should be well undercut in the centre and cross-scratched on the bedding parts or outer edges, a corresponding deep undercut being made on the ceiling, also cross-scratched on the width or bed of the moulding. The fixing stuff should be composed of haired putty, gauged with an equal part of fine plaster, and sufficient size water to retard the setting as required. A portion of the gauge is stiffened with dry plaster, and used for filling in the deep undercuts in the cast and the ceiling. The softer stuff is used for the cross-scratched parts on the cast and the ceiling. The stiffened portion gives more strength, and allows the two thick parts to unite better and quicker than if filled with soft stuff. The latter is spread over the scratched parts of the cast and the ceiling, being pressed well into the crevices of the scratching, so as to expel all air and afford a solid joint. The cast is then applied to the ceiling, and worked quickly but gently backwards and forwards into position. The working to and fro unites the two surfaces, and expels any globules of air or superfluous stuff. The intersections must be tried with a straight-edge or joint rule, to see if the piece being fixed intersects with the adjoining piece. Heavy pieces may be further secured by screwing

to the joists. It will be understood that nails or thin rules are fixed on the line at one side of the moulding, to act as a guide while the piece is being fixed. These kinds of panelled ceilings are generally set before the mouldings are set out and planted. In this case no rule lines are required, and no hair should be used in the soft portion of the fixing stuff, as the hair, unless a close joint is made and the stuff cleaned off, is apt to disfigure the ceiling. The stuff that exudes should be cleaned off before it is firm with a square-ended wooden tool, and the joint stopped with stuff similar in colour to the cast. White hair is generally used in the putty for fixing fine work. Black hair is generally coarser than white. The latter, being nearly of the same colour as the work, is not so noticeable in the event of its being retained on the surface.

SETTING PANELLED CEILINGS.—The setting of finishing coat of panelled ceilings requires great care in the selection and manipulation of the materials. Various materials and methods of using are employed, each having some individual merit for special purposes. The following materials and methods are those generally used, viz., "putty finish," "hard finish," "fine finish," and "cement finish"—the latter embracing different kinds of cements.

LIME PUTTY FINISH.—This is the cheapest, therefore the most common finish. The putty is gauged with plaster, putty alone being useless for this class of work. The proportions are 3 parts of fine putty gauged with 1 part of fine plaster. As this stuff will not stand scouring, it is difficult to obtain a true and uniform hard surface with it; and unless it is quickly trowelled before set, the surface is apt to peel in places, while excessive trowelling kills the plaster and renders the surface soft. It is best laid in two coats—the first with a panel or a hand float to lay it fair, and the second with a trowel to lay it smooth, each coat and the trowelling and polishing off to follow each other in quick succession before they set. This work must be carefully brushed, to avoid a coarse surface.

HARD FINISH.—This is used for the best class of work, and requires a special setting stuff, termed "fine setting stuff." It is made with finer sand and lime putty than that used for ordinary setting stuff. The sand must be well washed through a fine sieve until free from mud and foreign matter. The putty should be run through a fine hair sieve at least three months (the longer the better) before being required for use. While the putty is maturing it should be kept well covered, to protect it from dust and atmospheric changes. The proportions vary (according to the quality of the limes used for the putty) from equal parts of putty and sand to 1 part of putty and 2 or even 3 parts of sand. The sand and putty should be intimately amalgamated by frequent working and beating with a larry and a wood beater. A punching box is an excellent tool for this purpose. If marble dust is procurable, add 1 part to 3 parts of the above stuff. This should not be added until the stuff is required for use. The marble dust renders the stuff tenacious and hard. It is gauged in the proportion of 1 part of fine plaster to 3 parts of fine setting stuff, and laid with a skimming float, ruled fair with a straight-edge, and then quickly and lightly scoured with a panel float, using a little soft-gauged stuff to fill up any small holes. Follow on at once with the trowelling, using water sparingly, and finish by brushing first diagonally both ways, then crosswise, and finish lengthwise with a damp brush, and finally in a similar way with a semi-dry brush. This class of work is suitable where a hard surface is necessary, also for small or intricate panels, where it would be difficult to work a hand float. When finishing small panels with any kind of gauged stuff, the worker requires a keen perception of the suction and setting powers of the materials, also dexterity and lightness of touch, to preserve the mouldings from injury and obtain a fair and fine finished hard surface.

FINE FINISH.—This can also be used for the best class of work. The stuff for this is the same as the above, with the addition of 1 extra part of sand—preferably silver sand. This stuff is used

neat, *z. e.*, without plaster, and a portion is mixed with one-tenth part of well-beaten white hair and used for scratch coating. A scratch coat of this haired stuff is first laid with a skimming float. Over this, and while green, a coat of unhaired fine setting stuff is laid. This surface is carefully ruled with a straight-edge, being traversed lengthwise, crosswise, and diagonally both ways. The whole surface is then scoured up without water, but simply using some soft stuff to fill up any small holes. After a rest to admit of shrinkage, it is then scoured up three times with water, and then trowelled continuously until the stuff becomes so smooth and hard that no impression is made on the surface by the working of the trowel. The desired degree of hardness is also known by the clear metallic and musical sound which is caused by the contact of two hard substances, the trowel and the stuff. The sound becomes clearer and more musical as the hardness increases. The surface is then brushed off with a soft damp brush—not wet—first crosswise, then diagonally both ways, and finish lengthwise, and finally finish with a semi-dry brush in a similar manner, which gives a brilliant face. This surface is true, hard, and the best for artists to paint on, as when dry the gloss goes off, leaving the best of all surfaces for paint or gilt. The hardness may be further increased by using lime water for the scouring and trowelling, but using pure water for brushing off.

CEMENT FINISH.—Panelled ceilings are sometimes finished with Parian or similar white cements. In this case the foundation coat from the lath outwards is formed with a coarse quality of the cement intended for the final coat. The working of white cements is described under their respective names.

PORTLAND CEMENT CEILINGS.—Panelled ceilings situated in a damp climate or exposed to atmospheric moisture, such as porticos or open corridors, may be rendered damp-proof and durable by using an admixture of Portland cement and coarse stuff for the foundation coats, and Portland cement, used neat, or in combination with setting stuff, for the final coat. Metal lathing makes a safe foundation for this class of work. Wood laths may also be used. In this case double laths, nailed with $1\frac{1}{2}$ -inch wrought-iron galvanised nails, are required. The laths should be the best red Baltic, well seasoned, strong, and in narrow widths, and fixed not less than $\frac{3}{8}$ inch apart, so as to afford a strong key for the first coating stuff, or, better still, to allow the stuff to be pressed through between the laths until it envelops the whole of the lath work.

The coarse stuff must be composed of thoroughly slaked lime, clean sharp sand, and strong long hair. The whole must be well tempered, and seasoned by time. When required for use, it should be retempered with a larry, and an extra quantity of hair added, to allow for the Portland cement that is subsequently added to the stuff. Five parts of this stuff is gauged with 2 parts of Portland cement for the first coat, and 3 parts of the coarse stuff is gauged with 1 part of Portland cement for the floating. The finishing coat is composed of 2 parts of setting stuff gauged with 1 part of Portland cement. This is laid, scoured, and trowelled in the same way as used for hard finish. The panels can be more smoothly and expeditiously finished by using a "limed cement." The addition of 1 part of well-slaked fine lime putty to 3 parts of Portland cement will render the finishing stuff "fat," plastic, and easy to work, and also increase the density of the work. The mouldings are roughed out with the same kind of materials as used for the floating, and finished with 2 parts of Portland cement and 1 part of fine lime putty. The cement must be sifted through a very fine sieve, and gauged moderately stiff for the first coat, and run off with soft-gauged stuff. This process gets up the moulding with a surface as smooth as glass. These materials and methods may be safely employed as an anti-damp plaster in exposed positions.

FIBROUS PLASTER PANELLED CEILINGS.—Fibrous plaster is now largely used in the construction of panelled ceilings. The panels and mouldings are made in one piece, and cast in large sections.

Large fibrous plaster slabs, decorated with low relief bands and foliage, principally in the Flemish style, are now greatly in vogue. These slabs are screwed on to the joist, also on to concrete ceilings. Fibrous panel mouldings are often screwed on to "solid work." I used fibrous plaster panel mouldings and enrichments, which were fixed on solid plaster, wood, and on ceilings and walls floated and set with Martin's cement, at the Palace Club, Westminster.

As to the relative merits of solid work and fibrous plaster, it may be pointed out that the numerous examples of old panelled ceilings throughout the country which are still extant show little or no traces of time; but there are no ancient examples of fibrous plaster in the United Kingdom which can be used for comparison. Fibrous plaster has the advantage of being light, dry, and quickly fixed, and it can be painted before or as soon as fixed; but it may be safely said that solid or lime plastering will remain the staple material and process for most permanent purposes. The following illustrations of working plans of panelled ceilings are given as a practical supplement for working panelled ceilings.

CEILING OF KING CHARLES' ROOM, WINTON HOUSE.—A perspective view and plan of a part of the ceiling in King Charles' room, Winton House, near Edinburgh, built in 1620, is shown in Plate XXX. It is a fine example of old hand-worked plaster, the rib and panels being decorated with free and effective foliage, and the deep and well-balanced pendants lend a bold effect. The frieze is of rare design, and is a fine example of the arcaded form. According to tradition, this ceiling, and the drawing-room ceiling in the same house illustrated on Plate XVI., were executed by Scotch plasterers who had acquired the art of ornamental plastering from the French plasterers employed in the plastic decorations of several houses in Edinburgh for the Scottish nobility about that period, though Messrs Macgibbon and Ross consider them to be of English origin, and Billing points out that the same details are used at Pinkie and Moray, and argues that the same plasterers executed all three. The geometric formation is common to many English ceilings of this date. There are no records existing or other definite evidence to demonstrate the methods used by plasterers of the long past for the execution of the numerous elaborate and beautiful plaster ceilings which still exist in many mansions. These examples prove that they were grand geometricians, who also knew how to select and manipulate the necessary materials, so as to obtain beautiful effects and enduring results.

A working plan of this ceiling is given, to show what would be the modern way of setting out and working. Take the design to be contained in a square between the points A, A, A, and A, and the panel B as the centre, it will be seen that this square is again subdivided into six smaller squares on each side, making thirty-six squares in all, which form the design or pattern before being repeated. The centre lines, marked 1, 2, 3, 4, 5, 6, and so on, as shown on the sides and ends, form the small squares, and are repeated as often as required, according to the complete design and size of the room. Besides being centre lines, they also give the centres of the B and C panels, the pendants A, A, A, A, and the centres (*d*) from which the segments (*c*) are struck. The diagonal lines in the B panels give the position and fixing points for the centre pattern. The diagonal lines may be extended the whole width and length of the room, to prove the intersections of the B panels, and the centres of the pendants A. Having set out and proved the skeleton lines, the working lines are next formed, and then the running rules fixed. The running rules are first fixed to run all the longitudinal mouldings in one line from one to the other end of the ceiling. Where practicable, all those rules should be fixed at one time. This allows all those mouldings to be in hand at one time, and the roughing out and finishing to be completed in each individual operation, thus saving repeated mould muffling and changing of materials. It will be understood that the rules are not

fixed in short lengths, or in other words, a separate rule is not fixed for each separate length of moulding, but that they are fixed in continuous lengths the full length of the ceiling, which gives better results. The rules need not be in one piece the whole length of the ceiling, but may be made up in 10 or 12 feet lengths. Rules cannot be fixed in a continuous line on a ceiling having moulding or pendant brackets, and in some instances, where they are diagonal or circular mouldings, which cross the right-angle mouldings. In some cases it is advantageous to run those or other mouldings first. Long lengths of moulding are generally run first, but no hard and fast rule can be given. This, like many other plastic problems, is solved by the exigencies of the case and the intricacy of the design. After the longitudinal mouldings are run, the rules are taken down and fixed for the mouldings that cross the ceiling, or at right angles with the longitudinal mouldings. For instance, in this ceiling the rules are fixed to run all the longitudinal sides of the B panels, and the sides of the longitudinal C panels. After the mouldings are run, the rules are taken down and fixed for running all the other sides of the B panels and sides of the C panels that run across the short way of the ceiling. The circular ribs (*e*) and the short straight ribs (*f*) are run down, *i.e.*, on a bench, then cut to the lengths, and mitred and planted. The ribs (straight on plan and circular on section, as shown at the pendant), which spring from the intersections of the *e* ribs to A, are run down on a cradle and planted. If there are no wooden brackets on the ceiling to act as a bed bracket, or for the four ribs, it will be best to set them in position on a cradle, piece-mould the whole, and cast and plant them in one piece. An allowance must be made for an iron pipe or bolt (threaded at the ends) to pass through the work, so as to secure the pendant. The four leaves are cast and fixed, and finally the pendants, thus completing the ceiling. A sketch of the pendant and a section of the panel moulding is given; also a scale of equal parts, to assist in any required enlargement. The scale is one-half of the pattern taken between A and A. This is divided into ten parts, which, if required, can be again divided into minutes. Having decided on the required size, take the half of the pattern and divide it into ten equal parts, and measure all other parts from that scale.

CEILING AT CAREATH HOUSE.—The annexed illustration (No. 20) shows the plan of a part of a ceiling at Careath House, Ayrshire. The house was built in 1847, from designs by Mr D. Bryce, architect, Edinburgh. The plaster work was done by J. Ramage & Son, my father being the foreman. One-half shows the centre and radial lines (the centre lines are made thick to better show the design). The other half shows the centre and width lines. In this example the semicircular ribs (whose centres are A) are run first, this being the reverse of the preceding ceiling. It is well known that straight mouldings are far easier to mitre than circular mouldings, hence the reason for running the semicircles first. They are run a little beyond the line of mitre, so as to allow for a mitre joint to be cut out of the solid. The straight part can be run, and then mitred up to the circular mitre joint. The short straight pieces are then run down, cut to the mitres, and planted.

The semicircle ribs are run from a "radius pin" (R.P.). This is a block of wood about 6 inches square and $\frac{1}{2}$ inch thick, with a hardwood pin about 2 inches long and $\frac{1}{2}$ inch diameter fixed through the centre. The whole resembles a miniature hawk. This is fixed on the ceiling with screws, the true centre being obtained by keeping the four angles in a line with the four right-angle centre lines, as shown at R.P. A hole to fit the pin is made in the radius rod, thus forming a centre and guide for running the circular ribs. The use of a "radius pin" is far better than fixing a centre pin through the lath work. The latter way is apt to break the lathing and floating, and the true centre is not so easily obtained. After the circular ribs are run, the rules are fixed to run all the B, C, and D mouldings from point to point. After these are run, the rules are fixed to run all the E and F

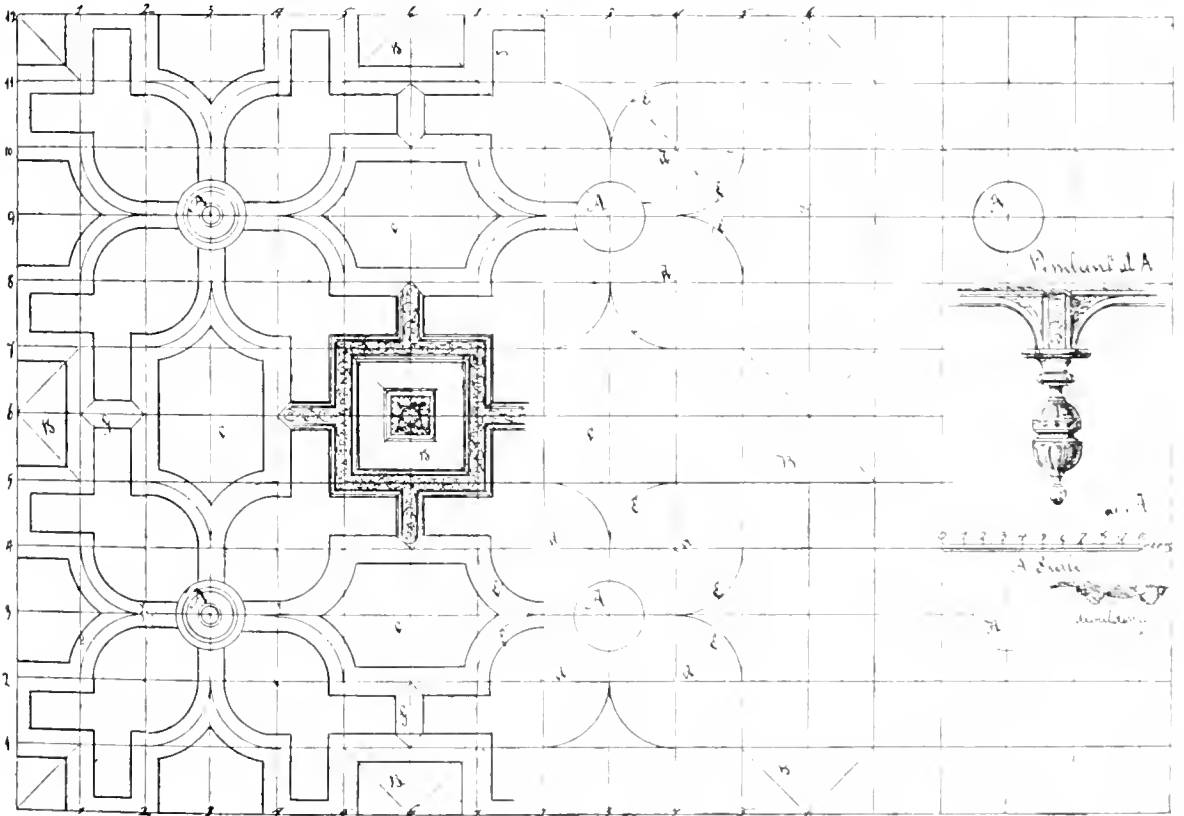
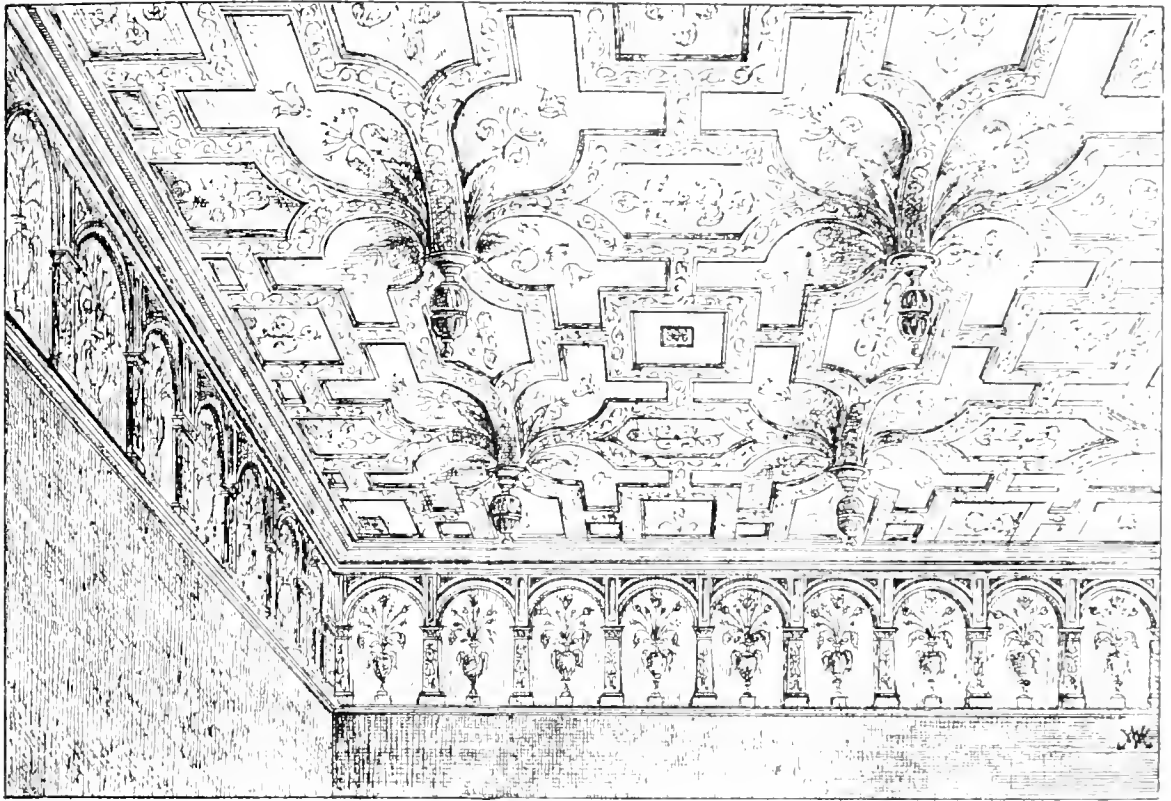

PERSPECTIVE VIEW OF PLASTER CEILING IN KING CHARLES' ROOM, WINTON HOUSE, MIDWORTHIAN, 1020.—With working Plan.

mouldings. Then the short lengths, G, H, and I, are run down and planted. With a few exceptions, all mouldings over 1 foot long are run *in situ*. The square pateras or shields (J) are cast and planted. Their positions and centres are got by placing the angles of the cast in a line with the right-angle lines. The pendants (P) are cast and planted. Their positions and centres are got by temporarily fixing four nails in a circle line previously made on the ceiling, or by four quarter marks cast with the pendants, and then placing the marks in a line with the centres of the intersecting mouldings.

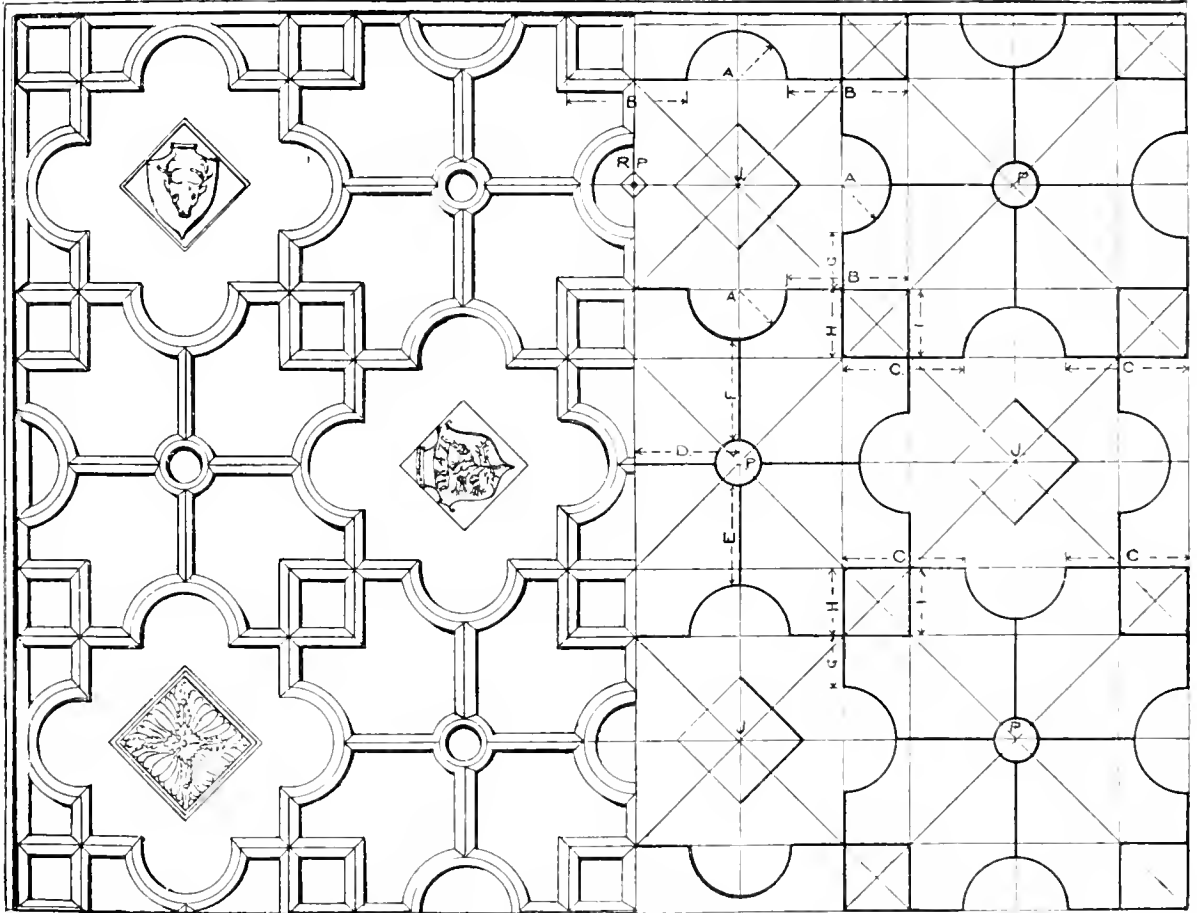

NO. 20.—PORTION OF A PLASTER CEILING, CAREATH HOUSE, AYRSHIRE, 1847. WITH WORKING PLAN.

CEILING AT BEESLACK.—The annexed illustration (No. 21) shows the plan of a portion of a ceiling in Sir John Cowan's house, erected in 1855, at Beeslack, near Edinburgh. The plaster work was executed by J. Ramage & Son, my father being the foreman plasterer. This was the first job on which I tried my "prentice han'" on the scaffold. As this ceiling is drawn from memory, I am not certain if there were pendants, as shown, or if the ribs were simply mitred. The method of setting out this ceiling is similar to the other geometrical designs which have been described. The figures 1, 2, 3, 4, and 5, at the side and end, indicate the working and centre lines of ribs, which at their intersections form a series of equal-sized squares, extending all over the ceiling from cornice to cornice. The figure or design is contained between the lines 1 and 5. Diagonal lines drawn from the angles of the square of the design give the centre lines for the diagonal ribs D and the

pendants P. To find the centres c for describing the segmental ribs (S), bisect the lines which form the small squares, as shown. Segmental ribs, if small, are run down, cut to the desired sizes and mitres, and planted. When cutting segmental ribs, such as in the present example, care must be exercised to cut them to the exact length and mitre, so as to avoid mitring the circular moulding

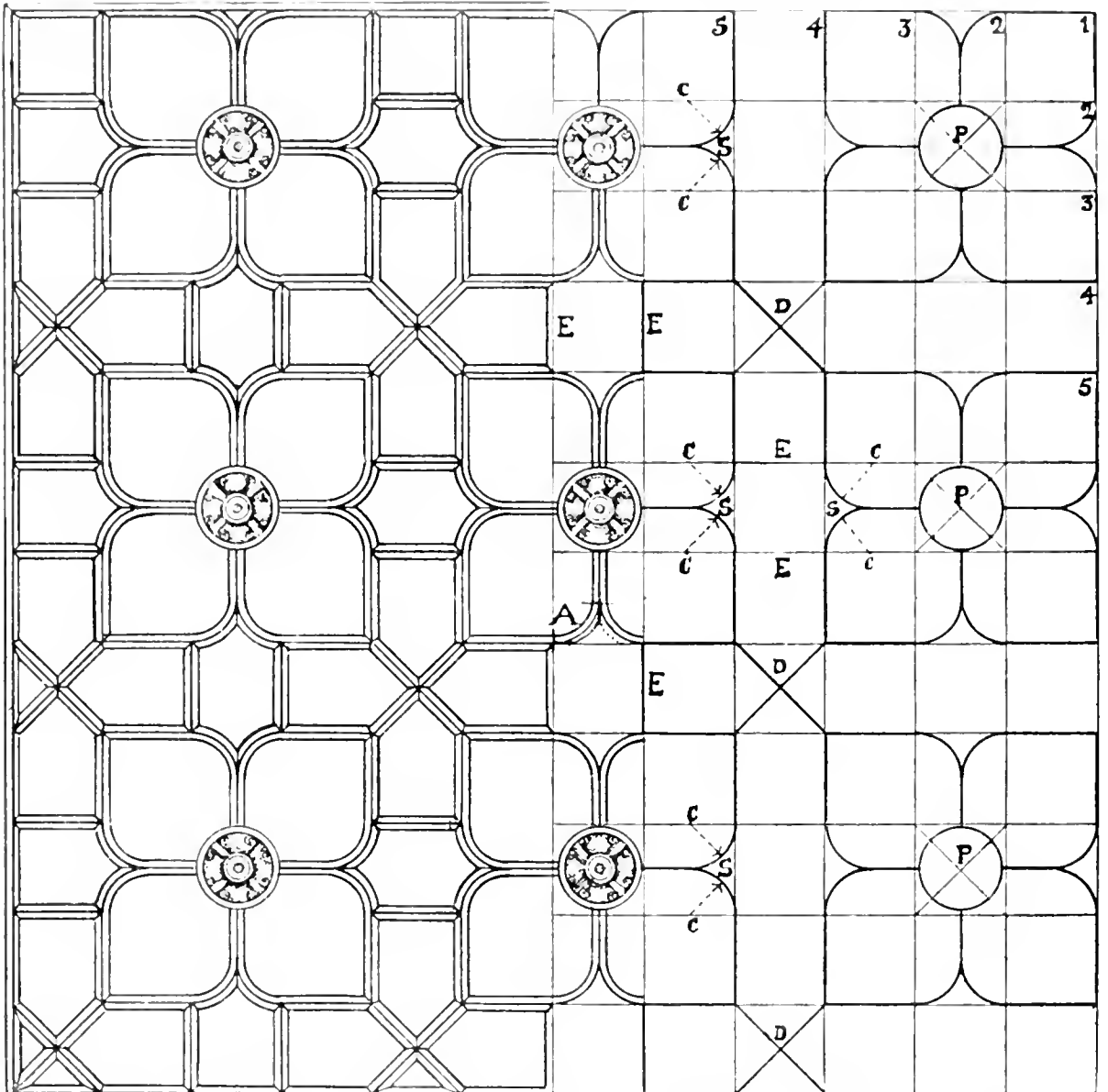

NO. 21.—PORTION OF A PLASTER CEILING, BELSACK, MIDGHTON, 1855. WITH WORKING LINES.

or making an unsightly joint between the circular and straight mouldings. If the moulding is cut to the exact size, and with clean square joints at the ends and sides (as shown at A), the pieces will fit close and intersect true with the straight moulding, and will require only a little stopping to make the intersection good. Having set out the working lines, fix the running rules to run all the long mouldings that run longways, and then run the long mouldings that run crossways, as already



PLASTER CEILING, PRINCE SIRKLI, BEIRUT, 1885

described. The cross short ribs (E) and the diagonal ribs (D) are next planted. The segmental ribs are planted last. The pendants are fixed after all the other parts of the ceiling are finished. Pendants that are fixed before other parts of the ceiling are finished are liable to get displaced or otherwise injured, especially if they are large or depend deep downwards. It is advisable to run as much of the work as possible, as it is generally stronger and more expeditious than running it down, and having the extra labour of planting each separate part. Short ribs should only be run down and planted where the mitres would be as long as the piece run. If short ribs are accurately cut to size and mitre, little or no mitring will be required, and a little stopping will make the mitre good.

CEILING AT EDINBURGH.—Plate XXXI. depicts a ceiling in a shop at Princes Street, Edinburgh. This ceiling was designed by Mr D. Bryce, architect, and executed in 1850 by J. Ramage & Son, and the modelling by W. Gillies, my father being the foreman plasterer. This elegant ceiling is in the Elizabethan style, and is remarkable for its free and open panelling, and its numerous pendant pateras, one being placed at every mitre. The fine and bold centrepiece depends about 3 feet in depth. The main cornice is enriched with a fine running frieze ornament and other enriched members, the whole being supported by pilasters with enriched capitals.

CEILING IN THRONE ROOM, HOLYROOD PALACE.—This ceiling, Plate XXXII., was designed by Mr A. Mathison for the New Throne Room, which was reconstructed in 1854. The dimensions of the room are 59 feet 4 inches long, 37 feet 7 inches wide, and 19 feet 10 inches high. The plaster work was executed by J. Ramage & Son, and the ornament designed by W. Gillies and modelled by the author, this being my first attempt for public work. The whole of the plastering and modelling was carried out under the supervision of my father. It is said that the ceiling was designed under the supervision of the late Prince Consort. This may account for the initials P. A. appearing in one of the panels near the throne. All the lettering on the shields and ornaments read from the throne end of the room—V.R. on the right, P.A. on the left. In the centre line, and hidden by the canopy of the throne, comes first a large square, in which are the rose, thistle, and shamrock, with crown above; next, in small circle, the shamrock; then a large circle, with St Andrew's Cross on shield, encircled with "Nemo me impune lacessit"; followed by a smaller panel, with crown, and a centre, the royal arms. The next large circle panel is the St George's Cross on a shield, with ribbon encirclings, on which is "Honi soit qui mal y pense"; then comes a smaller circle panel, with shamrock; and last, at end of each centre line, a large square which is a repetition of that over the throne. Across the centre line, in the centre of the royal arms, the large circle panel has on the shield a sceptre, crowned, from which branches the rose and thistle, with two crowns below, encircled by "Tria juncta in uno." The opposite circle has the same motto, with three crowns on shield. The design or pattern of the ceiling repeats itself four times, the royal arms being the centre. The ceiling is painted and grained to imitate oak, and the idea has been so well executed as to deceive many visitors as to the actual material employed. The enrichments are further decorated with colour and gilding. The ceiling ribs are about 5 inches by 4½ inches. The main cornice is about 1 foot 9 inches on the wall, and is enriched with a perforated cove ornament, consisting of the rose, thistle, and shamrock, and foliage encircling a thick straight stem.*

CEILING AT LIVERPOOL.—In some designs the panel surfaces between the ribs are enriched with foliage, &c., leaving little or no plain surface, as shown in the annexed illustration (No. 22). This shows the plan of a part of ceiling at Olympia, Liverpool, executed in fibrous plaster by J. Davis.

* This photograph, and that from which Plate XVII. has been reproduced, were taken by W. H. Davies, Edinburgh, by special permission of the Lord Chamberlain, for publication in this book only, and are strictly copyright.

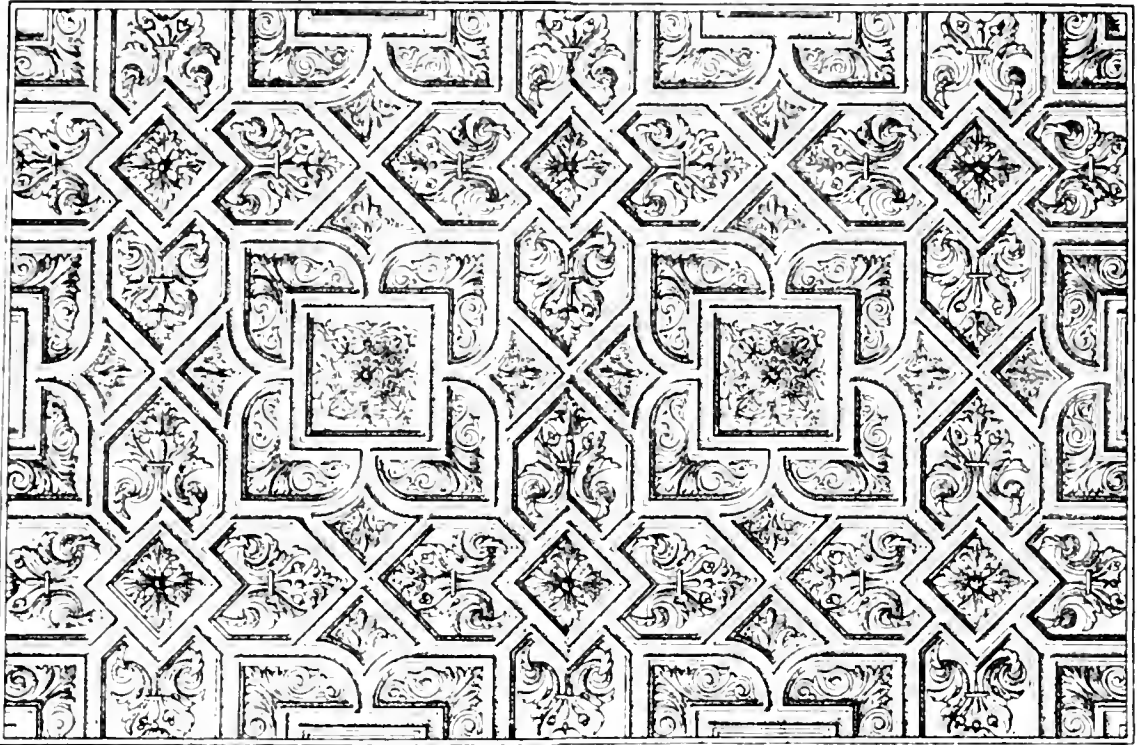

NO. 22.—PORTION OF A FIBROUS PLASTER CEILING, LIVERPOOL, 1890.

When constructed in the old or solid way, the mouldings are run first, leaving a sufficient depth for the thickness of the ground on which the enrichments are cast. The enriched grounds are then planted, and the joints made good. For fibrous work, the combined mouldings and enriched panels are cast in large sections, and then screwed up in position and the joint stopped. When setting out the ceiling for fibrous plaster, care should be exercised to form the joints of the moulding piece at the parts least seen and most easily made good. The panel enrichments in this ceiling are modern, but the geometrical design is old, and has been reproduced in several districts with and without enriched panels.

CEILING AT BRADFORD.—The annexed plate XXXIII. shows the plan of the drawing-room ceiling in a house at Bradford, erected in 1879. The plaster work was done by T. Cordingley & Sons, and I am responsible for the modelling items. The design is in the Adam style. The room is 19 feet 6 inches by 14 feet 3 inches, as marked on the plate. The space in which these dimensions are figured represents the width of the cornice. Beyond this cornice at one end of the room is shown the ceiling of the oriel window. One-half of the finished ceiling is shown, and the other half illustrates the method of setting out, and shows the centres and figured lengths of each radius for the oval, circle, and segmental panels. The centres for 15 feet 10 inch radius for the side segments, and the 8 feet radius for the end segments, cannot be shown in the sketch. These and the oval moulding are run from templates which have been previously set out on a floor. The small circular mouldings are run with a radius rod mould. Great care is required in setting out a ceiling of this kind to ensure the various mouldings intersecting truly and correctly, especially at the four small circles, which intersect at the centre of widths of mouldings, and with the centre

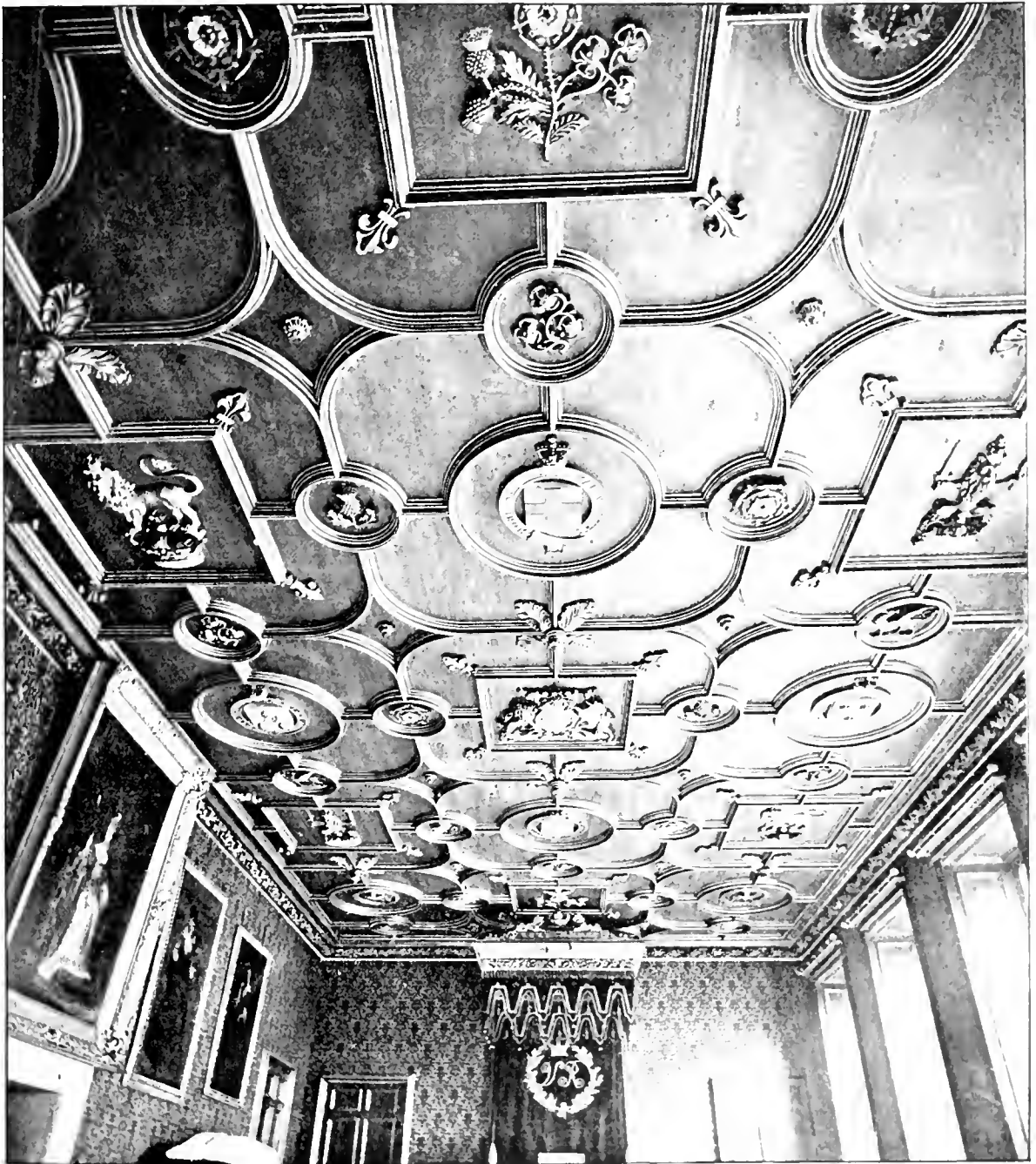

PLASTER CEILING, THRONE ROOM, HOLYWOOD PALACE, EDINBURGH, 1854

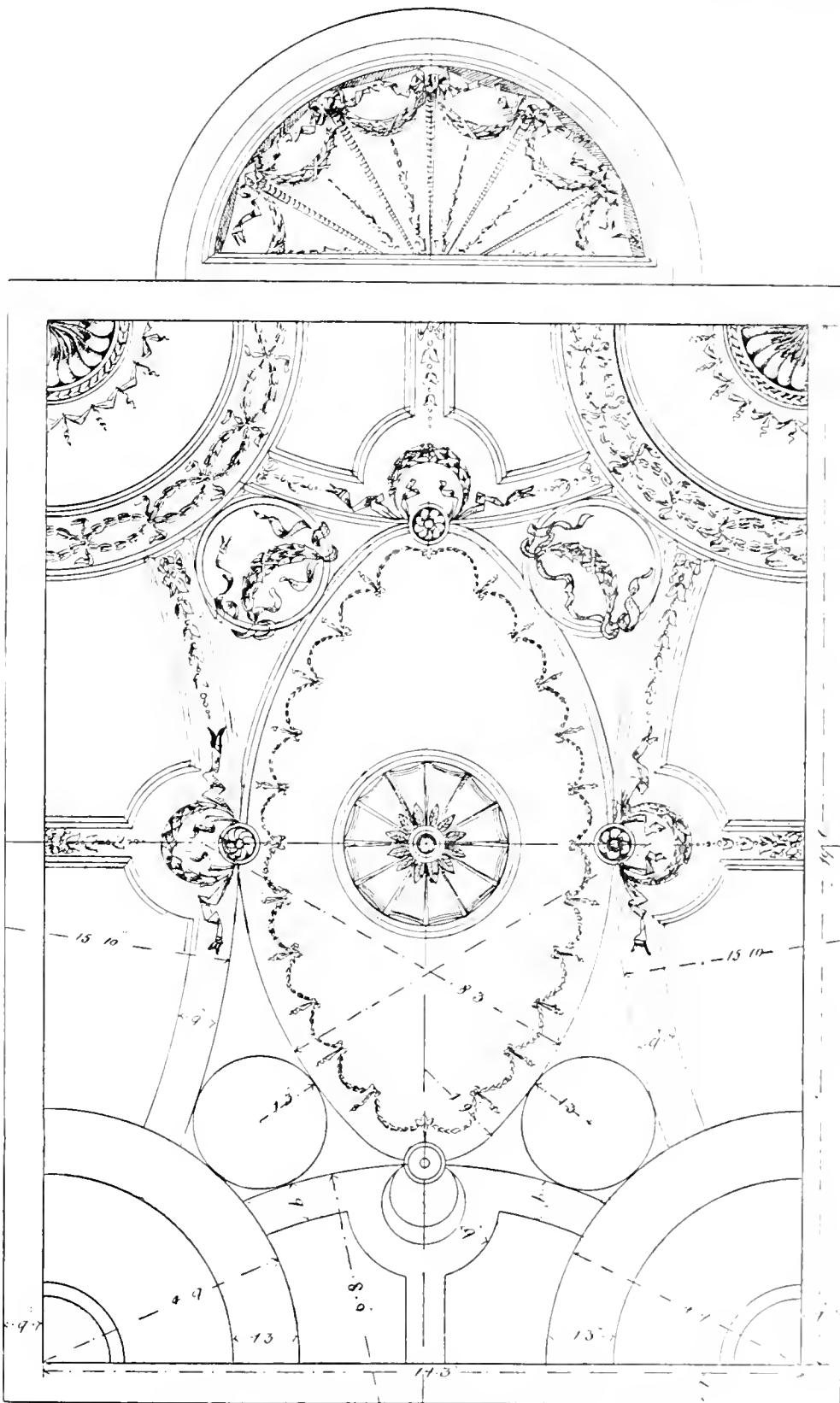

PLASTER CEILING AT BRADFORD, IN THE "ADAM STYLE," 1770.

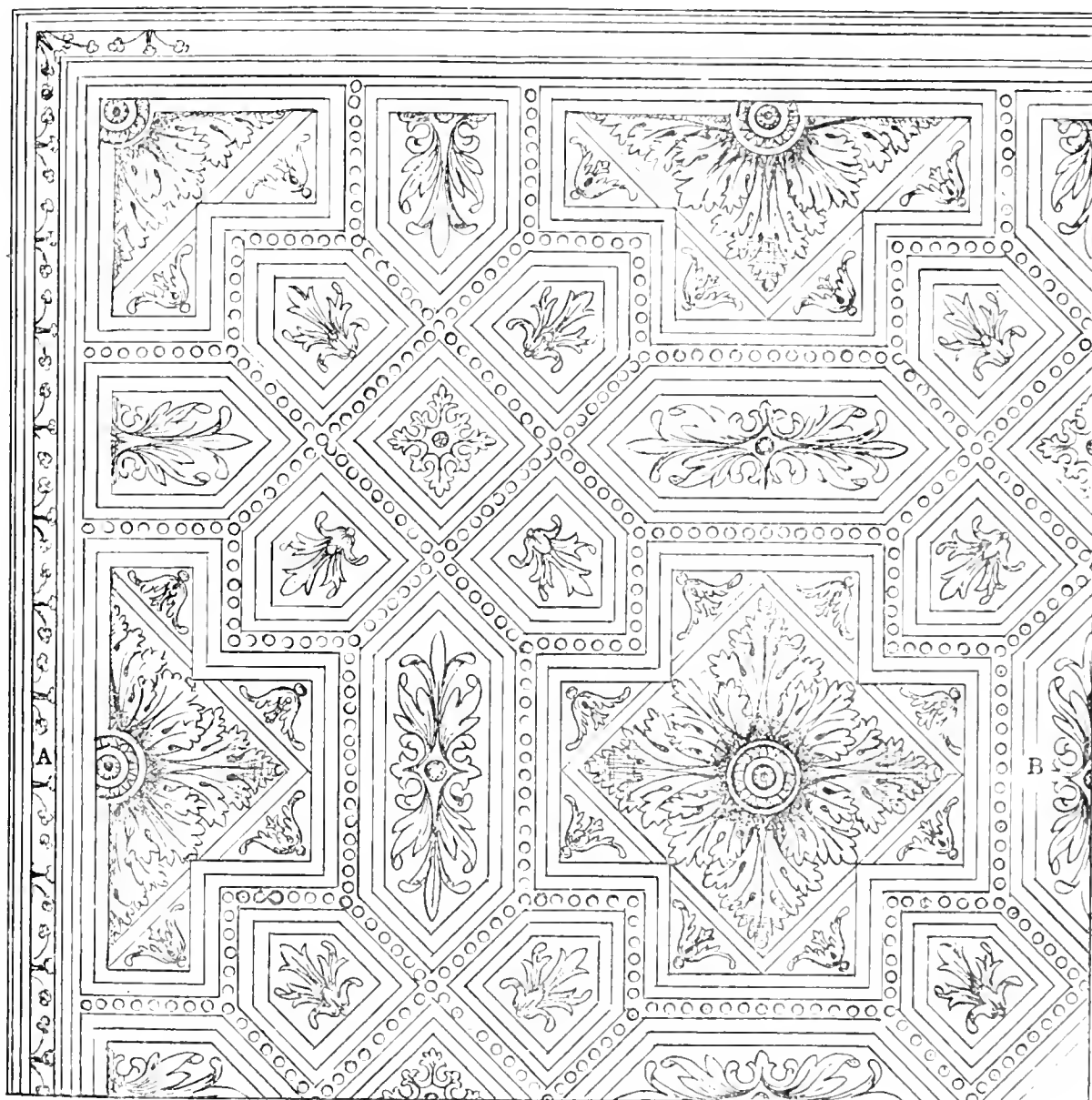

Plan

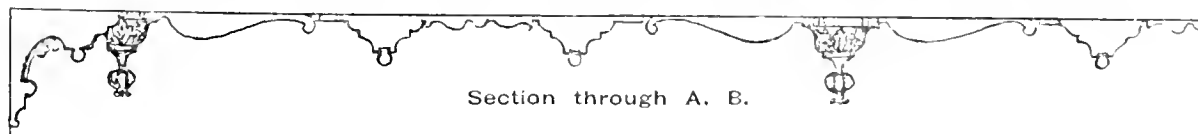

Section through A. B.

NO. 23.—PORTION OF A PLASTER CEILING, DUBLIN, EARLY NINETEENTH CENTURY.

of widths of the four others. The ceiling over the semicircle bay window is filled in with modelled fibrous plaster work.

CEILING AT DUBLIN.—The annexed illustration No. 23) shows the plan and section of a part of a ceiling in a house at Dublin, executed in the early part of the present century by

J. Hogan, a well-known Dublin plasterer. Hogan, assisted by his sons, did some fine plaster work in Dublin and other parts of Ireland; but owing to a lack of appreciation of good work, or through plaster work being undertaken by builders or general contractors, the Hogans have practically been displaced from the trade. The panel mouldings were run *in situ*, and the panel enrichments were cast and planted, and the beads in the panel mouldings and the cove enrichment were stamped and finished by hand. A section of the ceiling, through A B, showing the "centre pendants," is given.

CEILING AND WALL DECORATION.—The annexed plate (XXXIV.) shows a part of a drawing-room ceiling and wall decoration in Hill Park House, Forfar. This fine modern mansion was designed by Messrs Boucher & Cousland, architects, Glasgow. The prettily designed plaster work and modelling was executed by J. Steel in 1870. The main feature in the ceiling is the large oval-shaped moulding, with set-offs or breaks. The centre is ornamented with a very elaborate centre flower (but not shown in this view). The outer panel surface is enriched with diaper work in low relief. The main cornice is of a very elaborate nature, being fully enriched. The walls are panelled in Keen's cement, and have enriched angles. Small circular panels containing busts are placed between the main panels. The columns and pilaster, with their pedestals, are composed of Keen's cement. The highly ornate mirror over the chimney is composed of carton-pierre and paste composition. A fine example of decorative plaster work is depicted on Plate XXXV. This shows a portion of staircase landing over the entrance hall in Mr W. Macfarlane's residence, Park Circus, Glasgow, designed by Messrs Boucher & Cousland, architects. The beautiful modelling and plaster work was executed by Mr J. Steel, Glasgow. This is a fine example of elliptical arching in a semi-Gothic style. The medallion busts represent Mr W. E. Gladstone and Sir W. Armstrong. The elaborate moulded and fluted columns are composed of Keen's cement, and are marbled and polished. This mansion was erected in 1880.

GOTHIC CEILINGS.—Pure Gothic was first used in the thirteenth century. It is said that the last epoch of true Gothic may be dated in the sixteenth century, or immediately before the introduction of Italian architecture, which was made by John of Padua and other foreign artists.

Walpole's eloquent writings in the middle of the last century won many admirers for the Gothic. The celebrated villa at Strawberry Hill is an example of Walpole's taste. It is said that Robert Adam designed one of the ceilings. The building began in 1750, but was not completed until 1776. Those who desire to fully appreciate the beauties of the Gothic style should read Mr Ruskin's glowing essay on the "Nature of Gothic Architecture." There are also fine examples of Gothic architecture in Scotland, Ireland, and Wales. It will neither be irrelevant nor uninteresting to enumerate some examples that are prominent in plaster work. The Gothic plaster preceptors of the past generation also demand a passing notice.

CEILING AT TODDINGTON.—Plate XXXVI. depicts the plan of a part of the drawing-room ceiling, Toddington, Gloucestershire, and Plate XXXVII. shows the same ceiling in perspective. This very elaborate mansion was designed in the Tudor style by the proprietor, Lord Sudely. Owing to its pronounced Tudoristic points, it has been termed by some critics as the "Tudor of Tudors." The building was begun in 1819, and took over twenty years to complete. There were no master-men, no sub-contracts or piecework on this gorgeous edifice. The whole work was done by the day, under the personal supervision of Lord Sudely, assisted by Stephen Price, the clerk of works. The timber, stone, limestone, and oak for the lath work were all found on the estate. The gypsum for the plaster was brought from Spurnal, Worcestershire,

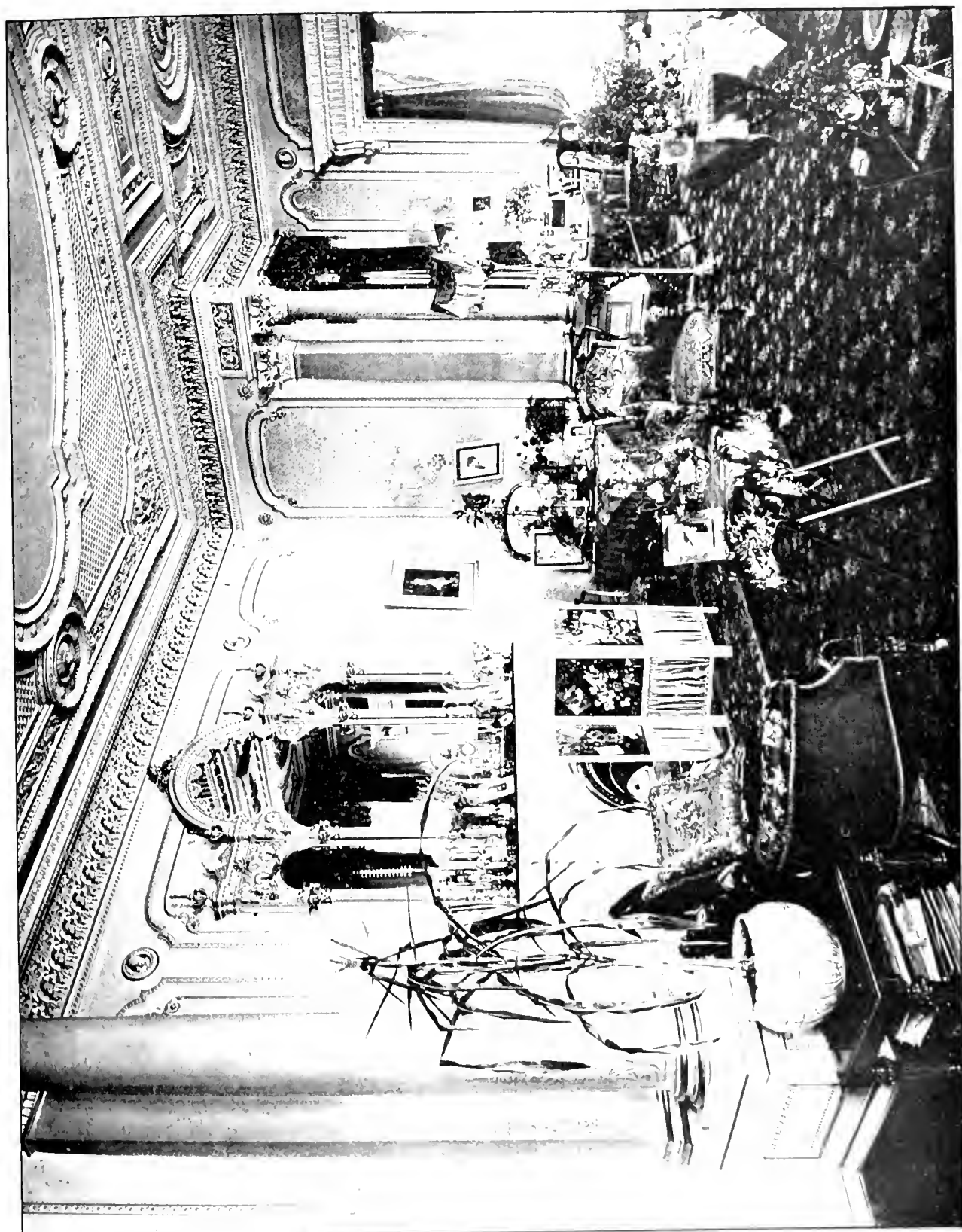

PLASTER CEILING AND WALL DECORATION, HILL PARK HOUSE, FORBES, SCOTLAND, 1870

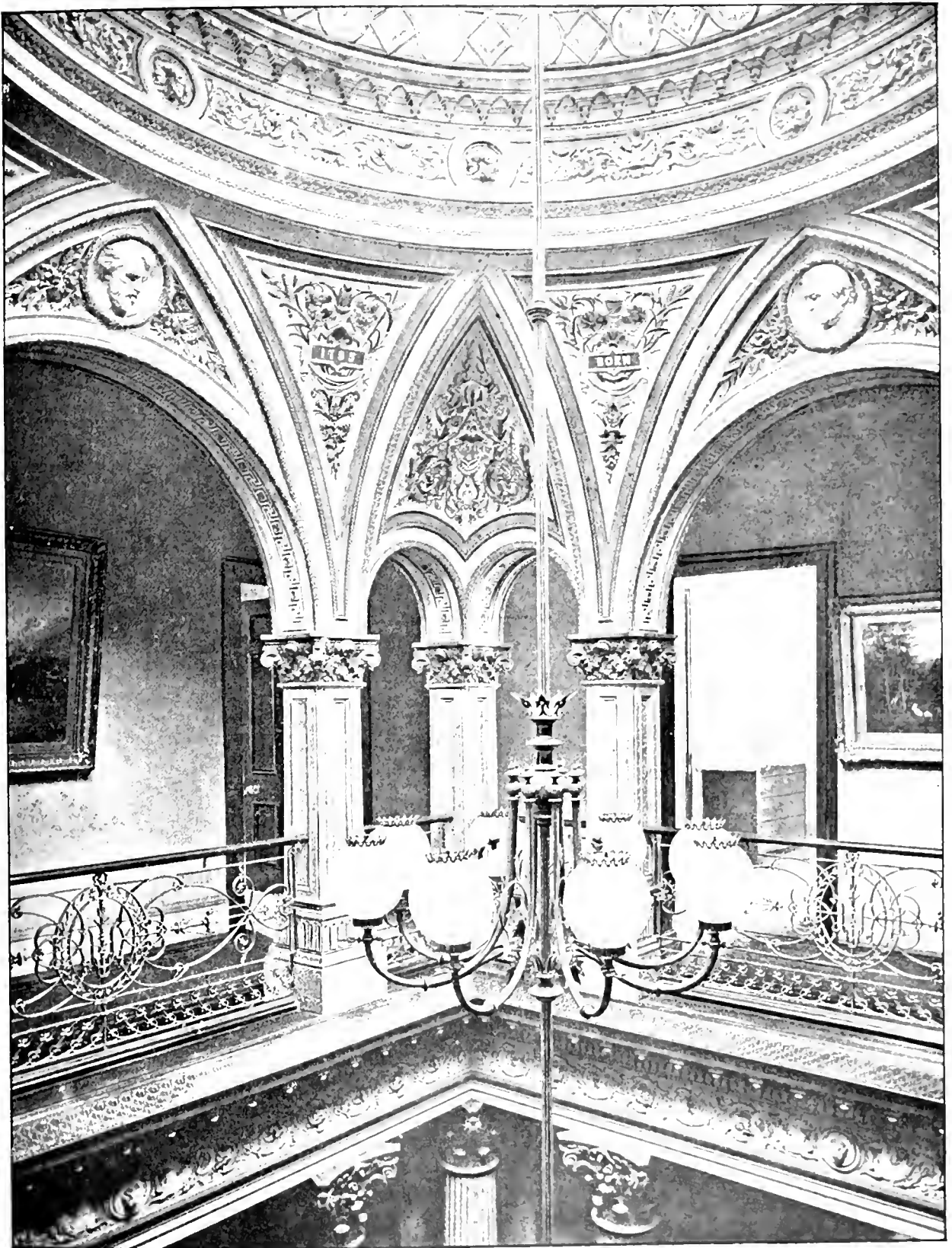

DECORATIVE PLASTER WORK, IN STAIRWAY OF THE FINE ARTS BUILDING, UNIVERSITY OF CALIFORNIA, BERKELEY, CALIF.

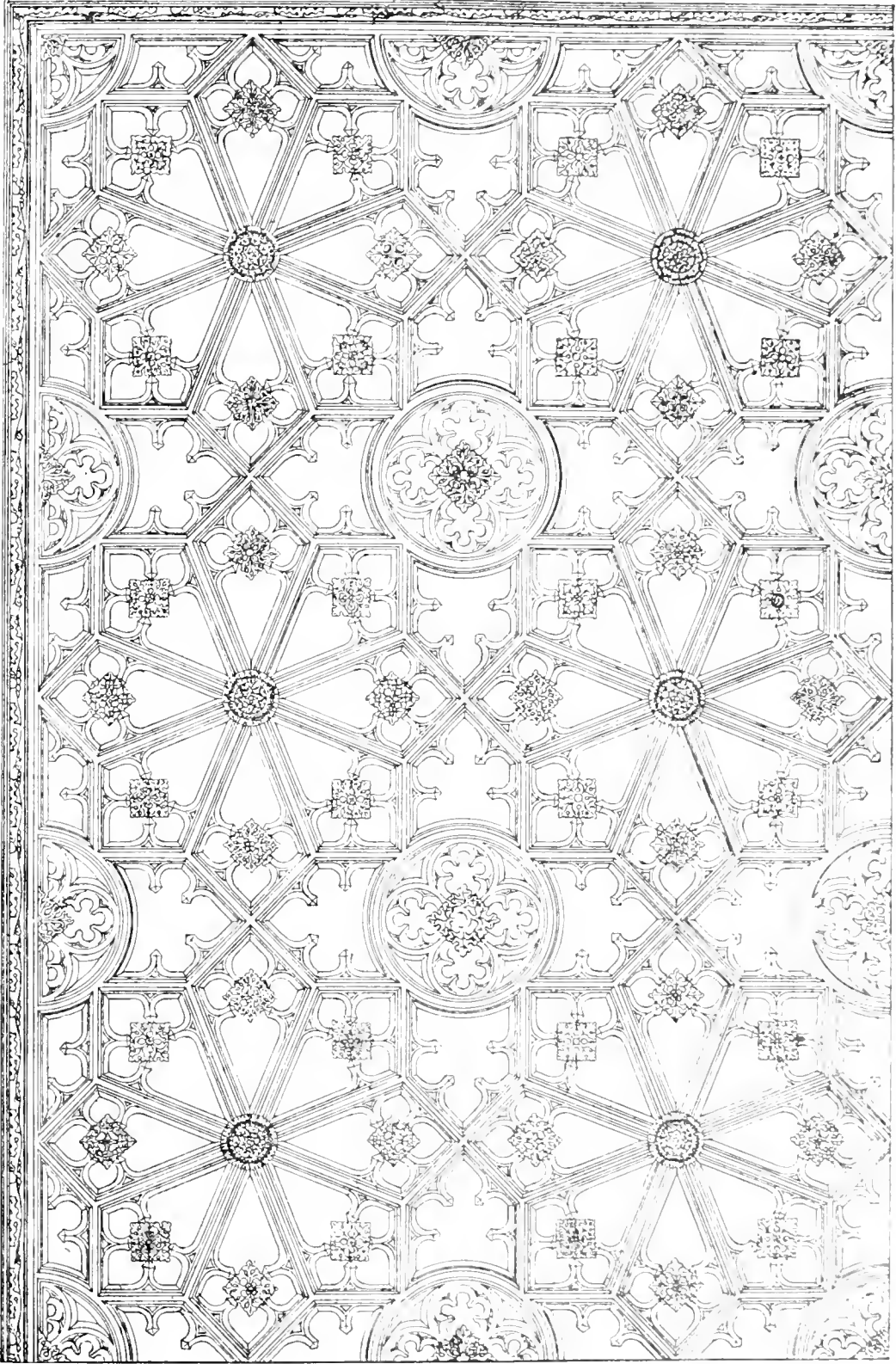

FULL PLAN of DRAWING-ROOM CEILING at FORDINGTON, GLOUCESTERSHIRE, 1810.

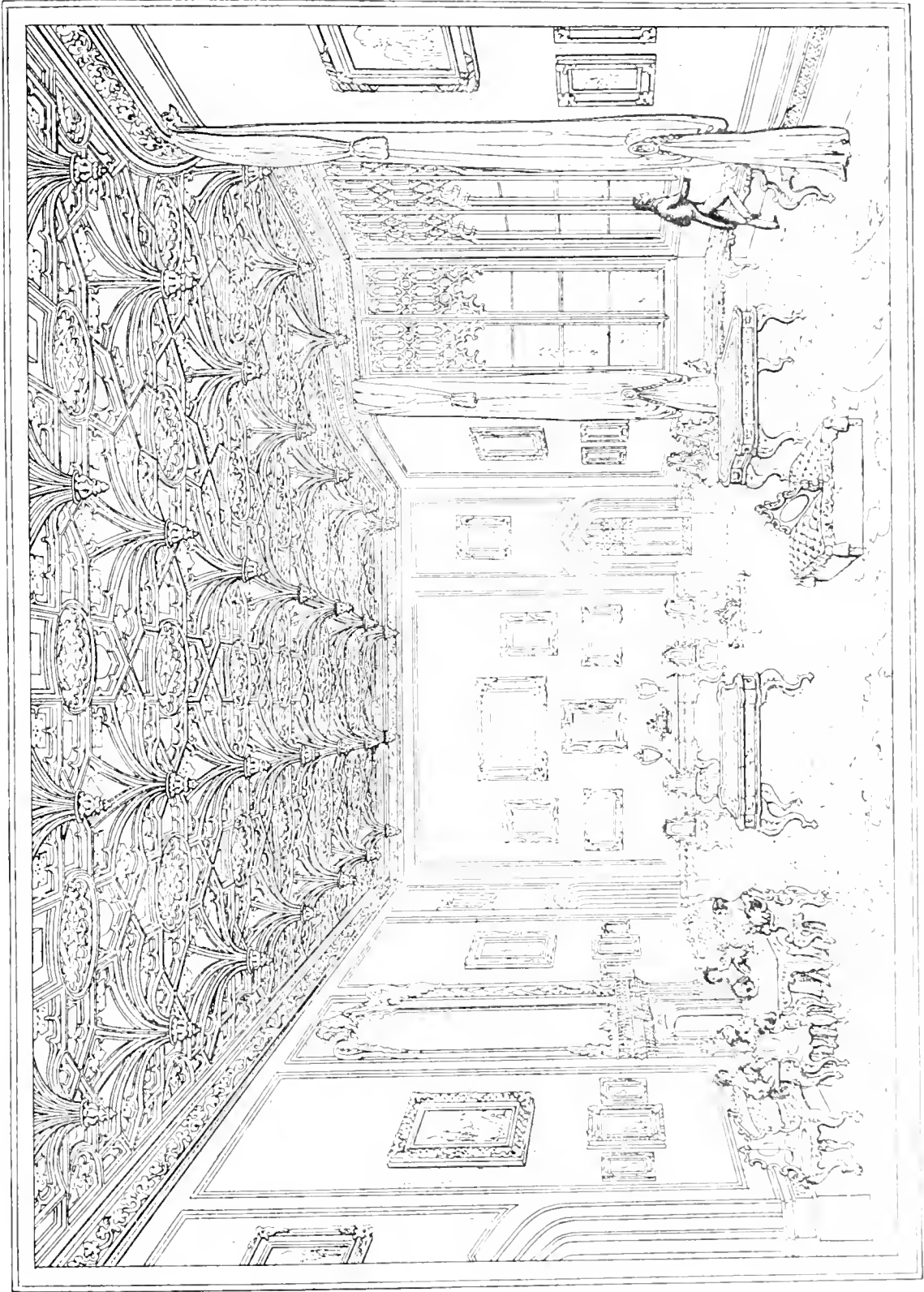

PERSPECTIVE VIEW OF DRAWING-ROOM AT TODDINGTON, GLOUCESTERSHIRE, 1810.

and baked and ground on the site. James Robbins, of Cheltenham, was the foreman plasterer. His son James had a rare experience on this job, as he not only served his full apprenticeship, but also worked as a journeyman. The length of time taken for plaster work is accounted for by the fact that although there was such a vast amount of work, very few men were employed. Plaster models were made for the principal wood, stone, and iron work. These served to show the effect of the design, and allow for alterations before being finally committed to the more expensive materials. These plaster models, after the design was approved of, were used as models for the wood, iron, and stone work. Plaster models are used for this purpose in most good works, Gothic or otherwise. There are several elaborate plaster ceilings in this mansion, some in imitation of stone, and some in conjunction with wood. The drawing-room is 40 feet long, 30 feet wide, and 20 feet high. The pendentive ribs are internally supported by iron pipes. J. Robbins, the one-job apprentice, after leaving Toddington, came to London, and was employed by Bartlett, a modeller and plasterer, and eventually became a clerk of works. His brother Edwin is well known in London as a clever but eccentric plasterer, who plods in plaster and patents.

MODERN GOTHIC PLASTERERS.—F. Bernasconi was a great master of Gothic plaster work. He flourished in the latter part of the last and the early part of the present century, and he did some fine work throughout Great Britain and Ireland, notably the grand staircase at Windsor Castle, finished in 1801, and at Fonthill, designed by James Wyatt; also at Taymouth Castle, the seat of the Earl of Breadalbane, designed by Elliott. The grand staircase in this last castle is said to be the finest in Great Britain. It is 40 feet square, and 80 feet high. Among Bernasconi's pupils may be mentioned Taylor, Herbert, and Parish, of London; also J. Annan, of Edinburgh. The latter was the grandfather of the present J. Annan, of Edinburgh and London, who is well known in the trade in connection with his numerous works of plaster throughout the three kingdoms. T. Jones, of Liverpool, has executed some fine Gothic plaster work in England.

Rule, of Durham, mastered the method of Gothic plaster work at Ravensworth Castle, the seat of Lord Ravensworth, a building begun in 1808, from drawings by J. Nash. Ferguson, of Carlisle, was initiated into the details of this branch of plastic work at Lowther Castle, Westmoreland, which was designed by Sir R. Smithe, and the work commenced in 1808. It is said that the grand staircase is the largest in England. It is 60 feet square, and 90 feet high. Parsons, of London, was a skilled plasterer, well versed in Gothic work. He was employed at Ashbridge, the seat of the Earl of Bridgewater. This mansion was designed by J. Wyatt, and the building begun about 1814. This is said to be the most magnificent of modern Gothic mansions in England. R. Evans, of Swansea, practised Gothic plaster work at Margam, in South Wales, a house designed in the Tudor style by T. Hopper.

Pitts, Smith, and the elder Naimby did some of the modelling for the wood, stone, and plaster work of the Houses of Parliament. H. Mabey was the shop foreman, and Blunt the scaffold foreman, on Sir Charles Barry's masterpiece. Mabey was the progenitor of a clever race of London modellers, and Blunt's descendants are also well known for their modelling and plastering abilities. Tom Garland was a past master modeller not only in Gothic but in most other styles. Garland, who was popularly known as the father of modellers, was often engaged by Thomas Cubitt and W. Cubitt. He was also well known to Sir Charles Barry, Digby Wyatt, Gilbert Scott, and other leading London architects.

Eaton Hall, Cheshire, the seat of the Duke of Westminster, was designed by W. Porden. The building was commenced in 1803. This gorgeous mansion contains some highly decorated plaster ceilings, and has four clustered columns, supporting a vaulted ceiling covered with a

profusion of rib tracery. At one end of this apartment is a sub-library, of an octagonal form (30 feet diameter), which opens to a second library (37 by 20 feet). The drawing and dining rooms have elaborate ceilings; the corridors have splendid groined ceilings. Some of the ceilings are highly enriched between walnut beams, and others are decorated with rich rib tracery and bosses, also with numerous shields, coats of arms, &c. A portion of this marvellous plaster work was done under the supervision of H. Mabey, who, I believe, was a relative of C. H. Mabey, the well-known modeller, of London. J. Annan, of Edinburgh, also did some of the Gothic plaster work, J. Donald being the foreman. Messrs Smith & Taylor did another portion of the work. Mr F. J. Curley did the modelling.

Sir Walter Scott's house at Abbotsford has some fine Gothic work. The great author, in conjunction with Mr Atkinson, was responsible for the design, and the plaster work was done by J. Anderson, Edinburgh. There is a fine example of Gothic plaster work in Mr Graham's house in Albany Street, Edinburgh. The plaster work was executed by J. Ramage, and the modelling by R. Foster. There is an interesting example of Gothic work in a house near Edinburgh, said to be designed by Kemp, who designed Scott's Monument. The plaster work was executed by J. Ramage & Son, and the modelling by R. Foster. It was at this job that my father, fresh from Caputh, Perthshire, made his first attempt in Gothic plaster work. On the death of Mr Ramage, Foster and my father succeeded to the business, and did many plaster jobs in the Gothic and other styles. W. Baird, of Edinburgh, was also an expert in Gothic modelling and plaster work. There are some fine examples of Gothic work in Glasgow. Amongst them may be enumerated St Matthew's Church, St Peter's Church, and Anderston Church. These were built about the middle of the present century, and the plaster work, as well as in several other Gothic jobs, was done by Joseph Leach. W. Leckey was the foreman plasterer. Part of the modelling was done by James Leckey, and the other part was done by James Steel, of Glasgow. On those churches and other Gothic work J. G. Smythe served the greater part of his apprenticeship, and was often employed six continuous weeks in mitring long intersections of clustered rib mouldings. Smythe is now well known in London as a sound practical plasterer. J. Steel, the above-mentioned modeller, who was born at Dundee, 1819, where he served his apprenticeship, had an intimate acquaintance with the principles, spirit, and details of Gothic work. He eventually became a leading master modeller and plasterer in Glasgow. Two examples of his work are given herein. His son James displayed great talents as a modeller, and after a brief sojourn in London he commenced business in Glasgow, but was cut down in the flower of his youth and abilities. His business was taken up and is still successfully carried on by his foreman, R. A. McGilvray, and R. Ferris, a pupil of J. Steel, and a clever and artistic modeller. Caird & Darion were also noted in Glasgow for their abilities in Gothic and classic plaster work. Hogan, of Dublin, was proficient in Gothic plaster work. The elder Hogan worked with the brothers Clark. The fine Gothic plaster work at Longnor Hall, Salop, was executed by W. M. Wellings, whose sons are now well known as prominent plasterers in Shrewsbury and surrounding districts.

GROINED CEILINGS.—In order to render the method of setting out and constructing groined ceilings clearly, an example of one is here given. Plate XXXVIII. shows the elevation and the plan of one-half of a groined ceiling in Trinity College, Glenalmond, Perthshire. The founders of this college were Mr W. E. Gladstone and Dean Ramsay, of "Reminiscences of Scottish Character" fame. The late Mr T. Henderson, Edinburgh, was the architect, the plaster work being done by J. Ramage & Son, and the modelling by W. Gillies. A. Millar, of Blairgowrie, an uncle of mine, was the foreman plasterer. The building of this college extended over a period of four years, and

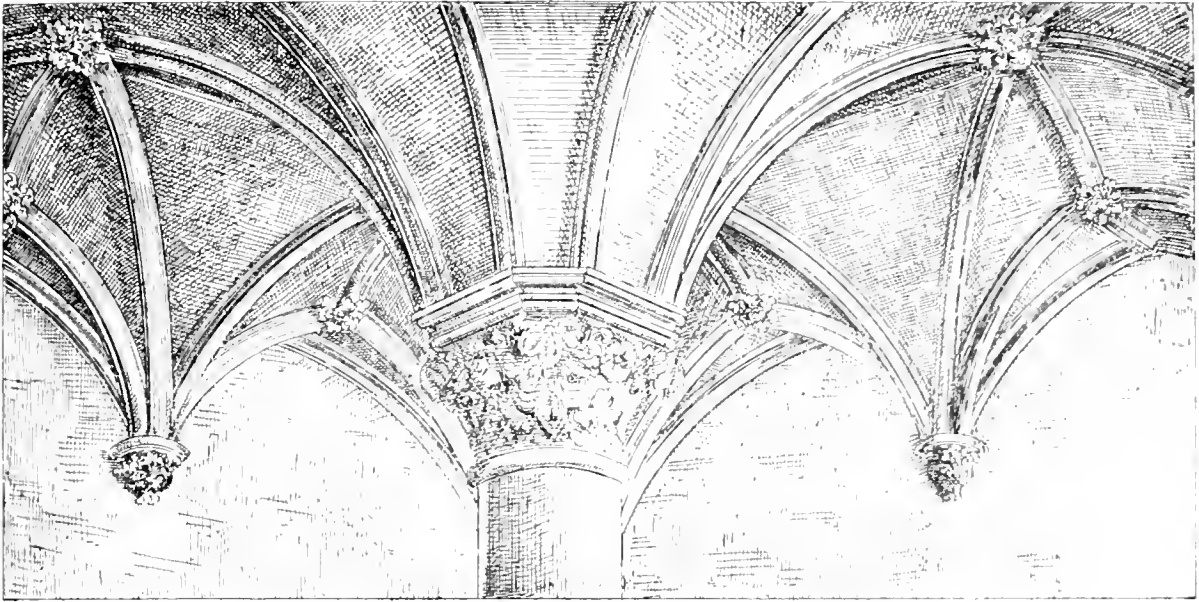

ELEVATION.

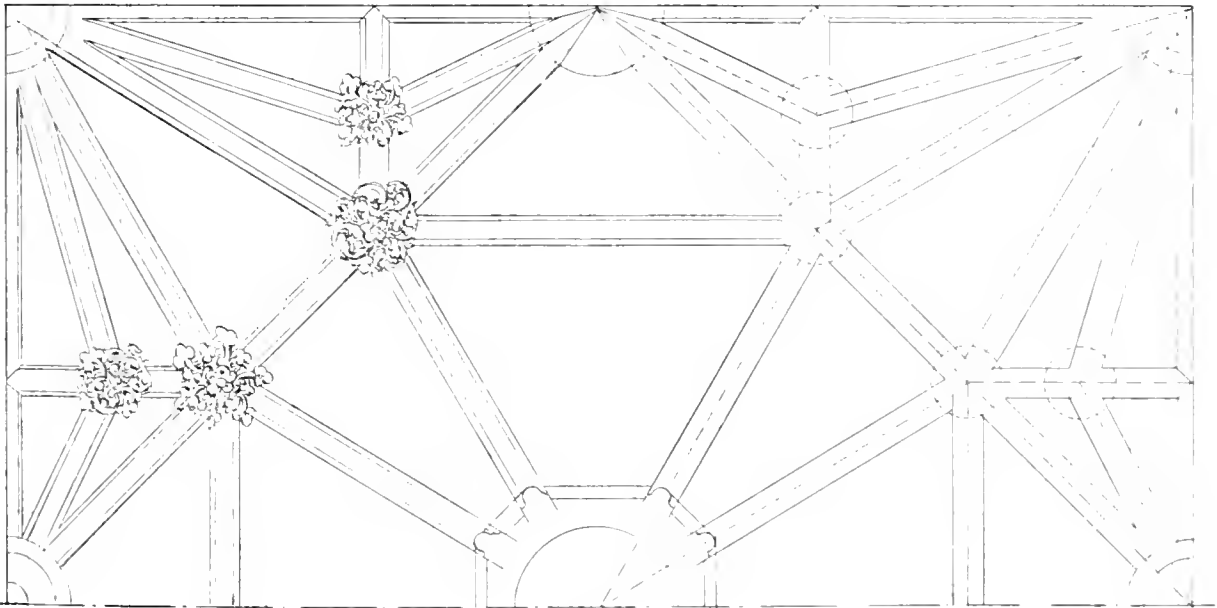

HALF PLAN.

GROINED CEILING, TRINITY COLLEGE, PERTHSHIRE, 1845.

was finished in 1847. The style is in the Perpendicular period of English Gothic. It will be seen that the vaulting and rib mouldings spring from or are supported by a main or centre column, while the other ends of the ribs are supported by corbels, as shown on the plan and elevation.

It is in Gothic work that a man's knowledge of drawing and practical geometry is of special advantage to him; but it must be admitted that there is in most cases a foundation prepared for him either by the carpenter, bricklayer, or mason, who has had to set out the various curves and lines for the constructional work. A knowledge of drawing and geometry will enable the plasterer to set out his own lines required for templates and centres. It may be taken as a general rule that the lines for vertical and diagonal mouldings are obtained by stretching a chalk line from the springing of one side of a cove, arch, or barrel ceiling to the springing of the other side, and hanging a plumb-line from the crown and other places of the circular work in hand. The work is set out from a level datum line, which is struck on or just above the main cornice, or at the springing of the vault.

The springing and intersections of the various mouldings according to the design are set out and divided from the datum line. It will be understood that this datum line is carried all round the room. A centre line on the intrados is required for setting out and showing the intersections, centres, and positions of mouldings. The following is the truest and most speedy method of running ribs on groined ceilings. First set out a datum line at the springing of the ribs. If there is a cluster of ribs, fix an intersection board at the springings. The intersection board is made of stout deal, and on it the plan of the ribs is set out, also the position of the foot of the template. Templates are made with one or more pieces of timber, according to the length. They are from $1\frac{1}{2}$ inches to $2\frac{1}{2}$ inches in thickness, and from 4 inches to 8 inches deep, according to the size of the rib. They are planed smooth and true on the running sides and edge. Care must be taken when setting out the template to allow a sufficient mould space between the running edge and the centre member of the rib. This space is to allow a free passage for the centre part of the mould, also for the bearing pins which are inserted in the slipper. The pins enable a mould to take any form or number of curves on a template. The template is fixed with screws on the intersection board at the springing, and secured at the crown with a jack. A cluster of ribs intersecting would in the ordinary way require two screeds for each rib, and each rib being on a different angle, would necessitate a special curved floating rule for each set of screeds. This may be entirely avoided, and the vertical and diagonal screeds formed true and expeditiously, by running a narrow screed when running the ribs with the running mould. The running mould is so formed as to have a sufficient bearing on the template. After the ribs are all run, vertical or horizontal, pressed screeds are formed at various points with rules of different lengths, and bear on the run screeds, after which the different bays are floated and set as desired. Right and left diagonal ribs require right and left moulds. The following illustrations elucidate the various parts of the jack and the template, which, when combined, form a "jack template."

JACK TEMPLATE.—The annexed illustration, No. 24, elucidates the construction and method of working a jack template. The jack is an iron frame with screws, and is used for fixing and holding the template or running rule in position when running Gothic ribs, mouldings on groined ceilings, also for external and diagonal rib mouldings on large coves and vaulted ceilings. The template has already been described. Fig. 1 shows the section of jack and template *A* in position. *G* is the frame of the jack. This is formed with bar iron about 2 inches wide, and from $\frac{1}{4}$ inch to $\frac{1}{2}$ inch thick. The top plate of the jack *TR*, which has to carry the whole weight of the template and running mould, should not be less than $\frac{3}{8}$ inch thick, and be well welded or riveted to the

ends of the frame (G). The centre bolt (A) is about $\frac{3}{4}$ inch thick, and made sufficiently long to give a good hold in the ceiling. This bolt is fixed in the eye or centre of the rib's intersection. When there is a series of ribs intersecting at one point, the centre bolt is kept in position till all the ribs are run. The jack is turned round to the desired angle, to receive the template for running each separate rib. When in position, it is further secured by two $\frac{1}{2}$ -inch screws, as shown at F, F. The template (A) is regulated and held in position by the side screws (D, D) and the bottom screw (C). These screws are about $\frac{1}{2}$ inch in diameter, each with a square head (in some cases a thumb plate) for turning purposes, and on the point an iron grip plate, to ensure a firm hold on the template. The position of the template at the springing is determined by means of the rib section (J), and the position at the crown by the centre bolt (A), which is the eye or centre of the rib, and the intersection of all the ribs. The template's position is further proved by holding up the running mould at the springing and crown, to test the centres and depth of the rib. Fig. 2 is the side elevation of jack and the template; A, G, and C being the same as in Fig. 1. The other parts in this sketch are as follows:—

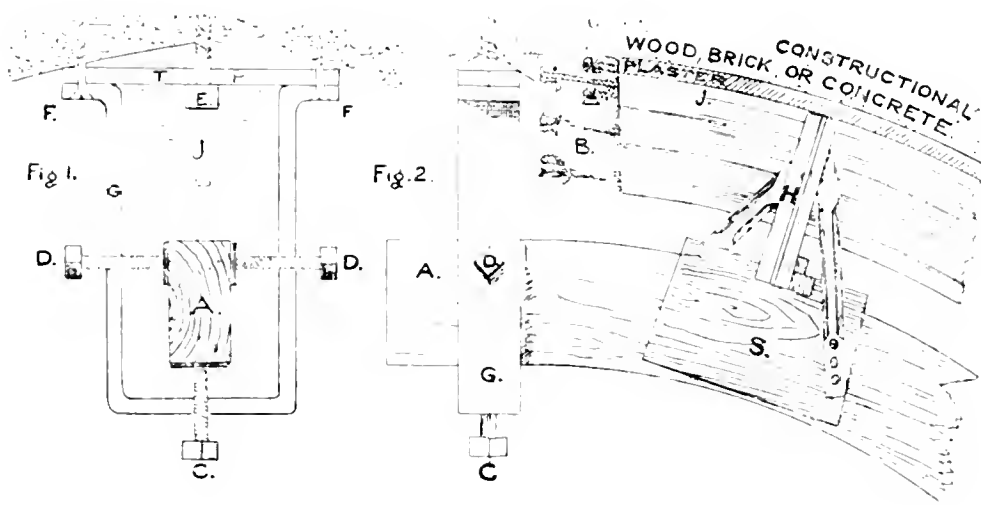

NO. 24.—JACK TEMPLATE AND SPIKE AND ROPE BRACKET.

"SPIKE AND ROPE BRACKET."—A portion of this kind of bracket is shown at B (Fig. 2). One row of long spikes forms the depth, and two rows of short spikes form the width of the bracket. One row in the centre is sufficient for small rib mouldings. The spikes are fixed from 6 to 12 inches apart, or according to the joints, curve of the rib, and the requisite strength for the bracket. The spikes are made with a taper, or with notched sides, to prevent the ropes from slipping down, and with a broad head to prevent them slipping off. The spikes, before using, must be galvanised, or soaked in boiling linseed oil, to prevent rusting. After the spikes are fixed, strong tar bands or ropes are twisted round the spikes from one to another, until the whole length of the row is completed, and so on in the same way with the other rows. This forms a strong and expeditious bracket, adaptable for any curve, and giving a good key to the roughing-out material. A further key is obtained by cutting out the joints of the constructional work, or the floating from lath work, as the case may be, and brushing and well wetting the bed of the moulding. H is the running mould in position, S is the slipper—this mould is described on p. 146, J is one-half elevation of the rib.

INTERSECTION BOARD AND SLAB.—Illustration No. 25, Fig. 1, shows the plan one-half of an intersection board, where the ribs spring from an isolated column. This intersection board is made for four ribs. Intersection boards are used to set out the positions and sizes of the ribs and templates, and to help to support the latter. The radius of the column and cap are indicated by the dotted circle lines. The straight lines which radiate from the centre give the intersections and centres of the rules (J,I,J). I is the intersection board, the A's are the feet of the templates, and are held in position by the wood fillets (K). H is the plan of mould, s the slipper, and P the bearing pin. A running mould for this class of work is made with a double stock. This sketch II, only shows one, so that the plate can be seen as fixed before the second stock is screwed on. The

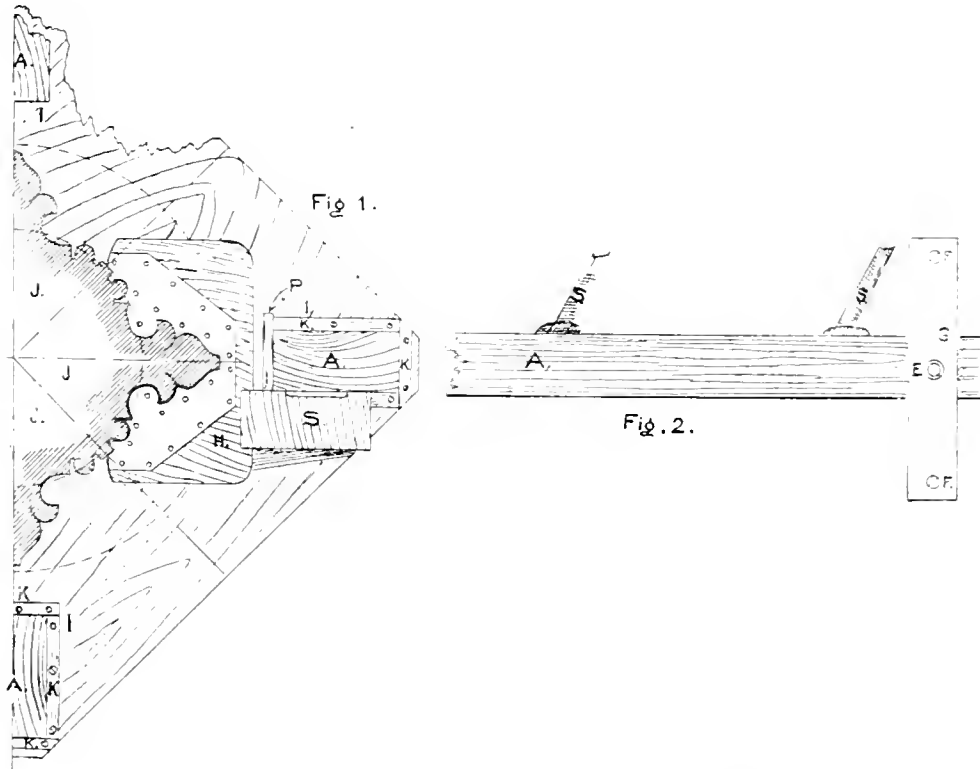

NO. 25.—PLAN OF INTERSECTION BOARD AND JACK TEMPLATE.

plate is made in two pieces to allow the two sides to be placed together in a vice, and cut and filed true to each other. Fig. 2 shows a plan of the template at the ceiling end. s and s are wood stays to steady the template while the ribs are being run. They are placed at intervals on the off-side, when the ribs are run in halves, and are fixed with plaster gauged with lime putty water. The other letters in this diagram correspond with the letters in Figs. 1 and 2 on illustration No. 24.

RIBS AND PIN MOULDS.—Illustration No. 26, Fig. 1, shows the elevation of the run ribs and intersection board, and sections of the template and jack, plans of which are shown at Fig. 1, illustration No. 25. Long templates are made in three or more pieces, as shown at A. The B's are temporary wood brackets to support the intersection board. The space between the lowest member of the rib and the upper or running edge of the template A is where the bearing pins of the running moulds work. Fig. 2 shows the plan of an intersection board, where a cluster of ribs spring from an engaged column or a corbel on a wall. In this example there are three full ribs

and two half ribs. *I* is the intersection board, the *A*'s are templates, and the *J*'s the ribs. The same method is adopted for any number of ribs. Fig. 3 is a view of a double-stocked running mould. The method of making was partly described when dealing with the mould shown in Fig. 1 on illustration No. 25. This form of mould being narrow and weak at the lowest member, is strengthened by the brace (*B*). The slipper (*S*) is made extra deep so as to give a counterpoise to the half of the mould on the off-side of the template. The bearing side of slipper is hollowed

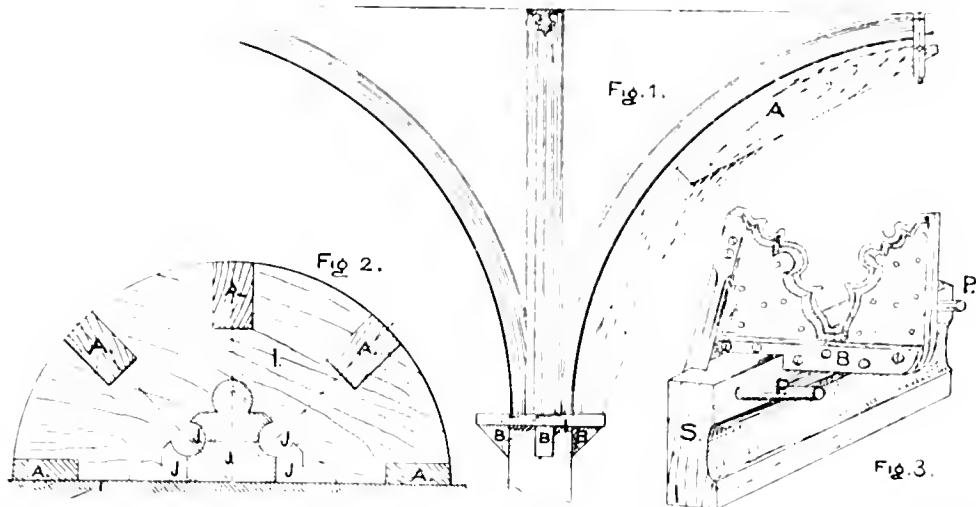

NO. 26. FIG. 1. ELEVATION OF RIBS. FIG. 2. PLAN OF WALL INTERSECTION BOARD. FIG. 3. PIN-MOULD.

out, to give less friction and a more steady bearing. The two bearing pins (*P*, *P*) are made of hardwood; each is about $\frac{1}{2}$ inch in diameter. No screeds are required in this method. A narrow screed for floating from is formed by the two nibs of the mould. Gothic ribs, 2-foot girth, have been run by this form of mould and template.

HALF-RIB PIN-MOULD.—A perspective view of a half-rib pin running mould is shown in the annexed illustration, No. 27. This form of running mould is used when the moulding is run in two parts, or one-half from each side of the template. The circular “nib-slipper” (*H*) is generally used when running half ribs, and also for running parts of ribs. *S* is a wood stay fixed to the handle and the stock, to steady the deep part of the mould-plate.

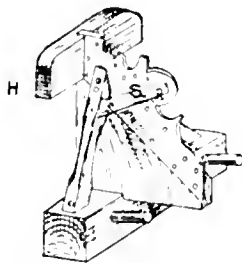

NO. 27.
HALF-RIB PIN-MOULD.

MITRING RIB INTERSECTIONS.—Where three or more ribs intersect at one point, a long mitre is unavoidable. In some rib intersections parts of the mitre may extend several feet in length, and where the members are undercut and intersect with each other considerable time and skill is required to make the intersection mitre true in section and line. If there are no brackets, the centre rib may be run nearly all the way; but where there are brackets, the mould cannot be run farther than where the side ribs intersect. In this case it is often advisable to cut the brackets at the intersections, to allow the centre rib to be run as far as possible, and save unduly long mitres. When the side or diagonal ribs are being formed, the mould cannot be run farther than where the intersection begins. In this case, the whole or a part of the bracket should be cut off where required, to allow the running mould to be run down as far as possible. Another way to avoid long mitres is effected

by cutting a template or running mould, having only the centre member, or as much of the side members as can be freely run down to the foot of the ribs. After the centre members of the rib are run, the side members are formed with templates, made to bear on the parts run. The various members of the ribs are run as far down as possible, and then the whole is finished by hand in the ordinary way. A good method for long circular mitres of this kind is to cut a plaster template to fit the end section of the rib, and then fix it on the intersection board, or at the foot of the rib, to act as guide or bearing for the joint rule. Two or more wood joint rules are usually required for mitring rib intersections. One should be cut to the ground section, and one to the outer face section of ribs. Another plan to form long mitres is to make a plaster cylinder to the curve of the ceiling, and on this run the required length of ribs, then cut them to the desired lengths and shapes, and plant them in position. Long and intricate intersection mitres are sometimes cast. A model of the full intersection is first made, and then moulded, cast, and fixed in position.

OLD GOTHIC MATERIAL.—Gauged setting stuff was often used for the finishing coat of Gothic mouldings. It attains great hardness, and gives a resemblance to the texture of stone.

CLASSIC PANELLING.—To enable the young plasterer to comprehend the various forms of panelling which are often used in the classic style of panelled ceilings, nine examples of panels with their ornamentation, from designs by Sir W. Chambers, are shown in illustration No. 28.

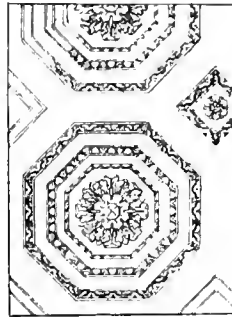

Octagons and Squares

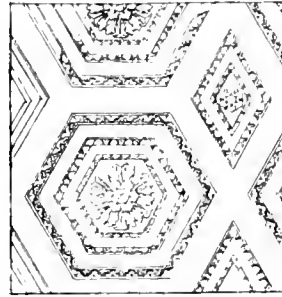

Hexagons and Lozenges

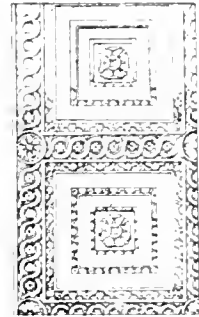

Squares with Enriched Borders

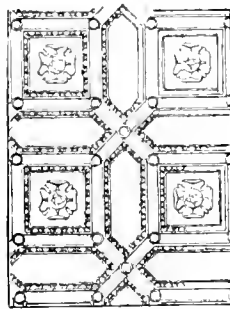

Squares, Octagons, and Hexagons

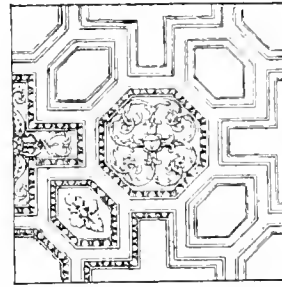

Octagons, Hexagons, and Crosses

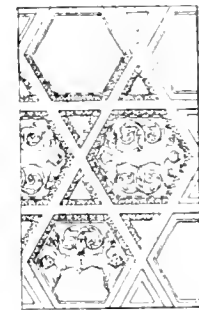

Hexagon and Triangles

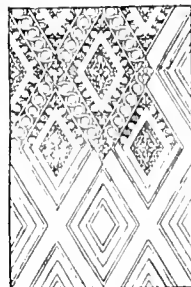

Lozenges with Enriched Borders

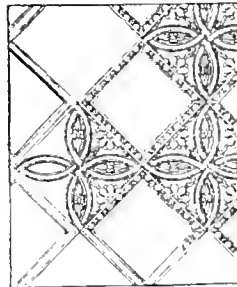

Squares and Encircled Circles

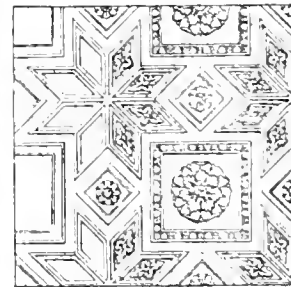

Squares and Stars, with Fleurons, &c.

NO. 28.—PANELS FOR PANELLED CEILINGS, CLASSIC STYLE.

CHAPTER VI.

RUNNING DIMINISHED AND CIRCULAR MOULDINGS.

DIMINISHED COLUMNS—DIMINISHED FLOATING RULES—COLUMN TRAMMEL—CONSTRUCTING DIMINISHED PLAIN COLUMNS—DIMINISHED FLUTES—CONSTRUCTING DIMINISHED FLUTED COLUMNS—FORMING DIMINISHED FLUTED COLUMNS BY THE RIM AND COLLAR METHODS—DIMINISHED FLUTED PLASTERERS' PANELLIED COVES—PRESSED SCREEDS—DIMINISHED DOME MOULDINGS—CUPOLA MOULDINGS—PANELLIED BEAMS—TRAMMEL FOR ELLIPTICAL MOULDINGS—TEMPLATES FOR ELLIPTICAL MOULDINGS—PLASTERER'S OVAL—CAVED CEILINGS—CIRCULAR MOULDINGS ON CIRCULAR SURFACES—TRAMMEL CENTRE—FORMING NICHS BY RUNNING AND CASTING MOULDS.

DIMINISHED COLUMNS.—The diminishing of columns is an interesting but somewhat difficult operation. Great care must be exercised not to overdo the entasis or swelling. The swell may commence very gradually from the base to the capital, or the third part of the column may be of the same diameter, and then swell and diminish for the remainder of its height. Two methods are here given to show how this may be done. These are given more to illustrate the method of setting out the diminished floating rules—so necessary to the plasterer—than to define the swell or diminishing of a column, which, being within limits a matter of taste, pertains more correctly to the architect.

The best instrument for forming a diminished column—plain or fluted—is a diminished floating rule, with a cutting edge made to the contour of the proposed column. This rule is used to determine the central position of the astragal and base mouldings (which act as bearings when ruling off the floating stuff and the final coat), so as to obtain a true and uniform diminish, and also to form a fair surface. The appended illustration No. 29 elucidates the method of setting out diminished columns which is also used for setting out the diminished rule for both columns. The method for setting out a diminished rule for a column that diminishes two-thirds of its height is as follows:—The dimensions of the column having been fixed, *i.e.*, the height of the shaft and its upper and lower diameters, draw a perpendicular line which may be taken as the centre line of the column; then set out the upper and lower diameters, as shown in Fig. 12. This figure also shows one-half of the constructional brickwork, and the plaster, which is distinguished by being dark shaded, with the floating rule in position. A floating rule for forming the curved and diminished surface requires an iron plate, similar to a mould plate, as shown, so that it will cut the stuff off cleaner and truer, and last longer. The other half of the elevation shows the lines and divisions for obtaining and setting out the entasis.

To diminish the column, first divide the height into three equal parts, then at the lower third 5 draw a semicircle equal to the lower diameter of the column. Next divide the upper portion of the column into four equal parts, as shown at 1, 2, 3, and 4, then draw a line, parallel with the axis or centre line of the column, from figure 1 at the top of the column, cutting the semicircle at 1, divide the remainder of the semicircle into four equal parts, which gives the diminishing points. From these points draw lines parallel to the axis of the column, and from the corresponding figures,

as from 2 to 2, and so on. In these intersecting points fix pins or nails, and bend a flexible strip of wood or metal round the nails, and draw the curved line. The whole line from top to bottom is then transferred on to the board that is to be used for making the floating rule. This column will have its greatest diameter for one-third of its height, and the upper portion its entasis. This method is so far defective as to require the curve to be drawn by hand, a defect, however, obviated by using a column trammel, which is used for a column that diminishes with a graceful curve from the base to top of the shaft. This trammel is made as follows:—

COLUMN TRAMMEL.—A column trammel is simple in construction, and when carefully used gives very satisfactory results, forming a graceful diminished curve from the lower diameter to the upper diameter of the shaft. Before describing the method of setting out and constructing the

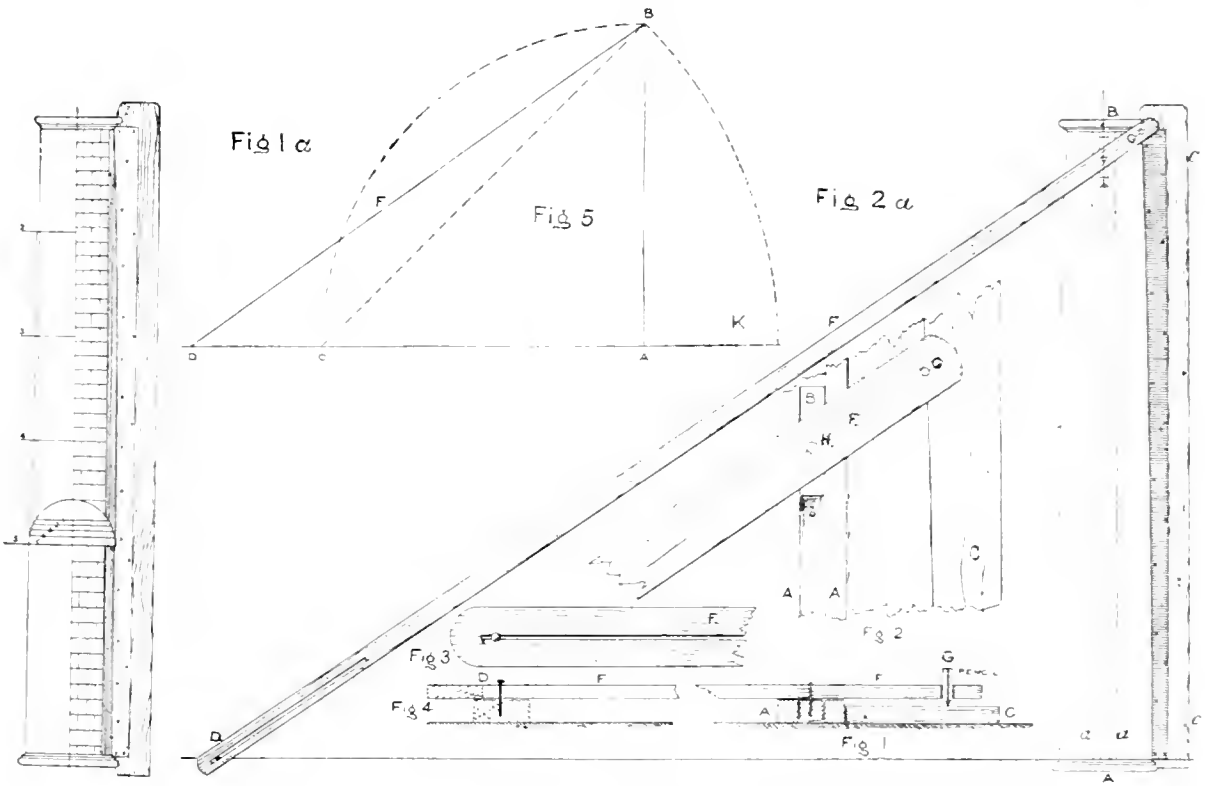

NO. 29.—DIMINISHING COLUMNS—COLUMN TRAMMEL AND DIMINISHED FLOATING RULE.

column trammel, the method of finding the point D on Fig. 2a is given on a separate sketch Fig. 5 to show the method more clearly.

Fig. 5 illustrates the method of obtaining the point D, on which the centre pin is fixed for the trammel to slide on while working. This point also gives the length of the radius-rod. This sketch is reduced one-half in size to that of Fig. 2a, but the letters correspond to it. Having set out the axis or centre line of the column AB, and the base line AC extending the latter indefinitely, as described for Fig. 1a, proceed as follows. From A as a centre, and from A to B as a radius, describe an arc, as indicated by the dotted line; then from the intersecting point at C as a centre, and from C to the point at B as a radius—as indicated by the dotted line—describe an arc until it cuts the base line at K. This done, add the distance from the point at A to the point at K to the base line, outward from the point at C, which gives the desired point D.

The trammel should be set out on a wall or a clean floor. To set it out, first draw a line to the exact height of the proposed column, as *A B* on Fig. 2*a*, then draw a line indefinitely in length at right angles to *A B*, as shown from *A* to *D*. The line *A B* is the axis or centre line of the column, and the line *A D* is the base line. To construct the trammel, take two rules, each the length of the column, and about 2 inches wide and 1½ inches thick; fix one on each side of the axis of the column, taking care to keep them equidistant and parallel to the axis, and forming a grooved space about 2 inches wide, as shown at *a, a*, the rules, and *b*, the groove. These rules are made thicker than the board intended for the floating rule, so as to allow the trammel pencil to run freely when marking the diminished line on the board. This is shown by the section at Fig. 1. This is as when done in a temporary way on a floor, but a better way is to fix the rules on a board (a flooring board will be found suitable). This makes a permanent groove, and forms an easy ground for the sliding block to work smoothly. It also allows a greater space for a thicker board for the floating rule.

Fig. 2 shows enlarged details of the groove rules *A, A*, the groove *b*, the sliding block *B*, with the pin *H*, the radius-rod *F*, with the pencil *G*, and the board for the floating rule *C*, with the diminished line. Fig. 1 shows a section of Fig. 2. The letters in all figures correspond with each other. Fig. 2*a* shows the whole column with the trammel and finished floating rule *C*. Make the radius-rod about 2 inches wide, 1 inch thick, and in length a little longer than the distance from *D* to *B*, and the half diameter of base of the shaft. The sliding block *H* is about 4 inches long, and equal in depth and width to that of the sliding groove *b*. It should be made smooth, and fit the groove easily, so that it will slide freely from end to end when working. In the exact centre of the block fix a hardwood pin or a round nail *H*. This must be fixed exactly over the axis of the column, and so fitted that it will run immediately over it from end to end. Bore a hole in the radius-rod to fit this pin, then from the centre of the pin set off exactly half the diameter of the base of the column on the radius-rod, which will give the point for the pencil hole *G*. At this point bore a hole large enough to receive a pencil, which must be tightly held in it. At the lower end of the radius-rod cut a slot just wide enough to receive the centre pin at *D*.

A plan of the radius-rod with the slot and centre pin is shown at Fig. 3, and a section at Fig. 4. The block beneath the radius-rod, in the section, is used to keep the rod level with the rules and sliding block, as shown on Fig. 1. To ascertain the length to cut the slot, place the radius-rod along the line *A D*, and the pencil at the outside of the semi-diameter at the base of the column, and slide it to its place; mark on the rod where the centre pin *H* comes; then place the pencil end of the rod at the top diameter, and mark the rod again at the centre pin; this will give the length of the pin. Having made the trammel, provide a stout board to form the floating rule *c c*. This board should be planed on both sides and one edge. Place it near the rules *a a*, keeping the planed edge outwards, and parallel with the axis or centre line of the column. This allows the planed edge of the floating rule to be used as a straight-edge to plumb by when fixing the top and bottom rims or mouldings, which are used as guides and bearings when floating the column. Place the sliding block in position, and lay the radius-rod over the centre pin and the pin of the sliding block, keeping the rod in a line with *D A*, taking care that the pencil is in its true position; then carefully move it upwards, and pressing the pencil gently upon the board, which will give the line for cutting the diminishing floating rule. The floating edge is strengthened by nailing a strip of sheet iron on the board in a similar way to that in which a mould plate on a running mould is treated. This is of special use when floating diminished fluted columns or pilasters, as the thin and sharp edge allows the flutes to be more easily formed. The diminished line on the metal plate can also be formed with the trammel.

A column trammel can also be used for setting out other diminished floating rules for columns less in size than the original one. The only alteration required for this purpose is to alter the point D to suit the size of the proposed column, and the shortening of the radius-rod. It will be seen that the floating rules for both columns are made long enough to bear on the base and necking mouldings, but it is usual to make them shorter, so as to bear on cast or run rims or collars, which are fixed at the top and bottom of the shaft.

CONSTRUCTING PLAIN DIMINISHED COLUMNS.—Plain diminished columns and pilasters are formed with a diminished rule fashioned at both ends to work on the necking and base mouldings (termed rims), or on collars. The method of making rims and collars, which are used as bearings, is as described for diminished fluted columns.

TO SET OUT THE FLUTES OF DIMINISHED COLUMN.—The annexed illustration No. 30 elucidates the method of setting out the flutes of a column. Fig. 1 shows the half plan of a column; A is the plan of the flutes at the base, and B the plan at the top of the shaft. Fig. 2 shows the elevation of the column, with the various parts marked. Fig. 3 shows the plan and centres for setting out the flutings for the different orders with arrises or with fillets. A fluted column may be divided into twenty, twenty-four, or twenty-six flutes, according to the style or order. There are two different sorts of flutes used. One is worked to an arris, and sunk down in different depths, one of which is described by the fourth part of the circle, one by the sixth, and others by the half circle, as shown at C, D, E, Fig. 3.

The square or fillet of the second kind is equal to one-third part of the flute. It will be seen in Fig. 2 that two lines are shown at the top of the flutes. The lower one shows how the flutes finish when the fourth and sixth depths are taken, and the top line when the half-circle is taken together with the fillets. Flutes that finish with an arris are usually employed for columns in the Doric order, and those that finish with fillets are used in the other orders. The fillets or lists at the top and bottom of the shaft of a column, which serve to divide the shaft from the capital and base mouldings, are commonly called the upper and lower fillets, and sometimes the horizontal fillets, but in architecture they are known as "cinctures." The curved parts at the top and bottom of the shaft which are usually curved into the upper and lower fillets by a concave curve or inverted cavetto, are in architecture termed "apophyges."

CONSTRUCTING DIMINISHED FLUTED COLUMNS.—The formation of diminished fluted columns by means of a running mould is an absorbing and vexed topic among plasterers, and many ingenious plans have been advanced for the construction of hinged and spring running moulds, and diminished running rules. I have known more than one self-improving plasterer who has expended a vast deal of time and lime not forgetting plaster to prove by actual practice the possibility of running a diminished fluted column, while others have been content to work them by theory, forgetting that an ounce of practice is worth a ton of theory. Some men thought they had accomplished a feat when they had run a single flute with a hinged mould, between two running rules fixed to form diminution in width, forgetting or not knowing that flutes diminish in depth as well as width.

The difference in depth of flutes, at the base and the top of the shaft, is shown at A, the base, and B, the top, in Fig. 1, illustration No. 30. Running moulds have also been made with springs to regulate the diminish in depth, but their action was uncertain, and they are also too expensive for the purpose. Another form of running mould was made by fixing wire, catgut, or leather on one end of one of the slippers, and on the upper edge of the stock, so that the slipper, when being forced up the diminished space between the running rules, became more angular, or in other words,

the slipper on which one end of the wire was attached was higher up the diminished space than the other slipper, and thus caused the stock to cant forward, or be drawn out of an upright, and reduce the depth of the flute. The stock in this case is connected to the slippers, not by hinges, but by a pivot inserted at each slipper to allow the stock to cant forward when pulled by the wire. This form of mould also proved to be too erratic in its working to be of useful service. Running moulds having the stock connected to a slipper at each side by means of two hinges termed a double-hinged mould allow the mould to assume an angular or slanting form as it passes up the diminished space, thus forming a diminution in the width of flute, but it does not form it with a

true arc all the way. On the contrary, it assumes an elliptical form which becomes more and more pronounced as it reaches the top of the shaft.

The nearest approach to perfection in running diminished flutes is performed by means of a running mould made with hinged slippers as described, but having the mould plate and stock cut through the centre of the profile, the two parts being then connected by a hinge. This form of running mould termed a "triple-hinged mould" allows the mould to collapse in the form of a V on plan, and the slippers to run level or parallel with each other, thus forming each half of the flute alike, and at right angles from the centre. Still this has the defect of forming the flute without the necessary decrease in depth. Various forms of hinged moulds are described and illustrated in this chapter and in Chapter X.

A method for diminishing the depth of the flutes is to make the running rules with a diminish on face, or rather to make them with an increasing thickness towards the top ends, so that the mould when running up on the increasing thickness will form a corresponding decreased depth of flute. When running a fluted column by this process, the running rules are fixed flush with the face line of the fillets. Only one flute can be run at a time, but twelve may be in hand at the same time. As there are generally twenty-four flutes

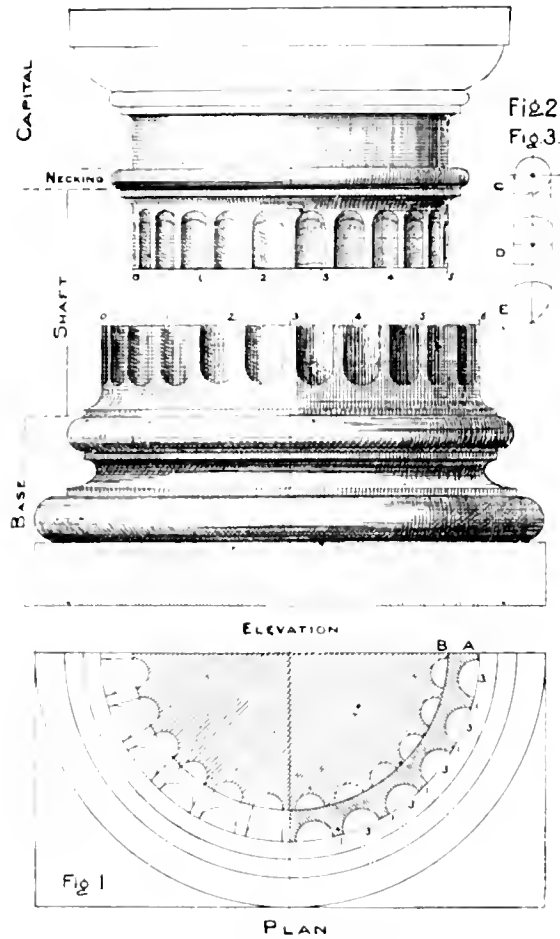

No. 30.—DIMINISHED FLUTED COLUMNS.

in a column, twelve rules would be required to keep a couple of plasterers going. When the first set of flutes are run, the rules are taken off and fixed to run the remaining flutes. When all are run, the returned ends at top and bottom require to be made good. It will be seen that the running rules for this method must be carefully made and fixed to ensure true lines and forms. It will be understood that a bed or ground must first be formed as a guide for setting out and fixing the running rules on. This is done with the aid of a diminished floating rule. It will also be self-evident that the floating rule would be more profitably employed for forming the entire shaft with the flutes, thus dispensing with running rules and

hinged moulds. This method of running the flutes is slow and tedious, but the worst part is that the flutes are not true segments; in fact, the whole of the methods mentioned are more or less a rule of thumb, uncertain and inaccurate.

A knowledge of the rudiments of geometry will prove that the true form of a diminished and swelled fluted column cannot be run with a mould, however ingeniously made. This may be proved by cutting a plaster or cardboard disc to the former radius of a single flute, and describing a line round it on a board. This would be the form the mould, when at right angles at the bottom of the shaft, would give the flute. Then place the disc in an oblique position the same as the hinged mould would be at the top, and project the plan by means of a set square on to the board. It will be seen that the mould would give the flute an elliptical form. It may be further explained by stating that when the mould is square at the base, or at right angles with the vertical running rules, the form of the flute would be a true segment; but when the mould is moved up the diminished space between the rules, it assumes an oblique or slanting position. It gives the flute an elliptical form, which increases and becomes more pronounced as it approaches the necking. It may be said that the pointed or elliptical defects can be filled in and worked fair with circular hand floats, but this plan necessitates a series of hand floats to fit the ever-varying widths and depths of the flutes.

It may seem unnecessary to describe the above methods, and then to point out their defects. However, the methods and defects are given to prevent the rising plasterer falling into the same errors, and to enable him to resist and rebut the arguments that are so often advanced by some men, who persistently assert that their own particular way (generally one of the methods already mentioned) is the correct and only way of properly performing this difficult but interesting operation.

It is worthy of note, to show the interest taken in this subject, that a patent was obtained for a running mould and process for forming diminished fluted columns, in 1878, by J. Cleghorn, a Glasgow plasterer, who obtained a provisional protection for "improvements in moulds or templates for running stucco or cement tapered fluted columns." The following is a copy of the specification *in extenso* :—

"This invention relates to the running of stucco or cement in forming fluted or other columns, pillars, or pilasters, and similar surfaces, in a more simple, economical, and expeditious manner than heretofore; and the nature and novelty of the invention as applied for running or making the body part of a fluted tapered column of stucco or cement, consisting in constructing a short box-shaped template, having two sides joined together by a back plate outside, with a handle upon it, for drawing it up and down the column, and with an open space inside the back between the sides open above and below, equal to any desired section or segment of the column at its base or widest part, into which the column is equally divided by narrow longitudinal strips of wood, against which the inner edge and end surfaces of the sides of the template slide close, so as to prevent the escape of the semi-liquid or stucco. A thin elastic segmental mould plate is hinged or jointed at its ends to the inner faces or edges of the template, formed in its inner scraping edge to correspond to the segmental curve of the base of the column, with rounded projections corresponding to the flutes to be formed on the column. This plate and its hinges are laid at an angle highest at the inner scraping edge, and inclined downwards towards the back, leaving a space between it and the back for the free passage or escape of the superfluous stucco or cement scraped off the column during the ascent of the mould along the column on its longitudinal shaping strips before mentioned.

"The one end or side of the mould is made to slide or contract laterally in slots or other

equivalent guides in the back of the mould frame as it ascends along the contracting or tapering longitudinal laths, the thin plate bending or yielding down in a curvilinear form on its end hinges before mentioned, so as to bulge inwards while bending downwards, and so contract the column in a nearly true radial and segmental form from the bottom to the top of the column, the angle at which the scraping mould plate is set on its hinges determining this contraction of the scraping centre edge of its segment radially in a ratio corresponding to the contraction of the length of the segment and moving sides of the mould, which, for large moulds and columns, might be carried and drawn up by handles secured to the tops of the ends of the moulds with ropes led up and over pulleys at the top of the column, thence down to the hand of the operators, so that the mould may be raised and lowered at pleasure to form the whole segment of the column from the bottom to the top in nearly as simple and efficient a manner as plain mouldings are at present run by the usual simple edge scraping moulds, one segment being run after the other in succession until the column is finished.

“For plain or other forms of columns the inner scraping edge of the mould plate is made to correspond to the tapered surface of the column to be formed plain, segmental, or fluted as desired; and for flat, square, or polygonal columns, which do not require a segmental mould scraper, this would be made straight, either plain or fluted, as desired, on its scraping edge, and set horizontally on its hinges, instead of at an angle as described for the segmental mould scraper for forming round columns; and this mould scraping plate in any case is preferred to be made of thin elastic steel or tempered copper or brass, which would bend and contract the flutes or ridges on the surface of the columns or pillars, equally and proportionally to the several parts of the column over which the mould is traversed. Although the mould or template has been described as made with only one of its ends movable laterally, it is to be understood that both ends or sides may be fitted so as to move in a similar manner to suit different kinds of work.”

This patent method would be better understood if it had been illustrated. No provision for diminishing the depth of the flutes is given in this method. The use of flexible metal for diminishing purposes cannot be relied on for accurate work.

Another method for forming diminished fluted columns is thus performed:—Make a single flute in plaster, and use it as a mould for casting reverse flutes composed of fibrous plaster. After casting as many reverse flutes as there are flutes in the proposed column, indurate them with litharge oil or paraffin wax. Casts of the necking and base, each with about 3 inches of the fluted shaft, are fixed on the brick core. The shaft is then laid with Portland cement (or other desired cement) and sand until within about one-third of the line of fillets, and while this stuff is still soft, take a reverse flute previously oiled, and press it into position, using the cement flutes at the necking and base as guides for fixing, and using a diminished floating rule to prove the outline. Repeat this process until all the flutes in the column are filled with reverse flutes. The intervening spaces or fillets are then filled in with gauged cement until flush with the outer surface of the reverse flutes, and further regulated with the floating rule. When the stuff is set, the reverse flutes are extracted, and any defects in the flutes made good. On the care in fixing the reverse flutes and filling in the fillets depends the success of this method.

Diminished fluted columns are also made by casting two vertical halves, and then fixing them on the brick core. The halves are fixed by means of cement dots, which are laid on the core at intervals. Corresponding dots are laid on the interior of the casts. The casts are then pressed on the core until the dots meet, and both halves are in proper position. The cast work is made solid with the core by pouring a thin and weak solution of cement and sand into an orifice at the necking.

The cement and sand should be mixed in the proportion of one of the former to five of the latter. This gauge has sufficient binding power and strength for this purpose, and is not liable to expand or contract in wet or dry weather. This process is useful for small work, and makes a good job when cleanly cast and neatly fixed. The necking with the capital and the base may be fixed before or after the shaft casts are fixed, according to circumstances. The shaft casts are best formed in a reverse casting mould, as described in Chapter XIII.

Another method of casting a diminished fluted column is effected by making a reverse casting mould. Fix it round the core, and pour the gauged material in at the top of the necking mould. By using a reverse casting mould made with a plaster face and a wood backing, or a mould made in fibrous plaster, the whole column with the core can be made in one piece. Hollow columns, composed of Portland cement concrete, can be made to carry any weight supported by a stone column, or one constructed with a brick core of equal diameter. Cast hollow columns are made by temporarily fixing a wood or fibrous plaster core tapered to one end to allow it to be withdrawn when the concrete is set. A rough wooden or a fibrous plaster hollow core is used when casting a hollow column *in situ*. The core in this case is left in.

After many years' experience and observation on this subject, I am of opinion that the true form of a diminished fluted column (composed in Portland or similar cement, and constructed *in situ*) is best obtained by hand, with the aid of cement rims or plaster collars and a diminished floating rule. Most plasterers will admit that what can be and is done in stone or wood, can be done equally well in cement or plaster. A plasterer has one advantage, inasmuch as he can add as well as subtract when forming circular surfaces, whereas the mason can only subtract. The two methods hereafter given for forming diminished fluted columns by hand are simple, speedy, and accurate. They are on one principle, and each may be used as circumstances require: one is termed the "rim method," and the other the "collar method."

FORMING DIMINISHED FLUTED COLUMN BY THE RIM METHOD.—First make models of the half circumferences of the astragal or necking and base mouldings, each having about 4 inches of the fluted shaft, as shown at Fig. 1, the plan, and Fig. 2, the elevation, on illustration No. 30. To make the models, cut a mould plate to fit each of the full-sized mouldings, and the required size of the shaft, and "horse" them with radius-rods, and run a little over one-half of each circumference in plaster, and then cut them to the exact half circumference. This done, set out the flutes, then cut them out and form the returned ends. The method of setting out the flutes on the ends of the models is shown on the plan at Fig. 1. A is the plan at the base, and B the plan at the top of the shaft. The returned ends of flutes are shown on the elevation, Fig. 2. Add the square plinth to the base, as shown on the plan at Fig. 1, which completes the models. Piece mould the models in plaster, and then cast as many half astragal and bases as required. The materials used for the casts must be the same kind as intended for the shaft. The brick or core of the column is now cleaned and well wetted, and then the astragal and bases are fixed in position, using the diminished floating rule to prove if they are central, and the fillets linal with each other. Apply a plumb rule on the back edge of the floating rule to test if the astragal and base are concentric and parallel with each other. When these half casts are fixed together on the shaft they are termed "rims." The intermediate space on the shaft is then filled in and ruled off with the diminished floating rule, using the rims as bearings and guides for forming the fillet line of shaft.

The method of forming a diminished fluted column by the "rim method" is further elucidated by the annexed illustration, No. 31. This shows an elevation of the brick core of a shaft with the astragal rim, A, and the base rim, B, fixed in position. D is the diminished floating rule in position

for floating the main or fillet line of the shaft. The method of using a diminished flute rule for the flutes is illustrated in the "collar method."

A second diminished floating rule is required to form the back surface of the flutes. This can be quickly made by laying the first rule flat on the floor, and from this, with compasses, describe the back line of the flute on another board, which is afterwards cut to the desired line. This rule is used as a long joint rule to form the flutes. The rule should be worked with uniform pressure, the man at the top working in unison with the man at the bottom, both working the rule with a circular cutting motion. The flutes are fined down by the aid of a small float semicircular in section. For extra large columns three floats should be used—No. 1 cut to the top section, No. 2 cut

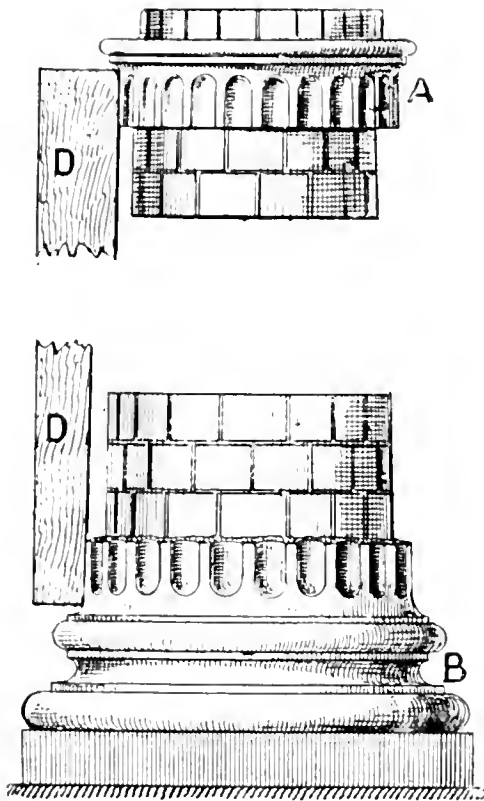

NO. 31.—FLOATED FLUTED COLUMNS—
RIM METHOD.

to the middle section, and No. 3 cut to the bottom section. The length of the floats may vary from 5 inches to 7 inches, according to the height of the column. If the columns are required with a smooth surface, the flutes are worked as above, but the floats are covered with fine felt, leather, or rubber, and the surface finished smooth with short joint rules or with pieces of flexible busks. The cast parts of the shaft, to the fillet members of the astragal and the base, should be keyed with a drag, so that the whole shaft, from arris to arris of the astragal and base fillets, can be fined, thus giving a uniform texture and colour, and avoiding a surface joint of the cast work and the fined work.

A modification of this method is as follows:—The lower horizontal fillet of the shaft and the base mouldings are cast separately, the fillet part being used as bearings for floating the shaft, as already described, and the base is fixed after the shaft is fined. This plan is useful for some purposes, such as for extra large columns, as it gives more freedom for working the shafts, and the bases are not so liable to get injured while working over them.

RUNNING DIMINISHED FLUTED COLUMN BY THE COLLAR METHOD.—Run a plaster collar about $1\frac{1}{2}$ inches wide to the diameter of the top horizontal fillet of the shaft. The thickness must be regulated accord-

ing to the space between the brick core and the line of fillet. Cut this collar in halves and fix them on the brick core, keeping the under side in a line and level with the top of the proposed fillet of the shaft. Run another collar to fit the horizontal fillet at the base of the shaft, and fix the upper side of this one level with the bottom edge of the fillet at base of the shaft. This done, make two plaster models of the flutes, one for the top and one for the bottom of the shaft, each about 3 inches wide, and in thickness according to the brick core, the diameter being taken about 1 inch above the returned ends of the flutes at the top and bottom of the shaft. These models are set out and made as described for the first method, but using plaster instead of cement for the casts. The plaster casts are fixed in position, and then the brick core is laid and ruled off, using the main diminished floating rule and the plain collars as bearings for forming

the main contour or line of the vertical fillets, including the horizontal or top and bottom fillets of the shaft, and using the diminished flute floating rule (and the plaster models of the flutes as bearings) for forming the flutes. This done, the fluted collars are cut out, the spaces filled in and ruled off, and the returned ends of the flutes are formed, and then the whole shaft is fined while the work is green. The fillet collars are then cut out, and the astragal and base mouldings are then fixed, thus completing the column. It will be seen that this method entirely dispenses with joints between cast and floated work on the shaft, and allows it to be fined in one operation.

The method of running diminished fluted columns with the aid of collars is further elucidated by the annexed illustration No. 32. AC is the top fillet collar, BC the bottom fillet collar, and FC and FC are the top and bottom flute collars fixed on the brick core of the column. DR is the main diminished floating rule in position for forming the main contour or fillet line of the column. This rule is rebated at the top to allow for a bearing on the top as well as on the edge of the collar. This rule also forms the profile of the top and bottom horizontal fillets, and the curved parts of the shafts below the top fillet and above the bottom fillet. FR is the flute floating rule in position when forming the flutes. The ends of this rule as shown bear on the back surface of a flute as indicated by the dotted lines. A portion of the astragal moulding, A, with a part of the shaft, is shown so as to indicate the position to fix the fillet collar, AC; a portion of the base moulding, B, with a part of the shaft, is also given to show the position of the bottom fillet collar, BC. It will be seen that these collars form a fair bed for the astragal and base mouldings, and when taken off they leave true joints as indicated by the arrows at A and B.

A modification of the above methods for forming the fillets and flutes is effected as follows:—Fill in the spaces on the shaft between the collars in this method—or the rims in the former method—and rule them off with a main diminished floating rule as already described; and when the stuff is firm but not set, the positions and forms of the fillets and flutes are set out on the floated surface, then the flutes are cut out by hand by means of gouges and drags, and afterwards fined as already described. This system is specially useful for small columns.

For extra high columns it will be found difficult to work a floating rule to form the whole height of the column in one operation; in fact, for some columns to be seen in London, which are 20 feet to 30 feet high, and even higher, it would be impossible to form them with one floating rule. It is therefore necessary to divide the column into two or more sections, and cut the floating rules accordingly. In this case two or more plaster collars about 3 inches wide, and made to the exact circumference of the column at the point of division, are required. These collars are then temporarily fixed in position to act as screeds, and after the whole surface of the column is filled in and ruled off, the collars are cut out and the spaces filled in, and then the whole surface fined in one

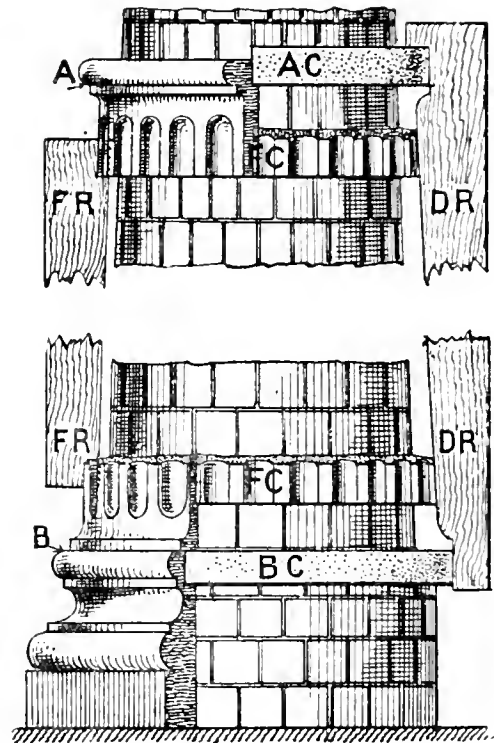

No. 32.—FORMING FLUTED COLUMNS—
COLLAR METHOD.

operation. Three or even more floats, as already described, are required for the fining of high or massive columns.

Having now briefly reviewed the more or less useful methods, and described some of the most useful and practical methods, the conclusion to be drawn is, that diminished fluted columns are best done by working them by hand, with the aid of diminished floating rules and cast or run bearings. The first or rim method will be found useful for many purposes; but the collar method, with the addition of intermediate collars for extra high columns, is the best for general use.

DIMINISHED FLUTED PILASTERS.—Pilasters are said to be a Roman invention. They bear an analogy to columns in their parts, have the same names and standard of measurements, and are diminished and fluted on the same principles. When pilasters are placed behind columns, and very near them, they should not project above one-eighth of their diameter; but if they are from 6 to 10 feet behind the column, as in large porticos and peristyles, they should project at least one-sixth of their diameter. When they are in a line with columns, their projection should be regulated by that of the columns. When pilasters are used alone as principals in composition, they should be made to project one-fourth of their diameter to give regularity to the returned parts of the capitals. The process for forming pilasters is the same as for columns.

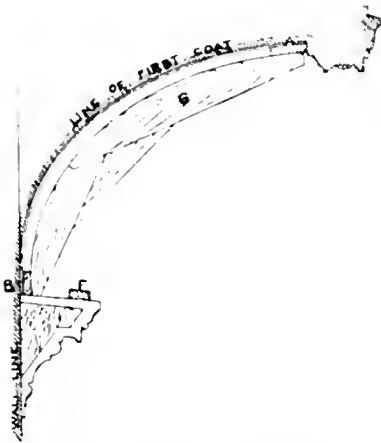

NO. 33.—SECTION OF COVE SHOWING PRESSED SCREED PROCESS.

PANELLED COVES.—Large coves, segmental or elliptical on section, having their surfaces panelled with mouldings which spring from the back or above a wall or main cornice, and finish at or intersect with a beam or other moulding at the top or crown of the cove, require to be carefully set out and screeded. The floating is done from two horizontal screeds made at the top and bottom of the cove, and from these vertical screeds are formed, and then the intermediate spaces or bays are filled in and ruled off with a floating rule bearing on the vertical screeds. The horizontal screeds are easily made, but the vertical ones require special care to ensure all being uniform in section. These screeds are formed with a template cut to the desired section, and about 2 inches thick. For large coves they are made with three or more pieces of wood. The most correct and expeditious way of forming circular screeds is by the "pressed screed" process.

Pressed screeds are simple and expeditious in construction. They form accurate grounds for floating purposes and for running mouldings on circular surfaces. The method of forming pressed screeds and floating coves is shown in the accompanying illustration (No. 33). This shows the section of a cove with the main or wall cornice and the crown moulding. F is a nib rule used when running the main cornice. To float this cove for the running of vertical mouldings, first form the top and bottom horizontal screeds A and B, then form the pressed screed. This is effected by temporarily fixing the template, G, or by one man holding it on the bottom screed, and another man holding it on the top screed, while a third spreads and presses the gauged coarse stuff until the space between the first coating and edge of the template is filled up, then drawing the trowel down each side of the template clears off any superfluous stuff. The template, which has been previously oiled, is then removed, leaving a narrow but true and smooth screed ready for working on. This method gives a truer screed, especially in elliptical or long circular screeds, than floating

or working with a template, because if the template is not worked perfectly vertical, the curve of the screed is altered and not true.

The subjoined illustration No. 34 elucidates the method of forming the screeds for floating cove surfaces, also for floating segmental, elliptical, or any other form of interior and exterior angles in coves. Fig. 1 shows a plan of the cove. The letters in this sketch correspond with those on the same parts in the section on illustration No. 33. The first coating and the various bays, after the screeds are made, are indicated by crossed diagonal lines at the D's. The top screed, A, should be levelled from end to end and made parallel in depth with the crown moulding. Their levelness is tested with the aid of a "levelling" rule. The bottom screed, B, should be made parallel with the main cornice, so that the projection of the vertical mouldings will be uniform. The vertical screeds, C, are next formed, making the first two near the internal angles, then two at the external angles. The intervening space is now set out, so that the screeds may be 8 or 10 feet apart. The screeds may be formed farther apart according to requirements. If there are vertical mouldings to be run in the cove, the screeds should be made at the sides of the proposed mouldings. It is always best to have two or three screeds near the angles, so as to give a bearing for the floating rule, K. This shows the position of the rule when floating the internal angle. The external angles on the other side are formed in the same way. The distance between the screeds

used for floating the angles can be regulated according to the depth or form of the angle. It will be understood that the floating rule must be sufficiently long to bear on two vertical screeds, and reach to the extreme point of the angle. The floating rule, K, here shown, is termed a grooved floating rule. This is grooved on both sides, as shown by the section, S. This grooved floating rule is described in Chapter XXI.

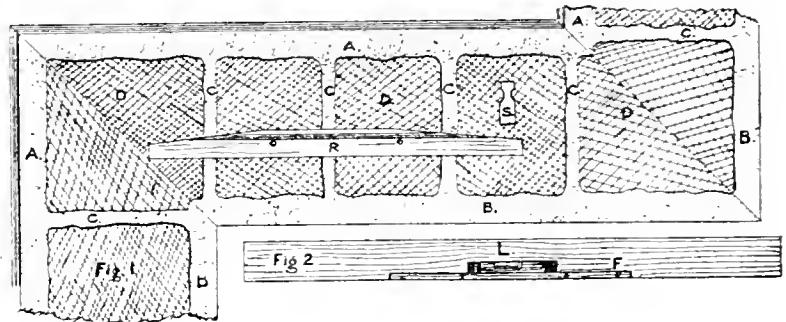

NO. 34.—FIG. 1, FLOATING COVES. FIG. 2, LEVELLING RULE.

Fig. 2 shows the elevation of a levelling rule as used for levelling dots for ceiling, beam, or crown screeds. This is similar to an ordinary parallel rule, but with the addition of a fillet, F, nailed flush with the bottom edge to form a ledge to carry the spirit level, L. The levelling rule is applied on the dots to test if they are level; this is proved by inspecting the spirit-level; if one dot is too full it must be depressed until the levelling rule is level.

DIMINISHED MOULDINGS.—Mouldings that diminish in depth or projection as well as in width (termed "double diminished mouldings", are not so common as those that diminish in width only. The diminish in width is simple, and is obtained by the aid of a "triple-slipped" running mould and two running rules fixed to form a diminished space, as described hereafter. The formation of a regular and pleasing diminish in depth greatly depends on the profile of the moulding. A moulding having small members, especially at the sides, is more difficult to diminish than one having large members, especially one with plain and deep fillets at the sides. Three methods are here given for running double diminished mouldings on domes, cupolas, or vaulted ceilings, or on lower surfaces. These methods give good results, especially if a little thought for the requirements of the case is bestowed on the designing of the moulding.

DOUBLE DIMINISHED MOULDINGS—FALSE SCREED METHOD.—By this method the diminish in depth is obtained by false screeds, and the diminish in width by the aid of a diminished rule, which is fixed on the centre of the profile or bed of enrichment. This method is elucidated in the following illustrations. The annexed illustration No. 35 shows the section of a vertical moulding on the plaster or floated surface of the inside of a dome. C is the main cornice from which the inner line of the dome springs. The D's are dots which are used to regulate the diminish of the false screeds. The various thicknesses and positions of the dots are obtained by setting out the full size of the section on a floor or worked out to a scale. If the section is elliptical, dots should be placed at the points where the transition of curves takes place. When the surface of the dome has been floated, the diminishing dots, D, are placed at each side of the intended moulding and at their proper positions, beginning above the main cornice, C, and going upwards in rotation but having no dot at the top. The spaces between the dots are next filled and ruled in, bearing on the various dots with the curved rules or templates. When ruling the top bay of the screed,

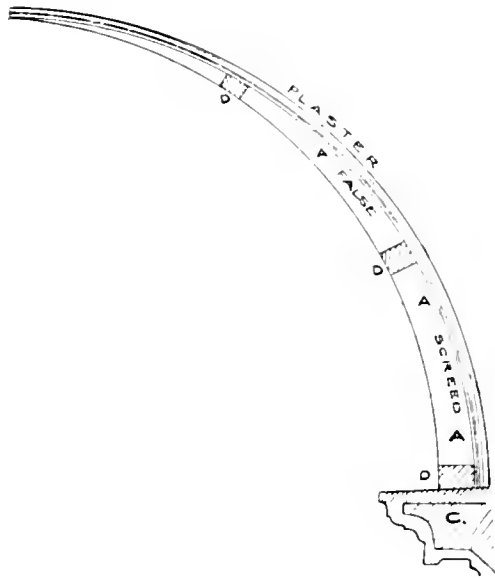

No. 35. SECTION DOUBLE DIMINISHED MOULDINGS—FALSE SCREED METHOD.

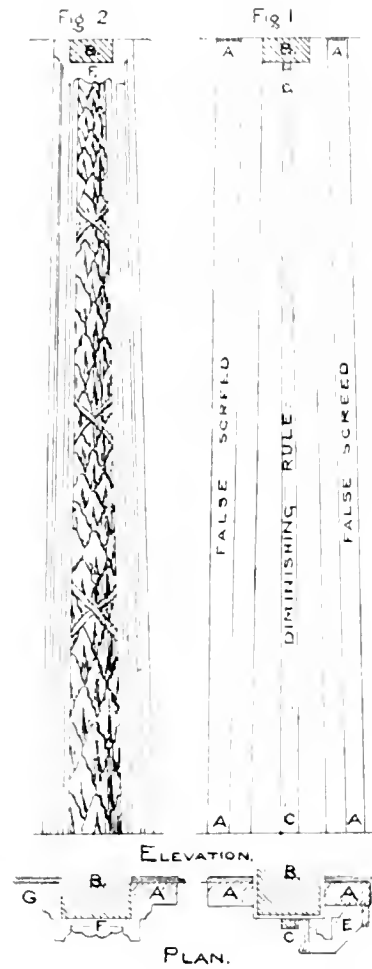

No. 36. —ELEVATION DOUBLE DIMINISHED MOULDINGS—FALSE SCREED METHOD.

the top end of the rule bears on the original floating at the top or extreme point, this point being the true thickness of the screed.

Illustration No. 36 shows the plan and elevation of the work. Fig. 1 shows it in progress, and Fig. 2 when finished. The A's on plan and elevation Fig. 1 are false screeds, the B's are brackets, while C C indicates the diminished running rule. This rule is made as follows:—First plane one face of a pine board about 1/2 inch thick, and of sufficient length and width for the desired purpose. On this make a centre line from end to end. From this centre line set off the width at

one end, and the diminished width at the other end; then extend the diminished width lines from end to end, and then plane the running edges to the diminished lines. In order to allow the rule to bend freely to the curved surface, make a series of saw-cuts crossways on the back or bed face. The false screeds are made as already described. A centre screed for the running rule is made by the aid of a template. This is made with two slippers, one on each side, similar to a running mould, so as to run on the false screeds, the centre or cutting edge of the template being made to the depth of the proposed screed. The face surface of the bracket is then laid with gauged stuff, and finished off by working the template up and down. This done, fix the diminished rule, C, on the centre of the screed. The running mould, E, on the plan is made with the slippers, one to bear on the centre screed and against the running rule, and the other to bear on the side false screed. The slippers are made circular on their running edges, so as to fit the circular screeds. A short slipper at the nib gives more freedom and ease when running the moulding, and the mould is not so liable to cut up the screeds. After the moulding is run on both sides, take the running rule off, then cut the false screeds down to the floating, and make the sides of the fillet good, and then fix the enrichment. Fig. 2 shows the plan and elevation of the finished moulding and enrichment. A, on the plan, shows one side of the moulding before the false screed is cut off, and G shows the screed cut off and the member made good to the floating. The amount of diminish from the bottom to the top of the moulding is shown at the brackets B and B, and by the profiles of the cornice on the plan and elevation. The bed and section of the enrichment is shown at F on plan. As this enrichment is diminished in width and projection, the whole length must be modelled.

RUNNING DOUBLE DIMINISHED MOULDINGS,—DIMINISHED RULE METHOD.—This is a method which I have introduced, and is somewhat similar to the first method described. It is well adapted for running mouldings, having no enrichment on the centre of the section, the bed of which may be used as a screed and bed for a running rule, as used for the first method. By this method the whole moulding is run in one operation. The diminish in depth is obtained by the use of two running rules diminished on the face, or in other words, diminished in thickness. The diminish in the thickness of the rules is obtained by setting out the full size, as described for the false screeds in the first method. A series of saw-cuts must be made on the backs of the rules to allow them to bend to the circular surface of the dome. These rules act in a similar way to the false screed used in the first method, with the addition that they form the fillets of the outside members, thus avoiding cutting the screeds down and making good the fillets. They are also used for obtaining the diminish in width. This is effected by first making a central line on the bed surface of the proposed moulding; then from this line, at each side, set out the half width of the moulding, including the bearing parts of the running mould. This is done at the widest or bottom end of the moulding, and at the narrowest or top end. Then from these width marks, lines are extended from end to end. On these lines, nails are inserted from 2 to 3 feet apart, which act as guides for fixing the running rules. The inner sides of the rules are placed against the outer sides of the nails and fixed, and then the guide nails are extracted, thus forming the diminished space and bearings. A triple-hinged mould with a slipper at each side is used, so that it will close up while being run up the diminished space. The stock is rebated, so that it will run on the tops and inner sides of the rules. The mould plate must be cut to fit the section at the greatest width of the moulding, but care must be taken that the depth at the outer members is the same as proposed for the top. The ends of the inner slippers and the adjoining parts of the stock are cut so as to leave an open space, to allow both parts to work freely when the mould assumes a raking position, as shown on illustration No. 37.

The extra depth of the square of the outside members is formed by the running rules. It

may here be remarked that the thickness of the rules at the top should be made about $\frac{1}{2}$ inch thicker than the depth of the square part of the outside members. For example, if the depth of the fillets or square part of the outside members is 1 inch, the rules should be $1\frac{1}{2}$ inches thick at the top. This allows for the requisite bearing for the running mould. The ends of the stock that bear on the inside of the rules must be rounded off to allow the mould to run freely when it closes up while being run up between the diminished space.

The various parts of the running mould are shown in the annexed illustration (No. 37). Fig. 1 shows the mould in position at the bottom or widest part of the moulding; R, R, are sections of the running rules; S, S, the slippers; and H, H, the hinges which connect the two halves of the stock to the

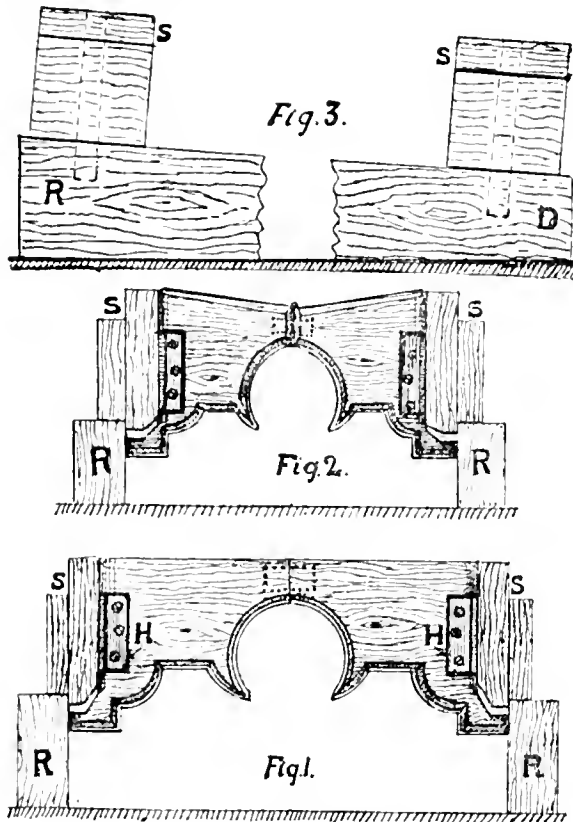

NO. 37.—ELEVATIONS AND SECTION OF RUNNING MOULD AND RULES FOR DOUBLE DIMINISHED MOULDINGS—DIMINISHED RULE METHOD.

purpose. The diminish in width is obtained by fixing two slipper running rules to the desired diminish and a triple-hinged mould as previously described, and as shown at Figs. 1 and 2 on the annexed illustration, No. 38. Fig. 1 shows the running mould, M, and the slipper rules, R, R, at the full-sized or springing end of the moulding, and Fig. 2 shows the running mould and rules at the diminished end. The diminishing depth is obtained by the aid of a "top rule," which is fixed on two blocks, one at each end of the moulding, as shown at Fig. 3. This shows the elevation of one side of the running moulds at the springing and diminished ends of the moulding, also the running rules. B is the section of the fixing block at the springing end of the moulding, and D is the fixing

slippers. The hinge which connects the mould in the centre is fixed on the other side of the stock. Its position is indicated by dotted lines. Fig. 2 shows the form of the mould when at the top of the moulding. The letters correspond with those on Fig. 1. The thin seams at the centre and sides of the moulding which are caused by the joint of the mould in the centre and by the joint of the mould and the rules are cleaned off by hand. This method, like the first, has the defect that the actual diminish or the whole depth of diminish lies in the fillets of the outside members of the moulding. The difference between the diminished members and the regular members will be most noticeable on the adjoining members, the vertical fillets of the cavettos. If this defect should prove offensive to the eye, it may to some extent be remedied by working these members down by hand, with the aid of planes, gouges, drags, and joint rules, after the moulding is run, so as to reduce the depth of the fillets, and throw the difference into the cavettos. A line should be set out to the desired diminish on the fillets to act as guides when working the cavettos down.

RUNNING DOUBLE DIMINISHED MOULDINGS—TOP RULE METHOD.—Running double diminished mouldings by the aid of a "top rule" is another method that I have introduced for this

block at the diminished end, upon which the top rule, T, is fixed. This rule is fixed on the slant, to suit the desired diminish. It must be made sufficiently wide to allow a bearing for a part of each half of the stock, M M, of the running mould, and also fixed over the joints of the mould, as shown at T, Figs. 1, 2, and 3. The top rule being fixed on the slant, causes the running mould to gradually cant over when it is drawn from its upright position at the springing end of the moulding to the diminished end, as shown at Fig. 3, thus forming the diminish in the depth of the moulding. M a shows the end section of the stock in an upright position when at the springing end, and M is the section of the stock in a slanting position when at the diminished end of the moulding. The dotted lines in both indicate the parts of the stocks inside the slippers, and the angular dotted line at H, H, indicates the splayed or cut side of the hinge. S S is the outer elevation of one slipper when at each end of the moulding, and R is the slipper running rule.

It will be seen that the running mould at Fig. 1 is somewhat similar to the triple-hinged running moulds previously described. But there are two important exceptions, namely, the hinges at the centre and the two sides of the mould.

The side hinges for this mould must be cut on one side and the angles rounded off, leaving only one screw-hole, so as to cause less friction, and allow this part of the hinge to turn on a screw when fixed on the slipper. The use of this will be seen hereafter. An elevation of a hinge, before and after it is cut, is shown at Fig. 4. The lower hole on the cut half of the hinge is used, because the nearer the "turning points" or pivots are to the running ground or screed, as the case may be, the less will the bearing edges of the running mould rise when the mould cants over. For instance, if the "turning points" were made at the centre of the depth of the mould, the bearing edge of the mould would rise from the ground in proportion to the cant of the stock. This would increase the depth of the lower members (those below the pivots or turning points), instead of diminishing them. This hole must be enlarged so as to admit of a short thick screw to give the necessary strength. It will be understood that this part of the hinge works on the plain part at the head of the screw.

Having cut the right and left hinges, they are screwed on to the stock and the slippers of the running mould, keeping the half of the hinge with the three screw-holes on the stock, and the cut part with one screw-hole on the slippers, as shown at H, H, Fig. 1. It will also be noticed that these hinges are fixed at the lower edge of the mould. This is done so as to allow the stock of the mould to cant from its base for the reason already mentioned. When screwing the cut side of the plate to the slipper, allow just sufficient play for the hinge to turn smoothly but firmly on the screw. The centre hinge connecting the halves of the stock, M M, is formed with two pieces of metal plate. The inner ends are rounded off to allow them to turn, and a circular orifice one-third the width of the

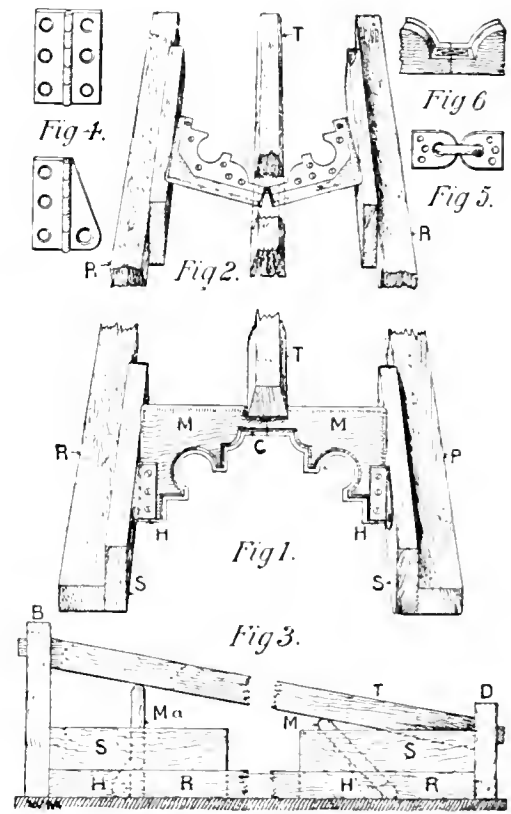

NO. 38.—ELEVATIONS, PLAN, AND SECTIONS OF RUNNING MOULD AND RULES FOR DIMINISHED Mouldings—TOP RULE METHOD.

plate is drilled at the circular ends, and then three or more screw-holes for fixing purposes are drilled on the other ends. The two plates are fastened together with a flat metal ring or with stout copper wire. The thickness of this ring is regulated according to the size of the orifice, but allowing just sufficient play for the plates to turn both ways when the mould assumes a slanting and an angular position, as shown at Fig. 2. An enlarged view of the centre hinge is shown at Fig. 5. The centre hinge is screwed on the inner side or profile of the stock, as shown at c, Fig. 1. An enlarged view of part of the stock at the joint, when inverted for fixing the centre hinge, is shown at Fig. 6. The top and bottom edges and the ends of the stock must be rounded off, to allow it to cant over more easily. The diminish of this moulding, both in depth and width, as shown in the illustration, is a little more than may generally occur in practice, but this is given to show the various parts more clearly, also what to avoid in the amount of diminish when using this method.

The diminishing depth here shown is about two-fifths, and the diminishing width about one-third. The diminishing depth, by this method, should not be overdone, because the running mould assumes an angular position both on plan and section, therefore it forms the vertical parts of the members in a slanting line and the horizontal parts out of a level. These defects become more pronounced at the diminished end of the moulding, as shown at Fig. 2. The top member can easily be made level and fair by hand, but it would entail too much labour to rectify the defects of the other members, therefore this method should only be used for small mouldings or where the diminish in depth is of a slight nature. The seam at the top member, caused by the joint of the mould, is cleaned off and made good by hand.

Fine examples of diminished mouldings are to be seen in the new dome of the National Gallery. The mouldings are diminished in width only, but the centre enrichment is diminished in width and depth. This enrichment was modelled in sections to make up the whole length of the moulding. The various sections were then moulded, cast, and fixed separately. There are other fine examples of ornamental plaster work in the various new galleries, mostly different designs, which were built at the same time (about twenty-five years ago) as the above-mentioned dome. The late Sir Charles Barry was the architect. The plaster work was done by Messrs H. & H. White, the modelling by J. Naimby and the author. R. Maskell was the shop foreman, T. White and W. Tipping were the scaffold plasterers, and S. Otley was the general foreman plasterer. Parian cement was used for the principal portion of the work, and superfine Keen's cement was used for the Corinthian capitals on the marble columns.

CUPOLA PANELS AND MOULDINGS.—In order to facilitate the setting out and formation of cupola panels and mouldings, the method of drawing them is given. This will be found very useful in the general setting out and construction of cupolas, whether in "solid" or in "fibrous plaster." Various parts of cupolas and soffits of arches (from designs by J. Gibbs, architect, a pupil of Wren, and a great patron of the plasterer's art), with the method of drawing same, are illustrated on Plate XXXIX. To draw an octagonal cupola, as shown by the plan at Fig. 1, take A B (the width of one side of the octagon) as the base line. From the centre of this erect the perpendicular line D C, then draw the lines C A and C B; this will give the triangle A B C, forming the plan of an eighth part of the cupola. The profile (Fig. 2) is made by the quadrant of circle (A B C) directly over the plan. Divide half the base line, A B on plan, into seven parts, as here figured, and six of them will make two panels; the seventh will remain for the border. The same divisions must be marked on the profile over the line A B, as follows:—Take for the border at the bottom four parts, as shown in the plan; place them on the profile from the base line to No. 1, and draw a line parallel to the base line of the plan; measure the length of the two central lines marked 2 2, and place it in the profile

Fig. 4.

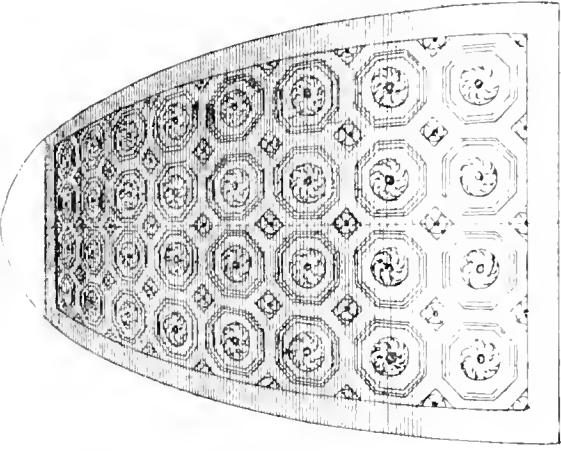

Fig. 3.

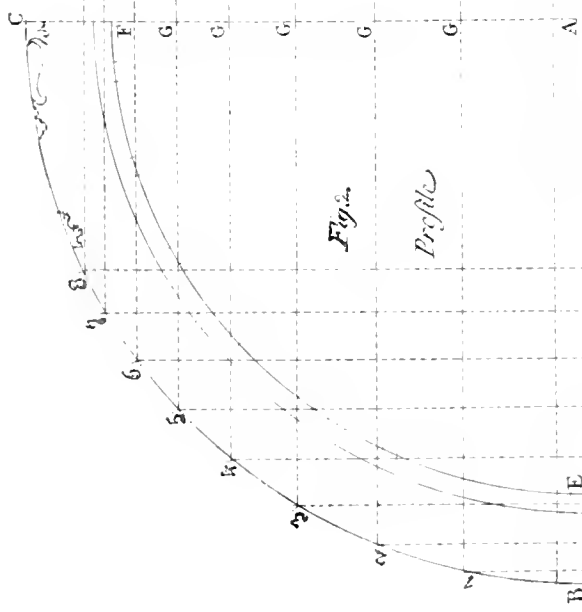
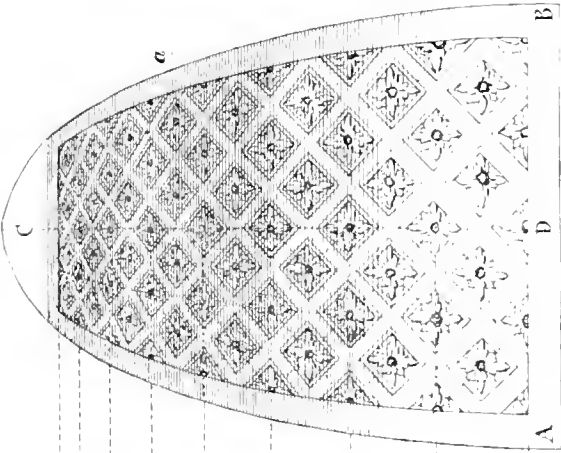
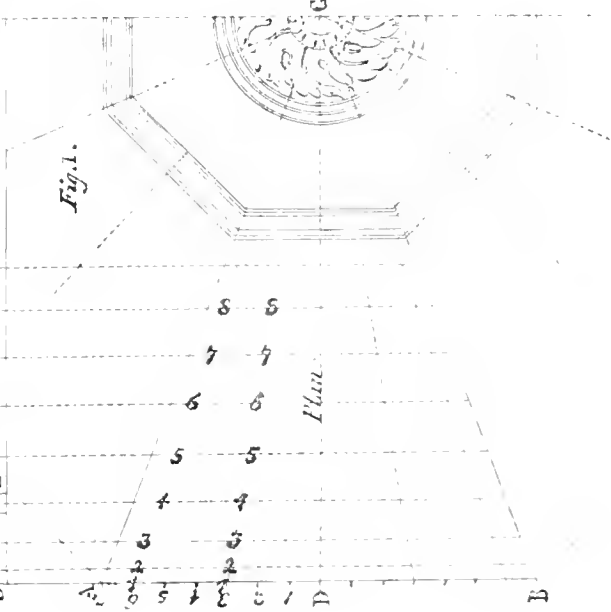

Fig. 2.
Profile

Fig. 1.



Plan

The Upright of the Side of the Cupola

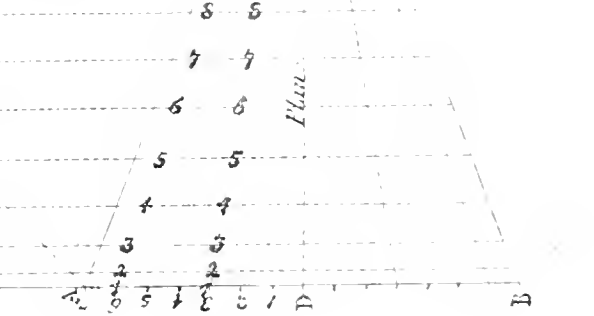
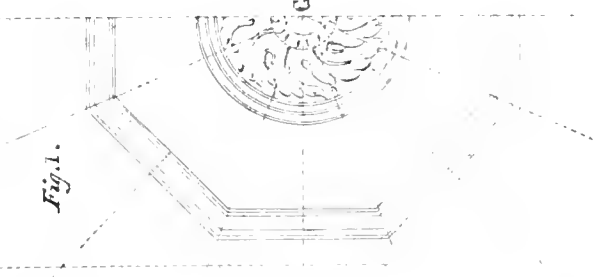
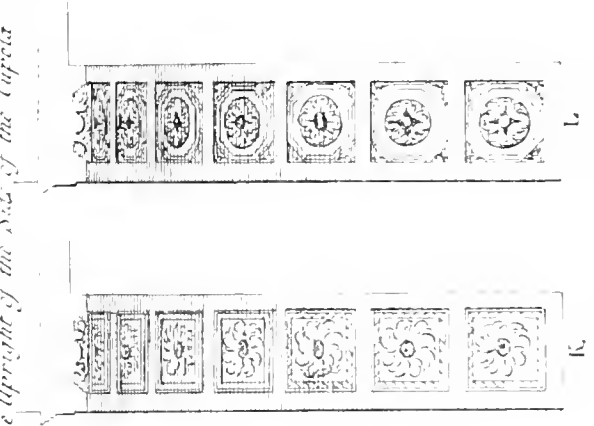
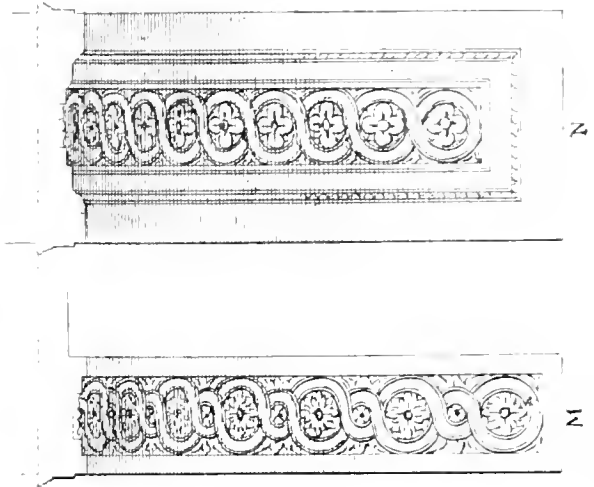

SETTING OFF AND PLASTERING CURVA PARTS AND MOLDINGS AND SCROLLS OF ARCHES.

for the second panel. From thence draw another parallel line, and measure the length of the two central lines at 3 3 in the plan to find the square height of the third panel, and so on to No. 8, as shown in the plan and profile.

The elevation or upright side of this octagonal cupola (Fig. 3) is made by the following geometrical rule. First draw the base line *A B* on plan even with the base line *A B* of the profile; on this erect the perpendicular line *D C* for the centre of the side; then draw all the parallel lines as shown by *G, G, &c.* Take half the length of each line, figured in the plan, and mark it on each side of the middle line of Fig. 3 until the length of every panel is fixed. From these lines and points the forms or outlines of the panels are taken. The inner divisions are brought over to the number of panels contained therein in the same manner as they appear in Fig. 3. The same rule is used for setting the side shown at Fig. 4.

With regard to the soffits of arches, if they are divided into panels, they must be of any uneven number, as shown at *K* and *L*, by having a panel in the centre. The border must not be more than one-sixth nor less than one-seventh part of the whole breadth. The quadrant or profile, *E F* (Fig. 2), on which the panels of this semicircular soffit are divided, will be sufficient to explain them. A circular soffit of lesser breadth is shown at *M*, and one of greater breadth is shown at *N*. Sections of each soffit are shown at the top of the elevations.

The method of constructing the plaster work of cupolas depends to some extent on the design and size of the panels and mouldings. For example, if the diagonal panels shown in Fig. 3 were sufficiently large to admit of a running mould to run a piece of moulding (on each side of the panels) not less in length than the mitres at each end, the best method would be to run the four sides of all the panels; but if the panels were too small to allow a running mould to run the requisite amount of moulding, it would be necessary to run a part, and cast, or run down, and plant the other parts. In some designs it would be necessary to plant all the mouldings. In some cases the panel mouldings, from the base up to a third or fourth of the height of the cupola, can be conveniently run; but the panels above this which become smaller, and are too small to admit of their being run with economy, should be planted. Another method is to run all the diagonal mouldings that spring from left to right, as from *A* to *a*, in one length from border to border, and then run the intermediate parts of the mouldings springing from right to left.

The intermediate parts may also be run down, or cast, and then planted. By this method the intermediate parts only require mitring, and if they are planted the intersections only require to be stopped. If these parts are run, the brackets from right to left must be cut down at the intersections to allow the running mould to pass when running the mouldings from left to right in one length. Whichever method is employed, the surface must be floated true to the various curves to form a ground for the mouldings, whether run or planted. The surface should also be floated sufficiently smooth to act as screeds without using gauged putty screeds for each moulding. This is done as described for panelled ceilings. The groundwork of the floating is effected by first forming a screed on the base border *A B*, and one on the top border at *C*, and then from these screeds as bearings, form two screeds on the side or vertical borders, thus completing the main screeds, and from which the panel surface is floated. Owing to the brackets and the form of the panels, it is a somewhat difficult operation to float all the panel surfaces with a uniform depth and curve. It will be seen that a floating rule cut or so constructed to clear the brackets, whether worked vertically or horizontally, cannot travel into the angles, and float the whole surface. This difficulty is overcome by making dots in each angle, or making narrow screeds from angle to angle of each panel. The horizontal dots or screeds as the case may be, are ruled off with a gauge rule,

which is cut to the required depth, and to bear on the side screeds. The vertical screeds are ruled off with the circular rule, on which pieces of board cut to the desired depth and length of the various panels have been previously fixed. The intervening spaces are then ruled off with short rules cut to the angular curves.

Another and better way is to cut an angular floating rule to fit the curve from *A* to *a*, and float all the panel surfaces in a line from border to border in one operation. This angular rule is set out in a similar way as described for angle brackets. The rules for this or the first method must be made to suit the longest line or set of panels. After each set of corresponding panels in the other sides of the cupola is floated, they must be shortened to fit the next set of panels, and so on, until all the panels are floated. The mouldings being diminished in width, are run from a diminished running rule fixed on a centre screed in the same way as described for diminished dome mouldings. The screed for this method is formed by an angular floating rule cut to the angular curve, as already mentioned. For some designs the moulding may be run with a twin-slipped running mould. This form of mould can also be used for forming about 1 inch of the panel surface. This acts as a ground for floating the panel surfaces. When large paterae are used, the ground panel surface may be cast with them, thus avoiding floating and setting. The octagonal panels shown in Fig. 4 are formed in a similar way to Fig. 1. After the vertical and horizontal mouldings are run, the diagonal sides of the octagons are planted. Where square panels form the design, the mouldings can be run with a radius-rod running mould from a centre pin and block. The section of the soffits of the arches are run with a radius-rod running mould, fixed on a radius board, and the cross styles or mouldings, as shown at *K* and *L*, are planted. A small portion of the arch should be run to form a ground on which the enrichments may be modelled. Fibrous plaster is well adapted for constructing the plaster lining of cupolas.

PANELLED BEAMS.—When panelled beams have mouldings on the lower part of their sides or faces, and on the soffit to form a sunk panel, they may be run in two parts. Screeds are formed on the two sides, and one in the centre of the soffit. If the mouldings on the sides have more girth or are larger than the portion on the soffit, they may be run from rules fixed on the side of the beam, with the nib bearing on the style or on the soffits. If the style and mouldings on the soffit are small, the mould is made to run the face, style, and soffit moulding in one. If the styles are broad, the moulding on the sunk part of the soffit is run from a parallel running rule fixed in the centre of the soffit, thus forming a double rule to run each side of the sunk moulding. The latter way is most generally used. The end or other mouldings required for panelling the soffit are run down and planted.

All beams of any length should always have a camber, not only to allow for any settlement that may take place, but to make it more pleasing to the eye. A beam dead level and straight has the appearance of sagging in the centre. This may be termed an optical illusion.

TRAMMELS FOR ELLIPTICAL MOULDINGS.—It may at once be pointed out that an ellipse and an oval are not the same. Both ends of an ellipse are similar, and an oval is egg-shaped, one end having a greater curve than the other, therefore the term oval moulding or panel is scarcely correct when applied to the following illustrations. This term, however, is best known and generally used by most workmen in the building trades. The term "elliptical" is generally applied by plasterers when referring to mouldings where the whole ellipse is not carried round, such as for mouldings on elliptical arches, windows, &c.; and the term "oval," where the whole figure is completed, such as panels elliptical on plan, formed on walls or ceilings. In consideration of the common usage of these terms, they will here be used in describing the setting out or working of same.

Trammels are often used for running oval panel mouldings, and for forming the lines when setting out oval templates. Trammels are made of wood or metal. A simple way to make a trammel for small work is to sink two grooves at right angles in a hardwood board (termed the plate), about 7 inches long, 5 inches wide, and 1 inch thick. The grooves are about $\frac{1}{2}$ inch deep and $\frac{1}{2}$ inch wide. Two hardwood pins are then made to fit the grooves. They have collars to bear on the surface of the plate. The upper part is made round to fit the centre holes of the rod. The subjoined illustration No. 39 shows a template, and various sorts of template pins. Fig. 1 is a view of a template, with the two pins, rod, with the running mould attached in position, and a part of a moulding. Fig. 2 shows various sections of pins. A is the section of the pin as used in Fig. 1, and C is the plan of the pin at the intersection of the grooves. B is the section of a dovetailed pin used for another form of trammel. The rod is made to any desired length, so that it may serve for various sized ovals. The average size for this kind of trammel is about 1 foot 6 inches long, 1 inch wide, and $\frac{1}{4}$ inch thick. A series of holes $\frac{1}{4}$ inch in diameter (to fit the head of the pin) is made about $\frac{1}{8}$ inch apart on the flat side. The first hole is made near one end of the rod, and continued down the centre for about 15 inches, leaving the blank space for screwing on to the running mould. A pin is now laid into each groove, and the size of the desired oval is obtained by regulating the length of the rod at each diameter by means of the holes. The pin in the short groove is the point from which the length of the oval is taken, and the pin in the long groove for the width. The trammel is fixed on the running board by means of two or more screws, as shown. This size of trammel can only be used for oval mouldings from about 10 inches to 36 inches at their longest diameter, therefore larger sizes are required for larger ovals.

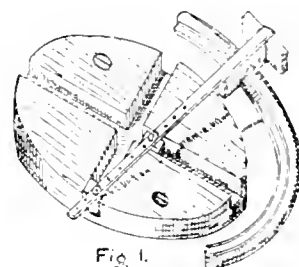
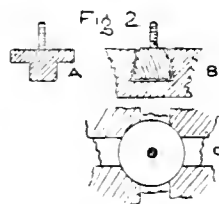

Fig. 1.



No. 39.—TRAMMELS.

A trammel for running large ovals (say from 6 to 10 feet at the major diameter), if made solid, as shown in Fig. 1, would be too heavy and cumbersome for fixing on ceilings, where the mouldings are run *in situ*. A lighter kind, termed a "cross" template, is made as follows:—Cut three flooring boards, one a little less in length than the longest diameter of the proposed oval, and two less than the short diameter. Lay them down on a floor in the form of a cross (similar to the grooves in Fig. 1), and fix and brace them together. Four angular braces will hold them together, and allow the whole to be fixed on the ceiling. On the centre of this ground make two lines at right angles to each other, and from these set out the width of the desired grooves at the ends and intersections, and then fix wood fillets, each about 1 inch thick and 2 inches wide, to the marks, thus forming the grooves. In order to prevent the pins dropping out of the grooves when the trammel is fixed face downward on the ceiling, the inner sides of the fillets should be splayed so as to receive dovetailed pins, as shown at B, Fig. 2. This may also be effected by fixing running rules on the fillets so as to overlap about $\frac{1}{4}$ inch, over the groove space, thus forming rebated or square grooves. The pins are made with shoulders to fit the grooves. In both modes a linch-pin must be inserted in the trammel pin to prevent the rod dropping.

A strong, accurate, and permanent trammel can be constructed entirely with metal. To make this, procure a sufficient length of metal tube, about $\frac{1}{2}$ inch in diameter, having a slot about $\frac{1}{4}$ inch wide, cut longitudinally. Cut the tube into four pieces, mitring the intersections, and fix and brace them together in the form of a cross, as already mentioned. A pin made to fit the slot,

fixed in a ball made to fit the tube, completes one of the sliding pins. The rod may be made of metal or wood, but the latter gives more freedom for changing the size for different sized ovals.

Various methods are employed for running oval panel mouldings on ceilings. The most useful are by means of trammels, or wood or plaster templates. A trammel is a good instrument for running oval panels where the mouldings are not wide. Wide mouldings (say over 1 foot) cannot be run true or uniform in width in one operation with a trammel, because the running mould, which is fixed on the end of the rod of the trammel, assumes a raking position when it is between the right angle points of the major and minor diameters of the oval. This raking position takes place at the four joints or change of curves of the oval, and is more pronounced in extra wide mouldings. This difficulty is overcome by running the moulding in two parts, using a trammel mould for running the first or inner part, and a running mould (horsed to run on the run part) for running the second or outer part. This is effected by dividing the section of the moulding into two parts, taking care to make the joint at the side of a fillet or in the centre of a flat member at the outer side of the part to be run with the trammel mould, so as to allow for a good bearing wide and strong for the slipper of the running mould used for running the second part. The running mould for the first part is fixed on the rod of the trammel as already mentioned. The running mould for the second part is horsed with a circular slipper cut to fit the curve of the first moulding. If the oval has quick curves, a slipper with two pins will give the best results.

If there is an enrichment in or near the centre of the moulding, run the moulding in three parts, using the bed of the enrichment (which is run with a trammel mould) as a centre running rule for running the outer and inner parts, which are run with circular or pin-slippered running moulds, as already described. It will be seen that by using either of these three methods, wide mouldings for oval panels can be run uniform in width; the trammel mould giving the form of the oval to the first part of the moulding, or to the centre running rule, and the curved slippered running moulds giving the desired uniformity of width to the full section of the moulding. Most forms of oval panel mouldings are best run with templates. When run with trammels, or with radius-rods, the running mould is apt to jump and cause cripples at the junction of the major and minor diameters.

TEMPLATES FOR RUNNING ELLIPTICAL MOULDINGS.—The true form of an ellipsis can only be derived from the diagonal cut from the cone or the cylinder, and the nearest approximation to this curve must be obtained by continuous motion. There is no other instrument so well adapted for effecting this purpose as a trammel. For a true ellipsis, make the distance from the outer end of the rod to the nearest point or centre pin equal to half the shortest or minor diameter of the ellipsis, and from the centre pin to the outer pin equal to half the longest or major diameter. This shows the use of a trammel for setting out the lines to make a template for this form of ellipsis.

The subjoined illustration (No. 40) elucidates the method of setting out another form of ellipsis; also an oval having its major axis one-third greater than its minor. This also shows the template and a pin running mould in position for running an elliptical arch moulding. The template (Fig. 1) is made to extend below the springing line of the arch, so as to allow the mould to be run down to the spring of arch and save mitring. The template for running the arch extends to the shaded part; but to utilise the space the curve has been continued round to show a method of setting out a template from which an oval moulding can be run, the oval having its major axis one-third greater than its minor. The method of setting out is as follows:—First draw the line A B, the greater diameter, to the desired length; then bisect it, and erect the perpendicular line C D; this line being the lesser diameter, is made a third less than the line A B. Then bisect each half of the line, which will divide the line A B into four equal parts and give the centres E, E, which

are the centres for describing the ends, as from F to F, and F 1 to F 2. Then from the centres C and D describe the flat curves from F to F 1, and from F to F 2, which complete the oval. It is, however, better to set out this template by the trammel, as the junction of the segments of the circles always has a more or less crippled look.

Fig. 2 shows a "pin-mould" in position when running an elliptical arch moulding. This mould is provided with two hardwood pins inserted into the bearing face of the slipper. The pins bear on the edge of the template, and owing to their position, and being apart, allow the mould to take any change of curve without "jumping."

Before running elliptical mouldings on arches or windows, the centres and running rods should be tested, so that the mouldings will intersect accurately, and so avoid jumps at the change of curves. All centre pins should be level with each other, and equidistant from the centre of the arch or window. The outline and intersections of the proposed moulding can be tested by temporarily fixing a pencil on the outer and inner profiles of the running mould, then working the mould over the screeds, so that the pencils will form two lines. I have heard of a three-centred elliptical hood moulding being run over a window with what is called a "bolted radius-rod." This rod is made in two parts and connected with a hinge, and held straight when running the long diameter with a bolt and sockets where fixed at the joint. The running mould is fixed on one end, and a centre plate on the other in the usual way. The long diameter of the moulding is run first, and when the radius-rod reaches the change of curve the bolt is drawn back, and the short diameter of the moulding run with the short part of the radius-rod. A nail is inserted in a board which is previously fixed in the window opening. The nail must be fixed in a line with the change of curve so as to stop the radius-rod, and hold the long part in position while the short part is working. The same operation is repeated for the other side of the work. It is needless to say that this method is far too complicated to be serviceable for general purposes.

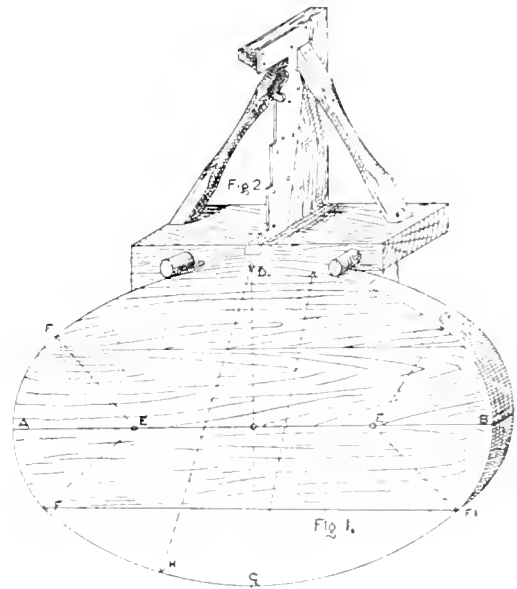

NO. 40.—TEMPLATE AND PIN-MOULD FOR RUNNING ELLIPTICAL ARCH MOULDINGS.

Templates are useful for running most forms of elliptical panel mouldings. Plasterers may make their own templates or running rules by using fibrous plaster casts as a substitute for wood. This is effected by first setting out a quarter of the proposed oval panel, then cut out or run a temporary plaster running rule to fit the inner line, allowing a space for the slipper of a running mould. Cut a reverse running mould to the section of the proposed fibrous plaster rules—say about 1 inch thick and 3 inches wide, then run the quarter length of the oval, and after making true joints at the ends, cast four fibrous plaster quarters, and then lay and fix them reversely, thus completing the full oval template or running rule. The full oval running rule can also be run *in situ* and in one operation. This may be done with a trammel or with radius-rods, according to the form and size of the panel. Strong and stiff gauged plaster or a strong white cement should be used for the running rule, to enable it to resist the friction of the running mould while running the moulding.

Radius-rods are more often used for setting out the lines for oval templates than for running the mouldings. Circular mouldings—vertical, horizontal, or angular—run off circular grounds require special running rules, so that they will take or bend to the double curvature. For this purpose, cane, flexible metal pipes, and wooden rules, having series of saw-cuts on the backs and sides, have been used, but cast fibrous plaster rules or a jack template are more suitable for most of these purposes. Templates can also be made by means of a plasterer's oval.

PLASTERER'S OVAL.—The subjoined illustration No. 41 elucidates the setting out of this form of oval to any given size, also the method of forming two oval mouldings from two circle mouldings. The ovals are formed by running two circular mouldings in plaster, the diameter of one being exactly double that of the other. Each circle is cut into four quadrants or quarters. Two of the quadrants of the larger circle form the sides of one oval, and two quadrants of the smaller circle form the ends, the four segments making a fairly good oval. The remaining segments constitute another oval of similar size and shape. The method is simple and speedy, and it can also be employed for the formation of elliptical mouldings on arches, doors, or windows as well as for oval panel mouldings. The formation of ovals by this method has been employed by plasterers

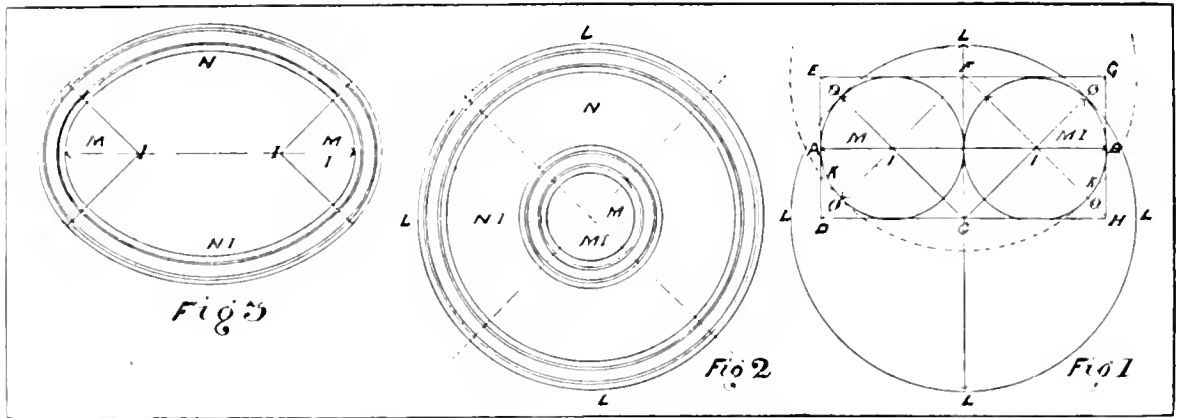

NO. 41.—SETTING OUT AND CONSTRUCTING PLASTERER'S OVAL.

for generations, but owing to the want of a definite rule for setting out this form of oval to any given size, its use has been somewhat limited. To meet this want, I have invented a method which can be adopted for most purposes, and which I give here for the first time.* For want of a better name, I have called this a "Plasterer's Oval," for the reason that plaster lends itself more readily than any other material to the formation of circular mouldings. No one in the building trades can form a circle or an oval moulding so quickly and accurately as a plasterer. The method of setting out and of constructing this form of oval is as follows:—

To set out an oval to a given size, the greater diameter being given. Take this greater diameter as a base to determine the required diameters of the large and small circle mouldings, M and N, Fig. 2. Let the line A B, Fig. 1, be the given diameter, say 3 feet; on this form two squares, each according to their diameter would be 1 foot 6 inches by 1 foot 6 inches, as shown at C D E F and E G H C; then draw diagonals in each square as at C E and D F and C G and F H and at their

* After the above was in type, Mr Robinson informed me that this method of setting out this form of oval was described and illustrated by Vignola in 1593. Not having seen Vignola's work, I am unable to say if his method is exactly the same as that given here.

intersections I and I as centres draw the circles I K and I K. The radius in this example would be 9 inches. The quadrants M and M I correspond with the same letters in Figs. 2 and 3, and they form the two ends of the oval. After this take C as a centre, and with a radius from C to O at E or G describe that part of the circle L from O L O, which forms the upper side of the oval; now take F as a centre, and with the same radius describe the lower side, joining K K at O and O, thus forming the plan of the oval as shown by the line A L B, and the dotted line below C. It will be seen that the respective centres to describe this figure give the centres and diameters to run the two circle mouldings from which the ovals are formed.

To construct the oval, first make a running mould to the desired profile, using a radius-rod in the usual manner, for running circles on the flat. Before running the mouldings, set out two lines at right angles on the moulding board, taking care to extend the lines a little beyond the outline of the large circle, as shown by the dotted lines Fig. 2. The extended parts of these lines act as guides for cutting the moulding into exact quadrants. The intersection of them is the centre from which both circles are run. Apply the running mould, and turn it round, so that it leaves a faint mark on the running board to indicate the width of the moulding to be run. The width can also be marked by the aid of a pencil, holding it at the outside member, and turning the mould round, repeating this operation on the inside member. On this space drive in eight tacks, two in each quadrant, leaving the heads projecting about $\frac{1}{2}$ inch. The object of these tacks is to prevent the moulding from lifting owing to plaster swelling, or from moving round while being run. Cover the tacks with clay to allow the moulding to be freely taken up after it is run and cut. The moulding is then run in the usual way, and is cut into four quarters or quadrants. This is done by applying two set-squares, one inside and one outside of the moulding; and at one of the quarter lines lay a straight-edge over the moulding and against the set-squares. The moulding can then be marked or sawn at the proper place and angle. The dotted or quarter lines divide the mouldings into quadrants, and give the angles for cutting them.

The use of extending the lines beyond the moulding will here be seen. A part may be obliterated while the moulding is being run, but the extended part will afford a correct guide for the outside set-square. If the quadrants are cut fine, square, and clean, the joints will be scarcely perceptible when the four segments are placed together. When this circle is cut and taken off the board, the radius has to be altered to exactly one-half of the large circle, and the small circle is run and cut precisely in the same way as the large one. The four quadrants can now be fixed to form an oval, as shown in Fig. 3. If a quantity of oval mouldings be required, a casting mould can be taken off this oval in which they may be cast. It will be seen that the quadrants X and X I form the sides of the oval in Fig. 3, and the quadrants M and M I form the ends. It will also be seen that after completing this oval there are four quadrants left to form another oval. If but one oval is required, run only one-half of each circle, allowing a little space beyond the centre line, so that a square and clean joint can be cut. A thin saw with fine small teeth should be used for this purpose.

Fig. 3 shows the four segments of the moulding in position forming the oval. In this figure the moulding is struck on the outside of the setting-out circle line, as shown in Fig. 1, but the moulding in Fig. 2 is struck on the inside of the setting-out lines. This is simply to show that the same centres can be used for mouldings struck on either side of the lines.

A mould for casting oval mouldings, also templates, can also be made by the above process. For this purpose a reverse running mould must be used for running the two circles. A plaster piece mould for casting oval mouldings that are undercut may also be formed by this method. In this case the running mould must be made and used as described for "reverse moulds."

COVED CEILINGS.—Coves to ceilings are of various heights, as one-third, one-fourth, one-fifth, &c., of the whole height. The form of the cove is generally either a quadrant of a circle or of an ellipsis, taking its rise a little above the cornice, and finishing at the crown or other moulding. If the room is low in proportion to its width, the cove must likewise be low; and when it is high, the cove must likewise be so; by which means the excess of height will be rendered less perceptible. An example of two coved ceilings from designs by James Gibbs are shown in the annexed illustration No. 42. Fig. 1 shows the plan and elevation of a coved ceiling, with circular windows between the groins. Fig. 2 shows the plan and elevation of a coved ceiling, the design of which is less intricate than that of Fig. 1. The curve of this cove is a quadrant of a circle, as shown by the section at the side. The plans will enable the section of each design to be understood, and *vice versa*, and the whole will render the method of constructing coves and circular mouldings on

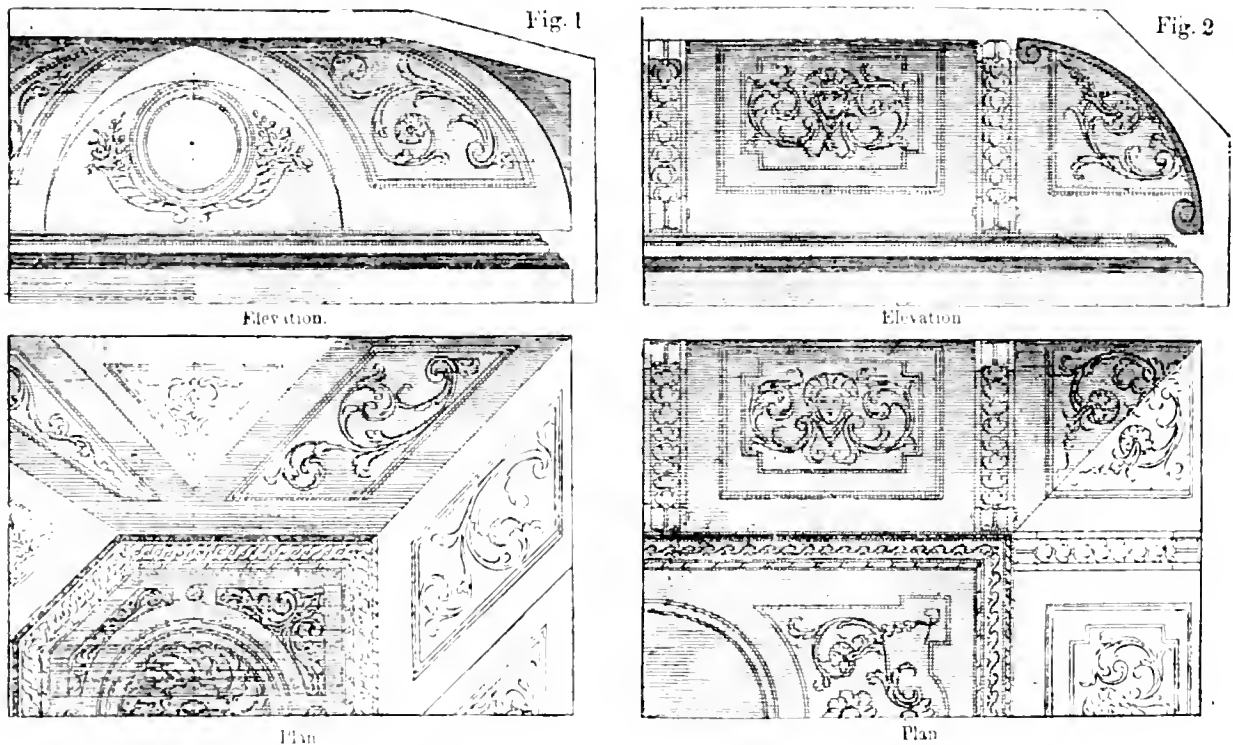

NO. 42. PLANS AND ELEVATIONS OF COVED CEILINGS.

circular surfaces which is given hereafter to be more clearly understood. The external and internal angle mouldings in these coves may be formed with a jack template or as described for coves.

CIRCLE MOULDINGS ON CIRCULAR SURFACES.—The accompanying illustrations, Plates XL and XLI, are given to elucidate various methods of running circular mouldings on circular surfaces. Fig. 1 Plate XL shows the elevation of a cove suitable for an aquarium or marine hall. The external angle rib moulding, C, and the panel rib moulding, D, spring from the top or weathering of a main moulding, and intersect with a horizontal or crown moulding at the top of the cove. The section of the horizontal moulding is shown at G, and the section of the panel moulding is shown above D; the section of the external rib being of course double that of the panel moulding. Where circular and straight mouldings intersect with each other, it is advantageous in most cases to run the circular mouldings first, so that the whole of the moulding can be run, and leave the intersection to

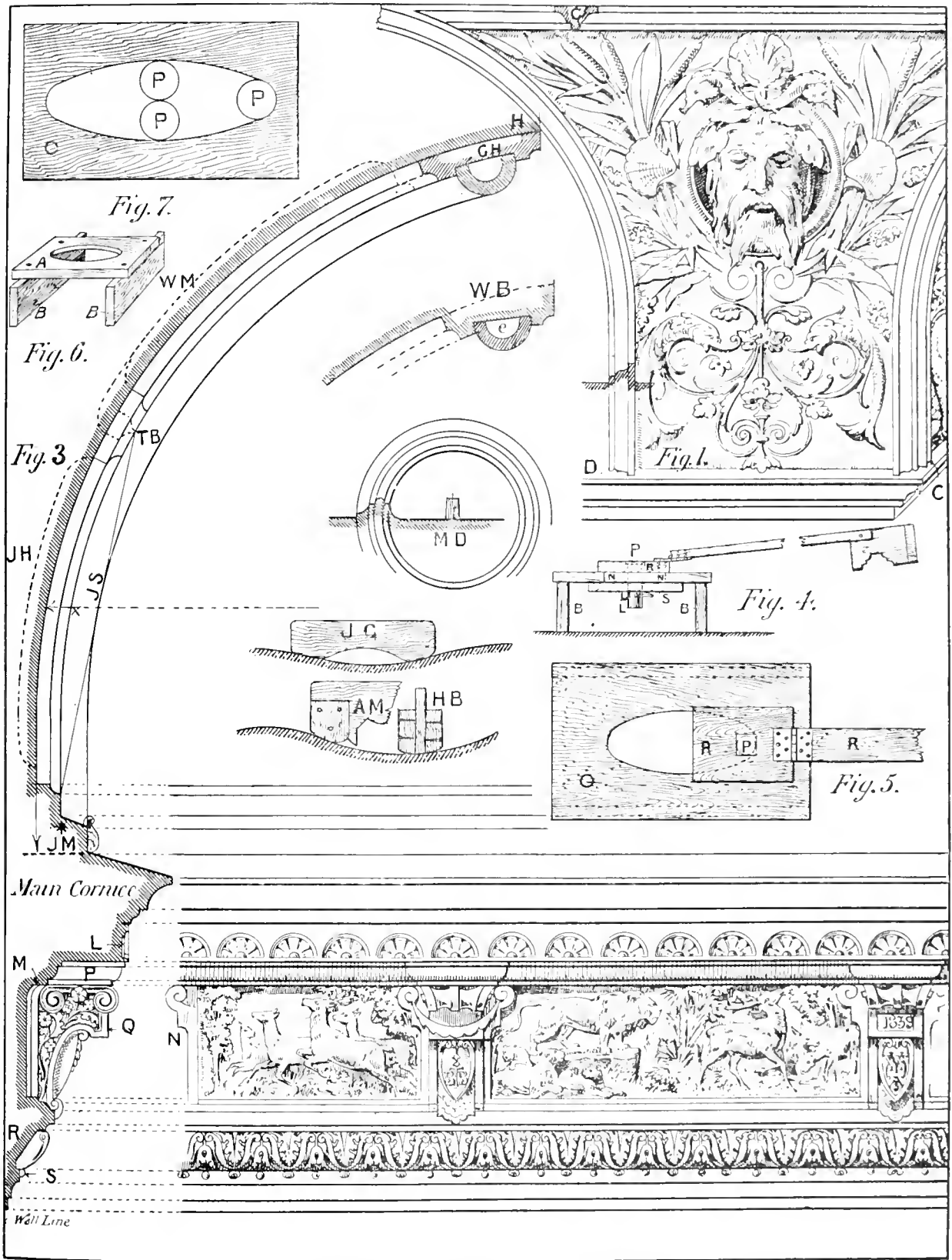

CIRCULAR MOULDINGS ON CIRCULAR SURFACES.

FIG. 1.—ELEVATION OF SMALL COVE, WITH SECTIONS.

FIG. 3.—SECTION OF LARGE COVE, WITH SECTION AND FILIGREE OF MAIN CORNICE.

be mitred on the straight part, which is naturally the easiest part. In some examples it is not advisable to run the circular part first. For example, if the crown or horizontal moulding, as shown at G, Fig. 1, was the lower part of a large crown moulding made to intersect with small cove mouldings, it would be best to run the straight moulding first, and then cut away as much of the straight moulding as will allow the nib of the running mould to pass while running the circular moulding. For the section in this example there would be very little mitring to do, as it would simply be a butt mitre up to the back of the circular mouldings. The external rib moulding, c, is best run with a jack template. The circular panel mouldings—one-half of a moulding is shown at D) can be run by two methods. By the first, the moulding is run in three parts, using a sledge-slipped running mould fixed on a hinged radius-rod, and the two straight parts are run from running rules. By the second method, the whole moulding is run at one operation by using a fibrous plaster template, made as already described.

The circle panel, containing the head of Neptune, is run with a raised centre block, as shown at M D, a plan and section of the panel. The use of raised centres will be seen later on.

The section of a large cove and main cornice—with the elevation of the cornice—is shown at Fig. 3, on Plate XL., and the elevation at Fig. 3a from A to B) on Plate XLI. In describing the method of working this cove, the terms "section" and "elevation" will hereafter be used, instead of referring to the numbers of the above plates. The main mouldings of the cove are the horizontal or crown moulding at the top—as C H) on the section, and A) on the elevation, and the horizontal or foot moulding at the springing, as at J M) above the dotted line on the section on Plate XL., and at B) on the elevation (Plate XLI.), and the vertical or rib mouldings—as from J M) to C H) on the section, and from A) to B) on the elevation. The terms "crown," "foot," and "rib" mouldings, being generally employed for the vertical and horizontal mouldings, will hereafter be used when describing the setting out and working of same.

The oval, circle, and Gothic-pointed panels shown in the elevation on Plate XLI. are given to illustrate the method of setting out and running the mouldings, and not as a complete design. In order to render the setting out and construction more clear, the various lines and parts of the sections and elevations are first described. The main ground section of the cove—indicated by shading—springs from the weathering of the main cornice, as at J M), and terminates at H) at Fig. 3. The crown moulding, C H), is shown without a lathed bracket, so that the section and intersection with the rib mouldings will be more clearly understood. The dotted line, J H), outside the main section is the section of the background of the circle panel, and the dotted line, W M), is the section of the background of the pointed panel, the elevations of which are shown at Fig. 3a) on Plate XLI. These lines, when continued in one line at the centre, as from J H) to W M), give the section of the background of the oval panel. The main section line of the cove (Fig. 3) taken from the star at J M), in conjunction with the dotted line J H) up to T B), and continued up to the cavetto of the crown moulding under H), gives the section through the circle and pointed panels from dart to dart, as shown on the elevation Fig. 3a). The intersection of the circle and pointed panels is shown at T B) on the section Fig. 3. The oval, circle, and pointed panels will hereafter be termed circular panels.

The main cornice (Fig. 3) is ornamented with various enrichments, which are shown on the section and elevation of same. L) is the bed and section of an enrichment sunk on the face of the corona; M) is the bed and section of a frieze and truss having side brackets; N) is the elevation of one of the side brackets. The trusses divide the frieze into compartments; this allows for a variety of illustrative subjects. The animals which I have introduced, as a change from the ordinary foliage, may be found suitable for a natural history museum or similar buildings. Q) is the profile, and P) the

cap of the truss. R is the bed and section of the architrave enrichment. The balls or husks at s, which are part of the architrave, are cast separately, and fixed after the main part of the enrichment is fixed. The main cornice is run from a nib rule fixed on the weathering, and a running rule fixed on the wall.

The intersections of the enrichment in the rib and crown mouldings are sometimes stopped or further enriched by means of a pendent patera, as shown on the elevation (Fig. 3a, Plate XLII.). When the enrichment springs from left to right, as shown in the centre of the circular panels, a pendant is also used as a springing point. A half section of the patera is shown at C M. The dark part indicates the half section of the enrichment. The intersection of the enrichment may also be made by modelling ribbons over the mitres, as shown at A B, at the right hand or half rib. The springing leaf shown near B on the elevation is sometimes used to make a better and bolder beginning for the rib enrichment. Another form of springing leaf is shown at E F. This has the same section in the centre as the first springing leaf, as shown near J M at Fig. 3.

With regard to floating, screeding, and running the cove mouldings, care must be exercised when setting out and horsing the running moulds for the rib, crown, and foot mouldings, also for the circular panel mouldings, so that they will intersect accurately with each other. The screeds must also be made to intersect to allow the mouldings to be run true at their intersections. When crown and rib mouldings intersect together at right angles on the same ground section, as at C H, Fig. 3, the intersection is easily made and pleasant to the eye; but if the rib moulding intersects with a crown moulding on a level ground, or where the outer members are square or perpendicular, as shown at W B, the intersection is not so easily made or so pleasant to the eye. The transition from the circle to the straight, or in other words the intersection of the circle with the straight mouldings, is sometimes formed in the bed of the enrichment, as shown at c on the section at W B. Owing to a lack of attention in setting out the various running moulds, or in forming the screeds, the ribs do not intersect correctly with the crown and foot mouldings. In this case the mouldings have to be eased when the mitres are "put in" to make them more linable and pleasing to the eye. This kind of mitring is then said to be "humoured."

With reference to the order of running the main mouldings, namely, the crown, foot, and vertical mouldings, also the inner panel mouldings, such as the oval, circle, or pointed panels, the main mouldings should be run first, so as to avoid mitring the panel mouldings, which being circular on circular grounds, are more difficult to mitre than the crown and foot mouldings, which are straight, or even the rib mouldings, which are only circular on section. After the main mouldings are run, parts of the inner sides are cut off to allow the nib of the running mould to pass when running the circle panel mouldings. These parts are mitred and made good after the circular panel mouldings are run. In order to avoid stuff falling on run parts, the crown moulding should be run first, the ribs next, and then the foot moulding. The latter should be covered with old paper or sacks, to prevent stuff falling on while running the circular panels. The crown and rib mouldings are run on screeds formed on the bed of the centre enrichment, as shown at R M, Fig. 3a, which is a section of the moulding and the enrichment. The ribs are run in two parts—one running mould will do for both—from a parallel running rule fixed in the centre of the section, as shown at D K. The crown moulding is run in a similar way, but two different running moulds are required, one cut for the inner and one for the outer section. The foot moulding is run in one operation, or in two sections, according to the size and form of the moulding. The main running mould for both ways is horsed to run on a nib screed and a slipper screed. The latter is formed on the weathering of the main cornice, on which a parallel running rule is fixed. This rule is also

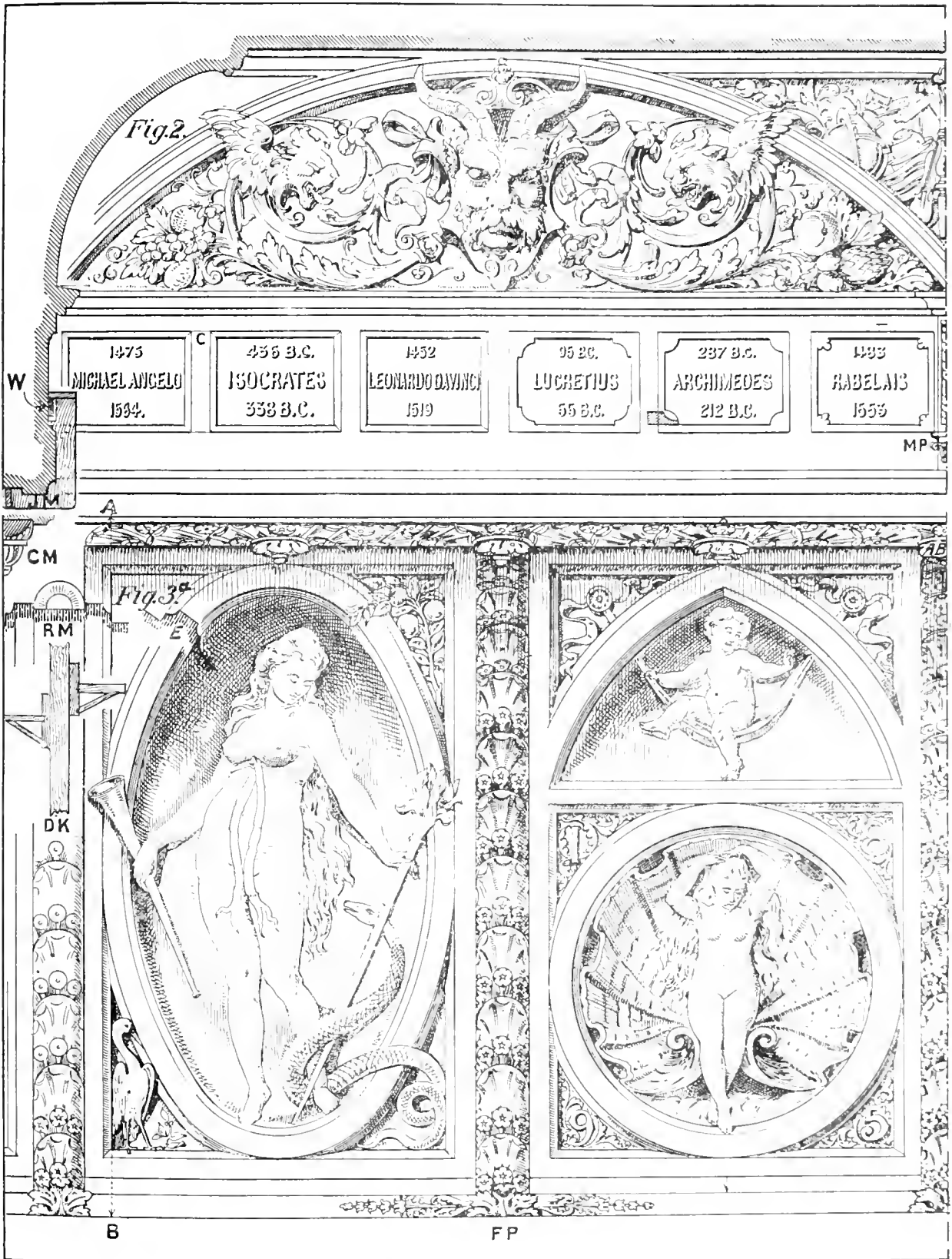

CIRCULAR MOULDINGS ON CIRCULAR SURFACES.

FIG. 2.—COMBINED SECTION AND ELEVATION OF COVE AND PANELED FASCIA MOULDINGS.
FIG. 3a.—ELEVATION OF LARGE COVE, WITH OVAL, CIRCULAR, AND CIRCULAR POINTED PANELS.

used as a slipper rule when running the foot moulding, and as a nib rule when running the main cornice.

Contrary to the order of working in practice, the method of running the various mouldings has been first described, so as to make the method of screeding more clearly understood. The screeds are based on a series of dots, which are made at the most suitable places. For the crown moulding, the screed dots are made on the brackets at the bed of the enrichment, as already mentioned. These dots are made across the bed, and each one must be made level crosswise, as well as all being made level from end to end of the cove. As the crown and rib mouldings form the base of the enrichment, the dots and screeds should be composed of gauged coarse stuff, so as to give a sound foundation for the enrichments—in fact, all screeds for this class of work should be formed with gauged stuff. The first two dots are made on the crown bracket, one at each end of the cove, keeping them level crosswise, and from end to end, as already mentioned. Two or more intermediate dots, according to the length of the cove, are made, keeping them linable and level with the dots at the ends of the cove. The screed is then laid and ruled off with a long floating rule. A narrow screed is then made in a similar way on the bracket of the foot moulding. This screed must be made on a member, on the same plane as the bed of rib enrichment, so as to form a bearing for forming the rib screeds. This screed also acts as a nib screed for running the lower part of the foot moulding, and a slipper screed for running the upper part. The joint between the two is set by hand.

Where the size or form of the moulding permits, the whole of the foot moulding can be run in one operation from a slipper screed made on the weathering, and a nib screed made on the inner surface of the cove. In this case dots are formed at the foot of each rib to act as bearings for forming the rib screeds. The screed on the weathering must be made level from end to end of the cove. The rib screeds are ruled off with a circular rule cut to the desired section, using the crown screed and the foot screed or the dots, as the case may be, as bearings. Screeds for the nibs of the crown, rib, and foot running mould must also be made. These screeds are also used for floating the cove surfaces between the main and circular panel mouldings, as shown between the section of the rib moulding, R M, and the section of the circular panel moulding, E on the elevation, Fig. 3a. These screeds and the floating of the angular surfaces are formed in the same way as described for cupolas. The running rules for the crown and foot mouldings must be fixed equidistant, as from A to B on the elevation. This is tested with a rod cut to the required length. The running rules for the vertical ribs must also be fixed equidistant. This is effected by setting out the centres of each on the crown and foot mouldings or screeds, as the case may be, from end to end of the cove. This method, if accurately done, also gives a guide for fixing each rib running rule exactly vertical. This can also be tested by hanging a plumb-bob from the top marks, and applying a large set-square at the marks on the foot screed, or by boning the cord with the eye.

After the main mouldings are run, a part of the inner sides, where the circular panel moulding intersects, is cut off to allow the nib of the running mould to pass while running the circular panel mouldings. The screeds at the top, bottom, and sides are made up with the aid of a gauge-rule, made to bear on the run parts. The circular panel moulding being run with a radius-rod or on a template, the running mould is cut to run a part of the inner ground of the panel, and is horsed with a slipper on the outside, therefore an inner screed is not required.

The construction of circular mouldings on circular grounds requires special methods, especially if they intersect with other mouldings, as shown in the present example, so that they will be true and intersect accurately. A circle moulding run on a circle ground with a radius-rod running mould

would not be a true circle on plan. The curve at the springing and crown of the circular ground would be flat, and have the form of a stunted oval. This difficulty is overcome by various methods. One is by raising the centre pin by means of a block. For example, take the section of the circular panel at J H, on the main section of the cove (Fig. 3). The chord line, J S, is taken from the arris of the member of the moulding which touches or meets the corresponding member of the foot moulding, and up to the same member above, as at T B. If the centre pin was fixed on the ground surface at the dart of the horizontal line indicated by the dotted line at J S, the radius-rod would then form a true circle on the horizontal line, but the circle would be flat on the vertical line. If the centre was raised, say to X, the radius-rod would decrease the diameter of the circle at the horizontal line, but it would extend the diameter at the vertical line. Therefore in order to allow the circle moulding to be run true or intersect with the square panel mouldings, the height of the centre and the length of the radius-rod must be regulated until the desired points at the horizontal and vertical lines are equalised. The oval panel shown on the elevation (Fig. 3a) may also be run with a template. To make a template for this purpose, first make a flat template to the desired size of circle on plan, then lay it over the circular ground, and project the circle on to the ground, then from the projected line or points form a plaster template or running rule on the ground. The pointed panel is run with the aid of a radius-rod and two centres. The oval panel may also be run with a template made as described for the circle panel.

Another way that I have introduced for this purpose is by the aid of a "trammel-centre." With the use of a trammel-centre, the oval moulding is run with a radius-rod working from a miniature oval formed in the trammel-centre and fixed at the intersection of the right angle lines of the major and minor axes. The trammel-centre is made by first setting out on a board (called the centre board) a small oval made to the scale of the full size of the proposed oval, then cutting out the oval, and fixing the board on two blocks to act as a raised centre. The centre pin is inserted in the centre board, and held in position with a sliding board on the top to prevent it from falling down, and with a sliding board on the under side to prevent it from rising, thus allowing it to work freely and bear on the rim of the oval. The method of construction and working is further elucidated by the sketches at Fig. 4, Plate XL. This shows the end section of the trammel-centre, with the radius-rod and running mould attached. B, B, are the blocks on which the centre board is fixed, and the lines at X, X, indicate the narrow width of the oval in the centre board. The two blocks form a raised centre, and allow the centre pin, P, to work freely. The centre pin is circular on plan up to the top surface of the centre board, where it becomes square, to allow of its being readily and strongly fixed into the upper part. This part forms a sliding board which bears on the centre board. The centre pin is prevented from rising by means of the sliding board, S, and further secured by means of a lynch-pin, L, inserted through the foot of the centre pin. The radius-rod is jointed, and connected with a flap-hinge, to allow the running mould to negotiate the various curves by rising and falling. In this sketch one-half of the hinge is shown fixed on the under side of the radius-rod, and the other half on the upper side of the radius pin, as shown at R—this is really a part of the radius-rod—to allow the running mould to fall or work below the level of the centre if required.

Fig. 5, Plate XL, is an enlarged view of the plan of the upper side of the trammel-centre. O is the centre board, R the sliding part of the radius-rod, with the square head of centre pin, P, and connected to the long part of the rod. In this sketch all the hinge is fixed on the upper side of the radius-rod. Fig. 6 is a perspective view of the centre board, A, and the blocks, B, B, before the centre pin and radius-rod are inserted. Fig. 7 is an enlarged view of the plan of the centre board, showing the centre pin, P, in three positions, as it works round and against the edge of the oval centre.

Fig. 2, Plate XII., shows the section and elevation of a cove, with a long segmental rib moulding springing from the weathering of the cornice above a panelled fascia, and intersecting with the crown moulding of the cove. The crown moulding is run first and the rib next. The crown moulding is run from a slipper screed formed on the cove, and a nib screed formed on a ceiling or on the outer member of the mouldings, which may be on the fascia of a lantern light, according to the design. The rib moulding is run with a radius-rod from a raised centre. The part of the crown moulding which intersects with the rib moulding must be cut off to allow the nib of the rib running mould to pass. This part is mitred and made good after the rib is run.

The cornice above the fascia, the upper and lower longitudinal mouldings of the sunk panels of the fascia, and the soffit, are run in two parts. The upper part is run from a running rule fixed on a screed formed on the ground of the sunk panel, as shown at W, and a nib rule fixed on the weathering of the cornice. The lower part is run with a "hanging mould," J M, from the same running rule, W, as used for the upper part, and a nib screed formed on the soffit. The styles, C, are run down or cast, and then planted. The lines at the top and bottom of the style, C, indicate the joints of the planted part before they are stopped. In some examples the mitres or angles of the panels take the form of moulded curves. Three examples of moulded angles are shown in the sketch. Moulded angles are made after the panel mouldings are run. If they are of an intricate design, a model of one is made and then moulded, cast, and planted; but if of a simple form, they are formed *in situ*. This is effected by cutting a template to the desired section, and fixing it temporarily in position at the angle, and then filling in the space with gauged stuff. Another way is to lay a little over the desired section with stuff, and then apply a template over the stuff, and use it as a guide for cutting the section. The combined plan and section of a template for forming the angles of the fifth panel is shown by the shaded part on that panel. The names of eminent men in art, science, and literature, with the dates of their birth and death, in the sunk panels of the fascia, are instructive as well as being decorative. The names and dates may be stamped in the soft plaster, or cut out when it is hard. They may also be cast on a ground, and then planted. The half elevation and section of a moulded pilaster is shown at M P. Moulded pilasters are sometimes used to divide a long series of small panels into compartments, and sometimes to act as a support for overhead mouldings. The pilasters are cast, and then fixed after the mouldings are run. The cove enrichments are generally cast with a background, and then planted after the mouldings are run. For small work, the rib and crown mouldings and the enrichments can be cast in one piece. The work done by this process is not so linable, and the joints are apt to be more or less noticeable. Joints in enrichments are not nearly so noticeable as those in mouldings.

Mouldings circular in form and circular on plan, elliptical or diagonal mouldings on arched or coved ceilings, or on concavo-convex surfaces, require special forms of running moulds, so that the slippers and nibs will bear and run accurately on the screeds and form the mouldings true and without "jumps." The short oval nib slipper for Gothic ribs has already been described. Another kind of slipper, termed a sledge, is particularly useful, and may be relied upon to work irregular curved surfaces without broken lines or jumps. A side view of a sledge-slipper on an irregular curved surface is shown at J G on Plate XI. The nib—termed a "bull-nose nib"—for a sledge-slippered running mould is rounded off so as to present only a small bearing surface. A side section of a bull-nose nib is shown at A M, and an end section at H B. Another nib which will fit any curve is formed by the aid of a patent castor. This is simply a metal ball working inside a metal cup, the end of the cup being cut off so as to allow the ball to work on the ground or screed. A running mould for concavo-convex surfaces is described and illustrated in Chapter XI.

The decorative plaster work displayed in Plates XL. and XLI. can be executed by two methods, the first by "direct modelling" or modelling *in situ*, and the second by moulded and cast work. It is sometimes of advantage to execute work *in situ*, but the modeller or plasterer must in his own mind balance the advantages and disadvantages of this method over moulding and casting. Although these processes have been fully described in Chapter VIII., it may be advisable to refer to them here as the work is illustrated in order that their respective merits be fully known and appreciated.

With the exception of the half-round enrichment in the rib and crown mouldings, and the enrichments in the main cornice the frieze excepted, all the ornamental work, human and animal figures, foliage, flowers, fruit, &c., in these examples, can be most effectively modelled *in situ*. If the work is carried out in this way, the effects of light and shade and balance when in position may be better observed, and defects readily adjusted, and a greater variety of design and details can be and is generally employed in this method, but expense of course must enter into the calculations of the modeller, although in high-class work this is not always a matter of paramount importance. The question of cost is generally regulated by the importance of the building. Of the two methods, it will often be found that work modelled *in situ* costs less than cast work.

In the first method, the work is modelled direct, and the cost thus minimised; whereas in the second method—cast work—the piece has not only to be modelled, but also to be moulded, cast, and fixed. In the examples given—as well as in the majority of works of this kind—the design has to be modelled in sections, and often some of these sections must again be cut into several pieces, each requiring to be separately moulded, cast, and fixed, thus enhancing the cost of the work by the cast process, which is, therefore, only the more economical for small work, or where there is a considerable amount of repeated work to be done. Ornamental work modelled *in situ* has one decisive advantage over cast work, inasmuch that it cannot be reproduced in inferior buildings, as is unfortunately too often done with cast work.

FORMING NICHS.—Niches are recesses formed in walls, sometimes for the purpose of placing some ornamental object in them, such as statues, vases, &c., and they are often constructed in thick walls in order to save materials. The plans or bases of niches are generally semicircular, but some partake of all the segments under a semicircle, while others are elliptical, and in a few instances they are square or rectangular. The elevations of niches are generally in accordance with their plans, but variations from this rule are sometimes met with. The crown or heads of niches are generally plain, but they are sometimes enriched with scalloped shells, &c., or panelled with mouldings. With respect to the proportion of niches there is no fixed rule, but the general one is twice and a half their width for their height. Various methods are employed in the formation of niches. The crowns of circular niches are generally run with a mould, because being circle on circle and small in surface, it is difficult to finish them true and smooth by hand.

The accompanying illustration No. 43 elucidates two methods of forming semicircular niches with the aid of running moulds. Fig. 1 shows the elevation, and Fig. 2 the section of the crown and a part of the body of niche, with the centre-boards and moulds in position when forming the crown of the niche. Fig. 4 shows the section of the body of the cove, with the mould in position when forming same. By the first method the niche is formed in two operations, and by the second method it is formed in one operation only. For the first method, cut a running mould to the section of the niche, as shown at B, Fig. 1, then fix it on the centre board, A, with two hinges, keeping the upper surface or mould plate level with the top edge of the centre-board, as shown on the section of the niche, Fig. 2. This also shows the end section of the centre-board and

the mould, with the mould plate and a hinge. The dotted line indicates the distance the mould travels. After this, fix the combined centre-board and mould on the wall, taking care that the top edge of the centre-board is level and exactly at the springing of the crown, C. The face of the wall must be floated plumb, and an allowance made by means of dots for the thickness of the setting coat before the centre-board is fixed. After the crown is finished, the centre-board and running mould is taken off the wall and separated. The mould is then horsed with two slippers to allow of its running the body or vertical part of the niche. The mould works on a running rule fixed on one

of two screeds which are formed on the face of the wall, one on each side of the opening. Care must be taken that the screeds are plumb with the centre-board dots. Fig. 3 shows an elevation of the mould when horsed. B is the mould, D is a connecting board on which the mould is fixed by means of the cleats C, C, and F, F are the slippers. Fig. 4 shows an end section of the horsed mould in position when running the body of the niche. The base is finished by hand.

By the second method the niche is run in one operation, as already mentioned. This is effected by cutting a running mould to the vertical section of the niche, then fixing a pivot at the bottom and a bolt at the top. A wood block, with a socket to fit the bolt on the mould, is let into the face of the wall at the top of the niche and temporarily fixed, then another block with a socket to fit the pivot of the mould is fixed at the bottom of the niche. Care must be taken that the sockets are plumb and in a line with the centre of the niche, also that they are in a line with the face of the wall, so as to allow the mould to form a true semicircle with perpendicular arrises. Place the pivot of the mould in the socket, and push the bolt up and secure it, and the mould is ready for working.

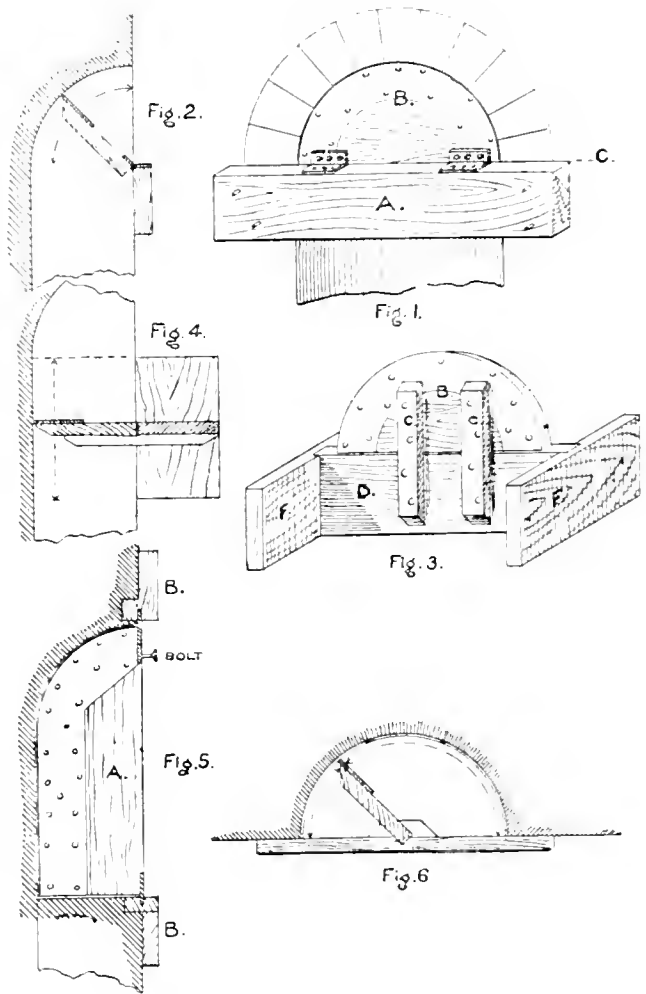

NO. 43.—FORMING NICHES WITH RUNNING MOULDS.

Fig. 5 shows a section of the niche with the mould in position. A is the mould with the pivot and bolt, and B, B, are the socket blocks. A plan of the niche and mould is shown at Fig. 6. This also shows the plan of the pivot block, and a board which is sometimes used to secure the block. The dotted line indicates the distance the mould travels. When there are splays or beads on the angle of the niche, the crown part is run with a radius-rod mould from a centre-board, and the vertical parts with a "twin-slipper running mould" on running rules fixed on the wall screeds, or with a nib running mould on a slipper and a nib running rule.

The vertical parts of the beads or splays may also be run with the mould shown in Fig. 5.

For this purpose two plates cut to the desired section must be fixed on the mould, one at each side. The crown part is run with a radius rod, as already mentioned. The crown surface and the angle moulding can also be run in one operation. This is effected by cutting a mould plate to the section of the moulding, including the section of the crown surface, then horsing it with a slipper to run on the wall surface, and a pivot to fit a socket formed in a centre-board, or with a radius-rod to work on a centre-board. A pivot will be found most suitable for small work, and a radius-rod for large work. In either case they must be fixed on the centre of the mould, so as to be in a line with the mould plate. After the crown is run, the mould plate of the crown surface is cut off, and the remaining part of the mould used for running the vertical mouldings.

In some designs a small moulding, such as an impost moulding, is carried round the body surface of the niche, and in a line with the springing of the crown. This moulding can be run in a similar way as shown at Fig. 5, or by fixing a flexible wood or a plaster running rule on the body of the niche for the mould to run on.

The crowns of niches that are panelled with small mouldings are best executed by making a model of the design, then moulding it, and casting and fixing as many as are required. In niche crowns that are enriched with shells, foliage, &c., the enrichment should be cast with the crown surface as a background. Fibrous plaster is well adapted for the construction of niches. For this purpose a reverse casting mould should be employed for forming the casts. This is made by cutting a reverse running mould to the section of the niche, and after a sufficient length of the body is run, cut the mould in half and run the crown. Then fix it on the end of the run body, and then fix rules at the sides and ends to form fences and rims, thus completing the casting mould.

Any of the above methods for forming niches with running moulds can be advantageously used for forming the body and crown of the Ionic niche, which is described and illustrated in Chapter VII.

CHAPTER VII.

EXTERIOR PLASTERING.

PORTLAND CEMENT FAÇADES—METHODS OF WORKING PORTLAND CEMENT FAÇADES—RUNNING PORTLAND CEMENT MOULDINGS—FINING—SAND FOR FINING—COLOURED CEMENT FAÇADES—PRESERVING PLASTERED FAÇADES—FIXING POINTS FOR METAL APPLIANCES—PEDIMENTS—PITCH OF PEDIMENTS—RAKING MOULDINGS—RAKING MODILLIONS—SETTING OUT AND PLASTERING DORIC PORCHES, IONIC NICHEs, PEDESTALS, OPEN PEDIMENTS, BLOCK CORNICE AND QUOINS, COLUMNS AND ARCHES, BALUSTRADES, PLAIN AND ORNAMENTAL BALUSTERS, PIERCED WORK, WINDOWS, WINDOW HEADS, DORMER WINDOWS, AND ELIZABETHAN GABLES—ROUGH CAST—SGRAFFITTO—FRESCO—INDIAN FRESCO AND MARBLE PLASTER—IMPRESSED PLASTER WORK.

PORTLAND CEMENT FAÇADES.—About half a century ago the exteriors of brick, and sometimes stone buildings, in many districts of the United Kingdom, especially in London, were plastered with Portland cement. The back and end elevations are more or less plain, while the fronts are of a more elaborate nature, representing stone work in all styles of architecture. These are still in existence and in good condition, which show the durability and adaptability of Portland cement when properly handled by competent plasterers. These fronts compare favourably with stone work of the same age, and it is a well-known fact that Portland cement wears better than Bath stone. Consequently it has been largely used for casing decayed stone fronts as well as brick work. There are miles of streets in the West End of London where nearly the whole of the façades are either plastered with Roman or Portland cement. Roman and other cements were in general use about a century ago for plastered fronts. Regent Street and numerous terraces around Regent's Park, designed by Nash, had plastered façades. Fine examples of Roman cement façades are to be seen in Chester Terrace and Gloucester Terrace, Regent's Park. Some of these façades are enriched with massive fluted columns. Iron fluted collars, one for the base, one for the middle, and one for the top of the column, were temporarily fixed on the brick core as guides for ruling in the columns and flutes. This work was done by H. Mott, the grandfather of the present H. Mott, Clerk to the Worshipful Company of Plasterers. The foreman was S. Wright. Owing to the unequal manufacture of Roman cement, some of the work executed with it, after a few years' exposure, showed signs of decay, which brought the use of cement for plastered fronts into evil repute. On the introduction of Portland cement, plastered fronts again became fashionable, and the use of Roman cement, except for inferior class of work, was abandoned. In a few instances Portland cement scaled in parts, but this was due to the unequal quality of early manufacture, and also owing to the inexperience of some workmen of the then new material. At present the manufacture is far more equal and reliable. This fact, combined with the greater all-round knowledge and experience in the manipulation, causes Portland cement work for façades to be safe, strong, sharp, and durable.

Among the many fine examples of Portland cement façades in London, the following may be noticed :—

Alexandra Hotel, near Hyde Park Corner. Here it can be seen in all forms, as figures, foliage,

vermiculated work, and other features generally reserved for stone work. This beautiful façade rivals most kinds of stone in colour, and shows no sign of flaw or crack. T. Bass was the master plasterer, W. Hawkins the scaffold foreman, and W. Hatt was the shop foreman on this unrivalled work. The offices of the old Metropolitan Board of Works, Spring Gardens, is a striking example of Portland cement fronts. C. Lane was the foreman plasterer.

Another excellent example of Portland cement façades is to be seen at Campbell's Observatory, in the King's Road, Chelsea. This work is remarkable for its uniform colour and texture. This exquisite example of Portland cement work was executed by Messrs Parsons, a high-class firm of plasterers, now defunct. G. Searle was the foreman plasterer, and the modelling was executed by R. Hanwell and the author. Some of the adjoining shops, although not so fine in the manipulation of the cement work, contain some effective modelling by W. Doyle. The façades of the houses at Lancaster Gate are plastered with Portland and Sheppey cements, Sheppey being used for the mouldings and cast work, and Portland cement for the walls and plain work. John Helm was the foreman plasterer.

An admirable example of a Portland cement façade is to be seen at the United Service Club in Pall Mall, with its rich frieze in the main cornice, also the pediment and fluted columns. This effective modelling is by T. Garland, J. Main being the foreman plasterer. The Athenæum Club is another example of the utility of Portland cement, a prominent feature being its handsome cornice and equestrian frieze. This work was carried out under the supervision of J. Parish, a London plasterer. Another example is the Travellers' Club, designed by Charles Barry. The modelling was done by T. Garland, T. Sidwell being the foreman plasterer. This work is not up to the standard of that in the above-named clubs, which may be accounted for by the fact that the work was carried out by the builder, while the others were carried out by master plasterers. Many stone fronts in the same district and of more recent date than the above-mentioned examples of Portland cement fronts already show signs of decay and lamination.

A highly interesting and curious combination of stone, brick, and cement work is to be seen in the façade and ends of the Grosvenor Hotel, London. The greater part of the mouldings and ornamentation on the exterior of this noble building is composed of Portland cement and Sheppey cement in the proportion of 1 part of the latter to 3 parts of the former. The Sheppey was used to accelerate the setting of the Portland cement. One part of this cement mixture was gauged with 3 parts of very coarse sand and small shingle. The whole of the enrichments for the exterior, and the plaster decorations for the interior, were modelled by T. Garland, and G. Dickens and J. Wheeler were the foreman plasterers for the exterior and interior work, the whole being done under the supervision of "Nobby" Rodeford, a notorious London plasterer. So close is the resemblance of the cement work to the stone, that only the closest scrutiny will detect the difference in grain and colour. It is difficult, even for an expert, standing in the street and looking up at the façade, to point out which is stone work and which cement. It will be interesting and instructive in the future to note the properties as to colour and wear, and observe the effects of the London atmosphere on the three materials, stone, brick, and cement, with which the exterior of this edifice is constructed and decorated.

Unusual opportunities are to be found in Victoria Street, Westminster, London, for comparing the wearing properties of plastered Portland cement and cast concrete with that of stone, brick, and terra-cotta. Besides the façades wholly cement-fronted, there are other buildings where the structural brick work is faced in some parts—such as the main cornice, window, and door mouldings, &c. with Portland cement, while in others stone forms a part of the façades. These cement-fronted

buildings in Victoria Street testify to the adaptability and durability of Portland cement, and compare favourably as regards colour and wear with adjoining stone buildings. These cement fronts contain some fine examples of T. Garland's modelling.

The Westminster Palace Hotel, erected in 1860, where, after completing the decorative models, I made my maiden effort in the manipulation of cement work under the guidance of J. Towser, is a fair example of Portland cement façades. J. Silvester was the foreman plasterer. Excellent examples of Portland cement façades are to be seen in the additions to the Euston and Paddington railway stations. These works were executed about two decades ago by Joseph Bickley, one of the few master plasterers in London. Victoria Street also contains a range of buildings, a great portion of which is constructed with cast Portland cement concrete of a Mansfield stone colour. This work was executed in 1883 by W. H. Lascelles, and the exquisite modelling by P. Thomas and J. Humphreys. Another example for future comparison as to the relative merits of wear and durability of cast concrete and terra-cotta is to be found in the three top bay windows of the Joint-Stock Bank, Victoria Street, where a part of the main cornice, baluster, base, rail, and string mouldings used in a recent addition are composed of cast concrete coloured to imitate the terra-cotta which forms the dressings of the original edifice. The concrete casts can be distinguished from the terra-cotta, the former being double the length of the latter. This work was executed in 1890, by J. G. Smyth, under the author's supervision.

On a few of the old Portland cement fronts here mentioned there are several small portions where the fining has scaled. This is due to the work being done in hot weather without properly saturating the surface; also to the floating being too smooth and dry. These surface defects can be repaired, leaving a strong and solid body. Stone or brick which laminates can only be repaired by cutting out the entire block or brick. The rapidity with which Portland cement can be repaired, and its ultimate strength, is a decided advantage in its favour for façades. Although stone and red brick fronts are now the fashion, the utility of Portland cement must again be recognised by the architect, both for new fronts and encasing old stone and brick work. It is certainly more damp-resisting than either stone or brick, and it can be coloured to any desired tint, or enriched by carved cement work as well as cast, thus avoiding repetition. Plain surfaces may also be decorated both in line and colour with sgraffitto, and with coloured stone flints, glass, &c., as used in depeter. Portland cement has no rival positively as a structural material for most building purposes. It is unrivalled for external plastering. Its strength, tenacity, and adhesive power give support to a wall, instead of a dead weight having to be carried. It is absolutely the best material for resisting vermin, damp, and fire. In fact, of all mortars or cements that have been used for plastering the exterior wall surfaces of buildings, Portland cement is unquestionably the best plaster material for this purpose produced in this century or any other. No other material, whether used monolithically or as a casing for stone or brick work, will resist the action of our variable climate like Portland cement. Objections have been raised against its cold colour, but this is simply the colour of the natural stone from which it takes its name, and the objections may be overcome by colouring it as already mentioned. Even when begrimed by age, it is superior in point of endurance and damp resistance to porous stone. It certainly looks better and more pleasing than a brick façade with a network of unsightly joints, and Portland cement façades, when dirty, can be cleaned and coloured at a less cost than stone, or repointing brick fronts. In case these comparisons should convey the impression that I put forward Portland cement work as a substitute to be preferred generally to stone or bricks as a finish for façades, it is perhaps necessary to say that I disclaim any such intention, and to explain that what is claimed for it, and can well be demonstrated, is that in all cases where stone

is soft, or bricks inferior, it would be wise economy to exhaust the possibilities of Portland cement with and without colour, before using unsuitable stone or bricks. Having regard to the increasing scarcity of good stone, it is safe to predict an extended use in the future for Portland cement façades.

METHODS OF WORKING PORTLAND CEMENT FAÇADES.—Considerable conflict of opinion prevails as to the best method of using Portland cement in the formation of mouldings and plain surfaces on the façades of buildings. The directions here given are based on experience and successful practice, not only of my own, but also of others who are leading lights in plastic arts, and who have made the subject a life-long study. The first and original process is by the use of permanent screeds, that is, the screeds for plumbing and running purposes constitute a part of the floating. This process is the most general in use. The second process is by the use of temporary screeds formed with plaster. This method is one which I have introduced with considerable success. It has been termed the "plaster screed process," to distinguish it from the first mentioned, which is termed the "permanent screed process," and is performed as follows:—

PERMANENT SCREED PROCESS.—The first necessity for all Portland cement work is good cement, which should be tested and air-slaked, as described for Portland cement in the chapters on "Materials." As many tons should be ordered as floor-room can be found for or the approximate requirements of the job demand. Only use clean sharp river sand where it can be obtained, and clean shingle passed through a $\frac{1}{4}$ -inch sieve or screen, mixed in the proportion of 1 part of shingle to 3 of sand. The above are the requisite materials for roughing out or floating. Crushed shingle is better than the round pea shingle. Crushed stone or granite is even better than shingle, but stone being of a more porous nature, it must be thoroughly wetted before using. Limestone or other hard stone is best for this purpose. The materials should be accurately measured with a bottomless box, in the proportion of 5 parts of mixed shingle and sand to 2 of cement. Turn the whole over twice in a dry state with a shovel, and thrice after the water is added. Special care must be taken not to put in too much water, or the result will be a too soft gauge, and therefore more cement and sand will have to be added to make it of the proper consistency. This should be like well-tempered "coarse stuff." The whole of the front should be cleared of all building mortar, and the surface well swept with a coarse broom, and then thoroughly wetted until the absorption of the brick work is completely stopped. Cement adheres and eventually becomes much harder when laid on a damp surface than if laid on a dry or porous one. Hence the importance of careful and thorough wetting. The joints of new brick work, or where there is a suspicion of unslaked lime particles in the joints, should be raked out and then swept and wetted.

Large surfaces of smooth stone work should be hacked to give a key for the cement. After the wall surface is cleaned, the front of the building must be plumbed. This is done in a similar way to that described for lime plastering in Chapter IV., but with the following additions:—The two ends of the building are plumbed first. A plasterer at top of one end lets down a line long enough to reach from top to bottom of the building, with a heavy plumb-bob at one end of it, to a plasterer at the bottom. Each man must have a wooden gauge of exactly the same length, and long enough to clear all projections. The top man drives a strong nail into a brick joint, allowing the head to project about $\frac{3}{4}$ inch, and places the gauge with the line on the head of the nail. The man at the bottom drives in a nail, then steadies the plumb-bob with one hand, while he applies the gauge with the other hand on the head of this nail. This bottom nail must be driven in just so far that the steady line will strike the bottom gauge exactly on the same place as it is suspended from the top one. If there are no projections at this particular spot, the top man may fasten his end of the line on the head of his nail, and the bottom man will do the same, and then

the intermediate nails can be driven in exactly to the line from top to bottom of the building. The intermediate nails consist of one nail at the top and one at the bottom of each story. If there are projections which prevent the line being used in that way, a third man is required to assist with a gauge of the same size as the other two; and while the top and bottom men hold their gauges on the heads of their respective nails, the third man knocks in the intermediate nails exactly to his gauge from the line. All nails must be kept about 1 foot away from the projections, to allow free play for the floating rule when forming the screeds. The same operation is repeated at the other end of the building, which gives two vertical lines, from which all other lines are formed. Horizontal lines at the top and bottom of each story are next formed. If there are no projections to interfere with the free course of the line from end to end of the building, the line can be fastened to the heads of the end nails, and then the intermediate nails knocked into the line, about 9 feet apart. If there are projections, the men will have to adopt the same method as before described. These lines of nails give the positions and bearings for the screeds, which form the groundwork of a perfectly upright and straight front. Whether it is altogether plain, or is embellished with ornament or mouldings, this method of planning out is equally necessary.

Before laying the screeds, it may be desirable to thoroughly wet the surface again, especially if the weather is warm, or sun rays fall on the work. The screeds should be narrow, not wider than the thickness of the floating rule. After they are laid, do not be in too great a hurry to follow on with the rule, or the screeds will shrink; but when the stuff is somewhat firm rub the rule gently down on to the head of the nails, thus leaving a firm screed, not liable to shrink. Where practicable, the whole of the screeds should be laid first, as sometimes the nails get accidentally knocked out of place. This method also gives more time for the screeds to get firm before being ruled off. When the screeds are hard enough to bear the floating rule, begin and lay the whole of the front, and rule the surface in with a floating rule. The floating rules must be made sufficiently long to reach from screed to screed. If there are any deep parts on the surface, it is not advisable to fill them in all at once, but rough them out first, and when firm or nearly set, follow on with the floating. The floating stuff should be applied as quickly as possible, and with little manipulation, and then the floating rule worked with an up and down slanting motion, so as to cut off any excess stuff, and leave a rough surface. The rougher the finish of the floating, and the less labour applied to it, the better; the process of setting is less disturbed, and a stronger key is obtained for the fining coat. On the roughness of the floated surface depends the success or failure of the work. The adhesive power of Portland cement is great when used neat, but of course the adhesion is decreased by the addition of sand. It is therefore necessary to obtain the best possible key for the fining coat. The key left by the rule on the floating surface may be supplemented by means of a nail float, or by a large nail, which is worked in a circular motion over the surface, or still better, by the use of a sharp, wide-toothed drag.

RUNNING PORTLAND CEMENT MOULDINGS.—When the floating is completed, the mouldings are run. The nib of the running mould for the main cornice should not project more than 1 inch on the weathering. A line, parallel with the drip, or most prominent upright member, should be formed with a saw on the stock to act as an indicator when plumbing the mould with the plumb-bob, as shown in the annexed illustration (No. 44). This shows a section of the mould, wall and nib running rules, stone bracket, and blocking over the main cornice. In all mouldings of this class there are two kinds of running rules required—one for the slipper of the mould, called the “slipper” or wall rule, as shown at W, which is fixed on the wall screed F; and one for the nib, called the “nib-rule,” as shown at N.

The slipper rule should not be less than $2\frac{1}{2}$ inches wide and $\frac{1}{2}$ inch thick, and there is nothing better than straight flooring boards for the nib-rules. Proceed to fix the running rules by first placing the mould on the brick core at one end of the building, and make a mark on the wall at the bottom of the slipper. This mark indicates the line of the wall rule, and ought to be levelled from one end to the other end of the building, but the usual way is to follow the courses of the brick work, though this method is not always reliable, as the brick work often varies in line. Having made a mark at one end of the building, proceed to the other end, and make a similar mark. Then strike a chalk line from those marks from end to end of the building. In striking this line a man must be at each end of the line, and another at the middle, who, when the line is fully stretched, moves it a little up out of the straight before the line is struck. This is to allow for the deflection of the line which is usual in a long stretch, also to give a slight

camber to the moulding, which causes it to have the appearance when finished and viewed from the street of being perfectly straight. After this nail the running rules up to this chalk line, taking care to allow them to sufficiently project at both ends of the building to carry the mould the required length for the returns.

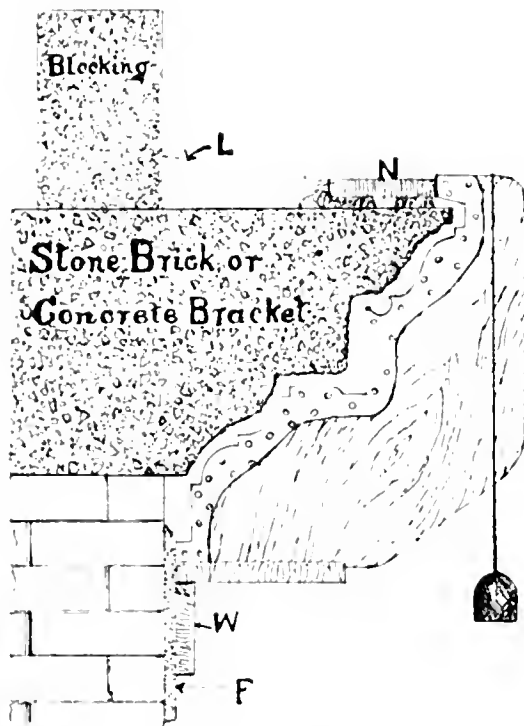

NO. 44.—PLUMBING RUNNING MOLDS.

The next part of the process is to form a running screed with neat cement at the top of the wall rule. This screed must not be more than $1\frac{1}{2}$ inches wide and $\frac{1}{4}$ inch thick, and is cut off when the moulding is run. When the screed is firm, proceed to fix the nib-rules. First place the mould on the wall rule at one end of the building, and hold it so that the plumb-bob-line will be in unison with the plumb-line on the stock of the mould. While in this position another man draws the nib-rules forward until close up to the nib of the mould. The rule is bedded on gauged dots and weighted down with bricks to keep it in position. The same operation is done at the other end of the building. Then stretch a line from end to end to act as a

guide for fixing the intermediate rules, which are required to make up the whole length of the moulding. The nib-rules are further secured by laying dabs of cement where necessary. The stuff for roughing out mouldings is composed of the same materials and proportions as used for the wall floating, gauged stiff, yet of a plastic consistency. Never use soft stuff on a moulding until completely filled out. In laying stuff on a moulding of any kind, never allow a smooth surface to set before the next coat is laid. By the action of the trowel it is impossible to avoid smooth parts, but where the stuff begins to set the surface should be roughed with a pointed lath or a long nail. The point of a trowel is generally used for this purpose, but this is a mistake, as the sunk line formed by a trowel is smooth on one side, and is too thin at bottom to afford a strong key for the next coat. The nail or lath should be drawn up diagonally, as this way is not so apt to drag the stuff down or off the moulding as if drawn downwards. After laying on the coarse gauge for two

or three hours, according to the size of the moulding, the members of the moulding will begin to assume form, then cease using the coarse gauge and allow the work to firm for about one hour. After this use fine stuff to complete the roughing out. This stuff is composed of fine washed river sand and cement, gauged in the ratio of 5 parts of sand to 2 of cement. Continue with this fine stuff until the moulding is completely filled out, and let it rest for a couple of hours, or until the surface sets a little. Then make up some "dryers" with 5 parts of river sand mixed dry with 2 parts of cement, and when thoroughly mixed put it into a sack ready for use. Now gauge up as much soft fine stuff as will cover the whole surface. This soft fine stuff is gauged in the same ratio as above, but is made much softer. It is laid very thin all over the moulding without missing a spot. The running mould is then gently run over from end to end, pressing steadily, yet lightly. This done, let every man on the scaffold put a portion of the dryers in his apron, and quickly throw it on to the wet moulding until it is completely covered, and then clean the rules so that the mould will have a free passage. If it is a large mould, it is desirable that two men should push it in the final run, as it requires to be pressed hard to the rules. It may perhaps require one more run over, but without any stuff being laid, and then the moulding is finished straight and strong, of uniform texture and colour, and with an eventual solidity that storms and tempests may lash in vain.

When running mouldings in Portland cement, attention must be paid to all mitres and returns, so that they may be brought out at the same time as the moulding is being run. Mitres and returns are worked by hand, so sufficient stuff must be laid on, in order that they may be worked down with drags and chisels in a similar way to a mason working stone. The mitres are finished with the same kind of materials as used for the moulding, which will ensure the same colour when dry, so that no joints will be shown. The next thing to be done is to take the rules down, cut the running screed off, and clear the weathering of all loose stuff down to the brick work. Then dust it from end to end with a dry brush and wet it slightly, taking care that no water runs down the surface of the moulding. After this gauge as much $\frac{1}{4}$ -inch shingle and cement—in the ratio of 2 parts of shingle to 1 of cement—as will cover the entire length of moulding. Lay this rough stuff, and then rule it fair with a long floating rule, taking care to allow a fall from $1\frac{1}{2}$ inches to 3 inches, according to the projection of the moulding, as indicated by the dotted line at L on illustration No. 44. When this stuff is firm, it is laid over with a thin coat of fine stuff, gauged in the ratio of 2 parts of washed sand to 1 of cement. This weathering surface is finished with the trowel, to get a close, smooth, and impervious surface, to allow rain to run off freely, and to resist the effects of rain and snow. Mouldings are sometimes required to be finished with a fine smooth surface. This is effected by using a finely sifted Portland cement for the finishing coat. All mouldings of every description should be begun and finished in the same manner as described above. Where practical, it is advisable to finish the whole of the mouldings in one section or scaffold level before starting to finish the plain surfaces. Short window heads, if circular or pedimental in form, may also be cast and planted. It is usual to build a brick or stone core for heavy mouldings over doors and windows. In this case the moulding must be run and mitred as already described.

FIXING.—Finishing or finishing plain surfaces on the façade of a building is a criterion of the plasterer's ability in the manipulation of Portland cement. Uniformity of colour is imperative. This is obtained by uniformity of gauging, also manipulation of the materials. No joints should be shown. The smoothness is to be attained by beginning and finishing the given space in one operation. If the scaffold should interfere with the work being done in this way, it must be altered, and as many men put on to the given space as can conveniently work on it, and thus

avoid making a joint where it ought not to be. For instance, the blocking over the main cornice should be done first, then the top story between the main cornice and the first string course, and so on down to the bottom. Well-washed sharp river sand is required for the fining coat. The whole of the sand required for the front should be washed and spread out to dry some weeks before it is wanted, and frequently turned over till it becomes nearly as dry as the cement. When dry, add to it by measure one-fourth of dry silver sand. Well mix the two together, then proceed to measure out as much washed sand and cement as will finish the proposed given space in the proportion of 5 parts of sand to 2 of cement. After mixing these materials, run it through a fine sieve, and it will be ready for use. The admixture of silver sand forms a fine white stone-like colour, and a close-grained and even-textured surface.

All splashes and bits of projecting cement must be cleared off the floating surface with a trowel. The whole surface must then be thoroughly wetted with clean water. On this wetting depends the ultimate adhesion, also the uniform working and strength of the fining coat. If the moisture, or blood of the cement, is absorbed by the suction of the wall, the cement will become inert, and the stuff will eventually peel or scale. The water must be thrown on wholesale until all absorption is stopped for the time being, and the floating will absorb no more. As a test that the floating is sufficiently saturated, a moist glaze will appear, and remain for some time. When that glaze begins to clear off, start at once and lay on the fining stuff, which has been previously gauged and delivered on the scaffold. This stuff must not be gauged too soft, rather stiffish than otherwise. As much should be gauged at once as will cover the given wetted space. One plasterer lays the stuff about $\frac{3}{16}$ inch thick, and another follows with the traversing rule, working it carefully in all directions until the surface is full and straight. After the work begins to stiffen, the surface is gently scoured with a cross-grained hand-float until the moisture has disappeared from the surface. The next object is to get rid of the hand-float marks, and transform the surface into a close stone-like face of even texture. This is obtained by "patting," that is, gently beating the surface with the full face of the hand-float, which has the effect of pressing all the particles of the sand into the surface of the work, and effacing all marks of every kind. In patting the surface portions of sand will accumulate on the face of the float. This must be constantly wiped off with a damp brush, as a thoroughly clean float is necessary for the proper execution of this class of work. It must be understood that no water is to be thrown on after the fining stuff is laid. If the floated surface has been uniformly and thoroughly saturated, no water will be required for scouring, but if a dry spot should appear here or there, then damp the face of the float with a wet brush, and work the dry spot until it is equal in dampness with the other work. Large spaces should be commenced early in the morning, to give sufficient time to keep the work going, as every space should be finished the same day as begun.

SAND FOR FINING.—In order to obtain a smooth, even-grained, and uniform surface, the sand for the fining should be well washed through a fine sieve. The thinner the coat of fining the finer the sand should be, so as to allow sufficient space between the wall surface and the finished surface for the grains of sand. It is obvious that if the sand grains are equal in size to the thickness of the fining, there is little possibility of consolidating and forming a fair surface by "patting"; but if the sand grains are smaller than the thickness of the fining, an allowance is obtained for patting the surface, so as to get it compact and uniform. Although the sand is fine, it should not be flat or round, but sharp and angular, otherwise it loses its powers of keying and bonding, which are so necessary in this as in all plaster and concrete work. Portland cement façades are simply a form of fine concrete, and fining may be described as concrete in its smallest degree or scale. The

fineness or gauge of the sieve for washing the sand must be regulated according to the required degree of fineness or size of the sand.

TROWELLED PORTLAND CEMENT.—It is often required that Portland cement should have a fine smooth surface. This is obtained by using a finer material for the fining coat, and then scouring, trowelling, and brushing the surface in a similar way as described for working Parian cement. The materials consist of Portland cement, sand, and lime, in the proportion of 2 parts of cement and 1 of sand, and 1 part of fine lime putty, and the whole thoroughly incorporated together. By using silver sand a white lustrous surface is obtained. Portland cement that works short under the trowel may be corrected by adding 1 part of old lime putty to each 5 parts of Portland cement. The lime renders the stuff fat, plastic, and easy to work, without decreasing its impermeability. This "limed cement" may be safely used where an extra fine smooth finish is desirable.

PLASTER SCREED PROCESS.—A novel method for executing Portland cement fronts is by the use of plaster or "skeleton screeds." This method may be employed with advantage during excessively hot weather, or where there is an unusually strong suction. It enables the work to be done in one operation. By this continuous process the fining coat can be laid as soon as the floating coat is "green" that is, when a coat is set or firm, but not dry. This is an important factor in the perfect cohesion of the two coats, and free natural working of the material and uniformity of texture and colour, with the best results at the least cost. Skeleton screeds are simply temporary screeds for plumbing, levelling, floating, and running mouldings. They are formed with plaster, so that they can be used straight away, instead of having to wait two or three hours to set (as is sometimes the case with Portland cement).

The plaster being cut out when the screeds are done with, and the spaces filled up with the same kind of materials as used for the floating, allows the work to dry uniformly. They should be narrow, not more than $1\frac{1}{2}$ inches wide for floating and 2 inches for running screeds, and are best made as described for "pressed screeds." After the plaster is pressed under the edge of the rule, the superfluous stuff at each side of the rule should be cut square by drawing a trowel along each side of the rule, cutting the plaster right down to the brick.

A square edge makes a better joint, and the screed is more easily cut off when done with. The upper edge of the running screeds must be cut in a line with the bottom member of the moulding cornice. In some instances it may be necessary to make the running mould so that it will form a bearing about 1 inch deep on the wall surface. All mouldings are run first, and then the running screeds (unless required for floating) are cut off. The floating is then proceeded with, but only as much should be laid as can be finished the same or following day, and in one operation. As soon as one bay of the section is floated, the skeleton screeds are cut out and the space made good, so that the whole surface can be finished at the same time. With the exception of the screeds, and running the mouldings first, all the other work is done as described for the permanent screed process.

COLOURED FAÇADES.—Portland cement fronts may be further decorated by the use of various coloured parts. Various colours can be imparted to the finished surface by mixing the metallic oxides with the cement. The admixture of silver sand to cement yields a semblance to fine white stone. Crushed spar, glass, granite, &c., used as aggregates for the final coat, impart a lustrous appearance to the finished surface. The linear ornamentation and the various tinted strata of sgraffitto may be artistically employed for relieving plain surfaces in Portland cement façades. Pleasing effects may be obtained by using natural coloured sands of different tints for gauging

with cement for the final coat. Some years ago I saw a house front at Duns, N.B., executed by W. Smith, treated in the following manner. The façade was set out with lines to represent ashlar stone work. The stones were varied in colour alternately by using a rich yellow pit sand from Gilmerton for some, and a grey river sand for others. Red sand and brick-dust is used for a similar purpose, also for colouring cast concrete. Bullocks' blood mixed with cement has been used to obtain a resemblance to red brick. Earthy stains are not so durable as mineral oxides, they also tend to weaken the cement, whereas mineral oxides have a reverse tendency. Manganese, or manganite, is also of a suitable nature. The colouring matters mentioned for sgraffitto may also be used for façades, mouldings, and castings. For a Caen stone colour, 4 parts by weight of yellow oxide, $\frac{1}{2}$ part of red oxide, and 36 parts of cement; for dark red colour, 10 parts of red oxide to 36 parts of cement; and for a buff stone, 8 parts of yellow oxide, 1 part of red oxide, to 36 parts of cement. These proportions vary according to the strength and quality of the oxides. Bright effects are obtained by using crushed white or bright-coloured glass as a substitute for sand. The colour of cast work, if mixed with the plastic materials when casting will last as long as the cast. Coloured cement or stucco will last as long as the work, whereas if they were coloured on the surface only, the colour would soon wear off.

PRESERVING PLASTERED FAÇADES.—To obtain durable work and guard against defects in the form of laminations, water-cracks, discolorations, and vegetable or other growths on cement façades, the materials must be carefully selected and manipulated. The work should also be painted at intervals. This may be done with oil-paint, distemper, cement-wash, or with some of the other compounds given in the "recipes." The primary cause of the premature decay which sometimes takes place in stuccos and cements when used externally on façades or walls is the presence of muddy earth and decayed animal and vegetable matter in the sand used with the lime and cement. To this may be added frequent impurities in the limes and cements themselves, particularly of argillaceous matter in the former, and sometimes to the too great proportions of sand to lime or cement. These things might, however, remain quiescent for a long time if the work were well protected from access of moisture, which is the great exciting cause. The paint, distemper, or cement-wash on the surface is generally sufficient to prevent the rain which may beat against a vertical face from penetrating, especially if the work has been well hand-floated and trowelled, to make it close and compact; but the evil arises from exposure above, and from the numberless horizontal unfloat surfaces which are constantly presented. These receive and collect the water, and convey in streams over the vertical surfaces what is not immediately absorbed, and the work thus becoming saturated, frost seizes and bursts it, or warmth calls the vegetative powers of the impurities in it into action, and the whole is covered with a green sward. Let the sand of which a plaster composition is to be formed, whether with lime or cement, be washed until it no longer discolours clean water, and be well compounded with cementitious matter free from the impurities with which it is so frequently charged; let the work be well hand-floated and trowelled, particularly on the backs or upper horizontal surfaces of projections, and protected above by projecting eaves, or otherwise, and with common care and attention to paint, distemper, or cement-wash at intervals, it will last as long as anything of the kind can be expected, or is found to last anywhere. Painting the surface with oil-paint, distemper, or cement-wash at intervals also makes the work look bright and cheerful.

FIXING POINTS FOR METAL APPLIANCES.—In façades finished with Portland or other hydraulic cement, care must be exercised to provide wood plugs, or the brick joints marked on the surface, as fixing points for metal signs, pipes, brackets, water pipes, rain-water heads, or similar

appliances which are frequently fixed on exteriors. The positions and size of these metal appliances should be ascertained, and the necessary plugs inserted in the brick work, before the fining is commenced. Nothing looks so unsightly or distressing to the eye as patches on a newly plastered surface. Fixing points or orifices for fixing metal weathercocks, vanes, or finials or similar terminations to turrets, spires, or apexes, should also be formed before the fining is commenced. Excellent examples of rain-water heads, vanes, and finials, designed by some of our leading architects, and manufactured by Mr T. Elsley, are shown in the advertisement pages. These well-designed examples will serve to show their use, application, and mode of fixing. By adopting this method of first forming fixing points and then fining the surface, the metal appliances can be readily fixed and without fear of injuring the wall surface. It also enables the metal appliances to be freely unfixd for cleaning or repairing purposes. Small or light rain-water heads can be securely fixed by inserting nails into the joints of the brick work. In this case the positions of the joints should be indicated on the fining coat, by means of chalk or pencil marks, as guides for fixing. This gives a secure fixing, and avoids seeking for the joints, and saves unnecessary breakage of the finished surface.

Examples of some of the principal parts of façades are now given to further assist the plasterer in the working of Portland cement façades. They will also be of service for interior works in lime and white cement plastering, and also for fibrous plaster work.

PEDIMENTS.—Pediment—in French *Fronton*; from the Latin *Frons*, the forehead—is the triangular ornament that sometimes crowns the front of a building, or of a door, window, or niche. Pediments are, however, sometimes in the form of the segment of a circle, when applied to doors and windows. A pediment consists of a horizontal cornice, supporting or enclosing a triangular or curvilinear space, either plain or enriched, called the tympanum or tympan, which is covered either with two portions of straight inclined cornice (generally termed a pitched pediment), or with one curvilinear cornice (sometimes termed a compass pediment), following the direction of its upper outline. Tympani are often decorated with shields, male and female figures, foliage, and flowers. Besides the triangular and circular pediments, they are sometimes composed of both these forms, some of an undulating figure, some semi-hexagonal, some with the inclined cornice and tympan open in the middle to receive a bust or other enrichment, and others where the aperture is left void, and the two ends of the inclined cornice are finished with a couple of volutes or with returned ends.

The face of the tympanum is always placed on a line perpendicular with the frieze. The two uppermost members of the cornice are always omitted in the horizontal one of a pediment, that part of the profile being directed upwards to finish the inclined cornices. When the cornices are ornamented with modillions, dentils, &c., the ornaments of the inclined cornices should be perpendicular over those of the horizontal cornice, and their sides be perpendicular to the horizon.

The formation of large pediments on façades in Portland cement requires accurate setting out to avoid errors and subsequent alterations. Two running moulds, one for the inclined or raking cornice, and one for the horizontal cornice, are required. The cornices are run on a wall running rule and a nib running rule, and after the mitres and returns are "put in," the weathering or flat upper surface is laid and finished fair and smooth. For extra large pediments the inclined moulding is run in two sections, using the soffit of the moulding as a screed. This part is finished by hand after the moulding is run.

For small pediments over windows and doors the horizontal cornice is run first, and then the inclined cornices are formed by fixing a plaster mould on the horizontal cornice and against the

wall. This mould is then filled in with fine concrete, and as soon as it is set the mould is withdrawn and the mouldings fined off. The tympani are then fined off, or filled in with an enrichment, as the case may be.

The plaster mould for the inclined cornices can be so constructed that the two inclined cornices, with the two returns and the apex mitre, are all formed in one operation. The upper or weathering part is left open to allow the fine concrete to be run in. The casting mould is best formed with a reverse running mould. A casting mould constructed with fibrous plaster may also be advantageously used for forming the triangular or circular parts of pediments. Being of a more yielding nature than solid plaster, the fibrous mould can be "sprung" and taken off more freely, and with less risk of its breaking and also damaging the work. Whole pediments may be formed in one operation by the use of plaster moulds fixed *in situ*, and then filled in with fine concrete and finished off by hand. Stone, brick, or rough concrete courses should be built in the walls to act as brackets for the cornices. In the absence of cores or brackets, chases must be cut in the wall, to allow the fine concrete to bond into the wall, to form a support for the cornices. The method of making a reverse casting mould for pediments is demonstrated in Chapter XIII.

PITCH OF PEDIMENTS.—There are three different rules or proportions for determining the pitch of pediments. These are two-ninths, one-fifth, or one-fourth of the whole extent, the first of which is shown in the annexed illustration (No. 45), which is self-explanatory.

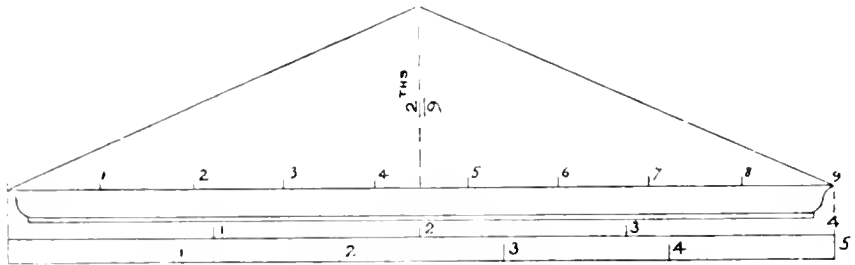

No. 45.—PITCH OF PEDIMENTS.

RAKING MOULDINGS.—The chief difficulty in the working of pediments is to set out the profile of the raking cornice so that it will intersect or mitre accurately with the horizontal part, and in the case of an open pediment, where the raking or pitched cornice is returned at the upper end, that the fillet or other vertical members of the cornice will be perpendicular. The method of setting out these mouldings are as follows. The method of setting out the raking profile of various members is elucidated in the annexed illustration No. 46. In all the figures, A is the profile of the horizontal member, B the raking profile of the inclined moulding, and C the raking profile of the returned end of an open pediment.

TO DESCRIBE THE RAKING PROFILES OF A CYMA-RECTA.—Take A, Fig. 1, as the given cyma-recta of the horizontal cornice, the bed of which extends from *c* to *b*, and from *b* to *g*, and the profile or horizontal section from *c* to *g*. To describe the raking cyma-recta, first divide this profile into four equal parts as *d*, *e*, *f*, and from these points draw the horizontal lines *i f*, *k e*, and *q d*; then from the same points *d*, *e*, *f*, draw parallel raking lines, as from *f* to 1, *e* to 2, and *d* to 3, according to the desired pitch of pediment. Again, from the points *d*, *e*, *f*, draw the perpendicular lines *d k*, *e l*, and *f m*. This done, draw in any part, as *n o*, at B, a right line at right angles to the raking lines; then make the horizontal lines *q w*, *r n*, and *s t*, equal in length to the lines *i f*, *k e*, and *q d* in A; and then on the lower line of the fillet as *p o*, set out the

points for the lines m, l, k , making them equidistant to the lines m, l, k in A , and from these points draw lines parallel to no till they cut the raking lines in the points q, r, s , and then through the points p, q, r , trace the upper curve of the cyma-recta, and through the points r, s, n , trace the lower curve, thus forming the required raking cyma-recta. The curves may also be described with a compass by finding the centres to describe the arc of a circle to pass through the three points p, q, r , and r, s, n .

TO DESCRIBE THE PROFILE OF A RETURNED CORNICE.—The following method can be

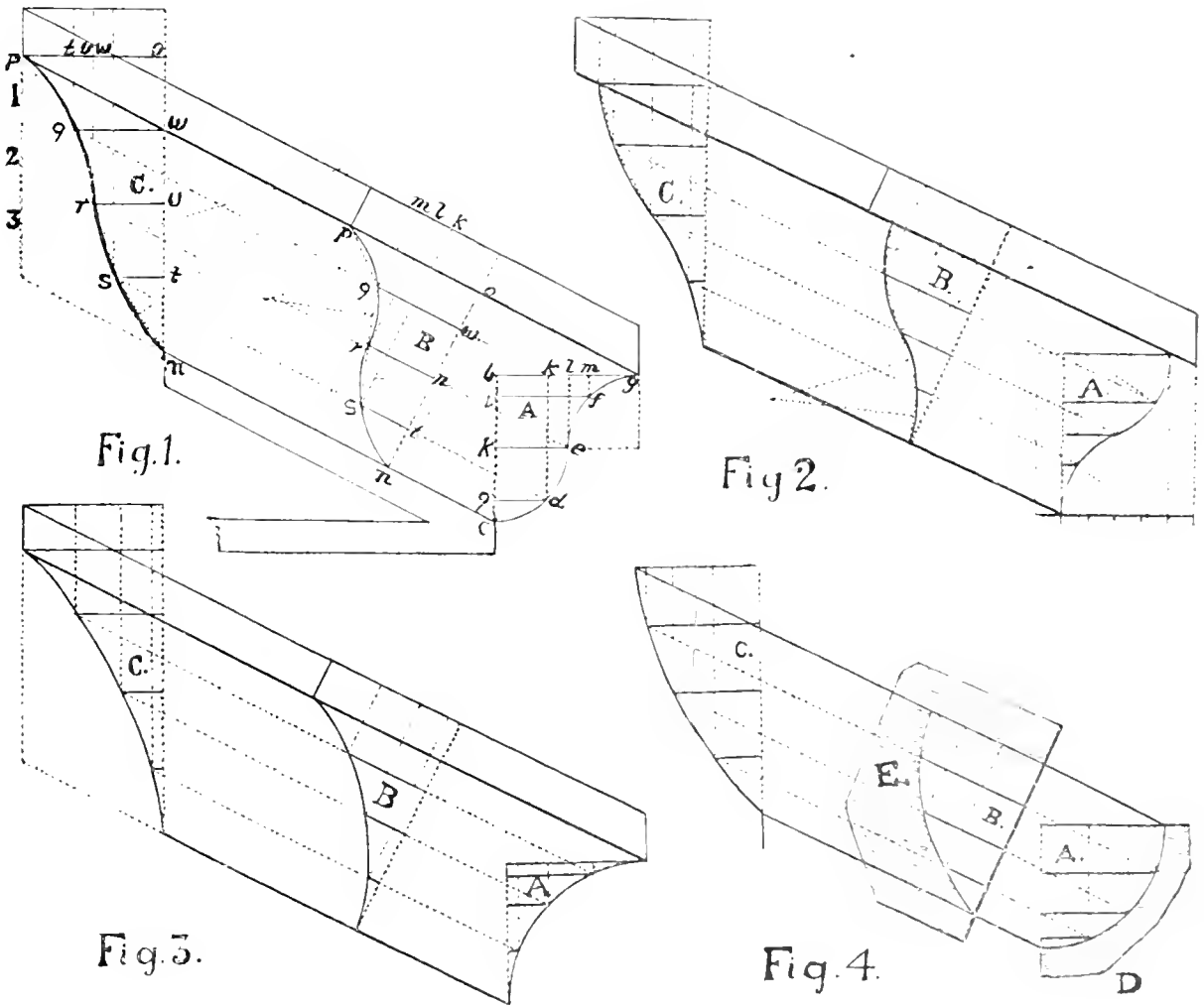

No. 46.—RAKING MOULDINGS.

used for describing the profile of the returned cyma-recta in the inclined cornice in an open pediment; also to return a raking moulding to a level moulding at the top. First draw a horizontal line from the fillet as at p to o , at C , Fig. 1 on illustration No. 46, making the length equal to the projection of the corresponding line $p o$ in B which is also equal to the line $o g$ in A , and then divide the line no in four equal parts, and from these points u, n, t draw horizontal lines, keeping them equal in length to the corresponding lines $q u, r n$, and $s t$ in B . Next on the line $p o$ set out the points for the lines t, u, w , making them equidistant to the lines m, l, k ,

in B, and then from these points draw lines parallel to ne till they cut the raking lines in the points q, r, s . Having obtained these points, trace the curve from p to n through the points q, r, s , which gives the profile of the returned member. The curve can also be described from centres, one of which is shown. The same methods are employed for describing the profiles of the cyma-reversa, the cavetto, and the ovolo, as shown at Figs. 2, 3, and 4 respectively on illustration No. 46.

When running the raking and other mouldings on a pediment, the running moulds are cut and horsed in the usual way as shown at D illustration No. 46, but when running them for fixing purposes or for model-making, the running moulds should be horsed so that the moulding can be run on a running board; also that the moulding will have a bed for fixing purposes. The method of setting out the running mould for this purpose is effected by extending the back bed of the moulding, then cutting the running mould to have two bearings as shown by the section of the mould plate at E. The foregoing methods can be employed for circular raking mouldings, also for reverse running moulds for fibrous plaster, and for concrete work.

RAKING MODILLIONS.—The method of setting out an Ionic modillion for a horizontal cornice, and the raking modillion for a pediment or an inclined cornice, is elucidated on illustration No. 47.

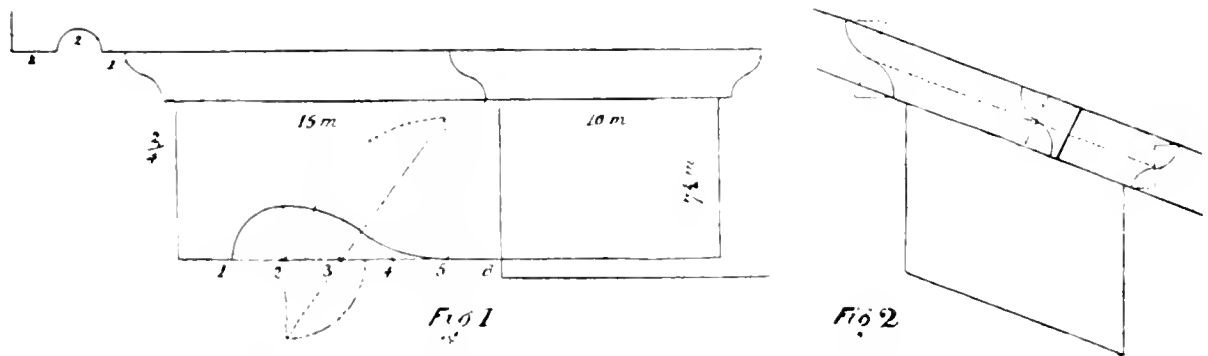

NO. 47.—SIDE AND FRONT ELEVATION OF IONIC MODILLION, WITH RAKING MODILLION.

Fig. 1 shows side and front elevations, with sections of an Ionic modillion, and a part of the soffit of the corona for a horizontal cornice. The method of setting out the modillion is indicated by the figured proportions, and the dotted lines, and centres; the latter being used for drawing the curved section. Fig. 2 shows the method of setting out the raking body and moulding of the modillion for the inclined cornice of a pediment. The raking moulding is set out by the aid of compasses, as already described and indicated by the dotted lines and centres. The above method may be employed for setting out other forms of raking modillions.

TO CONSTRUCT A DORIC PORTICO.—It will greatly simplify the working, and give the workman, especially in his initial efforts, a better grasp of the method of construction, if he first draws the work to scale. The annexed illustration No. 48 will explain the method of setting out and drawing the main parts. To set out a Doric portico or frontispiece, first draw the base line AB , and erect the perpendicular line II , and on this mark the height of the first or uppermost member of the horizontal cornice as at II , according to the number of diameters in the order. Divide the entablature into its three parts, viz., architrave (composed of two fasciæ, with a fillet also termed "tenia"), the frieze, and the cornice. A triglyph, P , is always placed over the columns, and its breadth

is equal to half the diameter of column at its base. The distance between the triglyphs is generally equal to the height of the frieze, therefore square. In some examples there are various numbers of triglyphs placed between those over the columns according to the length of cornice, but in this example there are three. The intercolumniation for the three triglyphs, according to the scale of this order, is five diameters, that is, the distance from the central line *C E* to the central line *D F*. The intercolumniation being found, take half thereof between the compass, and setting one foot in the point *I*, make a point at each side upon the line *A B* at *C* and *D*, and then erect the perpendicular lines *C D* and *E F* for the central lines of the columns.

The triglyphs are spaced out on the base line *A B* as follows:—Take fifteen minutes, the half breadth of one of the triglyphs between the compass, and make a mark on both sides of the point *C* as *a, b*, and on both sides of the point *I*, as *e, f*, and on the point *D* make two points as *c, d*. Now take forty-five minutes, the height of the frieze (which is the width of the metopes between the compass, and place one foot on the point *f*, and make a point as at *h*, and then from the point *e* make a point as at *i*, from *g* to *h*, and also from *i* to *k*, which is the width of a triglyph. It will be seen that this method gives the width and positions of the other triglyphs as *a b, f c*, and *c d*. These widths and positions are then transferred from the base line to the frieze, working from the centre lines of the portico and columns. The width and positions of the metules are regulated by the triglyphs. The height of the members of the cornice are set on the centre line of the column from the point *f*. The two upper lines that make the square of the cyma-recta are omitted because of the circular cornice mitring to the level returned cornice. The projections are taken from the centre

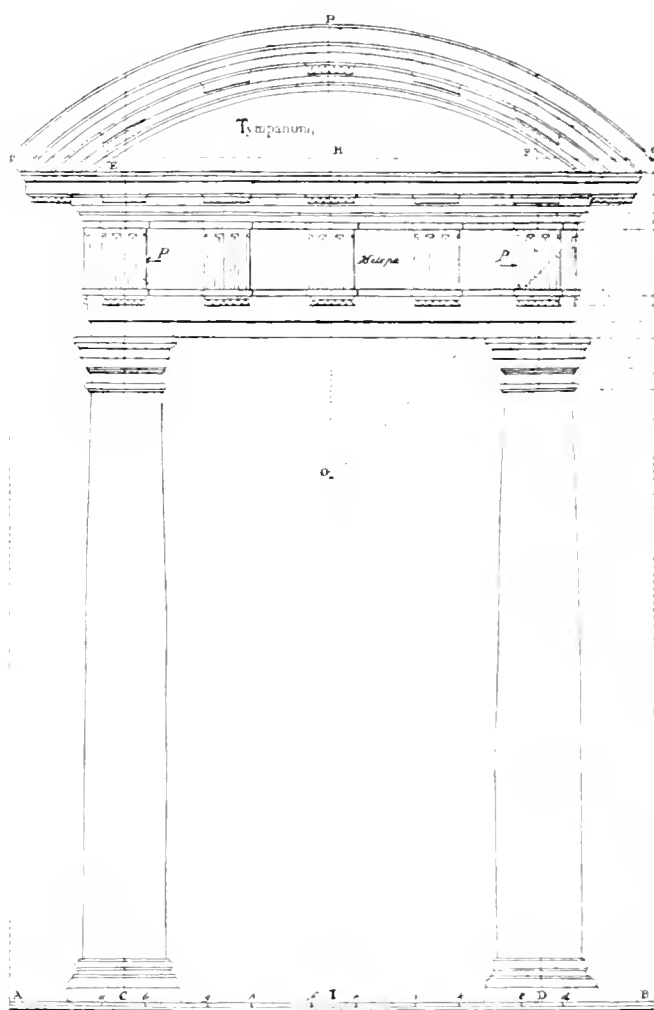

NO. 48.—SETTING OUT AND FORMING A DORIC PORTICO.

line of the column. To find the pitch of the pediment, set one foot on the point *H*, extend the other to *G*, and then turn this foot to the centre line *I H*, and make the intersecting point *Q*, which is the centre for the circular pediment, also termed a compass pediment. The same rule is also used to find the centre for a raking or angular pediment, as shown by the dotted line *R* to *G*.

The space between the triglyphs are called metopes, and are generally filled in with some ornament. In some antique examples the metopes are alternately enriched with ox-skulls and with pateras, but they may be filled in with any other ornament of appropriate form. The method

of drawing the triglyph, guttae, and panel with patera is further elucidated by the annexed sketch (No. 49), which shows the elevation and section, with the parts figured, and is self-explanatory. The guttae or drops in this example are pyramidal in form, but in many examples they are conical, being cones, or parts of cones. The soffit of the corona is often enriched. These enrichments should be sunk up, and never drop lower than the line of the soffit. Three forms of mutules, a "centre" and "rights" and "lefts" as shown in illustration No. 48), are required for the circular cornice, so that their sides will be perpendicular and rake with the sides of the mutules on the horizontal cornice. The "rights" and "lefts" require to be specially made. The centre one may be obtained from the casting mould of the mutules for the horizontal cornice by bending it to fit the curve of the circular cornice. The front and sides of the mutules are sometimes enriched by a series of dog-tooth sinkings, as shown by the centre mutules and two external ones.

The method of forming a portico in Portland cement is as follows:—First form vertical screeds on the walls close to the outer sides of the columns, taking care that they extend from the plinth of the column to a little above the level of the apex of the pediment, then fill in the plain intermediate spaces and rule them off, using the vertical screeds for bearings. On this surface set out the full size of the main parts of the work to be done. All measurements should be taken from

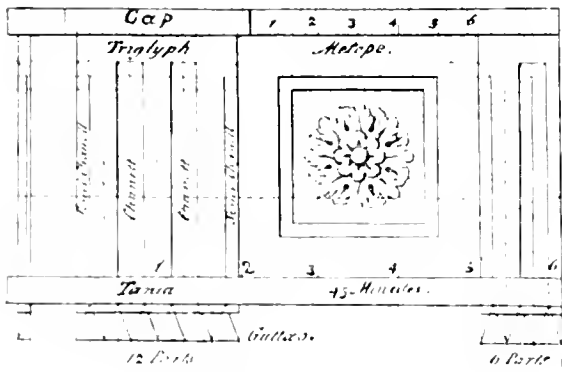

NO. 49. — SETTING OUT TRIGLYPHS.

the centre of the portico. This centre line is obtained from the centres of the columns, as described for the setting out. If the work is large, or the pediment to be run, the circular cornice or angular cornice, as the case may be, should be run first, so as to save long mitres, also to prevent stuff falling on the horizontal cornice, which sometimes happens if the latter is run first. For small work, the horizontal cornice and the architrave are run first. This is done from a parallel running rule fixed on the frieze. If the work is large, fix two running rules on the frieze, one for the cornice and one for the architrave. In both cases a running rule

is required for a bearing for the nibs of each running mould, one fixed on the weathering at the top of the cornice, and one on the soffit of the architrave. After the mitres are "put in," the tympanum is fined, and then the mutules and triglyph are fixed. The upper surface of the pediment and the portico is fined as soon as the mould of the cast part is taken off. The columns and the soffit of the architrave are next formed, the former being carried out in a similar way as described for diminished columns.

TO CONSTRUCT AN IONIC NICHE.—The subjoined illustration No. 50, shows the elevation of a niche in the Ionic order with columns on pedestals. The height of the niche is 2 diameters and $\frac{1}{2}$ inch, and to the top of the keystone 3 diameters. The height of the impost, breadth of the architrave, and the size of the keystone are explained by the circles. An inverted circular pediment is here given, but an angular or pitched pediment, as shown by the dotted lines which extend from the extreme angles to the apex of the pediment; may be used instead of the circular pediment if required. The dotted lines on the bases and columns indicate the centres from which the niche is set out.

The method of construction in Portland cement is as follows:—First plumb the walls, and

form vertical screeds near the outer sides of the columns. The screeds must be plumb, and extend from the plinth of the pedestal to a little above the level of the apex of the pediment, then form vertical screeds on the piers, also at the sides of the panel space between the pedestals, taking care that they are plumb, also parallel in projection with the outer screeds. This done, fill in all the intermediate plain spaces, and rule them off from the vertical screeds. The pediment is next formed, this being done as described for pediments. Here the advantage of casting the circular cornice *in situ* will be seen. If this had to be run, the core of the horizontal cornice would require to be cut away to allow the running mould to pass to the external angles, which otherwise would entail extra long mitres, and being circular, they would be more difficult to form. A long mitre would also occur at one side of the apex mitre, as only one side of the circular cornice could be run the full length. In this example the frieze is swelled. This may be run with a template after the cornice and the architrave is run. For this method, about 1 inch deep of the swell at top and bottom are run with the horizontal cornice and the architrave. An allowance must be made for this when cutting and "horsing" the respective running moulds.

Another way is to cut two templates to the curve of the swell, and fix them temporarily on the surface of the frieze, each about 6 inches from the mitres. The spaces between and beyond the templates are then filled in and ruled off until flush with the templates. When the stuff is firm, the templates are extracted, and the holes formed by the templates are filled in, thus leaving a fair and true curved surface for the fining coat. When a swelled frieze is cored out in brick work, form screeds at the top and bottom of the frieze, and on these fix running rules for running the horizontal cornice and architrave (as already described, and then run the swelled frieze. Another way to form the frieze is to make narrow vertical screeds at each end, with a wooden template cut to the curve of the frieze, and then fill in the intermediate space and ends, and rule the surface fair with the screeds, and when the stuff is set proceed with the fining. The modillions are next fixed. Three different

forms of modillions are required for an inverted circular pediment—one for the centre, one for the "rights," and one for the "lefts," on each side of the centre one. These require to be specially made, so that they will fit the curve of the cornice and their sides be perpendicular. It may here be remarked that the construction of the three different models of the modillions entails a considerable amount of labour. This, with the addition of making a casting mould for each model, will double the labour required for making a model of a modillion for the horizontal cornice. Under these circumstances, it would be a simple matter of justice to the client and the plasterer, if all quantity surveyors would make a note of every item, however small, which requires to be specially made, so that they can be valued and allowed for in the

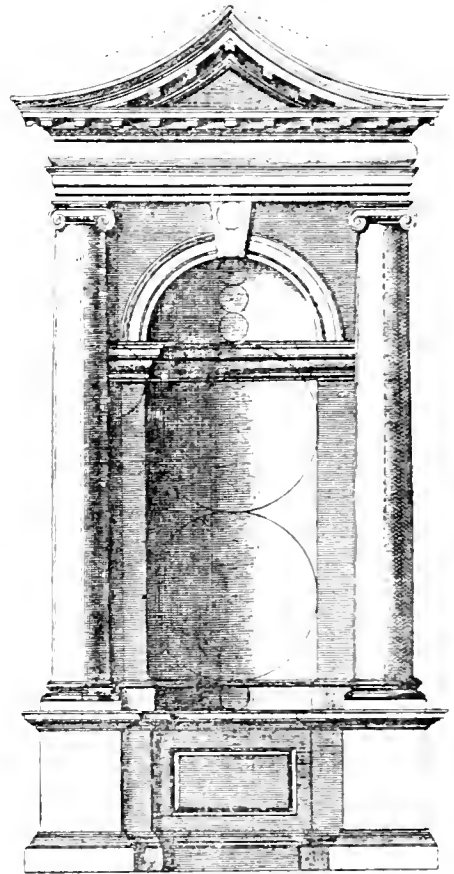

NO. 50.—SETTING OFF AND FORMING
IONIC NICHE.

plasterer's estimate. After this slight digression, the method of construction will now be resumed. The circular crown and body surface of the niche is next formed, as described and demonstrated by illustration No. 43, in Chapter VI. The archivolt moulding is next run, and then the crown of the niche finished. The circular impost moulding is next run. This may be run from a running rule bent to the circle, taking care to keep it level. The columns are next formed, this being done as described for diminished columns. The keystone is then fixed, and the straight lengths of the impost mouldings, which form caps to the piers, are then fixed. These are run down, and then cut to the required lengths and mitres, taking care to cut the butt ends to fit the curve of the columns. The impost mouldings are fixed before the columns are fined, as it is easier, and makes cleaner work, to fine the columns to the members of the cornice than it is to make good the members of the cornice to the column after it is fined. The pedestals and the panels are then formed, as described hereafter. It will be understood that all the plain surfaces are finished as the work proceeds.

TO CONSTRUCT A PEDESTAL.—The annexed illustration No. 51 is an example of a pedestal. A pedestal has three parts—the base, the die, and the cornice or surbase, commonly called a "cap." The height of a pedestal properly proportioned is from one-third to three-tenths the height of the column; the die is nearly of the same figure, being a cube, or made as high as the width of the plinth belonging to the column it supports. The whole height of the pedestal may be divided into nine parts, one of which must be given to the cornice, two to the base, and the remaining parts to the die. The projection of the cornice should be equal to its height. With regard to the method of constructing in Portland cement on a brick foundation, the die is first floated, taking care that the screeds are plumb, and that the sides are square with each other. The cornice is run from running rules fixed on the die and nib rules on the upper surface. The base may be run with a twin-slipped mould from a running rule fixed on the die, or it may be run from a rule fixed from the plinth member formed in the same manner as described for skirting. The latter way

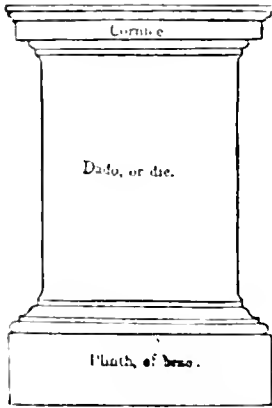

No. 51. PLAIN PEDESTAL.

allows the full length of the moulding to be run, thus avoiding long mitres. When constructing a model of a pilaster in plaster, the cornice and base mouldings may be run down, cut to the lengths and mitres, and then planted on the die. It will be understood that the die should be made sufficiently high to include the heights of the cornice and base, so as to afford a ground for running, or fixing the mouldings thereon. When constructing pedestals in fibrous plaster, a casting mould made by the reverse moulding process should be used.

COMPOUND OPEN PEDIMENT.—The accompanying illustration No. 52 elucidates the method of setting out and constructing a compound open pediment. This shows nearly one-half or side of the pediment. The intersection of the circle line with the horizontal line at *t*—when continued—gives the centre of the complete pediment. To set out half of the compound circular cornice, divide the whole length of the half pediment into four parts and return the cornice at three of those parts as shown at *AB*. The centres *C, C*, from which the reversed curves of the cornice are struck are obtained from the oblong as indicated by the dotted lines *D C, B C*. The dotted diagonal line from *c* to *c* gives the intersections of the reversed curves. This form of pediment is best made by making a plaster model, then moulding and casting as many as are required. To make the model run a length of each curve, then joint and fix them together, and then form the scroll end by hand

and the aid of a template. The patera is modelled, cast, and then planted. This done, run a straight piece of the top member—the cyma-recta—and cut it to the desired lengths and mitres, to form the straight parts of the cornice which intersect with curved parts at the ends, and also to form the returned mitres. The returned member above the scroll end can be worked by hand. The other side of the pediment is of course made in the same way. The horizontal cornice H is generally run *in situ* and the compound circular parts planted on it; but for small work the whole pediment can be cast in one piece and then planted. The horizontal cornice can also be run *in situ* and the circular parts cast *in situ* with the aid of a plaster mould as already described.

BLOCK CORNICES AND QUOINS.—Cornices having blocks or trusses, especially of the classical orders, are usually set out from a scale or module, as shown by the figures on illustration No. 54. The projections of the members are taken from the perpendicular line. As regards the working, if the cornice is large, a screed is formed on the bed of the blocks, and the upper and lower portions run from a parallel running rule fixed on this screed. The annexed illustration No. 53) shows the front and side elevations of a modillion or console commonly called a block, from the Temple of Jupiter Stator, Vatican, Rome.

This form of modillion is often used for exterior work. When fixing blocks, or similar work of a heavy nature, care must be taken to obtain a permanent support by driving strong nails into the vertical part of the bed, or by fixing pieces of slate on edge and bedding them with cement. A hole sufficiently large to receive the nail and a coating of cement must be made in the backs of the blocks while they are being cast. The blocks should

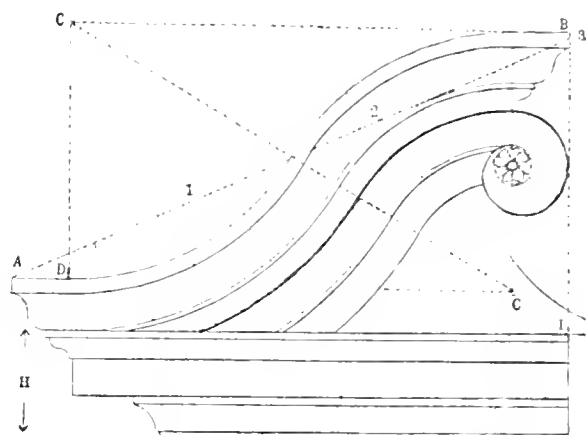

No. 52.—SETTING OUT AND FORMING COMPOUND OEGE PEDIMENT.

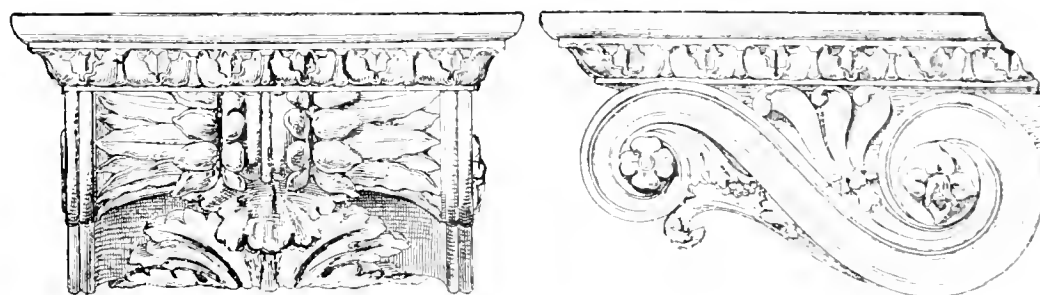

No. 53.—FRONT AND SIDE ELEVATION OF MODILLION FOR EXTERIOR WORK.

be fixed with neat cement, gauged with lime putty in the proportion of 3 parts of cement to 1 of lime. Heavy blocks are temporarily supported by wood struts, also by gauged plaster. These are removed when the cement is set.

Quoins must be accurately set out according to their size, from the bottom member of the cornice down to the base. The heights of quoins are usually equal to half the depth of the cornice, and are in proportion to one another for length as 2 to 3, and the splayed

Plastering—Plain and Decorative.

edges are cut off one-eighth of their height. If the quoins have a large projection or a small moulding on their edges, they may be cast and then planted in position. In some instances a brick core is built for the quoins; it is then necessary to run them *in situ*. For ordinary sized work the whole surface of the quoins from top to bottom is roughed out to the desired thickness after the walls are floated. This is best done by nailing thickness rules to the desired outline on the walls. The space is then filled in with gauged cement similar to that used for floating the walls. When the stuff is firm but not set the sinkings are cut out, allowing a sufficient depth for the running mould and a thickness of fine stuff. Running rules are then fixed on this surface, and then the splayed, square, or moulded sunk joints as the case may be are run as already described. The sinkings especially if splayed may also be fined by hand, while finishing the surface of the quoins. In this case the sinkings must be more carefully cut out, and the depth and form may be better determined by the aid of a template. A rule with a V-shaped edge, or a feather-edged rule and a V-shaped hand-float, are useful tools for this kind of work. The surface of quoins is usually vermiculated. This is done with a knife before the stuff is set. Considerable variety of form and effect can be imparted to vermiculation.

A plain margin is left on the edges of the quoin, and from this a series of irregular or zigzag bands (somewhat smaller than the outside margin) is formed across, and the inner portions are sunk, leaving a rough or matted surface. In order to obtain a surface sufficiently plastic to be easily cut, and also a uniform depth for sinking the intermediate spaces, it is best to run a surface margin with the plain or moulded sinking between each quoin. It will be seen that this leaves a sunk space on each quoin. This allows one or more quoins to be filled in, and vermiculated as required, according to the time required

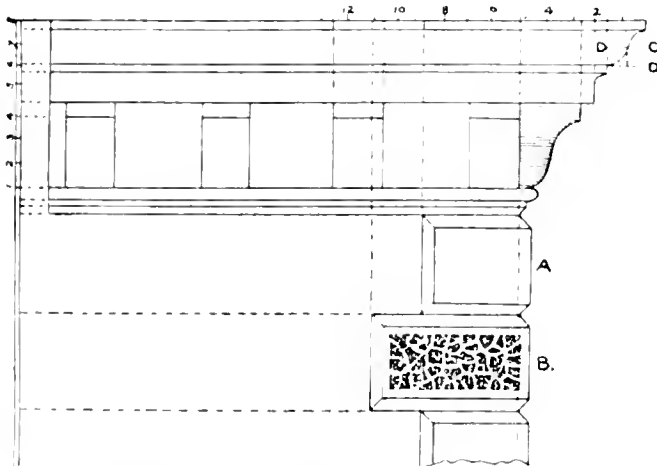

NO. 54.—SETTING OUT AND FORMING BLOCK CORNICE AND QUOINS.

for vermiculating before the stuff is set. When roughing out the thickness of the quoins, an allowance must be made for the depth of the margin on the edges of the quoins, which represents the finished surface. Another form of vermiculation consists of leaving the whole quoin, with the exception of a margin on the edges, with a strong jagged surface. Quoins are also sometimes left with a matted surface. The jagged surface is done with a knife, and the matted with a rough-faced or matted hand-float; also by laying a piece of thick, rough, and open canvas over the surface, and beating it with a hand-float. A sheet of zinc, with a series of punctures leaving their edges or points projecting, may also be used in a similar way. Vermiculation in some cases projects beyond the outer margin of the block. In this case a somewhat regular rock-like surface is left. This is best done by hand, and when cut the surface may be further roughened by stabbing it with a coarse and stiff brush. Illustration No. 54 elucidates the various parts. A shows the end or small quoin, left plain; B is the large or face of quoin, vermiculated. The dotted lines at C, dividing the square into four smaller squares, show a method of forming a "cyma-recta" composed of two equal quadrants (or quarters of a circle), which are described from the points D, D.

Verniculated work is often used on keystones and basements. Rustication is also another form of finishing stone surfaces, the face being worked to produce a rough or crispy surface.

TO SET OUT QUOINS.—The method of setting out the quoins of a building is elucidated in the annexed illustration (No. 55). First draw the base line $a c$, then erect a perpendicular line as $a b$, then erect the line as $g h$, and the line $e f$, each line being set out according to the required size of quoin. The line $a b$ represents the external angle of the house, the line $g h$ the internal line of quoins, and $e f$ the external. Suppose $a b$ to be the height on which the quoins are to be disposed, and on the supposition that there are to be twelve quoins; divide $a b$ into twelve equal parts, and through the points thus obtained draw lines parallel to $a c$, $i d$, and so on to the top.

GATEWAYS AND RUSTICATION.—Rustication is capable of expressing ornateness. It forms a bold finish, prevents baldness and insipidity, produces richness of surface, and what in architectural language is termed *color*. The joints of the stones may either be square or chamfered; the square one should not be wider than one-eighth of the height of the stone, nor narrower than one-tenth, and their depth nearly equal to their width. Chamfered joints should form a rectangle, and the width of the whole joint may be from one-fourth to one-third of the height of the flat surface of the stone. The annexed illustration (No. 56)* is given to show the method of working rusticated work and "vermiculated" surfaces. Fig. 1 is the plan and elevation of a rustic gate in the Tuscan style. After the walls are screeded, the pediment, entablature, archivolt and impost mouldings, and the columns are executed as already described. The shell in the "tympanum" and the ox-skull, and the swag of leaves on the frieze, may be modelled *in situ*. Work of this nature, when modelled *in situ*, is more effective and economical than cast work, and being worked on the surface while green, it forms one body, and is generally stronger than cast work which is planted. The cone vases should be cast. The rustic blocks on the columns are formed by fixing bands on the columns and then filling in the spaces, and ruling flush with the bands. The bands are made of plaster and to the desired projection of block beyond the line of column. The surface for the rustication must be floated out to the required depth of the sunk joints. The position of the various stones with their joints are then set out, and the joints cut out and fined, or run as already described. The vermiculation on the swelled frieze of the entablature, the blocks on the columns, and the wall surface is done before the cement is set hard. Fig. 2 is the plan and elevation of a gate or entrance in the Doric style. This is executed in the same way as described for Fig. 1. The blocks on the columns are square on plan.

COLUMNS AND ARCHES.—The method of placing columns over columns and arches over arches, and the setting out and construction of same, is elucidated on the annexed illustration (No. 57). This shows the Corinthian order over the Ionic on a rustic basement. The upright scale shows the height in diameters of the orders and their principal parts. When two or more orders are employed and placed upon each other in a building, the laws of solidity require that the strongest should be placed lowermost; therefore the Tuscan is to support the Doric; the Doric the

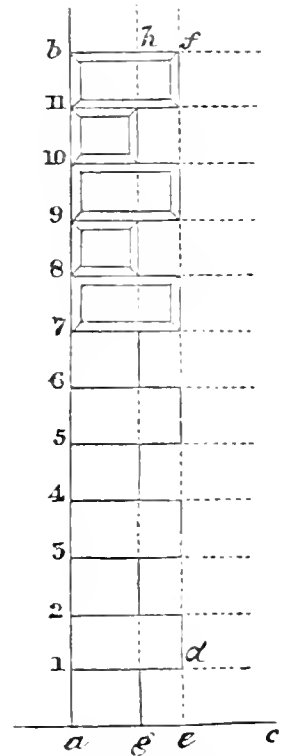

No. 55.—SETTING OUT QUOINS.

* From designs by Sir W. Chambers.

Ionic, the Composite, or Corinthian; and the Composite the Corinthian. By this arrangement the plainest or most massive are placed lowest, and the most enriched highest. The first or lowermost order gives the size of the diameter to the order immediately over it, as shown by the Corinthian over the Ionic on the illustration. It will be seen that the diameter at the base of the Corinthian column is equal to the diminished part of the Ionic column. The diameter of the upper order is

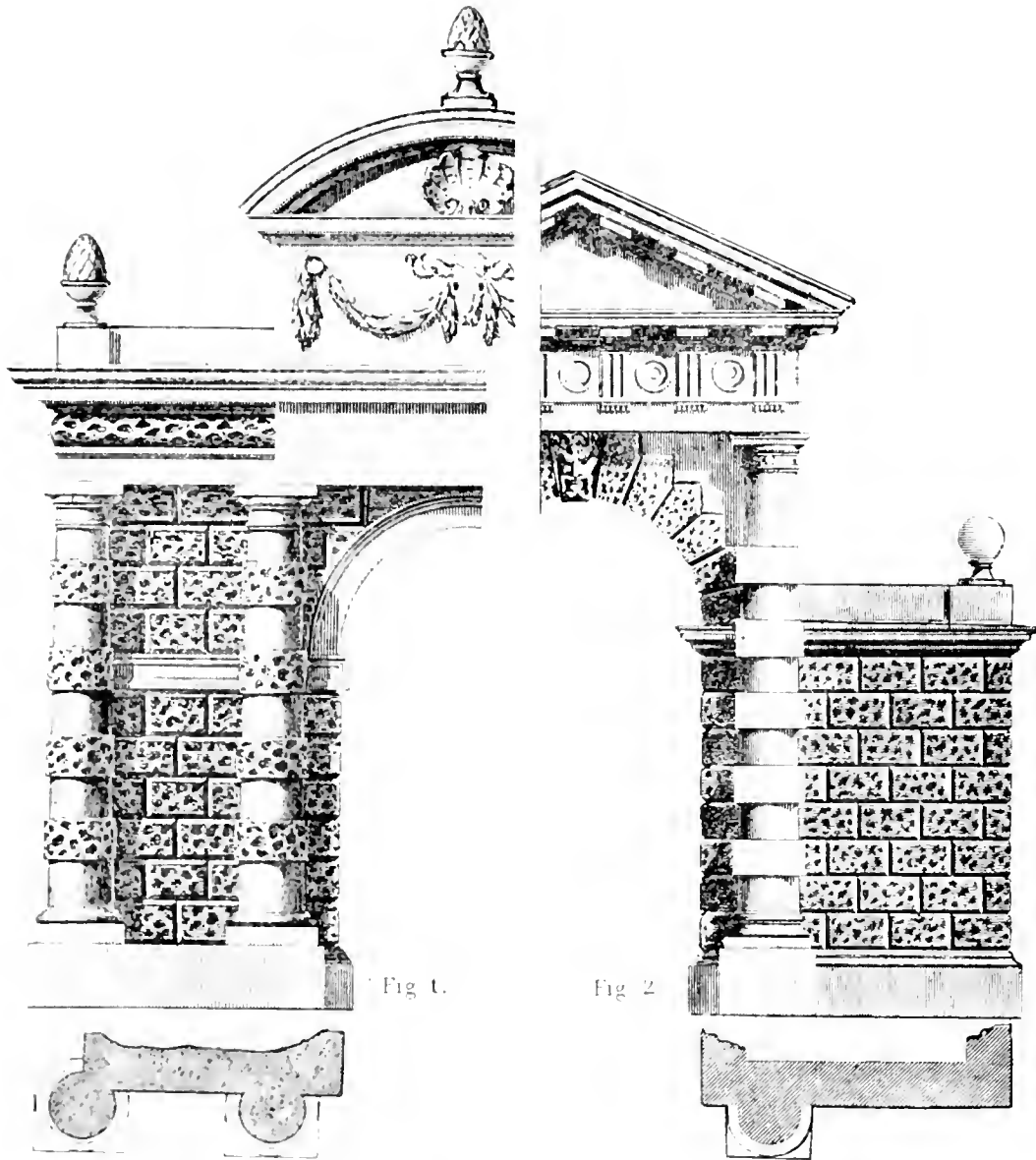

NO. 50.—PLAN AND ELEVATION OF GATEWAY, WITH RESTRICTIONS.

therefore regulated by the diminish of the lower order. The diameter of the upper order may also be obtained by dividing six diameters of the lower order into seven parts, one-seventh of which will be the diameter required for the upper order. In this and all other classical compositions, the intercolumniation is decided by the diameter; as also by the divisions of the metopes and triglyphs of the Doric order, and the modillions of the other orders. Their proportions in respect to the

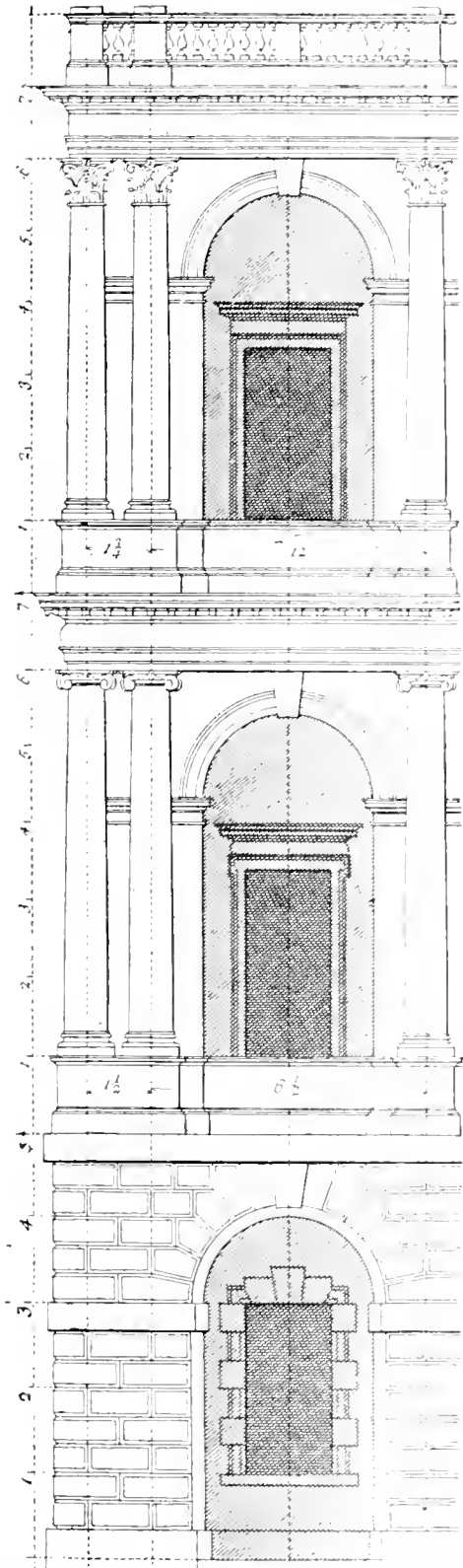

No. 57.—COLUMNS AND ARCHES. THE CORINTHIAN ORDER OVER THE IONIC ON A RUSTIC BASEMENT.

diameter are as follows:—The Doric from centre to centre of the triglyphs is $1\frac{1}{4}$ the diameter, the triglyphs $\frac{1}{2}$, and the metopes $\frac{2}{3}$. The Ionic from centre to centre of the modillions is $\frac{1}{2}$ the diameter, the modillion $\frac{1}{3}$ and the interval $\frac{2}{3}$ of it. The Corinthian from centre to centre of the modillions is $\frac{1}{2}$ (twelve times in seven diameters) of the diameter, the modillion $\frac{1}{3}$, and the interval $\frac{1}{12}$. The Composite from centre to centre of the modillions is $\frac{1}{2}$ the diameter, the modillion $\frac{1}{3}$, and the interval $\frac{2}{3}$. In placing columns above each other the axis of all the columns must correspond as indicated by the dotted lines. This example shows the intercolumniations with three-quarter columns. The distances betwixt centre and centre of the columns are figured. As a general rule the pedestals should not be less than $\frac{1}{4}$ of the combined height of the column and entablature; but here it is necessary to make it less, otherwise the breasts of the windows would be too high, if the columns were of a large diameter.

With regard to arches over arches, they must always be regulated according to the lowest order for the same reasons as stated for columns, and so that the modillions may principle or fall regularly over each other. When arches are adorned with columns or pilasters, with or without pedestals, the columns or pilasters should be so disposed as to leave sufficient space for the arch and its architrave. The architrave round the arch is generally $\frac{1}{4}$ of the void of the arch, and the impost the same. The impost is similar to a capital, because it supports the architrave.

This illustration also shows the method of disposing the pedestals, piers, or dies, and the balusters of a balustrade. The height of a balustrade is regulated in a great measure by its use, and cannot well be lower than 3 feet, nor should it be higher than 3 feet 6 inches or 4 feet; nevertheless it must necessarily bear some proportion to the rest of the architecture as here defined by the upright scale. It will be seen that the centres of the pedestals are in the same perpendicular line with the axes of the columns, and that the die of a pedestal is in the same perpendicular line with the key-stones of the arches. This die is omitted and the balusters carried from pedestal to

pedestal where windows or flat openings are used instead of arches as here shown. The plinths on the top of the pedestals are used as stands for statues or vases which are sometimes used to adorn façades of buildings. When statues are placed upon a balustrade, their height should not exceed one-quarter of the column and entablature on which the balustrade stands. The height of vases should not exceed two-thirds of the height given to statues. This illustration also shows an example of rustication. The method of setting out and constructing this and other rustic varieties has already been given.

With regard to the method of constructing this façade in Portland cement, the whole is executed as already described for the individual parts. It may be added that the three-quarter columns should be ruled off before the walls are flanked in and the impost mouldings run, so as to allow the curved and diminished surface of the columns to be more freely worked and carried into the brick work. The wall surface being straight, can be more readily flanked, and the angles formed against the circular surface of the column, than *vice versa*. The architrave mouldings should be run before the impost mouldings are run. The whole of the façade must be made plumb by means of dots or nails, and the positions of the columns, cornices, arches, and balustrade set out, measured, and proved before the running of mouldings is commenced. The work should be begun at the top and finished downwards. This method allows the scaffold to be removed as the work proceeds, and the putlog holes to be filled in and a complete section or bay to be finished in one operation. This illustration will be of some service in setting out and constructing similar designs in cast artificial stone, and for concrete formed *in situ*.

TO CONSTRUCT A BALUSTRADE.—Balustrades may be constructed either *in situ*, or cast and then fixed *in situ*. When constructed *in situ*, the balusters are always cast—in some examples the cornice or rail over the balusters is also cast—and then fixed *in situ*. Various methods are employed for constructing balustrades *in situ*. The one here given is one of the best. The most difficult part of the process is the running of the cornice over the balusters. This operation and the construction of the complete balustrade is elucidated by the subjoined illustration (No. 58).

The first part of the process is setting out the positions of the pedestals, also the dies, if there are any in the design. The sides and upper surface of the base between the pedestals are floated, care being taken to keep the sides parallel, and the top level. The base mouldings are run before or after the balusters are fixed, according to the projection of the top of the base beyond the balusters. A half baluster is then fixed on the flanks or inward sides of the dies, taking care that they are central and plumb, as they form a datum or guide for fixing the intermediate balusters. The positions or distance apart of the intermediate balusters are then set out on the top of the base, and then a joggle is set out for each baluster. This done, a wood fillet about 1 inch square, and in length equal to the distance between the dies, is fixed on the base and against the plinths of the half balusters. A stout flooring board, or a piece of quartering about 3 inches wide and 1½ inches thick, is fixed against the upper plinth, taking care that it is below the top of the plinth, to allow space for materials and the lower member of the running mould when forming the cornice. It must also be fixed perfectly level, otherwise the cornice will not be level. This is called a "rail-rule." If a flooring board is used, the slipper of the running mould must be rebated, so as to bear on the upper edge of the board. If a piece of quartering is used, it must be planed on the outside, and a piece of ordinary running rule fixed also on the outside to form a screed and bearing for the cornice running mould. The top rail-rule is supported with wood props placed at intervals, and so arranged that they will be in a line with the spaces between the balusters, so as to give more freedom when fixing the

latter. The balusters are now fixed on the base, using the rail-rule and the fillets as guides for keeping them linable, level, and plumb. Their proper position is further ensured by the aid of marks which have previously been set out on the rail-rule and fillet, also by testing with a wooden gauge. As soon as the balusters are fixed, a rail-rule similar to the first is fixed on the other outside of the top plinths. This is supported by props as before. The outside and the inside rail-rules are tied together by means of pieces of rule rebated at the ends, so as to clip the props. A core for the cornice, composed of tiles and cement, is now formed on the upper ends of the balusters. This is effected by first filling in the joggles in the tops of the balusters with Portland cement, allowing it to protrude sufficiently to form a bed for the first row of tiles. When this is done, lay more cement on this row, and lay another row of tiles, and so on, until the desired size and form of the cove is obtained. When laying the tiles, break the joints by overlapping, so as to obtain greater strength; also be careful to allow a sufficient space between them and the profile of the cornice, so as to obtain a requisite thickness for the cement with which the mouldings are formed. The average thickness for this purpose is 1 inch. In no case should it be less than $\frac{3}{4}$ inch. If otherwise, the work is liable to crack or laminate. This is an important point in the formation of brick, stone, or tile cores, and also in the angles of brick work used in buildings subsequently to be plastered, for unless the cement work is of the necessary thickness to give it an independent strength, the work will crack or scale. If the cement work is too thin, the suction caused by the tile or brick work deprives the cement of its necessary water before it has had time to properly set, thus rendering it inert and weak. The laminations to be seen in some of the work done in the early days of Roman and Portland cements are due in many cases to a sparseness in the thickness of the material.

A guide for regulating the projection of the core can be obtained by cutting rough templates to the section of the cornice, and fixing them on the dies, and then stretching a cord over them. If the caps are on the pedestals, guides for the core may also be obtained from the butt joints, which are generally cast with them; but if the caps are run *in situ*, the profile of the cornice can be marked on the sides to act as guides.

After the core is made, fix a parallel rule on the top of the core to act as a nib-rule for the cornice mould at each side. The top of the cornice is finished by hand, after the mouldings are run. For parapets the top should have a fall of about $\frac{1}{2}$ inch to allow rain to run off. Sometimes the top takes the form of a flat curve or "saddle back." In this case the curve is formed with a curved template. The rail-rules are now taken off, and the soffit of the moulding finished by hand. After this the moulding on each side of the base is run. This is done from a slipper running rule fixed on the plinths and a nib-rule fixed on the bottom plinths of the balusters. For small work, where there is not room for a nib-rule, the base mouldings are run from a parallel rule fixed on the top of the base. In this case the mouldings are run before the balusters are fixed, and the work must also be covered with wet sand or with boards to protect the mouldings from splashes

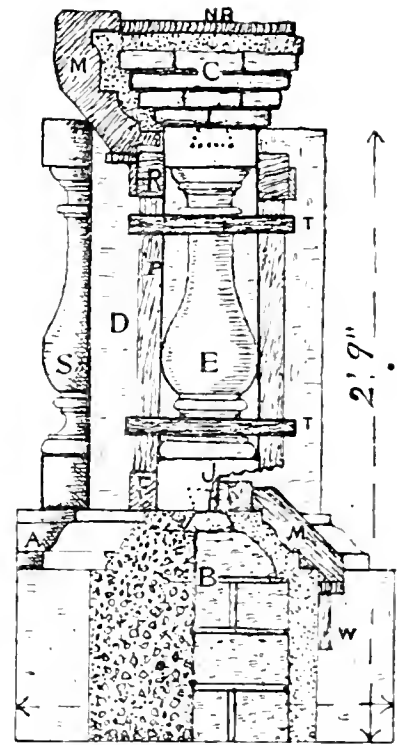

No. 58.—BALUSTRADE CONSTRUCTION.

and injury while forming the work above. This is a general outline of the process for forming balustrades *in situ*, the details of which are as follows.

Take the pedestal on illustration No. 58 as one of the two pedestals between which it is proposed to construct a length of balustrading. The elevation of the flank or inward side of a pedestal is shown, but without the cornice. The height and width of the pedestal is indicated by the darts. The base, B, may be cored out with brick work or concrete. If there is no brick work previously made, then the plasterer should form the core with coarse concrete. Concrete for this purpose is a more suitable material than either brick or stone. One-half of the core of this base is shown as being formed with brick work, while the other half is made with coarse concrete. It will be seen when concrete is used that only a thin coat of finishing stuff is required on the concrete, whereas a floating coat—as indicated by the fine dotted surface—is required on the brick work. Having floated the sides and top of the base and run the mouldings, a section of the running mould, M, and the slipper running rule, W, and the nib-rule, X, are shown in position when running one side of the base moulding. The half baluster is fixed on the die, D, keeping the lower plinth fair with the screed on the top of the base. T is the elevation and S is the section of the half baluster. Repeat this on the other pedestal. This done, set out the positions of the balusters, and

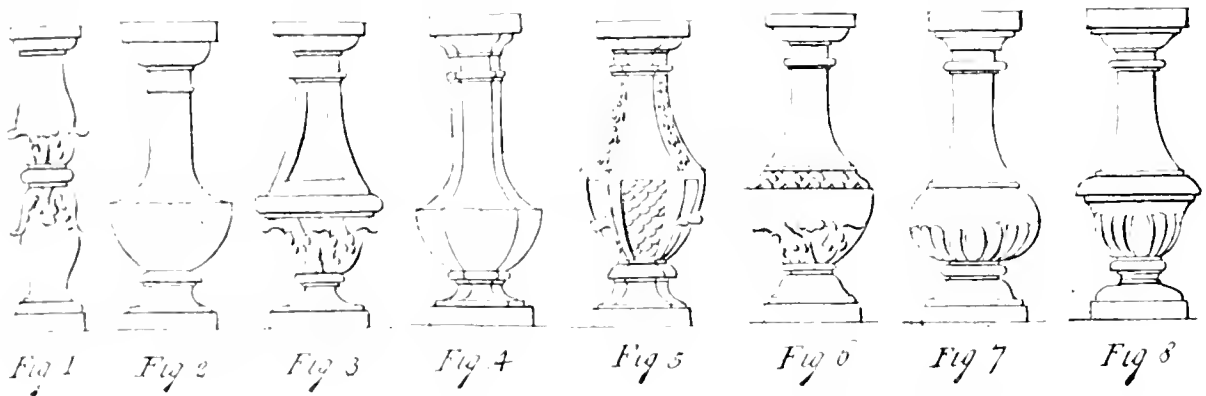

NO. 59. PLAIN AND ENRILED BALUSTERS. ROUND, SQUARE, AND OCTAGONAL ON PLAN.

cut a joggle for each on the top of the base. After this fix the top rail-rule, R, and the fillet, F, and support the rail-rule with the props, P. Now fix the balusters, taking care to fill up the joggles in the base and the balusters with Portland cement. The form of the joggles in the bottom end of the balusters is indicated by the dotted lines at J, and a similar joggle is shown on the top plinth and on the base. After this fix the rail-rules on the other side of the balusters, and tie both sides with the braces T, T. It will be understood that this is done at every second or third prop, or as often as may be found necessary to keep the rail-rules steady while both sides of the cornice are being run. This done, form the tile core, C, as already described, then fix the nib-rule, NR, and run the cornice. The running mould, M, is shown in position for running one side. The fine dotted surface indicates the moulding material. After both sides of the cornice are run, take off the nib-rules and the wood framing. Then finish the top and the soffit of the cornice, also the top and sides of the base, by hand, thus completing a length of balustrading.

It may here be mentioned that in practice the top plinths of the balusters are generally less in height than the bottom ones; therefore the bottom member of the cornice is so arranged that it will be below the top of the plinth, as shown by the running mould. This is constructed in this way for a twofold purpose—first, to allow a sufficient thickness of cement on the soffit of the first

row of tiles; and secondly, to form a strong bond between the cornice and the balusters. This will be seen when the bottom line of the lowest member of the cornice is carried through to the other side of the balusters, and that they are embedded about 1 inch into the soffit of the cornice.

As already mentioned, the cornice as well as the balusters are in some instances cast and then fixed on the base, which is run *in situ*. The whole of the balustrade may also be cast and then fixed *in situ*. This method is useful for additions to buildings, gardens, &c., to avoid time and dirt on the building and the adjoining work. When balustrades are cast, the dies and the half balusters on the flanks should be cast in one piece. For large work the cap of the pedestals should be cast separately, so as to decrease the weight when casting and fixing, also to give more freedom to fix the other parts of the work. "Butt" joints should be made on the caps, so as to joint with the cornice or rail on the balusters, and also on the moulding of the base of the pedestals, so as to joint with the base under the balusters. A section of a butt joint on the base of a pedestal is shown at A. The joints of the cornice and base casts should be made to come over the centre of a baluster, and joggles should be formed on the ends of both, and also on the upper surface base and the under surface of the cornice for fixing purposes. The joggles are of course made in the models before they are moulded. With different spaced balusters, as sometimes used for different works or positions, a sinking from end to end can be made in the models of the rail and base, and after the balusters are fixed the intervening sunk spaces are filled in and ruled off flush with the main surfaces. It will be seen that this method forms a continuous joggle, allowing the balusters to be fixed at any desired place, and yet have joggled fixing points on the base and rail casts.

ORNAMENTAL BALUSTERS AND PIERCED WORK.—On the introduction of Roman and similar cements balustrades composed of

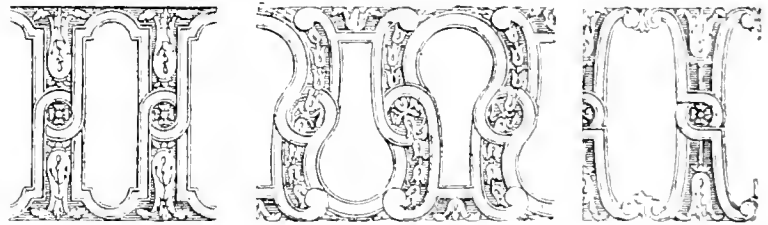

NO. 60.—THREE EXAMPLES OF PIERCED WORK FOR BALUSTRADES.

cement were largely employed in London and many provincial towns for the decoration of garden walls, balconies, terraces, house tops, &c. Designs of some of the balusters used for this purpose are shown on the appended illustration (No. 59). Fig. 1 shows an enriched double-bellied baluster; Fig. 2 is plain, and square on plan; Fig. 3 enriched, square on plan; Fig. 4 plain, octagonal on plan; Fig. 5 enriched, octagonal on plan; Figs. 6, 7, and 8 enriched, circular on plan. Balustrades are sometimes enriched with pierced work, having enriched surfaces, with a running or interlaced pattern, and are used in place of balusters. Three examples of this form of decoration are shown on illustration No. 60.

WINDOWS.—Designs somewhat similar to the windows in the annexed illustration No. 61 are often found in Portland cement façades. Fig. 1 is from St Peter's, Rome, and was designed by Michael Angelo Buonarrotti in the early part of the sixteenth century. In height the aperture is somewhat less than a double square; the architrave is one-seventh the width of the aperture, and is likewise the breadth of the pilasters; the consoles, commonly called trusses, both at top and bottom of the window, are in length one-third the width of the aperture; and the whole entablature is equal to one-quarter thereof. Fig. 2 is from the Mattei Palace at Rome, and was designed by B. Ammanati, 1569. It will be seen that the upper part is finished with a curved weathering instead of a pediment. Fig. 3 was designed by Buontalenti about 1575, and executed in different

places. The aperture of this sort of window is generally a double square; the architrave one-seventh the width of the aperture, and the pilasters about the same. The height of the whole entablature is about one-quarter the height of the aperture, and the consoles may be equal in length to half the width of the aperture at the most, and to one-third of it at the least.

When constructing these kinds of windows in Portland cement the entablature is the first part done, this being executed in the same way as described for pediments. The pilasters and architraves are generally run in one operation; from a running rule fixed on the wall for the slipper of the mould, and from a running rule fixed on the reveal of the window for the nib of the mould. A separate running mould formed without the pilaster moulding is generally required to run the horizontal part of the architrave. Wide pilasters are sometimes run from a parallel running rule fixed in the centre of the pilaster. The sill moulding is next run, then the trusses and other enrichments are fixed. The breaks in the top of the architrave, as shown in Fig. 2, are run down,

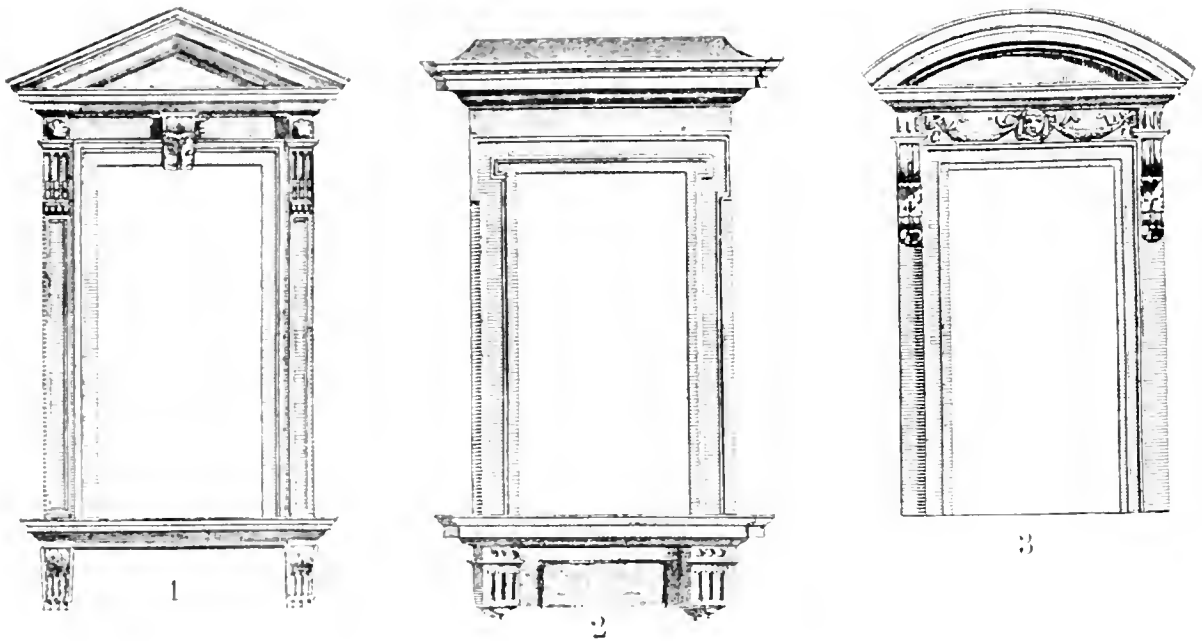

NO. 61. FORMING WINDOWS.

cut to the required lengths and mitres, then planted. It will be understood that all mitres are made while the work is "green," so as to obtain a uniform colour.

WINDOW HEAD.—The annexed illustration No. 62 shows the elevation and sections of a window in the French style. The wall is first screeded and then flanked in; then the cornice is run from a running rule fixed on the frieze at A, and a nib-rule fixed on the weathering at B. The necking moulding is run from a running rule fixed on the wall at C. The return mitres of the break are worked up by hand. The window architrave moulding can be run from a running rule fixed on the wall at D, and a nib-rule fixed on the reveal at E, and the segmental part run with a radius-rod mould, or the vertical and segmental parts can be run with a twin-slipped mould. The latter way would form the whole or a part of the reveal, and thus save screeding same. The sinkings on the wall at F are cut out of the floating, and then run so as to form a finished sinking with straight angles and arrises. The surface is fined as soon as the run parts are set. If there are a large

number of windows of the same design on the building, the shield on the window head and the enrichment in the sunk panel at the side may be cast and planted, but the swag of fruit and flowers, the spray of leaves, and the scroll ends should be modelled *in situ*. This would offer a greater variety of details, and add to general effect. If there are only a few windows in the building, the whole of the enrichments should be modelled *in situ*. It is false economy in this class of work to model, mould, cast, and plant an enrichment, when the whole could be done in one operation. The work would be equally as durable, and certainly more effective and artistic, and in most cases less expensive than cast work.

DORMER WINDOW.—Illustration No. 63 shows the elevation and sections of a side of a dormer window in a modern style. If brick is employed for the constructional work, screed the pier (A) to form a plumb ground for the mouldings. The head cornice (C) and the architrave B, are run as set forth for window heads. In this case a circular running rule is required for the

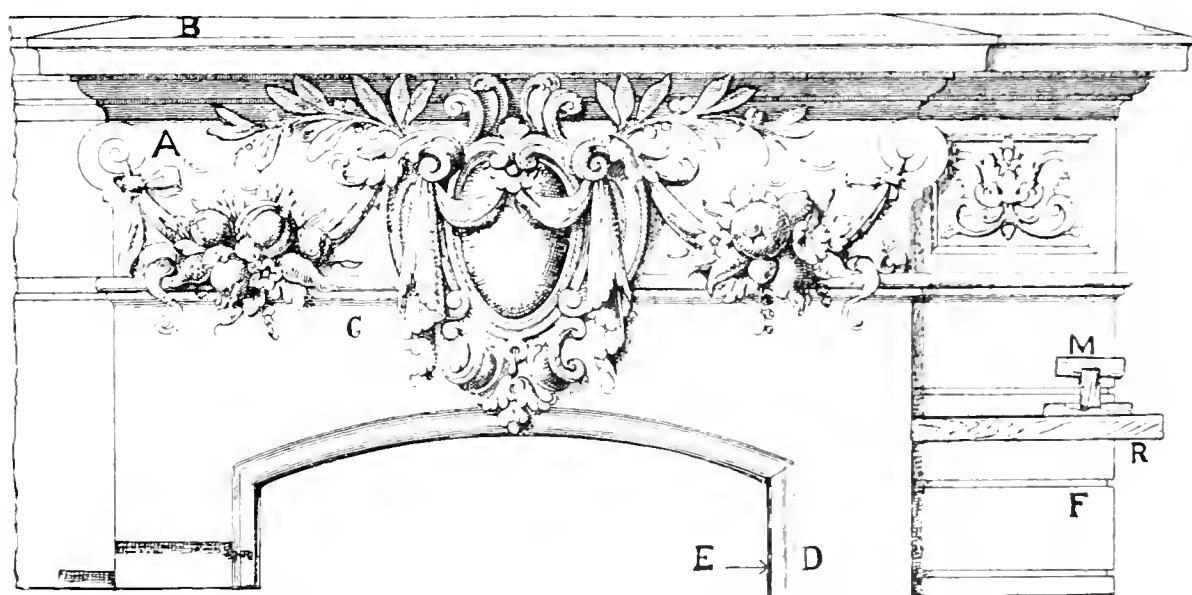

No. 62.—FORMING WINDOW HEADS.

cornice, but this and the segmental part of the architrave can be run with a radius-rod mould. The sill moulding is run from a running rule fixed on the wall at D. The band E and the outline of the scrolls at F, F, are formed by the aid of two templates which should be fixed on the side of the window, and then the intermediate space fixed in, and then ruled off flush with the templates. The outline of the apron below the window sill is formed with a template (cut to the desired curves and thickness), fixed on the wall at D. The enrichments on this and the side of the window may be either cast or modelled *in situ*; the latter for preference.

TO SET OUT AN ELIZABETHAN GABLE.—The method of setting out a gable is elucidated in illustration No. 64, and is as follows:—Let ab be the base line; bisect it in c , and erect the perpendicular line cd . From c measure to d , and draw the line ff' parallel to ab . From d measure to e , e , and f, f' ; from c measure to g , and from g , with radius gb , describe the quadrant lm . From m draw mi parallel to cd ; from f , with radius fn , describe the arc meeting the line i . Finish as shown in the left part of the sketch. The same method is adopted for setting out the

curved templates or running rules from which the mouldings are run. An allowance must be made for the width of the slipper, from the inner line of the moulding to the running edge of rule. A nib running rule must be fixed on the outer surface of the moulding, as shown at *p*, to act as a bearing for the nib of the running mould. The circular mouldings as *n i* and *m h* should be run first so as to avoid circular mitres. The circular wall rules should extend beyond the intersections, as shown at *r*, so as to allow the circular mouldings to be run right up to the mitres. It is sometimes necessary to extend the nib-rule beyond the intersection for a similar purpose. The wooden nib-rule may be extended by adding gauged plaster, and ruling it off flush with the edge of the wood portion. This circular moulding could also be run with a radius mould from the centre *g*, but as there would be no ground for a centre, as at *f*, on the actual work to run the inverted or top circular moulding, it is therefore better to run both mouldings from wall running rules as already described. The straight mouldings are next run and the mitres "put in." The wall or gable surface and the cornice weathering are then fined. A gable surface offers a fine field for effective decoration. The decoration may be formed *in situ* with modelled Portland cement, or with sgraffitto work.

ROUGH CAST. Rough cast derives its name from the fact that the material is cast, or dashed on, leaving a rough surface. In some districts it is known as "pebble dashing," and in Scotland it is called "harling." It is one of the oldest forms of external plastering. Many of the old timber houses of the Tudor and Stuart times have the spaces between the timbers filled in with rough cast. This kind of plastering is very durable, and many old examples are still to be found in good preservation. Gravel or shingle is the usual material for the surface work, but coloured glass, broken pottery, pebbles, spar, and flints have been used with good effect. The plaster for the upper coat has also been coloured where the stone has been sparsely used. By combining varied coloured stones and margins, a variety of treatment may be obtained in this description of plastering. Margins and bands may also be varied and enriched by impressing with ornamental stamps; also by stubbing with a stump or nearly worn-out birch broom. Rough cast is performed by first rendering the wall with a coat of strong-haired "coarse-stuff," and then scratching it to give a key for the second coat. This is not laid on until the first is dry. The second coat is also composed of coarse-stuff, well knocked up, and made of an even consistency. It is laid fair, and while still soft the shingle is quickly and evenly thrown or dashed on with a "scoop" or hollow trowel, then brushed with the liquid to give a uniform tint. A good craftsman can dash the shingle very regularly, and leave the face of the work with a uniform, though rough surface. The dashing should be begun at the top, gradually working down, taking in all angles and sides of panels. The gravel, shingle, or other stone, should be well washed and passed through a sieve (from $\frac{1}{4}$ -inch to $\frac{1}{2}$ -inch mesh). The shingle is then put into a tub containing hot lime hydraulic for preference and water in a semi-fluid state. This mass is well stirred, and taken out as required. Common rough cast is done on one coat of lime plaster; the shingle

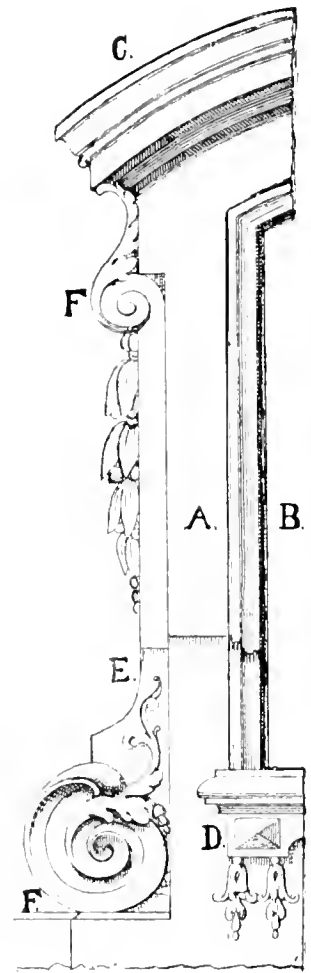

No. 63.—FORMING DORMER WINDOW.

is washed and passed through a $\frac{3}{4}$ -inch sieve and then dashed on the soft lime plaster. In some districts the walls are not plastered, the shingle mixed with thick liquid lime being simply dashed on the bare walls. For exposed positions, Portland cement may be substituted for the coarse-stuff.

DEPETER.—Depeter is similar to rough cast, and consists of forming a fair surface with coarse stuff or Portland cement. As soon as laid, a hand-float is passed over the surface a few times to give an even and uniform texture, and while it is soft, pressing in by hand small pieces of stones, broken flints, pottery, spar, glass, sea-shells, or marble. The design may be varied and enriched by using various coloured pieces in forming margins, bands, or other ornamentation. On the contrast of colours and the broad and vigorous treatment of the bands depends the effect of this class of work. A combination of depeter and rough cast may be used with good effect.

DEPRETOR.—Depretor is a term sometimes used to denote plaster finish in imitation of stone.

SGRAFFITTO.—Sgraffitto or "graffitto" is an Italian word, and means "scratched." Scratched decoration is the most ancient mode of surface decoration employed by man. The primitive savage of the flint-weapon period used this simple form of ornamentation. Scratched work, as used by prehistoric man, may be fitly termed the proem of the civilised arts of drawing, modelling, and sculpture. The term is now employed for plaster decorations, scratched or incised upon plaster or cement before it is set. It may be used for both external and internal decoration. The annexed illustrations (Nos. 65 and 66) will demonstrate the high degree to which the art of sgraffitto

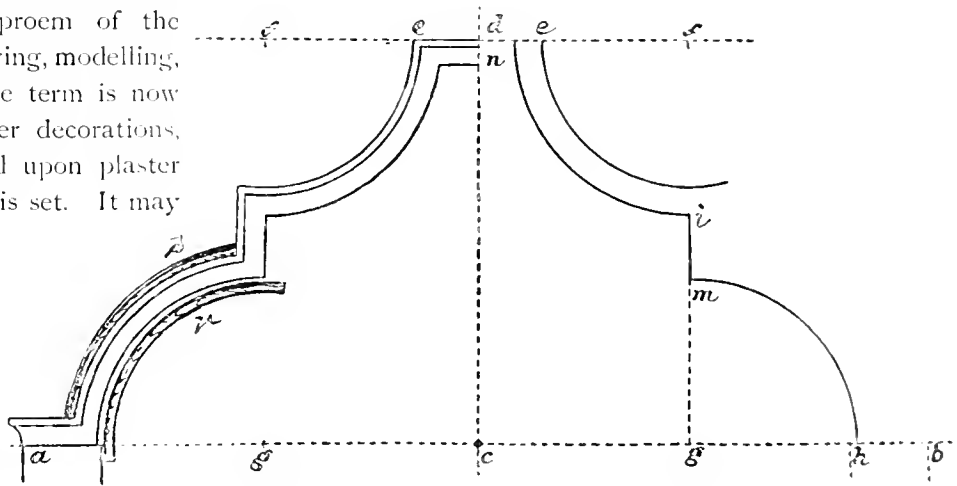

No. 64.—SETTING OUT AN ELIZABETHAN GABLE.

attained in Italy. Good English examples are to be seen at the Choir Schools of St Paul's Cathedral and the School of Music, near the Albert Hall. Different methods and materials for sgraffitto are to be seen at the Science and Arts Schools, South Kensington. This experimental work was executed by the Arts students in 1871, from designs by T. W. Moody. The work covers a large area of exterior wall surface, with a great variety of artistic designs and execution. The colours in the greater portion of the work retain their original freshness. In a few instances the colours in the panels have faded. This is probably due to the materials experimented with.

Some of the graffittos at South Kensington are really low relief work rather than sgraffitto, they being very deep cut with the iron or steel point, which was necessitated by the final coat being plastered on instead of washed on. Deep cutting gives a hard appearance to the design, prevents the water from running off the walls, and catches the dirt. In executing true sgraffitto, the cut or scratch should be exceedingly slight—in fact, in some parts scarcely perceptible. At South Kensington the work is a little darker than when first executed, still it is perfectly distinct. Time seems to have given it a finer tone.

These examples afford good evidence that sgraffitto decorations do not suffer materially from

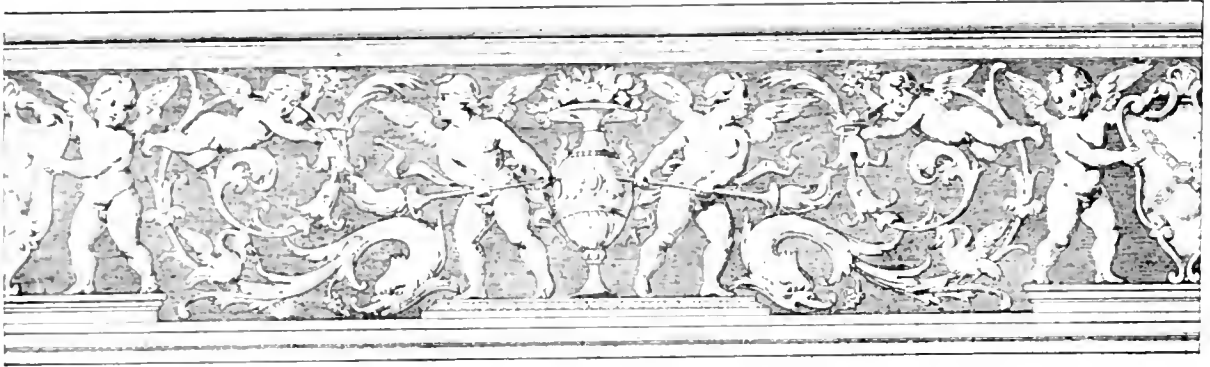

No. 65. SGRAFFITO FRIEZE FROM FLORENCE.

time and atmospheric changes. Sgraffito is extensively used on the Continent, especially in Germany and Italy. Its limited use in Great Britain is probably due to erroneous impressions that it would not resist our variable climate, and that it would prove too expensive for general use. Examples herein named tend to prove that it is a durable and inexpensive decoration. Vasari says: "Artists have another art, which is called *graffitto*. It is used to ornament the fronts of buildings, which can thus be more quickly decorated, and gives greater durability and resistance to rain, in consequence of the etching on the wall being drawn in colours. The cement is prepared and tinted, and forms the background, and is subsequently covered with a travertino lime-wash, the lines being afterwards scratched in with an iron stylus." "Backgrounds are obtained," the same author says, "by the entire removal of the surface wash," and he describes how strong projecting shadows for foliage, fruit, and grotesque figures may be obtained by adding stronger shades of the colour to the background. In some backgrounds, colours in monochrome are sometimes added, and these are treated in a similar way to fresco. This is simple after experience has taught the difference between the tint in its wet and dry state. Fine and rich effects are obtained by the addition of gilding to some of the prominent parts of the design. The gold, however, must be added when the *sgraffitto* is perfectly dry. When properly manipulated, *sgraffitto* is quite capable of resisting heat, rain, and frost, because it offers a very hard surface, and is much less porous than ordinary stones or bricks. It can also be easily washed when begrimed by smoke or fog. As to the question of cost, it will compare favourably with any other external decoration.

The beautiful examples of *sgraffitto* work, shown in the annexed illustrations (Nos. 67, 68, and 69), were designed by and executed for Mr G. T. Robinson, F.S.A. These highly artistic works should amply demonstrate and convince the most sceptical as to what can be done in this mode of decoration; also that our British artists are not behind their foreign rivals both in conception and execution.

These examples are a combination *sgraffitto* with fresco, and I cannot do better than give the *modus operandi* in the artist's own words: "In my own practice as an architect and decorator, I have, during the last fifteen or twenty years, used *sgraffitto* somewhat extensively for both external and internal adornment, and most of that which I have done is still in perfect condition, even in grimy London. The mode adopted has nothing new in it; in fact, Vasari's instructions hold good to this day, excepting that I use ordinary materials, and find the simplest the best. The wall is prepared in the ordinary way. A rough coating of Portland, mixed with three times its quantity of good sharp sand, is, for external work, laid on and finished with a roughened surface, by

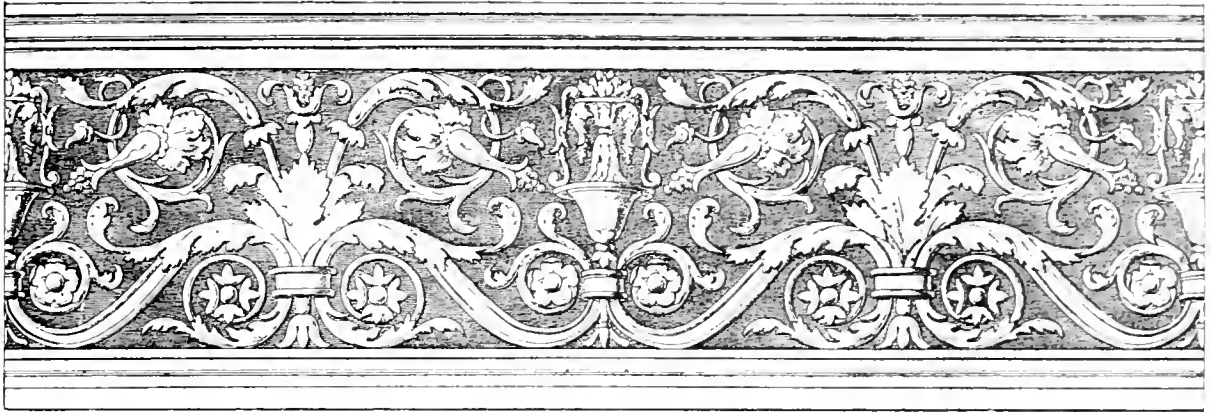

No. 66.—SGRAFFITTO FRIEZE FROM ROME.

stubbing it with an old birch besom, leaving it barely half an inch from the finished face. For internal work, the ordinary pricking up suffices. When this is dry, a thin coat of selenitic lime, mixed with the desired colouring matter for the background, is floated over it. This background may be black—bone-black being used; red, for which you may use Venetian or Indian red, or the ordinary purple brown of commerce, singly or mixed, to produce any tone you may desire; yellow, produced by ochres or umbers; blue, by German blue, Antwerp blue, or any of the commoner blues, avoiding cobalt, and these colours you may use to any degree of intensity or paleness. When this coat is nearly dry, you skim over it a very thin coat of pure selenitic lime, which dries of a parchment colour, and generally suffices. If you want a pure white lime, use a moderate quick-setting one, as stiff as you can work it, and as each variety of lime has its own individual perversity, I can give no general direction, and would advise the beginner to stick to selenitic, which is always procurable. You have, of course, prepared your cartoon. This is pricked and pounced as for any other transfer process, and then with an old, well-worn, big-bladed knife, for there is no better tool, you can cut round all the outlines, and with a flat spatula clear away all the thin upper coat, leaving the coloured ground as smooth as you can. If your plaster is not quite dry enough for the two coats to separate easily, wait a little longer, but not too long, for that is fatal. By the time you have cleared out your background, the plaster will be in a good condition to allow you to cut out the finer parts of the design, such as the folds of the draperies, or the finer lines of the faces or of the ornament. Use your knife slightly on the slope, and if you want to produce half-tones, slope it very much; but, as a rule, the more you avoid half-tones, and the simpler and purer your line, the more effective your work will be. Recollect, above all things, you are making a design and not a picture, and you must never hesitate, for to retouch is impossible. Sometimes it may be desirable to gild the background, and you can then carve or impress it with any design you choose. It occasionally happens you want to give some semblance of pictorial character to your work when it is small in scale and near the eye, and then you can proceed as though you were cutting a wood-block. The series of the Four Seasons in a porch at Maidenhead (illustrations Nos. 67, 68 illustrate this treatment.)

“By cutting out your ground colour in places, and plastering it with that of another colour, you may vary any portion of it you desire. You can also wash over certain parts of your upper coat with a water-colour if you desire, combining fresco with the sgraffitto, both of which manners

are used in the Southport retable illustration No. 69; but, as a rule, the broader your design, and the simpler your treatment of it, the better. It will be seen that this process is very available for simple architectonic effects; and for churches, hospitals, and other places where large surfaces have to be covered, it is the least costly process that can be adopted. It has also the great advantage of being non-absorbent, and it can be washed down at any time. At Messrs Trollope's establishment in London there is a specimen which for two years was fixed up outside their heating apparatus chimney, exposed to all weathers, under the adverse circumstances of rapid changes of temperature, and it was naturally encrusted with soot. It has simply been washed, and presents a very fair illustration



SPRING.



SUMMER.



AUTUMN.



WINTER.

Nos. 67 AND 68. SGRAFFITO PANELS. THE FOUR SEASONS. BY G. T. ROBINSON, F.S.A.

of how enduring this mode of decoration is, and how well fitted for external decoration of town buildings. The artist is untrammelled by difficulties of execution, but he should bear in mind that the more carefully he draws his lines, and the simpler he keeps his composition, the more charmed with the process he will be, and the better will be the effect of his work."

Mr Heywood Sumner, a well-known artist, records his experience of sgraffitto as follows:— "Rake and sweep out the mortar joints, then give the wall as much water as it will drink, or it will absorb the moisture from the coarse coat, as it will not set, but merely dry, in which case it will be worth little more than dry mud. Care should be taken that the cement and sand which compose

the coarse coat should be properly gauged, or there may be an unequal suction for the finishing coats. The surface of the coarse coat should be well roughened to give a good key, and it should stand some days to thoroughly set before laying the finishing coats. When sufficiently set, fix your cartoon in its destined position with nails; pounce through the pricked outline; remove the cartoon; replace the nails in the register holes; mark in with chalk spaces for the different colours, as indicated by the pounced impression on the coarse coat; lay the several colours of the colour coat according to the design as shown by the chalk outlines; take care that in doing so the register nails are not displaced; roughen the face in order to make a good key for the final coat. When set, follow on with the final surface coat, only laying as much as can be cut and cleaned up in a day. When this is sufficiently steady, fix up the cartoon in its registered position; pounce through the pricked outline; remove the cartoon, and cut the design in the surface coat before it sets; then



No. 69.—RETABLE AT SOUTHPORT. BY G. T. ROBINSON, F.S.A.

if the register is correct, cut through to different colours, according to the design, and in the course of a few days the work should set as hard and as homogeneous as stone, and as damp-proof as the nature of things permits.

“When cleaning up the ground of colour which may be exposed, care should be taken to obtain a similar quantity of surface all through the work, so as to get a broad effect of deliberate and calculated contrast between the trowelled surface of the final coat and the scraped surface of the colour coat. The manner of design should be founded upon a frank acceptance of line, and upon simple contrasts of light against dark, or dark against light. The following are the proportions of the various coats :—

“Coarse coat—1 of Portland cement to 3 of washed sharp coarse sand.

“Colour coat—1½ of air-slaked Portland to 1 of colour laid ¼ inch thick. Distemper colours are Indian red, Turkey red, ochre, umber, lime blue; lime blue and ochre for green; oxide of man-

ganese for black. In using lime blue, its violet hue may be overcome by adding a little ochre. It should be noted that it sets much quicker and harder than the other colours named.

"Final coat, internal work—Parian, air-slaked for twenty-four hours to retard its setting, or Aberthaw lime and selenitic sifted through a fine sieve.

"For external work—3 selenitic and 2 silver sand.

"When finishing, space out the wall according to the scheme of decoration, and decide where to begin, and give the wall in such place as much water as it will drink; then lay the colour coat, and leave sufficient key for the final coat. Calculate how much surface of colour coat it may be advisable to get on to the wall, as it is better to maintain throughout the work the same duration of time between the laying of the colour coat and the following on with the final surface coat; for this reason, that if the colour sets hard before laying the final coat, it is impossible to get up the colour to its full strength wherever it may be revealed in the scratching of the decoration. When the colour coat is quite firm, and all shine has passed away from its surface, follow on with the final coat, but only lay as much as can be finished in one day. The final coat is trowelled up, and the design is incised or scratched out. Individual taste and experience must decide as to thickness of final coat, but if laid between $\frac{1}{4}$ inch and $\frac{1}{2}$ inch, and the lines cut with slanting edges, a side light gives emphasis to the finished result, making the outlines tell alternately as they take the light or cast a shadow."

Another method which I have used in sgraffitto for external decoration was done entirely with Portland cement. This material for strap-work or broad foliage, or where minuteness of detail is unnecessary, will be found suitable for many places and positions. Three colours may be used if required, such as black for the background, red for the middle coat, and grey or white for the final coat. These colours may be varied and substituted for each other as desired, or as the design dictates. The Portland cement for floating can be made black by using black smithy ashes as an aggregate, and by gauging with black manganese if for a thin coat. The red is obtained by adding from 5 to 10 per cent. of red oxide, the white by gauging the cement with white marble dust, or with whiting or lime, the grey being the natural colour of the cement. After the first coat is laid, it is keyed with a coarse broom. The second coat is laid fair and left moderately rough with a hand-float. The suction of the first coat will give sufficient firmness to allow the third coat to be laid on without disturbing the second. The third coat should be laid before the second is set hard. The second and third coats may be used neat, or gauged with fine sifted aggregate as required. The finer the stuff, the easier and cleaner the work, and the cut lines are more accurate and free from jagged edges. The outlines of the design may be pounced or otherwise transferred to the surface of the work, and the details put in by hand. The thickness of the second coat should be about $\frac{1}{8}$ inch, and the third coat about $\frac{1}{4}$ inch. The thickness of one or both coats may be varied to suit the design. The beauty of effect of this method of linear decoration, aided by two or three colours, depends greatly on the treatment of design, the clearness of the incised lines, and the pleasing colour contrasts. It will be seen that in the three methods described there is a similarity, yet the method of using two colour coats on a dark floating coat will give more variety and effect. There is a large use for sgraffitto in the future, as it has been in the past, and its use is intimately bound up with the future of cement concrete.

In order that the foregoing examples of high-class sgraffitto may not deter the young plasterer from trying his "prentice han'" in this class of work, some simple designs are given in the annexed illustration (No. 70). Fig. 1 shows a design for a frieze in two colours. The ground may be black or red, and the ornament buff or grey. The coloured material for the ornament is laid first, and the

coloured material for the ground laid last. Fig. 2 shows a design for a cove in two colours, one with two shades. The ground is grey, and the band work buff. A deeper shade of buff for the honeysuckle can be obtained by brushing this part with liquid colour made deeper than the original gauge, also by laying a black coat first, and in a line with the honeysuckle; then laying the buff stuff for the band work next, and then laying the grey colour last. In the latter case the honeysuckle is cut deeper than the band work, so as to expose the black coat.

The annexed illustration (No. 71) shows a design of an ornament with mitre for a panel moulding in two colours, the ground black and the ornament red. The red colour is laid first, and the black next. Other colours may be substituted as required. Illustration No. 72 shows a design for a frieze or a panel ornament in three colours with shading tints. The first ground (1) is dark brown, the second ground (2) buff, and the fleur-de-lis leaf work (3) white or a light grey. The paterae and balls are also white or grey, with a black ground. The band work is the same colour as No. 2 ground. This may be tinted a darker shade by brushing it with a darker solution than used for the ground. Different effects can be obtained by changing the colours. Sections of the surface of the frieze and part of the moulding are shown at the ends.

Designs for sgraffitto borders are depicted in the annexed illustrations (Nos. 73 and 74). These designs are bold and effective, and are composed in two colours.

FRESCO.—The plasterer is closely allied to the artist painter. He has always to be in readiness to plaster the wall for the artist. Owing to the alliance with distinguished artists, and the various methods of preparing and using the plaster materials, I am induced to give a few notes,

also extracts from writers of authority. Fresco is a mode of painting with water-colours on freshly laid plaster while it remains naturally wet. The colours incorporate with the plaster, and drying with it, the work becomes very durable. It is called "fresco" either because it was originally used on buildings in the open air, or because it was done on fresh plaster. Fresco is an ancient art, being mentioned by Pliny. Mr Flinders Petrie found some remarkably fine specimens on floors and walls at Tel-el-Amarna, which reveal the state of the art 3,300 years ago. Fine frescoes were discovered in the ruins of Pompeii. In one of the principal houses the plaster walls are adorned with theatrical scenes; in an inner room is the niche often to be seen in Pompeian houses. The frescoes on the walls consist of floral dados. Above this is a whole aquarium, with shells, plants, birds, and animals. They are all executed in their natural colours, and are naturally and gracefully drawn. Michael Angelo's beautiful fresco on the ceiling of the Sistine Chapel in the Vatican is grand both in conception and execution. It measures 133 feet in length by 43 feet in width

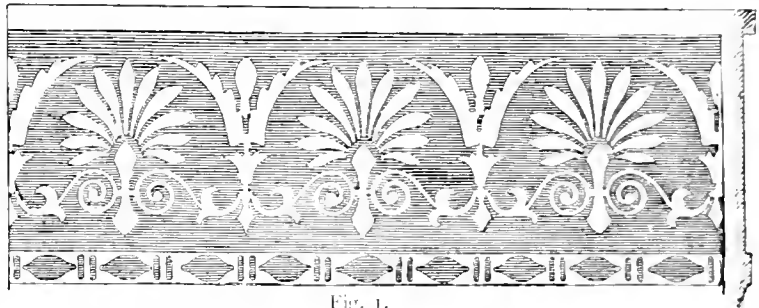

Fig. 1.

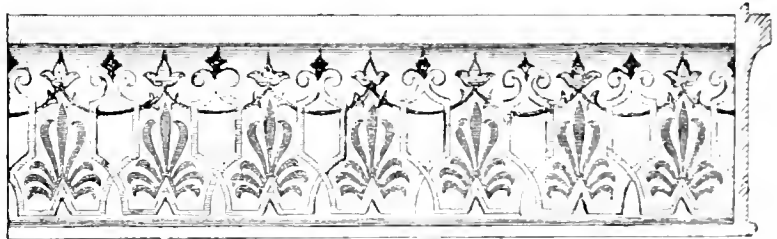
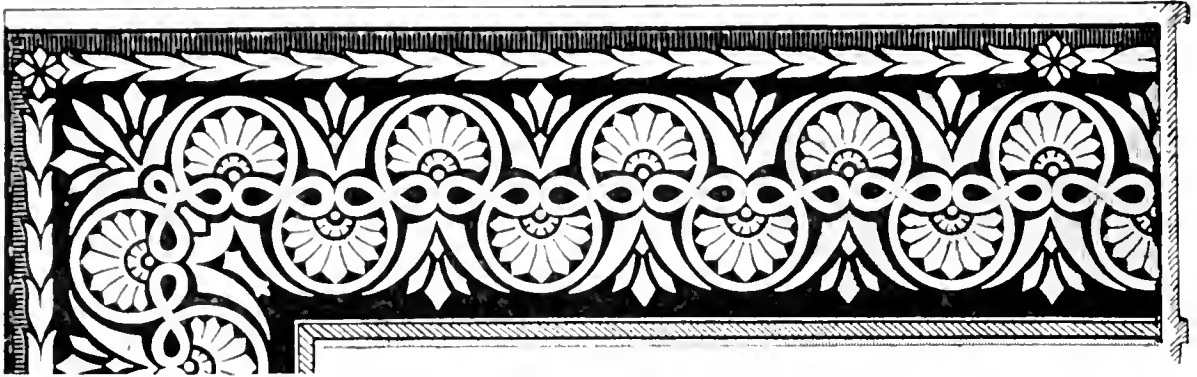

Fig. 2.

NO. 70.—SGRAFFITTO FRIEZE IN TWO COLOURS.



NO. 71.—SCRAFFILLO FRIEZE IN TWO COLOURS.

Raphael's frescoes in the Vatican, Farnesina Palace, &c., are wonderfully fine, and may be regarded as the high-water mark of Cinque Cento decoration. Raphael was assisted by Giovanni da Udine and Giulio Romano, who were also artists in stucco. There are two large frescoes by Maclise (each 45 feet long and 12 feet high) in the House of Lords. The fine frescoes recently executed by Sir Frederick Leighton, in the South Kensington Museum, are admired by all classes of art lovers: The annexed illustration (No. 75) shows part of a ceiling (the centre panel is fresco), taken from a design by M. Ch. Liénard.

For fresco or *buon fresco* the lime has to be carefully run, and the sand should be white, clean, and of even grain, being well washed and sifted to free it from impurities or saline properties. Silver sand is preferred by some artists. The older the putty lime, the better the results. The lime is slaked in a tub, and then run through a fine wire sieve into a tank, and after being covered up, is left for three months. It is then put into the tub again, and re-slaked, or rather well worked, and run through a fine hair sieve into earthenware jars or slate tanks, and the water which collects at the top drawn or poured off, the jars or tanks being covered over to exclude the air. Lime putty in this state will keep for an indefinite time without injury. A large quantity of old putty for fresco purposes is, or was lately, kept in the cellars of the Houses of Parliament. The proportions of the putty and sand will vary somewhat according to the circumstances and (particularly) according to the quality of the lime. From 2 to 4 parts of sand to 1 part putty is usual. Marble dust alone is sometimes used in place of sand, and also with sand in equal parts. Every difference of lime and sand found in various localities should be considered and tested before using. A soft sand is quickly dissolved by a strong lime, and a plaster made of this is fit for use sooner, and will deteriorate more quickly, than a plaster made with a less powerful lime and a harder sand, or with marble dust.

The wall surface to be plastered must be well scraped and hacked, the joints raked out and brushed, and the whole surface well scrubbed and wetted. The rendering is done with the best possible prepared old coarse stuff. If the walls are rough or uneven, they should be first pricked up, and then floated. In any case, the surface is left true, and with a rough face, to receive the finishing coat. Portland cement or hydraulic lime gauged with sand, also gauged with coarse stuff, has been used where the walls were damp (damp is fatal to fresco), or if exposed to the atmosphere. When Portland cement or hydraulic lime is used, the work should be allowed to stand until thoroughly dry to allow any contained soluble saline efflorescence to come to the surface. This is brushed off with a dry brush, and a few days are allowed to elapse to see if there is a further

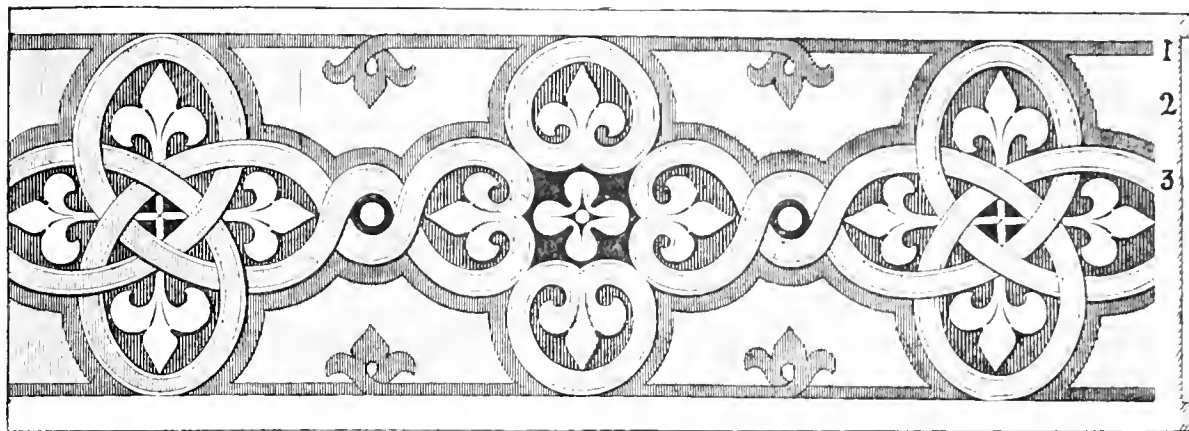

NO. 72.—SGRAFFITTO FRIEZE IN THREE MAIN COLOURS AND SHADING TINTS.

efflorescence. When this is all extracted and swept off, and the artist is ready to commence, the wall is washed with a thin solution of the fine setting stuff, and then laid about $\frac{1}{2}$ inch thick, with well-beaten, worked, and tempered fine setting stuff. It is then rubbed with a straight-edge and scoured with a hand-float (using lime water for scouring) until the surface is true and of a uniform grain. Most artists prefer a scoured surface without being trowelled. No more surface should be covered than can be conveniently painted in one day. While the plaster is still soft and damp, the cartoon is laid on, and the lines and details pounced in or indented by means of a bone or hard-wood tool. Should the finishing coat get too dry in any part, it can be made fit for work by using a fine spray of water. The method of plastering and the gauging of materials may slightly vary according to the desire of the painter and the kind of fresco in hand. The following is taken from an old manuscript in the Soane Museum, dated 1699:—

“1. In painting the wall to make it endure the weather, you must grind colours with lime water, milk, or whey, mixed in size.

“2. Then paste or plaster must be made of well-washed lime, mixed with powder of old rubbish stones. The lime must be often washed till finally all the salt is extracted, and all your work must be done in clear and dry weather.

“3. To make the work endure, stick into the wall stumps of headed nails, about 5 or 6 inches asunder, and by this means you may preserve the plaster from peeling.

“4. Then with the paste plaster the walls a pretty thickness, letting it dry; but scratch the first coat with the point of your trowel longways and crossways, as soon as you have done laying on what plaster or paste you think fit, that the next plastering you lay upon it may take good key, and not come off nor part from the first coat or plastering; and when the first coat is dry, plaster it over again with the thickness of half a barleycorn, very fine and smooth. Then, your colours being already prepared, work this last plastering over with the said colours in what draught or design you please—history, &c.—so will your painting unite and join fast to the plaster, and dry together as a perfect compost.

“*Note.*—Your first coat of plaster or paste must be very haired with ox-hair in it, or else your work will crack quite through the second coat of plastering, and will spoil all your painting that you paint upon the second coat of plastering; but in the second coat that is laid on of paste or plaster there must be no hair in it at all, but made thus:—Mix or temper up with well-washed lime, fine powder of old stones (called finishing stuff) and sharp grit sand, as much as you shall



No. 73.—SGRAFFITO BORDER IN TWO COLOURS.

have occasion for, to plaster over your first coat, and plaster it all very smooth and even, that no roughness, hills, nor dales, be seen, nor scratches of your trowel. The best way is to float the second coat of plastering thus:—After you have laid it all over the first coat with your trowel as even and smooth as possible, you can then take a float made of wood, very smooth, and 1 foot long and 7 or 8 inches wide, with a handle on the upper side of it to put your hand into to float your work withal, and this will make your plastering to lie even; and lastly, with your trowel you may make the said plastering as smooth as can be.

"5. In painting be nimble and free; let your work be bold and strong; but be sure to be exact, for there is no alteration after the first painting, and therefore heighten your paint enough at first; you may deepen at pleasure.

"6. All earthy colours are best, as the ochres, Spanish brown, terra-vert, and the like. Mineral colours are naught.

"7. Lastly, let your pencils and brushes be long and soft, otherwise your work will not be smooth; let your colours be full, and flow freely from the pencil or brush; and let your design be perfect at first, for in this there is no alteration to be made."

FRESCO SECCO.—Closely allied with the genuine fresco (*fresco buono*) is another kind called *fresco secco* (dry, or *mezzo* half *fresco*). The plaster work for *fresco secco* is similar to that used for *fresco buono*. It is allowed to stand until thoroughly dry. The surface is then rubbed with pumice-stone, and about twelve hours before the painting is commenced it is thoroughly wetted with water mixed with a little lime. The surface is again moistened the next morning, and the painting begun in the usual way. If the wall should become too dry, it is moistened with the aid of a syringe. There is no fear of joinings in the painting being observable, and the artist can quit or resume his work at pleasure. Joinings are distinctly noticeable in the frescos in the Loggia of the Vatican. *Fresco secco* paintings are heavy and opaque, whereas real fresco is light and transparent. While the superiority of *fresco buono* over *fresco secco* for the highest class of decorative painting is unquestionable, still the latter is suitable for many places and forms of decorative paintings. The head by Giotto in the National Gallery, from the Brancacci Chapel of the Carmine at Florence, is in *fresco secco*.

INDIAN FRESCO AND MARBLE PLASTER.—"Fresco painting is a common mode of decoration



No. 74.—SGRAFFITO BORDER IN TWO COLOURS.

in Jeypore, and is used in ornamenting walls inside and outside of buildings—also as a dado or border round the wainscot or on the floor—and on any surface where decoration is desired. The beautiful marble plaster on which it is done is common in Rajputana, and is used to line the surface of walls or floors, and of baths or bath-rooms. It is admirably adapted to places where coolness and cleanliness are desired, and is very suitable to a warm climate. It would no doubt be more commonly used if pure lime could be obtained.

“To prepare the marble plaster, the process in use in Jeypore is as follows:—Take pure stone lime, mix it with water until it has dissolved, then strain it through a fine cloth. In Jeypore the lime is made from pounded marble chips or almost pure limestone. The substance which remains in the cloth is called *bujra*, and all that passes through the cloth is called *ghole*. These should be prepared a few days before they are required so as to allow time to settle, and every day the water should be changed, so as to leave a very fine sediment.

“*Jinki*, which is also used, is pure marble ground to a very fine dry powder; *kurra* is a mixture of *bujra* and *jinki*; and *jinkera* is a mixture of *ghole* and *kurra*. These are the materials used, and the names by which they are known in Jeypore. In Madras, where similar plaster is used, it is made, I believe, from shells, and the ingredients are probably known by other local names.

“If the surface to be polished is a slab or stone, the *kurra* mixture consists of 1 part by weight of *bujra* and $1\frac{1}{2}$ parts of *jinki*. If the surface is a wall or a *chunam* floor, it must be first thoroughly dry and consolidated—then take equal parts of *bujra* and *jinki* to form the *kurra* mixture. Mix the *bujra* and the *jinki* well together; add a little water, and grind them well together, in the same way as natives mix their condiments, by hand with a stone rolling-pin on a slab, until they form a perfectly fine paste. Wet the surface which is to be polished, and spread over it a layer of this *kurra* mixture, about $\frac{1}{8}$ inch thick. Then beat the surface gently with a flat wooden beater, sprinkling a few drops of clean water on the surface occasionally. Then mix a little *ghole* with the *kurra* plaster (described above as *jinkera*) and lay it on evenly with a brush as if it were a coat of paint; rub the surface over carefully with any close-grained flat stone, called in Jeypore *ghaon*. The object of this is to smooth down all irregularity and roughness, and to prepare a smooth even surface. Sprinkle a few drops of water and repeat the process, taking care that no hollow places are allowed to remain. Paint it over with fine *jinkera* (*ghole* and *kurra* mixed), increasing the

proportion of ghole, and rub it down well with a flat stone (jhaon) as before; then paint it over with ghole only, after each coat rubbing it down carefully with the (jhaon) stone. After this, rub it all over with a soft linen cloth, called in Jeypore *nainsukh*, folded into a pad. Then give it another coat of ghole, and now rub it down carefully with a piece of polished agate, called in Jeypore *ghunti*, until it begins to shine. The surface must not be allowed to dry too rapidly, or a good polish will not be obtained. Care must be taken that the lime has been thoroughly slaked in the first instance, or it may blister; also that the surface, if a floor, is thoroughly consolidated, as the least settlement naturally causes the plaster to crack. The polishing process with the agate cannot



NO. 75.—PLASTER CEILING (ONE QUARTER), CENTRE PANEL FRESCO—MODERN.

be repeated too often; the more it is carefully done, the better will be the polish. Every time the agate is moved backwards it should be made to pass over a portion of its previous course, so as to prevent any mark or line at the edge. Lastly, if the surface is to remain white, take some water which has been mixed with grated cocoanut, and lay it on the surface. Let it dry, and then rub it down with a fine cloth folded into a pad. If any colouring is desired, the same process is adopted until the polishing with the agate is begun. This is only done slightly. If any pattern is desired, it is drawn on paper and pricked out. The paper is placed on the surface, and is dusted with very

finely powdered charcoal tied up in a muslin bag. The charcoal passes through the perforations and marks the plaster surface. The paints are mixed with water, and are painted on by hand while the surface is still fresh and moist, hence the term fresco. Where a large surface has to be done, it is necessary to employ several men to work at the same time, in order that the surface may be all painted before it has time to dry; or else the pattern must be so arranged that the connection of one day's work with the work of the next will not be amiss. Immediately after the surface has been painted, the colours are beaten in with the back of a small trowel, in such a manner that the colour is not rubbed or mixed with the colour adjacent. As soon as it shows to the touch that the colour has become incorporated with the plaster, the surface is painted over with water mixed with grated cocoanut, and is then polished down with the agate.

"The following colours can be used in this process:—Lamp black; red lead; green (from a stone known as *hava pathar*); yellow (from a stone called *pila pathar*); brown or chocolate. A little glue is mixed with the two first colours, and gum only with the others. The colours used are mostly earths or minerals, as others will not stand the action of the lime. Vegetable pigments cannot be used for this mode of painting, even when mixed with mineral pigments, and of the latter only those are available which resist the chemical action of lime. The lime in drying throws out a kind of crystal surface which protects the colour and imparts a degree of clearness superior to that of any work in tempera or size paint. The process, although apparently simple, requires dexterity and certainty of hand, for the surface of the plaster is delicate, and the lime only imbibes a certain quantity of additional moisture in the form of liquid colours, after which it loses its crystallising quality, and the surface or a portion of it becomes rotten. It is only after the lime has dried that such flaws are discovered, and the only remedy is to cut away the defective portion, lay on fresh plaster, and do the work over again. The colours become lighter after the plaster dries, so allowance must be made for this. The advantages which this process possesses are clearness, exhibiting the colours in a pure and bright state; the surface is not dull and dry as in tempera or size painting, nor glossy as in oil painting; it can be easily seen from any point, and it is not injured by exposure to the air; it will stand washing, and can be cleaned with water without injury."*

IMPRESSED PLASTER WORK.—Under the title of "Producing Ornamental Plastering or Stucco Work," a patent was obtained in 1856 by Benjamin Ferry, architect, London. This invention consists of indenting or impressing ornamental patterns on plaster surfaces as the work proceeds. For this purpose ornamental pattern plates are formed with the pattern cut through them similar to stencil plates. The plates are made of metal, their thickness depending on the depth of the desired impression. The edge of the pattern is splayed so as not only to enter more freely into the plaster, but also that the impressing plates may come from the impression produced without injury to the impression plate in the first instance, but only to impress the plates into the surface, and then after similarly impressing the other contiguous parts in like manner, to return to the parts first impressed in order to deepen the impression. In pressing the ornamenting perforated plates into the soft and plastic surfaces, the workmen should give the plates a tremulous motion, by which not only will the act of pressing the ornamenting plates into the soft surfaces be facilitated, but the plates will be found more readily to leave the impressions without injuring the sharpness of the edges of the parts in relief. It will be evident that in place of pressing the perforated plates into the plastic surfaces after they have been laid on, the parts in relief may be applied through the perforated ornamenting plates, whilst the parts below are in a moist or plastic state, in which case the parts in relief may, if desired, be of a different colour to the sunk parts.

* The foregoing is from the *R.I.B.A. Journal*, under the title of "Fresco Painting, as practised in Jeypore, Rajputana," by Colonel S. S. Jacob, Engineer to the Jeypore State.

CHAPTER VIII.

MODELLING.

THE PRINCIPLES OF MODELLING—FIGURE MODELLING—PORTRAITURE—NATURALISTIC AND CONVENTIONAL STYLES—THE MODELLER'S ART—MODELLING *IN SITU*—HAND WORK—MODELLER'S SHOP—MODELLING TOOLS—MODELLING CLAY—PLASTHINA—PATE PLASTIQUE—MATERIALS FOR BUSTS—CLAY MODELLING—CEILING AND WALL DECORATION IN MODELLED PLASTER—METHOD OF MODELLING *IN SITU*—MATERIALS FOR MODELLED PLASTER—MODELLING IN CEMENT—WAX MODELLING—MODELLING WAX, BEESWAX—MODELLING IN TOW—ARCHITECTURAL MODEL MAKING.

THE PRINCIPLES OF MODELLING.—Modelling is a very ancient art. According to some authors, it was first applied to the ornamentation of the knobs on the covers for vases made many centuries before the Christian era. Lucian describes Diogenes' tub as being one of these jars or vases with knobs. The late Dr Schliemann considered that several of the modelled terra-cotta vases found by him at Troy were over ten thousand years old. Such dates are of course open to discussion, but Dr Flinders Petrie's discoveries conclusively prove that the art of modelling plaster was well known more than three thousand years ago. In the Book of Kings we read that when Solomon built the Temple he sent for Hiram of Tyre and his workers in brass, and that they cast two pillars of molten brass, which were enriched with lilies and pomegranates. Homer mentions the Phœnicians as being skillful artists; but it was under Phidias, the Athenian, and the Attic School of the time of Pericles, that art attained its highest point; and from this time, 460 B.C., to the capture of Corinth by the Romans, sculpture bore off the palm. All these facts prove that modelling, with its attendants, moulding and casting, was worked in great perfection in the early ages.

Modelling is the most simple and direct method of acquiring a due sense of form and proportion. It is the best method of expressing form, as it deals with the third dimension, that is, projection, as well as length and breadth. The art of drawing is the twin sister of modelling.

To the man who aspires to be a good workman, foreman, modeller, or master-man, a knowledge of drawing is most essential. It enables him to read a drawing, or to make one if required. For the young shop-hand who is desirous of becoming a modeller, still harder study is required. A knowledge of the various styles of architecture is highly important. Another desirable acquisition is a thorough grounding in the anatomy of the human figure. The proper study of the human figure has not had the attention from the British workman that it deserves. Mr Burgess, an acknowledged authority on decorative art, says: "The third impediment to our progress is the want of a more extended teaching of the figure. Up to very lately there seems to have been great reluctance in almost every profession connected with the fine arts—except in those of painting and sculpture—to teach pupils the human figure. So important, indeed, is this acquisition of the power of drawing from the human figure, that there is scarcely a trade or profession where the designer or artisan would not find it of the very greatest assistance; and even in architecture, which to a certain degree would seem independent of it, except as an accessory, it is the only way of giving the pupil that power of judgment which is generally called good taste." Some one has

said that the man who could draw a head could draw a leaf, but that it by no means followed that a man who could draw a leaf could draw a head.

Plasterers should avail themselves of the many opportunities now to be had in the form of evening classes at Art Schools and Technical Institutes which most towns however small possess to learn freehand, modelling, perspective drawing, and geometry, which are great helps to all classes of workmen. After the rudiments have been surmounted, the practice of drawing will become not only a help, but a real and lasting pleasure. To be able to draw makes a man feel more confident in his own abilities than the man who does such wonderful work at the bar or tap-room of the public-house. Some men are apparently very clever in drawing with their finger in spilt beer wonderful mouldings, telling how they were run and mitred, and how they ran diminished and elliptic mouldings by the mile; but on being put to the test, the abilities of these same clever men diminish as fast as the beer drank overnight. I am glad to say this is the exception, not the rule, though many of my readers will doubtless be able to recall similar cases in their own districts.

FIGURE MODELLING.—In the following remarks as to figure modelling, it is assumed that the modeller has acquired command of the pencil, and is able to express his ideas as to form by means of drawings. To acquire a thorough knowledge, the student should copy from casts, from nature, or the antique. He should also study anatomy. A ready knowledge of figure form and anatomy enables one to know what to aim at and what to avoid when modelling any of the innumerable attitudes that the human figure can be made to assume. The study of anatomy quickens perception and improves the memory, because, as Haydon said, "When the mind is thoroughly informed of the means beneath the skin, the eye instantly comprehends the hints above it."

The annexed illustration No. 76 of the anatomical figure shows the superficial muscles. A cast of the anatomical figure and a cast of Hercules or of the fighting gladiator are excellent models to copy from. The bones and muscles should be drawn and modelled in various positions. Their sizes at different periods of life should also be drawn and measured. The balance of the figure should be preserved. The centre of gravity will be found in a vertical line dropped from the little hollow at the top of the breast-bone.

In well-proportioned figures the length of the body from foot to head is divisible into $7\frac{1}{2}$ or 8 parts, each equal to a head. The widest part across the shoulders equals two heads in man, and a head and a half in woman. The widest part across the hips equals a head and a half in man, and two heads in woman. From shoulder to elbow equals one head and a quarter, and from elbow to wrist one head and a quarter. From the sole of the foot to the knee, and from the knee to the muscle at the side, and from this muscle to the shoulders, are about equal. If the arms be fully extended, the distance from the tip of the middle finger of one hand to that of the other will be equal to the height of the figure. The hand is equal in length to the foot, and the foot is about equal to one-sixth of the figure. The female head is smaller than that of the male. The height of the head is divisible into four equal parts, which are the space from the chin to the nose, the nose to the eye, the eye to the forehead, and from the forehead to the upper part of the head. The width of the head across the eyes is equal to five eyes, and the space between the eyes equal to one,



NO. 76.—ANATOMICAL FIGURE.

The bottom of the lower lip is slightly above the middle of the lowest division of the face, and the lower lip has greater fulness than the upper. The width of the nostrils is about equal to the length of an eye, and the width of the mouth to the length of an eye and a half. The ear is placed in the back half of the head, and equals the length of the nose, with which it is on a level. The body is proportionately longer in the child than in the adult. The head of the child is larger than in adults compared with the rest of the body. The head and face of the human figure expresses the general character, the principal points of expression lying in the outer angles of the mouth and the inner angles of the eyes and eyebrows.

The above rules are used by many artists of repute; but although common, they are by no means infallible, as the proportions vary according to the age, sex, character, and race of the model. Commence by copying from the best procurable models. For original subjects, copy from life

models. Drapery should be arranged on "lay figures," and these used as models to copy from. The subjoined illustration No. 77 of the Venus of Milo, the original of which now stands in the Louvre, is one of the finest productions of Greek art. This shows the perfection of the human form, and also shows a fine example of drapery.



NO. 77.—VENUS OF MILO.

A knowledge of mythology is an acquisition to a modeller, especially if he has to design. There is a story told of a man, who, on being requested to enrich a panel with "Flora," innocently inquired, "Flora who?" On being told that Flora was the goddess of flowers, he concluded that it was the figure of the florist's wife that was wanted. A modeller should also be conversant with allegorical subjects. A curious request was once made by an embryo designer. He was desired to enrich a keystone with the head of Father Thames, on which he remarked that he did not know the gentleman—could he get a likeness to copy from?

PORTRAITURE.—Portraiture is the art of producing a likeness of people and animals in any suitable material. To some it may appear that figure work and portraiture belong to the higher art of sculpture, and are beyond the powers of a decorative modeller; but if one looks at the many excellent terra-cotta figure panels, medallions, and plastic decorations that now adorn many mansions, it will be seen that modellers have made and are making rapid strides in figure work. Mr G. Tinworth is a remarkable

instance of a successful modeller. He is the moving art spirit at Messrs Doulton's Potteries, and his many beautiful bas-reliefs and statues are to be found in all parts of the world. The importance of a knowledge of the human figure has already been pointed out, and as a knowledge of portraiture is a necessary adjunct, careful study and ample practice may bring to light some embryo Flaxman or Michael Angelo. It is assumed that the modeller has mastered all the rudiments of figure drawing and modelling before he attempts portraiture. When modelling a bust, support the clay with a wooden upright and a cross piece, and tie a piece of leaden pipe at the top end to allow the head to be bent or turned to any desired position. A bust support is shown on page 233. The original and the clay model should be on the same plane, so that the modeller will not have to look down to one and up to the other. The model can be raised or lowered as

required by the aid of a modelling stool, as shown on page 233. Begin the modelling by building up with clay, using the fingers freely, and occasionally a rough serrated tool to form the outline. After the work is roughly blocked out, the calipers may be used for testing the actual measurements with the original. If projections are too small, add more clay; and if too great, work them down with a serrated tool. Constantly view the original and the model from various points, and compare the forms. View the back as well as the front and sides. This will enable many imperfections of contour at the sides to be observed that are not perceptible from the front. Study well the proportion of one part to another, for without a cultivated sense of proportion, artistic success will be difficult to attain. At this stage the model may be left for a day to firm, but not dry. It should be covered with a damp cloth or an oilskin to keep it plastic. Clean all tools, and put the surplus clay in the clay box. On resuming the work, it is probable that previous undetected defects will be observed. After correcting the defects and verifying the proportion with the calipers, the details are next proceeded with. Avoid reproducing every crease of the skin, but define the features in detail, portraying every peculiarity and characteristic without exaggeration, and embody every effect or action which constitutes the expression. Great skill is required in finishing the skin so as not to lose the drawing of the surface. The hair should be broadly massed, using but few thin lines. The drapery is left less smooth than the skin, but more so than the hair. Various ways are used for producing texture surfaces. Coarse lines may be obliterated by using a wet cloth or sponge, and by pressing the thumb in parts. The same tool must not be used for both flesh and drapery. Texture is to a model what the marks of the brush are to a painting. In the drapery, great attention must be paid to the folds. Every fold necessitates a ridge and a groove. Parallel folds should be avoided; curved ones have breaks, which give variety. Triangular forms in drapery are always pleasing, so are key folds, as formed when two folds meet and unite in one ridge. As a rule, flat drapery is more effective than round folds. A good model for drapery is obtained by the use of wet linen or by dry and soft woollen cloth. Drapery for the full figure is a great test of the modeller's power, and he should first copy from the antique, and then from nature. It has been aptly said that a clay model is in a transitory state, in plaster it is life, and in marble it becomes immortal.

NATURALISTIC AND CONVENTIONAL STYLES.—In decorative or ornamental art there are two schools which strive for pre-eminence, viz., the naturalistic and the conventional. Each has its admirers and students. An eminent authority on decorative art says: "True ornament does not consist in the mere imitation of natural objects, but rather in the adaptation of their peculiar beauties of form and colour to decorative purposes, controlled by the nature of the material to be decorated, the laws of art and the necessities of manufacturing, and civilised tastes." Another writer of great discrimination says: "From the labours of ornamentists united to the common search after novelty at any sacrifice of true taste, for which manufacturers are so constantly urging, there has arisen a new species of ornament of the most objectionable kind, which it is desirable at once to deprecate, on account of its complete departure from just and true principles. This may be called the natural, or merely imitative style, and is seen in its worst development in some of the articles of form. Thus we have metal imitations of plants and flowers, with an attempt to make them a strict resemblance of a thing, rather than to imitate it. This is the case with fine art also. In its highest effort mere imitation is an error and an impertinence, and true ornamental art is even more opposed to the merely imitative treatment now so largely adopted. Let any one examine a floral or foliated ornament produced in metal by electrotyping the natural object, whereby every venation and striation of the plant is reproduced, and compare it with a well and simply modelled treatment, where only the general features of the form are given, and all the minutest details

purposely omitted, and if this latter has been done with a true sense of the characteristics of the plant, the meanness and littleness of the one mode will be perfectly evident compared with the larger manner of the other." An important point in designing and modelling is unity and appropriateness of the design. It is the fitness or suitability for a given place that makes the whole an appropriate decoration.

THE MODELLER'S ART.—The thanks of all interested in plastic art are due to those architects who insist on having their designs specially modelled, instead of choosing from the (in some cases) poor selection of the plasterer's stock of models. I have seen ornaments of various styles introduced into one cornice, but happily such cases are rare. Another detriment to the employment of modellers, and consequently to the art, is that the master plasterer is allowed to retain the originals, not for reference, but for use again and again, and often without regard to style, height of room, form of the members of the cornice, &c., but simply because it happens to be near the size of the space to be enriched. It is not fair to the proprietor who builds a mansion, or to the architect who has caused special designs to be modelled, to afterwards find them reproduced in some public-house, or in a common speculative, jerry-built edifice. Some architects insert a proviso in their specifications that the originals shall be broken up after the completion of the job, or bind the plasterer down not to remould the originals for further use. Sometimes architects and surveyors, when selecting ornaments, or choosing models in a plasterer's or modeller's shop, judge them as they appear lying on a bench, without thinking of the height or position they are intended to occupy, the amount of light that will bear upon them, or how they will harmonise with the other enrichments and members of the cornice. About eighteen years ago an addition was built to the National Gallery, where I was employed on the modelling. Mr E. M. Barry, R.A., the eminent architect, had about 6 feet of the cornice in each of the various galleries run in its proper position, and the various enrichments fixed. A portion of the scaffold was cleared away in order that the effect of the cornice might be seen from the floor. The late Sir Digby Wyatt adopted the same plan before giving the modeller a final assurance of satisfaction. Another evil is the somewhat dishonest practice, either on the part of the general contractor or the master plasterer, who, to save the expense of modelling, resort to what is generally called "cobbling"—that is, taking a bit of this, a bit of that, a bit of something else, no matter what, so that it fills up the space, and getting a shop-hand to squeeze or mould and cast the various parts of the enrichments, and put the lot together, making up a leaf here and a stem there to complete the design. The works of different modellers are often taken and mixed together, and before the various parts are joined, the design looks more like a puzzle than a decorative ornament. I have said this is done to save expense, but it is very questionable if it does so, and it is probably a more costly process. Some employers think if a cheap man can make something like the required enrichment, he will effect a saving; but if he were to reckon his own time and that of the shopman looking for the different originals required, and squeezing or moulding and casting, then cutting and filling, and the plaster wasted, I think the balance of cost would be in favour of employing a good modeller, and also that the work when finished would be far more satisfactory from an artistic as well as from a pecuniary point of view.

Another plan adopted in some shops, especially where there is a stock of old metal, wood, or plaster piece moulds, is to choose a mould having a scroll, swag, leaf, head, &c., or what may be required to make up a given design, and to fill in the parts required with paste composition. The compo casts are then mounted on a ground, and being of a more elastic nature than a plaster cast they lend more freedom for bending the stems, scrolls, &c., to the required curves. The colour of the compo is nearly the same as clay, therefore the work when submitted for the architect's

approval appears as if expressly modelled. The *compo* being fixed with soft *compo* or needle points, can easily be altered as required.

Many modellers have begun as shop-hands, and some have worked on the scaffold. In my plastic experience, after three years in the shop, casting, moulding, and modelling, I have known what it is to use the "broadsword" (big laying trowel), do a week's stretch of first-coating, floating, run mouldings, and fix wet ornaments on a cold raw morning, but I have found my building experience of great advantage in subsequent shop-work and modelling. If all men are not able to be "sons of clay," there is still a pleasure in knowing how it is done, and in being able to tell when it is done well. A knowledge of shop-work is very useful to a scaffold or building plasterer, more especially to a man employed on ornamental work. It enables him to fix ornament with neatness, and work up the mitres of enrichments with taste and despatch. The father of John Flaxman, the world-renowned sculptor, was a modeller and plasterer. Flaxman in his early days designed and modelled for Wedgwood. His first model in wax was produced at the Royal Academy in 1770.

An artist is a workman. The converse should also hold good; but how seldom does it happen that the workman is an artist? A good man approaches his work with true artistic feeling. To do it badly or roughly inspires him with a sense of shame, such as a true man feels when he has unwittingly been drawn into or mixed up with a mean or dishonourable action. The whole tendency of the age is towards gain, veneer, and underselling, which is not favourable to honest work or workmen, or to the development of artistic feeling. It is only when a man begins to put his heart in his work that he has pleasure in doing it, and produces satisfactory results. Fiammingo was elevated by the production of his beautiful models. Benvenuto Cellini took a pride in his gorgeous vases. Palissy, the potter, delighted in his rare productions. Flaxman felt a glow of satisfaction over his superb and graceful sculptures. Luca della Robbia revelled over his exquisite wax, clay, and plaster models, and Wedgwood was proud of the famous ware that bears his name. And so with all other great art workmen, because of the great beauty, the openings for form and taste, the exercise of fancy, and the expression of feeling in all their works.

MODELLING "IN SITU."—Modelling work done *in situ* affords a happy medium to enable the architect to relieve the plainness of the structure (internal or external), without waiting for the sometimes slow process of moulding, casting, and fixing, in addition to the actual modelling. Modelling *in situ* can be done on stone, brick, wood, or iron work. The tenacity of the modern cements enables the work to be done on any surface, however smooth. The materials can be coloured, or afterwards painted to match or harmonise with any colour. There is always the advantage of knowing that *in situ* work will not be reproduced *ad libitum* by jerry-builders, who often obtain copies of the models at unfair prices and by unjust means. Work done *in situ* enables the modeller to use his eye and reason. He can exercise both to judge the effect in actual position. He can also get better effects with less ornamental detail. This method of formation produces more artistic work, and a greater variety of design. With a little practice with the material, it is just as easy to model in cement or stucco as in clay, and the result is absolutely your own work. It is as easy for a modeller to do work *in situ* as it is for a carver—in fact, the modeller has the advantage that he can add as well as subtract. This method of modelling would give an impetus to the art and craft. Many portions of work that are generally done in the shop might with advantage be done *in situ*. This would avoid repetition. Small enrichments which are essentially repetitive, because they form an outline of a member, may be modelled, moulded, cast, and fixed, and in some instances be repeated. The evil and want of taste is in repeating the portions which were specially designed for one particular place and purpose, and using them inappropriately. When

modellers and plasterers throw off their present apathy, and study their craft more carefully and artistically, there will doubtless be a large future for modelling *in situ*.

HAND WORK.—The origin of plaster work is lost in antiquity. It is known to have been largely used in ancient Greece, in temples such as that of Apollo at Delos, and in the ancient Parthenon. The ancient decorative plaster work unearthed in Rome, Pompeii, and the Italo-Greek tombs of Magna Græcia, show how extensively it was used, and to what perfection its decorative uses had attained. All this work is exclusively hand-modelled. Professor Aitchison, A.R.A., has said that "the most beautiful ornamental plastering he has ever seen was in a vaulted chamber of Hadrian's Villa, . . . and it appeared to have been entirely modelled by hand. . . . Such work had the charm of variety which cast plaster never possessed." It is generally believed that the ancient method of executing decorative plaster work was that of modelling entirely in the soft plaster *in situ*. It is more probable that the general method was a combination of cast work (and possibly stamped work) with hand work. The main ornament was cast and fixed, while the minor foliage were subsequently modelled. The leading ornament may also have been stamped *in situ*, and the subordinate sprays and leaves worked up by hand. Running patterns were made by pressing moulds or stamps on the stuff while soft to form the general outlines. The work was then undercut and finished by hand. Plasterers of old used wood, lead, and resin moulds.

Hand work is simply modelling direct with stucco, cement, or plaster. The work may be done *in situ* or on slabs, and then fixed. The art of hand work in the past had a wider range than at present, when all the ornamental work was done by hand, executed in the freest manner in soft plaster, and with excellent effect on the walls and ceilings of which they form the decorations. These examples of the skill of the worker in plaster may well, in their happy and free effect, bear witness to the easy and natural appearance of which this mode of working is capable. It is a regrettable fact that this beautiful mode of artistic decoration has fallen into disuse; but architectural fashion, like history, repeats itself, and when a higher sense of duty in relation to art arises among those able to encourage this charming plastic art, it will be revived, and become permanent and pleasing. The numerous foreign examples mentioned by Mr G. T. Robinson, and the photographs of ancient works, abundantly prove its durability. The illustrations in this work will show that the old hand work was artistic as well as durable. The question of cost is greatly in favour of hand work. Materials are cheap, and it is quicker than modelling in clay, and then moulding, casting, and fixing the casts. It is, in fact, as easy to model in stucco, cement, or plaster, as in clay, and the work has all the merits of originals, not dull cast work repeated *ad nauseam*, but each separate part instinct with fresh life and vigour. Even if hand work does cost somewhat more than cast work, the client has the satisfaction of knowing that it is his own copyright, and that he will not be annoyed by finding it repeated in jerry buildings. Casts of new modelled work are sometimes obtained by taskmasters from some peccant plasterer in want of a job, and who has been at work where the casts were first used. Happily such instances are rare.

Among the few works done by hand in the present day may be mentioned the Swan Hotel, Chelsea, and Mr Holt's house, and the works of Messrs Ernest George & Peto. Another modern example of stamped and hand work is Mr Colcut's quaintly designed façade in Fleet Street. Mr Walter Crane is an artistic exponent of hand-worked plastic art. Mr G. T. Robinson executed a large hunting scene in stucco on the gables of a building at Cowdray, near Midhurst, for Lord Egmont. I have had some little experience in plastic hand work, notably at the Baynard Castle Hotel, Queen Victoria Street, London, built 1874. The whole of the front, with the exception of some small coats of arms, about 9 inches by 5 inches, was worked up by hand *in situ*. The materials

used were Portland cement, lime putty, and sand, in the proportions of 5 parts of cement, 2 parts of putty, and 2 parts of sand. These were mixed together, and then coloured by adding yellow ochre and Indian red to imitate terra-cotta. A curious fact in relation to this part of the work is that it was actually sketched and described by a leading technical journal as terra-cotta. The building was designed by Mr Almond, architect, and the drawings for the ornamental work were made by E. Robbins from old engravings. A portion of this work is shown on the annexed illustration (No. 78). The only difficulty in working this rough material was to keep the forms somewhat

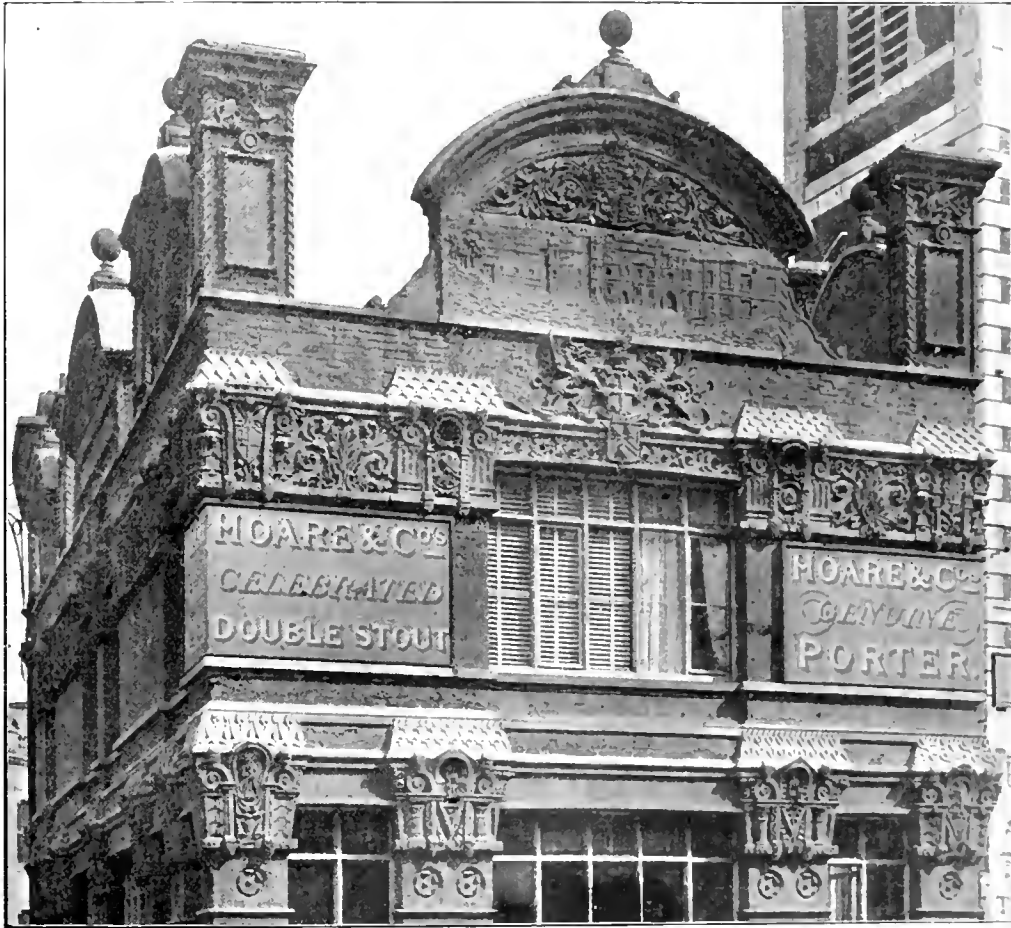

NO. 78.—EXTERIOR ORNAMENTATION IN PORTLAND CEMENT, MODELLED *in situ* BY W. MILLAR, 1874.
BAYNARD CASTLE HOTEL, LONDON.

crude to be in accordance with the originals. In an upper panel there is a perspective view of the original Baynard Castle done on a cement ground $\frac{1}{2}$ inch thick. I am doubtful as to the durability of this work, as the lime used in combination with the Portland cement was quite new, in fact, hot when used. The new lime may cause excessive expansion or blowing in the cement, and lead to fractures, in the future. In my opinion the brick work was insufficiently keyed to retain the ornamentation, which may affect its stability. Being only engaged to do the modelling, I had no voice in the selection of the materials; this and the method of keying the surface was under the sole

direction of E. Robbins, the foreman plasterer. I am pleased to state that several of the plasterers who were employed running the moulding also assisted in laying on the stuff and cutting out various parts of the decorated surface, and also displayed an apt ability in modelling some of the minor work, among whom may be mentioned J. Wilson and O. Cullen. Mr G. Vulliamy, the city architect, had the supervision of the whole building. Excellent examples of hand work are to be seen at the Grafton Galleries. A portion of this work is shown on the annexed illustration No. 79. This shows a frieze about 5 feet high, modelled *in situ* by C. Giddings for Gilbert Seale in 1892, Messrs Wimperis & Arber being the architects. A stumbling-block in the way of this art becoming more popular is due to the want of a little humility on the part of the modellers in donning a blouse, and working on the scaffold. The artists of old, men of genius and talent, who worked in plastic art, were not afraid or ashamed of their work or their blouse. The greatest artists of the present day wear them. Sir Frederick Leighton and other English artists wear a common painter's blouse when engaged on decorative work, and absolutely do the work with their own hands. Therefore labour of this kind really ennobles a man, and his blouse is a garb of honour to him.

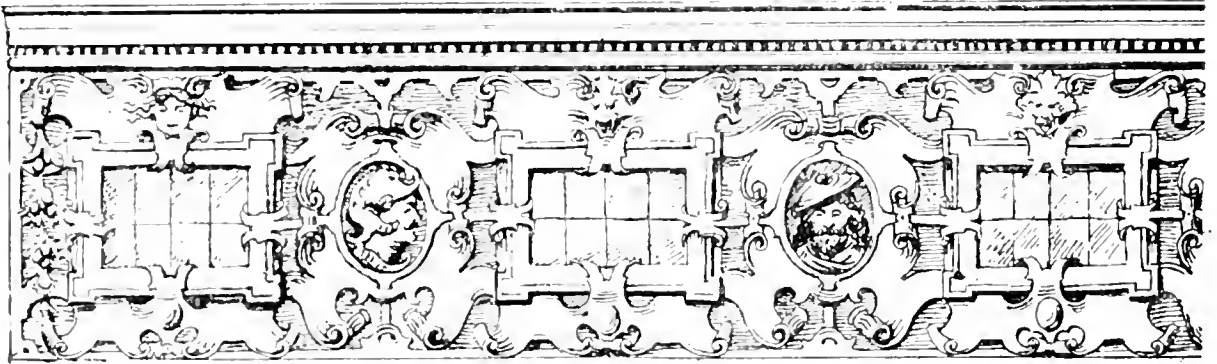

NO. 79. FRIEZE MODELLED *in situ*. GRAFTON GALLERIES, LONDON, 1892.

MODELLING SHOP.—The modelling shop should be high, and lighted from the north or east. A roof light falling at an angle of 45° is best. If this is not procurable, have a large side light. When gas is used, it should be on a movable upright, with a long flexible rubber pipe. A modelling stand is required. This is about 3 feet 6 inches high, and has a movable top, which revolves on a pin. Some are made with fixed tops, and a turnbat laid on the top, so that the model can be turned round as required. Another kind, chiefly used for modelling busts, is made with a screw running up inside the stand, so that it can be elevated or lowered at will, as shown in illustration No. 80. Illustration No. 81 shows a bust support, being the method of forming internal support as used when modelling busts. The upright piece in the form of a cross is fixed to the lower or modelling board. A piece of flexible metal tubing is tied on to the top of the upright. The flexible tubing allows the head of the bust to be moved if required to obtain any desired pose. The bust support is placed on the modelling stool, and the whole is then raised and lowered as required. Turnbats are made with two round boards, each about 1 inch thick, and from 12 to 16 inches diameter. The top revolves on a pin which is fixed in the lower board; it should turn smoothly on metal rollers let in near the edge, or between two zinc plates well greased.

Modelling boards, and slate slabs for modelling flat surfaces, are necessary; also concrete clay tanks to keep the clay clean and moist. Pieces of unbleached calico are required for keeping clay models moist. A looking-glass is useful to facilitate the comparison of the effect of the work. It is held up over the work, and the effect can be seen by looking in the glass. An easel for supporting modelling and drawing boards is useful. Casts of heads and the human figure from the antique and modern sculptors, such as Flaxman, should be hung up for reference purposes. There should also be choice bits of fruit, flowers, and foliage, from the works of eminent masters of the art of modelling, and also casts from nature. The work of modellers is often subjected to the pert criticism of certain classes of visitors. The following sentence which I have seen somewhere in a corner of the Quartier Latin, Paris, called the "Artists' Quarter," might with advantage be written over the door of the modelling shops—"Carpere facilius est quam imitare" (It is easier to criticise than imitate).

MODELLING TOOLS.—Modelling tools are usually made of boxwood. Pear-tree and bone

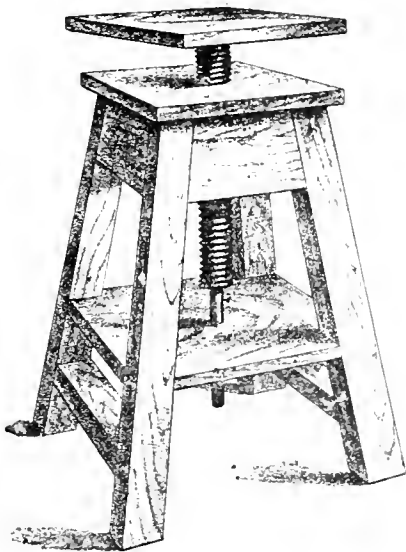

No. 80.—MODELLING STOOL.

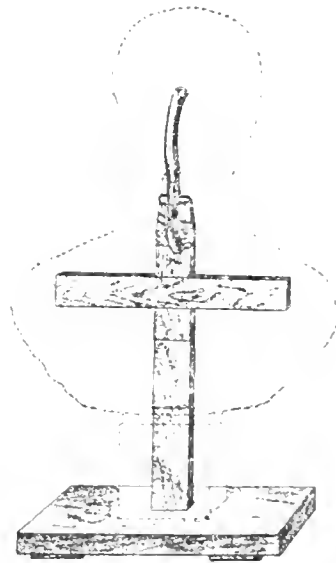

No. 81.—BUST SUPPORT.

are also employed. They vary in length from 7 to 9 inches. Some are plain on edge, and others are serrated, yet others have the ends shaped like finger points. Some of the most useful forms are exhibited in the annexed illustration (No. 82). The best tools for modelling are those made by the user. Good tools for small work are made from the handles of old tooth brushes. I have seen Tom Garland (who thirty years ago was called the Father of Modellers) produce very effective work with one or two sticks from a halfpenny bundle of wood; but I do not recommend novices to try this form of tool. Another useful and effective tool for modelling is the wire tool. This is made out of a thick brass or copper wire, flattened and bent to the desired shape. It is then fastened on a boxwood handle with brass wire. Wire tools are made in various shapes and sizes. The principal forms are as exhibited on the annexed illustration (No. 83).

Steel tools are occasionally used for clay modelling. They are, however, more adapted for modelling in plaster and tow, also for cleaning up plaster models. Some modellers use brass tools for modelling, but no material is so well adapted for this purpose as the wood and wire tools herein

described. Do not forget that nature provides those that are most efficient and principally used, viz., the fingers.

Compasses and calipers are also required. A basin for clean water and a sponge should be at hand for keeping the fingers and the tools clean. A plumb-bob and a foot-rule will be found useful. Adjustable calipers, as shown on illustration No. 84, are useful for enlarging and reducing models. They can be made of hardwood or steel. They are made with a movable centre, so that the proportion between the points at the minor end *c* can be altered as regards the major end *b*.

Some modellers require fewer tools than others. In connection with this I may mention that during the Belt and Lawes furore, I was engaged giving entertainments at the Theatre Royal, Bradford, and other places, modelling busts of the Prince of Wales, and sometimes men selected from the audience, *à la* "Belt." For this purpose I only used a wire clay cutter, one modelling tool, and the fingers and thumbs, occasionally using both hands so as to balance the most prominent

parts on each side more readily. A modelling stool was placed on the stage, and two or three blocks of clay placed on the top of the stool, and then I proceeded with the modelling of the bust. The wire clay cutter was used for reducing the clay to the profile, and the modelling tool and fingers for the details.

MODELLING CLAY.—

Clay is generally used for modelling. It is easily manipulated and kept moist with moderate attention. It can be procured in balls or in bulk ready for use at most pottery works. If kept clean

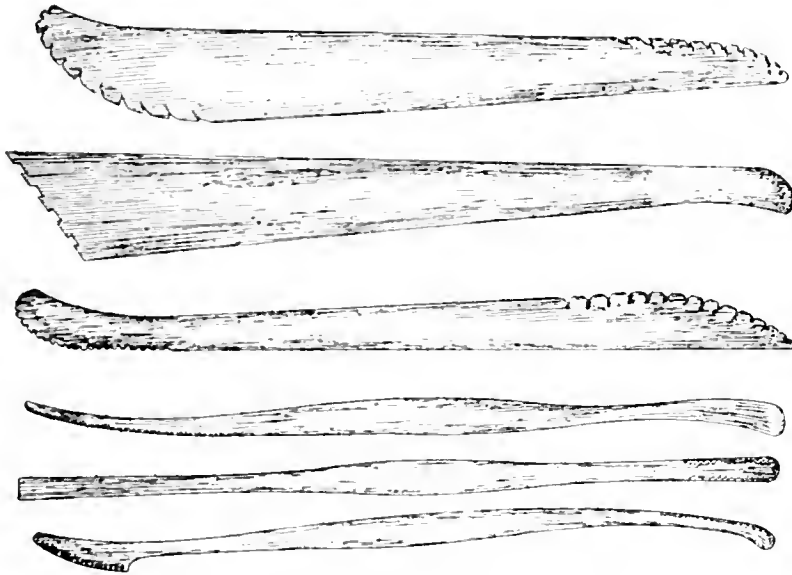

No. 82.—WOOD MODELLING TOOLS.

and free from oil and waste plaster, it can be used over and over again for different models. The more it is beaten and tempered, the freer it works. New clay is spongy, and is liable to shrink and crack. It should not be allowed to dry, or it will become hard, and involve much labour to make it fit for use again. Some sculptors prefer clay mixed with a little fine sand to give it more grip. Modelling clay is chiefly got at Newton Abbot, Devonshire. There are seventy balls to a ton.

PLASTILINA.—Several methods have been tried to render clay indefinitely moist and plastic. Oil, turpentine, vaseline, and glycerine have been used as substitutes for part of the water. Oil clay does not work so freely as water clay. "Plastilina" is a modelling material invented by Senor Giudici, of Genoa. It looks and works like clay, but has a strong odour. It will not leave the hands without using soda or Hudson's soap in cold water, but it will dissolve with ordinary soap in hot water. It will not hurt the skin, but care must be taken to prevent its coming in contact with the eyes.

"PATE PLASTIQUE" is another modelling material which is used by Parisian modellers. It is the same as modelling wax, and is made in various colours. It works freely and clean to the fingers. Plaster, gauged with glue water to retard the setting, is prepared by some sculptors for large work. The groups in front of the Trocadero, in Paris, by Falgniere; also the Quadriga, temporarily placed on the Arc de Triomphe, were modelled in this material. Mr Watts modelled his great statue of Hugh Lupus, for Eaton Hall, in plaster. A small sketch model in clay or wax to scale is first made, then the large framework is made on wood or iron supports. On this a foundation of lath-work or canvas dipped in plaster is formed. The whole is then covered with a rough coat of plaster. The work is then modelled in the glue-gauged plaster, and a pleasing finish is obtained by using flat brushes.

MATERIALS FOR BUSTS.—Superfine plaster is the usual material for casting busts and medallions. Superfine Parian cement is an excellent material for casting busts.

It is stronger and more marble-like than plaster. Of course it requires greater care and attention than plaster when casting, but this is amply repaid by the results. I modelled a bust of the Prince of Wales from photographs, and reproduced it in Parian cement. The bust was exhibited in the Bradford Technical School Exhibition in 1882, and excited some curiosity among the craft. As regards the material, it had the touch and appearance of real statuary marble. Plaster casts, coloured to imitate terra-cotta, look better and last longer than white plaster casts. Yellow ochre

and purple brown are mixed with the gauging water to obtain the desired terra-cotta tints. A marble appearance is obtained by gauging ground glass with fine plaster. This gives the lustre and sparkle of real marble. For other materials, see "Recipes."

CLAY MODELLING.—Clay modelling is a seductive art. When once begun, it is not easily left off. It educates the hand and the eye, and greatly quickens the

perception. Man can express his ideas better with clay than with chalk and pencil. But for artistic purposes it is useless to attempt modelling without a knowledge of drawing. Modelling may be described as raised drawing, and to those who can draw the work will be easier and come more naturally. Having acquired freedom with the pencil, the novice may begin with clay. Some simple leaf may be copied; first the same size, and then a size and a half larger. Keep on copying to give confidence, freedom, and a grip of the clay, using nature's tools, the fingers, to add the clay when

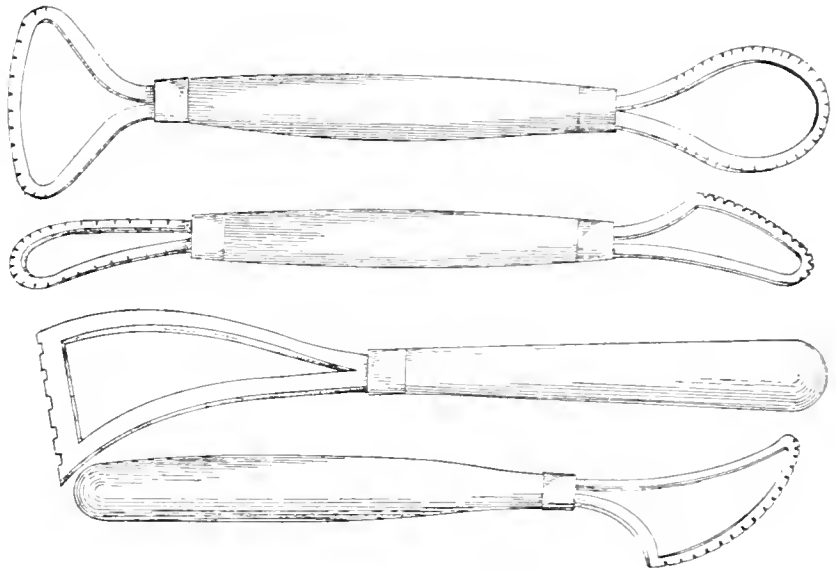

No. 83.—WIRE MODELLING TOOLS.

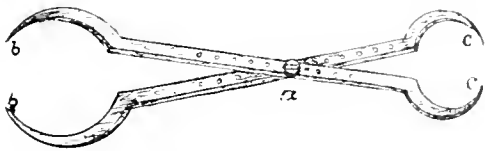

No. 84.—ADJUSTABLE CALIPERS.

required. Never begin to put in detail or finish until the whole is blocked out, and proved correct in size and proportion. Fine details and smooth finish are of secondary consideration. When the eye is unable to judge and correct size, contour, and proportion, use calipers and compasses, but use them as little as possible in order to train the eye. Practice alone will enable the student to detect and correct errors and irregularities in lines, contours, and points. When errors are detected, they must be effaced in a bold and decisive manner. If the errors are numerous, the work should be begun over again, avoiding the previous errors. This is better than correcting a mass of mistakes. The work should be gone over again and again, doing a little here and a little there, and stepping back to judge the effect from different positions. Constantly viewing the work too near or from one point accustoms the eye to defects. The first portions of the work must be proved with the calipers, and the effect with a mirror. Many defects will be seen when reversed in the glass. When the work is correctly blocked out, the finishing may be begun, but no attempt should be made to finish one part to the neglect of others. Too much detail or overfinish should not be put into the work. A sketch model has greater charms than a smooth surface full of littleness. The rough zigzag strokes which occur in unfinished sketches, whether drawn or modelled, have an artistic effect. When a high finish is attempted, the work looks mechanical and hard. Fine finished surfaces may be used for small repeated enrichments, or where fine painting or gilding has to be applied, especially if the gilding is to be burnished. Plaster having a fine natural texture, the casts gradually assume a smoother surface than the rough original. This is also caused by the surface of the mould wearing smooth or blunt by repeated friction when casting. The reverse also occurs if the moulding and casting is improperly done, and the moulds and the casts become rougher with every successive cast. The opposite effects of fine finish and texture will be seen by taking a cast from a finely carved stone. Although the plaster cast may have a smooth surface, the general details will look coarse and the effects toned down when compared with the stone. The novice should never be too ambitious, or attempt large or important subjects, before having fully mastered minor and simple ones, and the rudiments of the art. Modelling, like the art of music, cannot be learned until the scales have been mastered and committed to memory.

When ornamentation is near and subject to close inspection every part of the work should be fully expressed and well finished, but when it is exalted the details should be slightly touched, as it is sufficient if the general form be distinct and the principal features well developed. A few rough strokes from a skillful hand are much more effectual than the most elaborate finishing of an artless imitator. Smoothing and neatly rounding off the parts destroy rather than produce effect. It is necessary that craftsmen should study the ancient styles, not for reproduction, but for the knowledge to be gained in a technical way. In Schools of Art the students are frequently required to go through a course of modelling casts of the antique. The casts are generally taken from marble, stone, and wood models by past masters of the art. Casts from nature, such as fruit, flowers, leaves, &c., are also used for models to copy from. Plate XLII. depicts two panels, and illustration No. 85 a pilaster panel from Venice in the Italian Renaissance style; all are excellent subjects to draw and model.

Copying from models should be sparingly used, or the modeller may sink to the level of a mere copyist. When working from a drawing or a photograph, the modeller must exert all his ingenuity to interpret it. Obviously a model is best for a novice to copy from until he has acquired the power of form, then a drawing can be taken as a subject to increase his powers of form, and command of the materials and tools. The young aspirant should examine and study all old examples of modelling remarkable for their styles and execution.

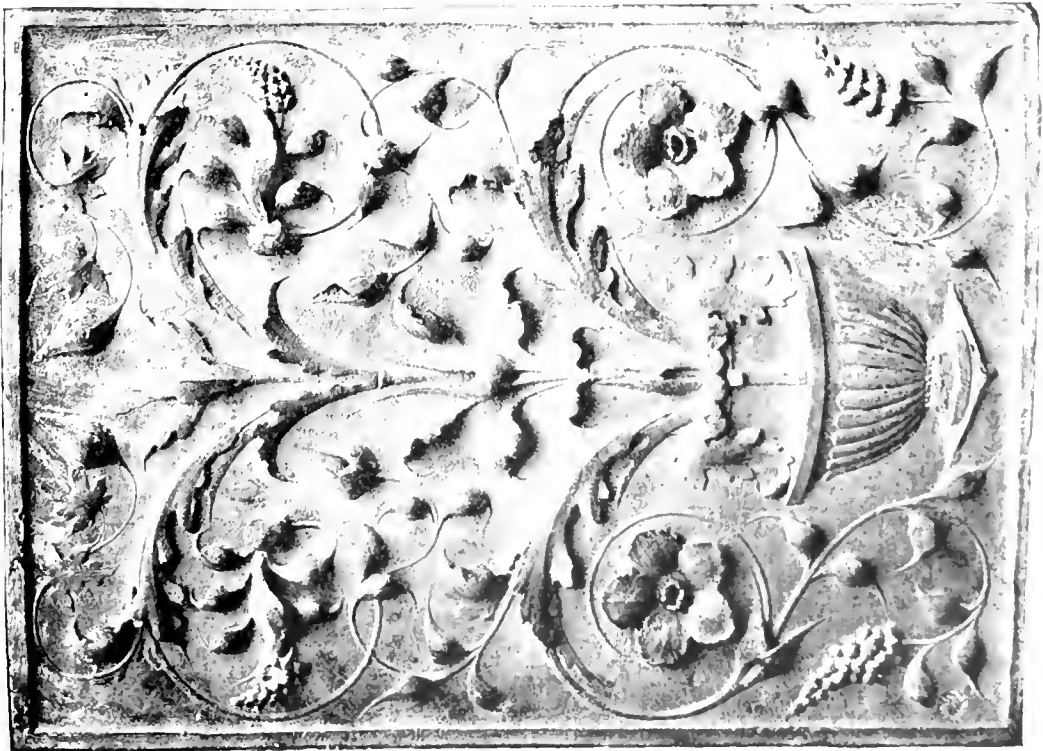



When the modelling of foliage has been acquired, parts of the human figure may be begun, copying an eye, nose, hand, or foot. The work should be copied repeatedly, only on different sizes or scales. Having mastered these details, complete heads and then figures may be tried, and then original designs. The proportions of the human figure have already been given. No man can be thought or called a modeller unless he can model the human figure. It will be seen by the numerous examples of ancient and modern works illustrated herein that the human figure (either whole or in part) is frequently employed in decoration. From antique times up to the present day half figures have been favourite subjects as caryates, persians, and as starting for ornaments, such as brackets, trusses, pilasters, &c. Two examples of these (male and female) are given as illustrations Nos. 86 and 87. The subject and main details for original decorative designs should be well thought out and committed to paper before commencing the modelling. Minor details and effects may be proceeded with while the modelling is in progress. For large subjects the cartoon is laid over the ground, and the main lines and points set out by passing over the outline with a blunt iron stylus, pressing the paper so as to leave a line sufficient as a guide. Frequently instead of the stylus the pounce bag is used, and the pricked design is pounced in red or black, as is used for sgraffito, and by the Moors for their pin-point stucco, as guides for cutting out the surface work. Even the impatient genius of Michael Angelo condescended to the pouncing process, and some of Raphael's cartoons that have been preserved are covered with pin-holes. If a plaster ground is used, the surface should be brushed with a thin solution of shellac. This hardens the surface, and gives a good grip for the clay. Clay used on a new and damp plaster ground is apt to peel, and if dry it renders the clay stiff and unworkable. The pouncing process is useful for right and left, or reversed patterns. These marks are aids for size and jointing purposes, and they save the too frequent use of the compasses. When the model is finished, the marks are easily stopped with clay or trimmed off the face of the mould. In some instances the work is modelled on a clay ground, but this does not afford a true background, and as it is difficult to joint, it should only be used where there is little or no background, or where the design is self-contained. Plaster without doubt makes the best ground for modelling, running, or repeated designs, such as soffits, friezes, &c., because it can be cut with a band or key saw, or twisted wire, at any desired place, and when the ends are reversed, this will form a true joint. Joints should be made at the sides of main stems or bands, or where they will be easy to stop, and least observable. They should on no account be made in the centre of large parts, such as main leaves, fruit, or flowers, but they may on the bed of such parts, the leaves, &c., being moulded separately, and planted so as to



NO. 85. PLASTER PANEL
FROM VENICE.

cover the joints. When modelling cornice enrichments, a sufficient length of the cornice should be run to model the various enrichments on their true beds. This also enables the harmony of all the enrichments and the plain members to be judged as a whole. The enrichments should harmonise with each other. This is effected by setting them out so that the centre or most prominent part of one will come over the centre of the one immediately beneath it, and so on with all the others.



No. 86.—TRUSS.

The largest enrichment should regulate the smaller ones. Nothing is more offensive to architectural taste than to see the centre of an egg placed over the edge of a dentil, or the main or centre stem of a leaf enrichment placed over the side band of an egg. Enrichments for panel work, or where there are numerous short lengths and mitres, should be so arranged that they will form a fair mitre. Nothing is more unworkmanlike than a clumsy mitre—for instance, to see the dart mitre with a part of the egg or the main stem of a running soffit spring from a small tendril, or the half of a leaf butt against the plain members. Good mitres and the harmonising of enrichments greatly depend upon the plasterer who makes the cast work, and unless he carefully sets the work out before fixing, the whole, however carefully modelled, will be spoilt. About thirty years ago I was at work in the modelling and moulding shops of William Cubitt, the well-known London builder. I noticed how carefully all the plaster cement, carton-pierre composition, and terra-cotta work was done. Nothing was left to chance, every part being done by the best system, and under intelligent supervision, Mr G. Baldwin being the shop foreman and Mr Willoughby the walking foreman. Mr Baldwin introduced many improve-

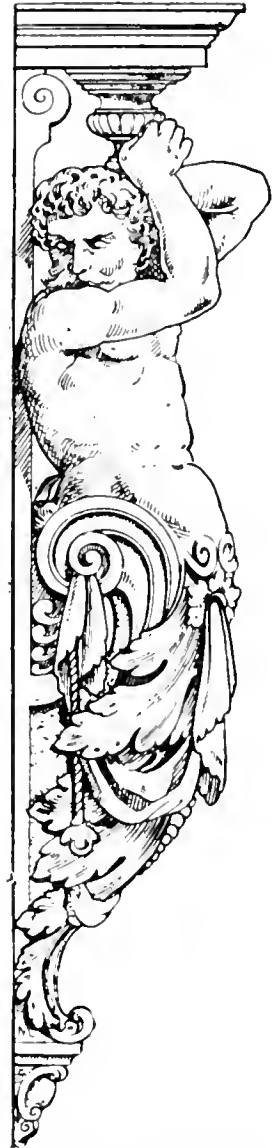

No. 87.—ORNAMENTAL PILASTER.

ments in the way of working the various parts in plaster work. Mr Willoughby was one of the old school of plasterers; and like some of the old journeymen then at work, he had a leaning towards tall hats, stiff stand-up collars, stock neckties, moleskin trousers, and blue coats with brass buttons. He was brimful of plastic knowledge. On his retirement through age he was rewarded with a handsome pension. All sub-foremen and old hands in this firm were pensioned when age over-

took them. The firm also kept a night school on the works for their apprentices, and a sick club for their men. One naturally inquires where such men and firms are now to be found. I cannot say, but would like to see similar good feelings revived between employers and employees. During the three years I was at work with this firm there were on an average five modellers, about sixty shop-hands, and two hundred scaffold plasterers regularly engaged throughout the year. It is very rare to find a plasterer's and modeller's shop in a builder's establishment affording such opportunities for acquiring a practical knowledge of the many and varied parts of plastering as was then to be found in Cubitt's. Here modelling, and model making in plaster, for plaster, cement, wood, stone, marble, metal, and terra-cotta works were constantly to be seen. Moulding in plaster, wax, and sulphur, also casting in plaster, cement, concrete, carton pierre, papier mâché, composition, and terra-cotta, also scagliola work, were in daily progress. It was the custom at Cubitt's to model mitres for all enrichments, and two lengths of the design for soffits, guilloches, and friezes, one as a shrinker and the other as a stretcher, to enable the pattern to come to a true mitre. Enrichments for short breaks or returns were set out on a bench, so as to get the external, internal, and butt mitres symmetrical. The mitres were then worked in plaster by hand, so that the main stems and scrolls should flow freely and naturally, and that the bands should finish in graceful forms. The casts were then numbered in rotation, and sent to the job ready for fixing. Large modelled surfaces intended for high positions should not be waste moulded and cleaned up. They should be moulded direct from the clay, so that the casts will bear the impress of the artist's individuality, and the artistic soft feeling which, when combined with breadth, light, and shade, gives the true effect and harmony of architectural decoration.

With regard to the use and treatment of ornamental plaster work for internal decoration, there is no material that has such strong claims. Its unique fire-resisting, sanitary, and durable qualities render it indispensable at the present time as it has been in the past. It not merely answers very many technical necessities, but tends more and more to satisfy the aesthetic sentiment by a graceful development of form in decoration; and an immense number of plastic objects exhibiting an artistic treatment in many cases of great excellence are produced in it. A large majority of them, however, are pervaded by one grave fault, a superabundance of ornament, which, covering too large a surface in proportion to the plainer parts, disturbs the impression of quiet repose and artistic harmony. The effect of the most ornamental details, and even of their most graceful arrangement, will be weakened and disturbed if they are not separated by plain surfaces of some extent, simple profiles, and great bold lines, offering some repose to the eye, and relieving the principal features of the work, all of which must be designed with careful attention to the proportions of the object itself, and the place it is to occupy. The first principle of decorative ornament is that the spectator should have a full and distinct view of it as soon as he is sufficiently near to comprehend the whole at one glance. It must be considered a great fault if, at that distance, the ornaments which take up so much of the whole space should present to the eye an indistinct chaos of scrolls, tendrils, and foliage, and if no clear idea of the course of the lines and the distribution of the parts is to be obtained except at a very close proximity. An incorrect application of ornament of this nature may often produce an effect the very opposite to that of the model, especially in deep undercut or perforated ornaments, in which the lighter or darker colours of the intervening parts come into consideration. An especial fault of deep undercut or perforated ornaments in larger objects is their conception and execution. Their distribution is too monotonous; they are without any principal features or dominant lines. The background, though visible, is little attended to, so that they frequently produce the effect of a rough-grained surface instead of imparting to it a life and spirit of its own by beautiful and appropriate decoration. What has been said above refers

chiefly to the contour or profile, but it may be equally applied to those ornamental parts which are in relief. With many objects in cast work a flat relief is often necessary, so that with these a diaper or a repeated pattern arrangement of the ornaments will be the most suitable, regard being had to the above observations on the distribution of the spaces and the rhythmical arrangement of the main lines. A great number of objects in virtue of their destination not only allow the use of high and bold relief, but it is even absolutely necessary from their position in open and vast spaces. But in the latter case, as with the flat surfaces, the alternation of greater lines, the effective distribution of light and shade must be carefully attended to, or the delicate effect of the relief will be diminished if not destroyed.

CILING AND WALL DECORATION IN MODELLED PLASTER.—Plaster work is the natural covering of walls and ceilings. It is not governed by coursing or jointing as in stone or brick, and there is no piecing or framing as in wood. The full face of plaster presents a breadth of field such as no other building material possesses. What better surface can be obtained for architectural and decorative effects? The broad surfaces on ceilings, coves, and walls suggest and invite decoration, and no better material can be used for this purpose than a material similar to that used for forming the straight and smooth surface which covers the rough walls and the open wood work of the ceiling. Ample evidence is adduced in this work to show that plaster has been used by the greatest of architects and artists in all countries for surface decoration as well as for plain surfaces. Splendid story-telling art has been produced in the past by means of modelled plaster decoration. Mr E. S. Prior, M.A., says: "Plaster is the most impressionable of all materials which give an architectural surface. Its response to the hands of the craftsman is sympathetic and immediate. It has not to be chiselled like stone or wood, or have ideas hammered out of it like iron: a touch of the finger gives it life." Plaster is easy to manipulate, reasonable in price, and very durable; can be polished, made washable, or painted and gilt.

With regard to designing for ceiling and wall decoration in modelled plaster, the first and most important factor is proportion or scale, and the second is the suitability to the structural and architectural surroundings, and to the position, height, and forms which it is intended to enrich and beautify. Neither delicacy of modelling, fertility of imagination and resource, nor the power to bring the beautiful forms into harmonious relation to each other, will condone the least fault in the matter of proportion. The general architectural features give the scale, and the light in which the work is shown should regulate the projection or relief of the decoration.

Small details and repeated parts should be avoided; the great charm of this work is not only that it should be artistically done, but that no part should be an absolute "repeat." The plan of the decorations should be in harmony with the cornice enrichments, and in direct relation to the architectural details on the walls. In large surfaces a repeated pattern is often unavoidable, but it is obvious that they should be connected with each other in such a manner as to avoid all complicated or intricate combinations. Repeated patterns that cover a large surface are not so objectionable as small repeated parts. One cannot see the whole of a ceiling at once, yet it is possible to see a sufficiently large section to comprehend the general scheme and motive of the design. There is no royal road to the art of design. It is easy to throw out a suggestion or to recognise the wide permission of treatment granted by past examples of surface decoration, but to embody ideal results in the art is somewhat difficult. The power of design may be said to be an inborn gift, though fostered by the faculty of observation; and the art may be further cultivated by study, especially of the materials to be used, and the place and surroundings for which it is specially intended.

With reference to the modelling, the advantage of executing the work in the place instead of for the place where it is to be seen will be obvious to practical minds. Here the true effects of light and shade, and the best projection to suit the light and height, can be judged, arranged, developed, and decided. The treatment of modelled ornamentation in a frieze or a cove is somewhat different to that of a large surface such as a ceiling. The frieze must be first spaced to suit the intersections of the ceiling mouldings with the cornice. If there are columns or pilasters on the walls, the main features or mouldings on the ceiling must be planned to be in a line with the axes of the columns; this of course regulates the divisions of the frieze. If the light is cut off by reason of great space between the top of the windows and the ceiling, it is necessary to make the frieze ornament in high relief, but somewhat flat on the surface, so as to obtain definition of outline. If the work is exposed to a full light, the projection should be reduced and the relief subdued, otherwise the work will have a harsh or coarse effect. In a frieze subject to a strong side light, the vertical lines should be carefully dealt with, as the resulting shadows are much stronger than from angular lines. The treatment of the modelling of ceiling ornament should be different from that employed for modelled forms in any other situation. As previously mentioned, the matter of proportion or scale is the essence of the work, and though it presents greater difficulties, it offers infinitely greater opportunities for artistic decoration.

In dealing with the subject of designing ornamental plaster ceilings, I think it will prove both instructive and interesting, to give the opinions of an architect on this subject. These opinions are extracts from a paper read before the R.I.B.A. on "The History and Uses of Plaster-Work, especially as relating to Ornamental Ceilings," by Mr Basil Champneys, B.A. Cantab., and are as follows:—"It is not very probable that in the usual practice of an architect the more elaborate forms will be required. The figure paintings on ceilings which, under the auspices mainly of Italian painters, were much in vogue during the last century, and of which many examples remain, are scarcely likely to be revived, nor do many of us, I imagine, wish that the fashion should come back. For practical purposes we shall find ourselves left to do the best we can with the use of patterns, from which figure-work will be in the main excluded. And in the use of pattern-work, whether it be flat or in relief, we shall find that very much the same laws apply. The principal rule in either case will be, as stated above, to observe great moderation and repose. So that if the effect be produced by colour only, the colouring should be harmonious, and with but little difference in tone between the pattern and the groundwork. If relief be used, the relief should be low. But there are other considerations which must not be lost sight of. Of these the most important is that the pattern employed must not be one which leads in any one direction. On perpendicular surfaces a pattern which has an upward tendency or growth is clearly in its right place. That which has a horizontal tendency may often be legitimately and successfully employed. On a ceiling the principle is altogether different. In this case the growth or tendency must either be neutral—that is to say, it must lead nowhere in particular—or it must be either from the cornice towards the centre of the ceiling, or from the centre to the cornice. It is obvious that all such patterns as are small, and consequently have to repeat themselves, must come under the first rule and must have a neutral tendency—that is to say, each section of the pattern used must be self-centred; and there are various kinds of patterns which will fulfil this requirement. Geometrical patterns, such as squares or diamonds with central ornaments, reticulated or interlacing patterns of various kinds, and spirals, are all, so far, admissible; and it is clear that such a pattern may be of any size, so that it be less than one-fourth of the ceiling to which it is applied.

"There are, however, some further reservations which may be made as to the use of patterns

In the first place, rectangular patterns are apt to militate against another principle which I have advocated—that, namely, of repose; rectangular lines have a tendency to force themselves rather importunately on the attention, and seem therefore less fitted for use in ceilings than those which are more flowing. I should therefore advocate the use of reticulations or spirals where a repeated pattern was employed. There is at the present time a sufficient number of stamped or relieved material which fairly well fulfil the conditions I have laid down. These, however, will be applicable only to the more humble standard of decoration, and if a richer and more varied effect is sought, resort may be had either to hand decoration in colours, or to plaster relief, and we shall then be free to employ a design as large as the ceiling admits of, provided that it fulfil the condition of leading neither down nor across the room. It must, therefore, either focus towards the centre, or radiate from the centre towards the walls. On first principles either of these methods would appear to be equally admissible. I have, however, found in practice that such designs as seem to grow from the cornice rather than from the centre produce a more satisfactory effect. The reason of this is not perhaps obvious, but I think that it may be accounted for. Upward growth is the best 'motive' of decoration in walls; lines which appear to harmonise with this upward tendency, and carry it forward into the ceiling, are perhaps naturally the more appropriate. As a confirmation of this principle, I have found that an entasis or a doming of the ceiling immediately above the cornice, however slight, often tends to improve the effect. If this system is adopted, it usually adds to the effect of the ceiling if a certain amount of plain surface is left about the centre. If the other plan were adopted, that of radiating from the centre of the ceiling, I should be disposed to leave a plain or neutral space above the cornice; so that the respective tendencies of the ceiling decoration and of the wall decoration should not come into immediate collision.

"So much for the general principles which should govern the design of ceilings. As to the particular type of design which seems to give the best effects, I have already hinted my own preferences in giving a brief account of the ceilings of past times. No school of design seems to me so applicable as that of which the Slyfield ceiling is an example; there strapwork is used in connection with a subordinate pattern of swags and sprays, and combined with and enlivened by the introduction of grotesques.

"In adapting the 'motives' of this type of design it will be found that the base of the ornament, the strapwork, can best be used to give breadth and freedom to the whole, while the subordinate patterns or sprays may be so handled as to prevent the breadth from degenerating into coarseness. I have found by experience that there is no need to be afraid of the size of the main pattern. The largest curves that the space admits of may be safely laid out, and dignity gained thereby, while refinement may be insured by the interplay of the subordinate decoration."

With reference to the Slyfield ceiling, mentioned above, Mr Champney says: "In a most interesting, and, as I think, beautiful ceiling at Slyfield Manor House, in Surrey, the combination of strapwork, *amorini*, and delicate ribbon-work and swags is peculiarly interesting, and it has, as I may confess, been to me the 'motive' of many an ornamental plaster ceiling. A comparison of the ceiling of the chapel with that of a room below, which I take to have been the withdrawing-room in the original and complete house, will serve to show—for I am convinced that the pair of ceilings are of the same or nearly the same date—how great the scope of design was at this most prolific period, the earlier half of the seventeenth century; and I am disposed to think that this epoch, in the matter of plaster design, bears the palm for perfection as well as for variety. It is at this stage that the utmost boldness is found, I think, combined with refinement of design, while the most perfect comprehension is shown of the effect proper to the material."

As an independent opinion on the subject of figure-work, modelling frieze and ceiling ornamentation, and on surface treatment and texture, I cannot do better than quote Mr Stephen Webb (probably the most artistic modeller of the present day, who in a paper on "Modelling for Plaster Work," read before the R.I.B.A., gave his views with so much judgment and perspicuity that they deserve perpetuation. With regard to figure-work in frieze decoration, Mr Webb says: "When the human figure is introduced into work of this kind, it should be done with the utmost care, since, while the lack of care or skill in the arrangement or distribution or even the drawing of the ordinary decorative objects might be sometimes overlooked by anybody but an expert, the incorrect modelling of a figure, simply as a figure, or its unskilful application to the design, is always obvious and always disastrous. Use the figure, however, in such a manner as to assist rather than interfere with the design; and if this needed any corroboration, I would point to the fact that few really successful examples of its use are to be found in these days. There is seldom much to complain of in the manipulation or drawing of the figures as figures. Even the worst failures of this kind frequently give evidence of skill on the part of the craftsman in the delineation of the human form. But the impression generally conveyed to the mind of a trained artist, when he looks on one of these productions for the first time, is that the producer must have designed and modelled his ornament first, and then bought a figure at a shop, or got one somewhere, and inserted it wherever there happened providentially to be room in the composition for a figure to sit or stand or sprawl. If there be any motive at all apparent, it is that somebody has been extremely anxious to show what an intricate knowledge he possesses of the manner in which the human figure is made. Now that is a matter which, interesting and important as it may be to himself personally, has no interest or importance in this connection to anybody else, since we can, any of us, find that part of the business better done in the first fairly good group of statuary which we meet with. Assuming the necessary knowledge of the drawing of the figure on the part of the artist in this work, what we want of him is, that he show us how it may be used in some fresh and artistic combination with other forms, so that a man of cultivated taste may receive pleasure in looking at the composition as a whole; and also, that we of the craft may not only receive pleasure, but haply some guidance to our own efforts in the same direction."

In connection with the treatment of modelling for ceiling decoration, Mr Webb says: "Raising and playing with the edges of forms, of which such effective use can be made in the modelling of the frieze, is hardly ever admissible for ceilings. In fact, nearly all the ordinary means in use by modellers, by which effect is got, are rather worse than useless here; and though I think I am able to see why you should model things on ceilings, since, properly, nothing else gives such an effect of completeness to the decoration of a room, . . . I feel that modelling on ceilings should never be in the smallest degree assertive. . . . In no other relief work with which I am familiar is the necessity for self-repression in the artist so constant, or any indulgence in striving for cheap effect so severely punished, as in this. My own plan is to select what I consider the most graceful and manageable forms in the style in which the work is to be done, treating all the minor and subservient shapes and connections very flatly, and the larger forms with extreme care, so that there shall be no abrupt shadows cast from them—thinking, in fact, most about the management of the light and the preservation of a breadth of effect, and getting no more shade anywhere than is absolutely necessary to define the forms and give expression to the idea. It is, of course, well to vary the central and leading objects as far as is practicable, since too much repetition is fatiguing over large surfaces."

With regard to surface treatment and texture, Mr Webb very pertinently says: "If a piece of

ornament has been clearly conceived, firmly laid in, and dexterously brought forward to the point at which the last detail may be introduced, it should have a surface then which is far more interesting to an artist than any other. But work done in that way assumes the possession, on the part of the modeller, of a power and mastery of means which are not possessed by all makers of ceiling decoration; and as any hesitation—any feebleness or clumsiness—must appear in work thus left, the usual, indeed the only, thing to do then, is to smooth it all over by a laborious and sometimes costly after-process. I have heard architects and others lament the loss of effect in a piece of work through this process of smoothing, but I do not think there is ever much real harm done, since the very fact of having resorted to it may generally be taken as a pretty sure indication that there was never anything in the surface worth preserving. It is, however, very grievous when, as sometimes happens, in deference perhaps to the prejudices of somebody who should have known better, a really artistic piece of work has to be handed over to the clay smoother or plaster carver and its interest destroyed."

METHOD OF MODELLING IN SITU.—The method for modelling *in situ* and also modelling direct on slabs or plaques which are to be fixed on ceilings or walls is similar to modelling in clay. It is advisable to make a rough sketch to scale on paper, not to make a finished sketch, to leave the details of balance, light, and shade to be effected in the actual work and in position, where these points can be best judged and any defects corrected. The principal lines and parts should be set out on the plastered surface as working lines to regulate the main proportions, to act as guides for right and left or reversed parts of the pattern, and to balance the whole. This is effected by setting out lines so as to divide the surface into squares, or diagonals, or both, according to the nature of the design. The size and positions of these divisions are taken from the paper sketch. For important and massive parts or works a small sketch model in plaster is advantageous. The lines can be struck with a chalk line, or made with a chalk or lead pencil and the aid of a straight-edge. Circular lines can be formed with a compass, using the centres or intersection of the square or diagonal divisions as centres. The small lines and curves of the design are drawn by hand. Nicety or finish is not here required, as the lines are used more for keying the surface than as a guide for the modelling. The surface should be cut to form a key for thick or deep parts in the design, and roughed to give a key for thinner or lighter parts. All plasters and cements have more or less adhesive powers, but keying is necessary not only to ensure the requisite strength to support deep or heavy parts of the enrichment, but also to resist the effects of vibration which is found in nearly all buildings, especially on ceilings. Heavy or deep parts may be further strengthened by means of nails or screws, which should be inserted into the wood work on ceilings, or joints in brick or stone walls. A few flat-headed nails or clouts driven into the plaster will be sufficient for most purposes. Extra heavy or deep parts can be supported by means of wrought-iron nails and tar rope, constructed as described for "spike and rope brackets."

Having set out the divisional lines and serrated the surface, dust and damp the serrations and surface, then proceed with the modelling. For large surfaces only take in hand a space that can be conveniently reached at a time without much moving, so that a right and left part of enrichment can be worked in unison. Block out deep and heavy parts first, taking two or more, according to the size on hand, so that they can be worked up by degrees or as the stuff sets. These deep parts can be finished when modelling the adjoining thin parts. Small or thin ornament, such as foliage, stems, flat leaves, are best finished in one operation, or as the work proceeds. When it is inconvenient to finish the part in hand in one operation, it should be finished before it is quite dry, as it is difficult to lay the following coat on a dry surface. The stuff will not work freely or adhere to

a dry surface. Of course the surface may be wetted or damped with water, but this is often objectionable, as falling water may spoil other work already finished; too much water on the surface also destroys the consistency of the finishing stuff, prevents cohesion, and weakens the finished surface. When blocking out deep parts that cannot be finished in one day, or if the stuff sets before the next coat is applied, these unfinished parts should be roughed to give a key for the following coat. The joints of a finished part should always be roughed to give a key for the following parts. These items tend to prove that for general purposes no more work should be commenced or taken in hand than can be finished in one day, and that the parts should be finished as the work proceeds.

MATERIALS FOR MODELLED PLASTER WORK.—It is important that the materials used for the plastered surface or background on which the ornament is to be modelled, should be of the best quality, and adapted for their position. A material suitable for interiors may not be equally suitable for exteriors. For the foundation double lath or lath and half should be used. Oak laths are strong and very durable for this purpose, but metal lathing, which is practically fireproof, is doubtless the best material for this purpose. It is false economy to build or execute artistic and valuable work on a weak and unreliable foundation. For interior work, the groundwork may be formed with well-seasoned and prepared lime and hair gauged with plaster, or with Parian or other white cement. If the work is exposed to atmospheric influences, such as open corridors and vestibules, the lime mortar should be gauged with Portland cement or other hydraulic cement. For exterior work the groundwork may be composed of Portland cement or hydraulic lime. The proportions and method of using these materials are described in Chapter V. If a matted or rough surface or background is desired, the plastered surface should not be set or fined, but the floating coat should be left with a rough surface to give a key for the proposed matted surface. The matted background should be formed with the modelling. Modelled work may also be executed direct on brick, stone, or concrete walls, without a plastered surface. The wall surface must be hacked with a chisel or an axe to give a key for the modelled work. The intermediate spaces between the ornamentation may be left in their natural state or brushed over with liquid cement or plaster, or a matted background may be formed as the modelling proceeds.

With regard to the materials to be used for direct modelling or modelled work, they may be composed of most plastic material in use for plaster work as shown in the description of old stuccos, Chapter IV. Plaster gauged with size water to retard the setting is a good and easily worked material. The setting can be regulated for from five minutes to as many hours. The subsequent hardness can be improved by the addition of a small quantity of lime putty. Parian cement is an excellent material for modelled ornamentation. Its slow-setting powers and ultimate hardness cause it to be of essential service for modelled decorations. The addition of a small quantity of silver sand or well-washed and finely-sifted sand gives the cement more grip and freedom in working. The initial "set" of Parian cement often takes place nearly as soon as gauged, but it has the property of resetting after being softened by adding water and reworking as already mentioned. The setting may be retarded by air-slaking the cement from twelve to twenty-four hours. Care must be taken when exposing the cement that it is put in a dry place. Damp will make it lumpy, and otherwise spoil it for this purpose. For interior work, a little marble dust added to any of the above-mentioned materials will render them bright, hard, and washable. The plaster work made of "rye dough" mentioned by Le Neve may also be employed for modelled decorations. The rye meal was probably used to retard the too rapid setting of large surfaces, thus enabling the modelling to be longer continued. Mr G. T. Robinson, who has tried it, says "it makes an excellent com-

pound for modelling in," and that "it retains its pliancy long, dries hard, and is of a beautiful old-ivory tone." Portland cement, selenitic, or hydraulic lime, owing to their resistance to atmospheric influences, are the best materials for exterior decorations. The setting of Portland cement can be accelerated by adding a small quantity of fresh Sheppey or Medina cement. Either of these cements may be used without fear of deteriorating the necessary hardness of the Portland cement for this purpose. Portland cement is rendered more pliable by the addition of a small quantity of old lime putty, and the addition of a little sand renders the manipulation freer. For deep parts of modelled decorations the addition of a small quantity of hair or fibre gives tenacity to the material used for blocking out. This also gives greater freedom in working, holds the material in position until set, and prevents it dropping while the work is in progress. These materials can be coloured as desired by using the ingredients mentioned for stuccos, scagliola, and concrete.

MODELLING IN CEMENT.—Figures of the human and animal forms are frequently made in Portland cement or fine concrete for exterior decoration, and in white cement or plaster for interior decoration. The usual way is to model them in clay and then mould and cast them, but it is more economical, besides offering greater variety in conception and manipulation, to model the work direct in the final material.

For figures of the human form, the modeller, like every other creative artist, begins by making a sketch model of the proposed figure, which serves to fix and regulate his conception while working at the real figure, and enables him to alter it at pleasure, while otherwise this would be difficult. The model, though on a small scale, must bear a resemblance in form, position, features, and drapery to the future full-sized figure, and it must be so well done that it will serve as a guide throughout. For a figure life-size, or for a figure with outstretched arms, it is necessary to provide an iron frame sufficiently strong to bear the weight of the cement until set, and also act as an internal support for thin or projecting parts in the figure. From careful calculations of the sketch, the iron frame is prepared in such a way that iron rods and, where possible, strong lead pipes or gas-pipes, whose flexibility facilitates later alterations, give the body as well as the extremities a secure inner support. For large figures, an outer but lighter frame, composed of hoop iron bands or with wire netting, is fixed on the main iron frame so as to form a core in the thickest parts of the figure. This iron skeleton is then clothed with cement and modelled.

The same process used for modelling a figure in clay should be used when modelling direct in cement, therefore the naked figure is modelled first, for although it is to be clothed, the greatest possible care should be bestowed upon the body. However voluminous the folds in a figure may be, there are always certain places where the body is visible, therefore every limb must be natural and anatomically correct. The less drapery the finer must be the work bestowed upon the naked figure, that it may form a harmonious and beautiful whole.

The method of constructing the iron work, coring out materials, and using same for figure work in cement or fine concrete, is further elucidated in Chapter XIX.

WAX MODELLING.—The modelling of medallions for portraiture is considered more difficult than modelling on the "round," *z. e.*, an object free of background, as a statue or an apple. The main object is to produce the effect of roundness with the lowest possible relief, contour being obtained by fine gradations and delicate touches. Medallions may be modelled in wax at home, as it does not require much space, and is not dirty work. Thus the studious apprentice can pass a part of his leisure time in a pleasant and profitable way. Modelling in wax has the advantage over clay that the work can be commenced, set aside for an indefinite time, and then resumed without

injury. The wax is made pliant by slightly warming and working by hand. Employ it in the same way as clay. Steel, brass, bone, and wood tools are used for modelling wax. They work freely if rubbed with oily rags. Medallions are best modelled on a sheet of plate glass, as it can be reversed, and faults in outline can thus be easily detected.

MODELLING WAX.—There are various ways of preparing this material. The following are the best known. Dissolve in a pipkin over a slow fire a quantity of pure yellow beeswax, then add a twelfth part of powdered resin, and a tenth part of Venice turpentine, and stir well, taking care that it does not boil. Add flake white until of the desired consistency. Test the plasticity of the wax by taking out a small portion on the end of the stirring stick, and after it is cool, work it in the hands until plastic. If it is too sticky, add more pure wax, as there is excess of turpentine. When worked and kneaded, it should draw out into long strings before breaking. Another kind is made in the same way, using the following materials:—50 parts virgin wax, 4 parts Venice turpentine, and 2 parts pure lard, adding fine sifted whiting *ad lib.* Another kind, generally used by sculptors, is made by dissolving 1¼ lbs. of beeswax, ½ lb. of lard, and ½ gill of linseed oil, then add 1 lb. of flour. If too sticky, add more flour, and knead all together. Another kind, commonly used in London, is composed of 10 parts of beeswax, 12 parts of lard, and 3 parts of olive oil, all by weight. Dissolve these ingredients together, and when cold, add fine sifted whiting until of the desired consistency, and knead together. Paraffin wax is sometimes used as a basis, and some kinds of squeezing wax are also used for modelling purposes. Other wax recipes are given in the Appendix.

BEEWAX.—This is a thick, viscid, tenacious substance, excreted by bees, and used by them in the construction of the combs. There are several artificial waxes made from fats, resins, &c. Chinese wax is derived from an insect, the *Coccus ceriferus*. Japan wax is of a vegetable nature. Carnauba wax is also derived from a plant found in Brazil. Myrica, or wax myrtle, is obtained from a North American shrub. Mineral wax is a bituminous substance found in the Carpathian Mountains near Starick. Beeswax, when pure, is the best for all moulding or modelling purposes. It is sometimes adulterated with artificial wax. English or American beeswax is the best for all plastic purposes.

MODELLING IN TOW.—Modelling large work for temporary decorations is done in tow and plaster, gauged with size water. This saves moulding and casting, and the work is strong, light, and dries quickly, and if painted, will stand exposure to the weather for a long time. There are various ways of modelling in tow. One plan is to steep common hay-bands in plaster, gauged with size water, lay them on rough framework, gradually building up until the outline is obtained. The work is then finished with chopped tow and gauged plaster. Another way is to dip sheets of canvas or tow in gauged plaster, and lay them upon a foundation of loose tow, hay, or straw, which being soft and compressible, the rough form can be easily obtained, while the canvas and plaster remains plastic. When it is set, the modelling is finished with fine chopped tow and gauged plaster. If it is wanted extra smooth, the model is finished when in a green or moist state with fine plaster, gauged with size water. Bold effects in draperies are obtained by dipping long strips of canvas into gauged plaster, and arranging it into folds, while the plaster is soft or unset. This class of work is often employed in Italy, Austria, and Germany, and has been used in this country for the decorations of triumphal arches, &c. I have used it for large capitals and figures in theatrical properties with good results. A heroic statue of Schiller, by Professor Shilling, of Dresden, was constructed in this manner during the celebration of his centenary in the Alt Markt, and afterwards removed to a garden, where it stood for years.

ARCHITECTURAL MODEL MAKING.—Architectural model making is the formation of small

models made to scale of buildings, land, &c. They are used to supplement the drawings of buildings, &c. Models afford a clear and correct guide and reference in law cases, and enable non-practical men, or those who cannot interpret plans, sections, and elevations on paper, to see and understand the various parts and positions of buildings, &c. Architectural models are useful to enable architects and designers to judge the effect of their works on the round. Models afford a ready solution as to the requirements of clients. When definitely designed, a model may avoid extras and subsequent recriminations. Models made in plaster of some of the principal ancient and modern buildings from various parts of the world are to be seen in many museums.

Various materials are used in the construction of architectural models. Cardboard or thin slabs of fibrous plaster are generally used for large plain surfaces. Corrugated paper is useful for many parts of cardboard models. Paper models are fixed with wax, glue, wire, &c. Water-colour is used for getting any desired tint. Liquid wax is sometimes spread over cardboard surfaces on which sizes and forms of stones, &c., can be shown by indentations and modelling. French putty is sometimes used for sketch models. It can be coloured with powders, and when spread over cardboard, readily takes any form of surface. It is, however, too soft for permanent work, and is only used for trial work, or for temporary purposes. Modelling wax, also paraffin wax and Venice turpentine, dissolved together, are excellent materials for surfaces. Powdered colour will give any tint, and any desired texture is obtained by the mixture of suitable materials, such as silver sand, bird sand, marble dust, granite dust, sawdust, cork dust, &c. Ground rice gives a fine granulated surface, and French chalk a soft silky one. Wax gives the best results, as it takes and retains both colour and texture with permanence. Fibrous plaster slabs for the construction of architectural models may be cast to the desired sizes, or large slabs cut up to fit the various parts of the model. Mouldings may be "run down," and then fixed as required. A better way is to cast them with the slabs in one piece. Ornamental parts may be cast in a similar way, or they can be worked on the model in modelling wax, gesso, or plaster. Small models may be entirely constructed of modelling wax. A plaster core is fixed on a modelling board to reduce the quantity of wax, and steady it while being modelled. Architectural models may also be entirely composed of fibrous plaster. The model is first made in plaster or modelled in clay, and then jelly moulded, and a fibrous plaster cast obtained. This is a good and economical method where a strong or permanent model is desirable. The cast being in one piece, without joints, it combines lightness with strength. It can also be made in sections to show the interior. The model can be coloured as required. If necessary, it may be further hardened to resist damp and wear by the same process as described for fibrous plaster.

CHAPTER IX.

MOULDING AND CASTING.

PLASTERER'S SHOP—PATENT PLASTER BOX—FRONTISPIECE—SQUEEZING WAX—CASTING WAX—MOULDING WAX—WAX MOULDING—SKIN WAX MOULDING—WASTE WAX MOULDING—MAKING FRONT AND OPEN FRONT WAX MOULDS—MAKING JOINTED, SURFACE, AND FRONT AND BACK WAX MOULDS—MAKING MOULDING PIECES FROM FRONT AND BACK MOULDS—WAX PIECE MOULDING—MOULDING PLAQUES—CHASING WAX MOULDS—CLAY SQUEEZING—CLAY PIECE MOULDS—PLASTER WASTE MOULDING—MOULDING FROM LIFE—PLASTER PIECE MOULDING—MODILLIONS—MODEL MAKING OF BALUSTERS—PLASTER PIECE MOULDING BALUSTERS—DUPLICATING PILCE MOULDS—CASTING BALUSTERS—PLASTER PIECE MOULDING VASES—CASTING VASES—OILING PLASTER MOULDS—SOLUTIONS FOR MOULDING AND CASTING—OILING WAX MOULDS—BALL OIL POT—GAUGING PLASTER—USES FOR OLD PLASTER—PLASTER CASTING—HOLLOW CASTS—FURRED MOULDS—STRONG PLASTER FOR CASTING—CASTING WHITE CEMENTS—CASTING PORTLAND CEMENT—WATER SEASONED PLASTER MOULDS—CASTING CEMENT MOULDINGS—WASTE MOULD PROCESS—PRESSED CEMENT WORK—METHOD OF REDUCING OR ENLARGING IRREGULAR FIGURES.

PLASTERER'S SHOP.—A plasterer's shop should be dry and well lighted, and contain a fireplace or stove for heating water and dissolving wax or jelly. Good and sufficient benches are indispensable. The tops may be composed of wood or Portland cement. A wood grating about 20 inches wide, placed in front of the casting benches, raises the boys and keeps the men's feet dry and clean. There should be a large shallow tub for hot water, or better still, a large concrete tank. A square bench, placed so that a man can get all round it, will be found useful for moulding and casting large centre flowers or panels. There must be shelves for stacking moulds and cast work. Clean water tank, and size water tub, and a slush tub are necessary. The slush tub should be placed under the gauging spot, so that it will be convenient for washing gauge pots in, and any excess water will run into it. A sufficient number of earthenware, guttapercha, or copper gauge pots, and a water measure, will soon repay the cost. Other requisites are a few slate slabs for making plaster grounds on, and also for modelling and moulding; a quantity of running rules, thickness rules, and feather-edges; a mitre box, square, compasses, jack-plane, chisel, saw, vice, shears, and files. Strips of lead or zinc, about 6 inches wide, are useful for fences when moulding large circular work or making cases. They can be used with more speed than clay, and will serve repeatedly. Pails, oil, shellac, soap, wax, and jelly pots are requisites. Fish skin is an excellent article for rubbing down plaster or cement surfaces; it is not affected by water. Dutch rush (*equisetum*) is useful for cleaning off seams and polishing plaster. Cement and plaster boxes are important. A good yard attached to the shop is necessary. The yard should contain tanks for water and cement work; bins for putty, setting stuff, coarse stuff, sand, crushed granite, and other aggregates; storage for scaffolding and general plant; an enclosed shed for cement, sacks, scales, canvas, plaster, and fibrous laths are all useful. Where specialties are made, more plant is required in the plasterer's yard and shop. A considerable amount of room is required for concrete work and artificial stone. The following is a good plaster box.

PATENT PLASTER BOX.—Illustration No. 88 shows a novel form of a self-feeding plaster box

which I have introduced. It keeps the plaster dry and clean, and it is easily got at when gauging. It is made to hold 4 bushels of fine plaster and 4 bushels of coarse. The inside size is 3 feet by 3 feet by 1 foot 3 inches. Open trough in front (sloping) about 8 inches deep and 6 inches projection. The front of the box does not extend to the bottom, so as to allow the plaster to run into the trough. A division in the box and trough keeps the fine plaster separate from the coarse. The top slides in two pieces, and keeps the plaster clean. A shelf is formed underneath, on which the working utensils are placed when not in use. G is a "gauge spot," on which the gauge pot stands while required. This is fixed with a fall outwards, to allow any spilt water to run into the slush tub S. Another gauge spot can be fixed at the other end of the plaster box. An independent gauge spot placed in front of the box, so that two or more men can gauge at the same time, is often useful. In this case the slush tub is placed in front of the gauge spot, and a water tub and size water tub should be

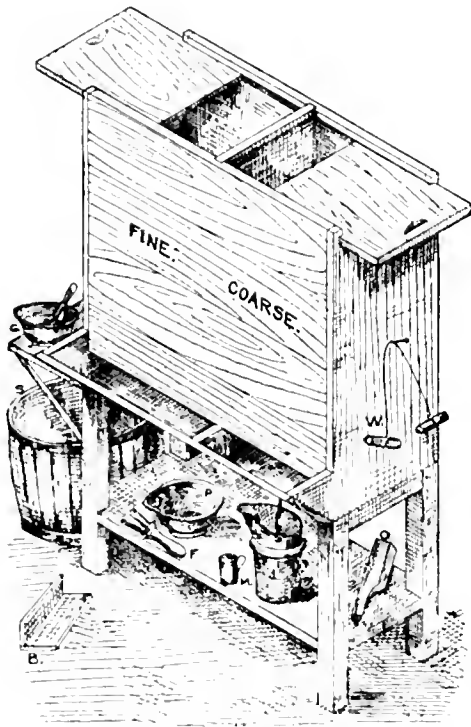

NO. 88. — PATENT PLASTER BOX.

placed at the ends. W is a wire clay cutter. This is formed with a copper or brass wire about 20 inches long, and fastened to two wooden handles. It is used for cutting tempered clay blocks into sections, also for cutting and jointing plaster grounds. C is a clay-beater. This is composed of hardwood, and is 18 inches long. It is used for beating out sheets of clay which have first been tempered by beating with an iron bar or pipe. J is a jelly pot; M is a water pot for measuring the water for gauging; F is a fibrous plaster brush; P is a gauge pot; and B is a moulding box.

FRONTISPIECE.—A combined modelling and moulding shop is shown on the frontispiece. This elaborate and allegorical design is the official emblem of the National Association of Operative Plasterers. On the plinth at the base is the plasterers' coat-of-arms. On the shield is a stock-brush, a laying and a gauging trowel. On the bar is the word "Friendship." On the top is a helmet and mailed arm, with a hand holding a plasterer's hammer. The shield is supported by two griffins, and on the ribbon scroll is the motto, "Let brotherly love continue." The escutcheon is surrounded by laurel leaves. The dies of the pedestals are enriched with sunk ovals and raised foliated wreaths of flowers. In one

of the ovals are the gauging trowel, hand-float, and plumb-bob, and in another are the square and compass. The figure on the pedestal at the left hand side represents Architecture, with a globe at the side. The figure on the right hand is Art, with a bust at the side. The lower half of the frame is the modeller's studio. The youth on the left is casting; the two men sitting at the bench in the middle are cleaning up, trimming and jointing ornaments. Each man has a moulding box in front of him to fit and square the work on. The apprentice at the bench in front is waste moulding. At the easel a modeller is at work on a medallion. On the left side is a statue of the Venus de Milo, and on the right is a draped figure. At the back on a pedestal is a large bust, and on another pedestal is a figure of Cupid. On the walls and benches are casts of an arm, angle pieces, bed moulds, columns, caps, centre flowers, diapers, friezes, frets, guilloches, lions' heads,

medallions, panels, soffits, vase, and portions of enriched cornices. The top half of frame is a room with the plasterers busy at work on the walls, after having finished the richly coffered ceiling and enriched cornice. The plasterer at the left is laying on gauged cement for mitring the window architraves, the one in the middle is fixing ornaments in the door architrave, and the one on the right is setting the panels. A bust of Minerva forms the cap or top finish to the keystone of the arch. Above this is the motto, "United we stand, divided we fall." In the tympanum of the pediment are two stalks of myrtle, tied with a love-knot, and encircled with a wreath of olive leaves, typical of friendship and peace. The upper entablature is adorned with swags and festoons of flowers and ribbons, and in the centre is the title of the Association. At each side are two Cupids supporting shields, with mottoes. On the top are two vases with flowers, and two Cupids holding cornucopias or horns of plenty. The apex or centre figure represents Unity, crowned with a laurel wreath, and in her hands a bound bundle of reeds. The bound bundle of reeds signifies that a single reed may be bent or broken; but a united bundle, bound with the bands of harmony and justice, cannot be bent or broken. Another meaning is that a united bundle of reeds will stand on end, whereas if divided the single reeds would fall; this being also the origin of the motto, "United we stand, divided we fall." The mottoes and sentiments on the emblem are good alike for employers and employees. Their interests should be identical, and in the event of any unhappy differences or disputes, they should refer to the happy medium of just arbitration and conciliation, and not resort to the unwise and unsatisfactory issue of lock-outs and strikes.

SQUEEZING WAX.—Squeezing wax is used for taking an impression of metal, wood, stone, or plaster models for reference purposes. The surface of the model should be dusted with French chalk to prevent adhesion and discoloration of the model. Where there are several pieces required for one model, the joints should be dusted, and the whole cased with plaster to keep them in position. The squeeze is then filled in with plaster, thus producing a replica of the model. There is a variety of ways for making this material. The following are respectively English, French, Belgian, and Austrian recipes:—1. Take $\frac{1}{2}$ lb. of pure beeswax, $\frac{1}{2}$ lb. of lard, and 1 gill of linseed oil; melt over a slow fire, then sprinkle in 1 lb. of flour, and stir well, then pour the whole out on a slate or bench and knead all together. If the wax is too sticky, add a little flour, and knead until of the desired consistency. 2. Take 1 lb. of beeswax, $1\frac{1}{2}$ lbs. of lard, and 1 gill of olive oil; dissolve over a slow fire, and add sifted whiting until of the desired consistency, and knead as before. 3. Take $\frac{3}{4}$ lb. of beeswax, $\frac{1}{4}$ lb. of Burgundy pitch, and dissolve over a slow fire, and add $\frac{3}{4}$ pint of olive oil; gradually stir in equal parts of flour and fine sifted whiting until of the desired consistency, then turn it out on a slab, and knead it until it is of a pliant nature, adding whiting as required. The more it is worked, the better it will be. 4. Take 2 parts of beeswax, 1 part suet, and 1 part turpentine; dissolve, and add fine whiting as before. If coloured wax is desired, add yellow ochre, Paris white, green, or vermilion, according to taste. Paraffin wax mixed with olive oil and whiting, prepared as above, is also used for squeezing wax.

CASTING WAX.—Wax combined with other materials is used for casting silver or bronze models, also for piece moulding. The Italian artists use a casting wax made simply of beeswax, Venice turpentine, and finely sifted wood ashes. After the wax and turpentine is melted (as in making modelling wax), a large proportion of ashes is stirred in until the mass is stiff. It is then kneaded over a charcoal brazier until it is quite plastic. This wax is used in making part of a piece mould on marble when it is difficult to get at, or where the swelling of plaster would be disastrous in a fragile figure. The surface of the wax is dusted with French chalk before taking the impress. Wax joints are also dusted when piece moulding. Girardon, the celebrated sculptor, when

casting the statue of Louis XIV., used a wax composed of 10 parts of pure yellow beeswax, 1 part turpentine, 1 part lard, and 1 part Burgundy pitch, all by weight. Bouchardon used for the equestrian statue of Louis XV. a wax consisting of 2 lbs. of pure yellow wax, 1 oz. of tallow, and $\frac{1}{4}$ oz. of resin.

MOULDING WAX.—Moulding wax is used for making moulds for plaster casting. It consists of 1 part pure beeswax, and from 1 to 2 parts of powdered resin, dissolved in a metal pot, over a slow fire, or on a hot plate. The wax should not boil, as boiling destroys the virtue of the wax, and renders the mass hard and brittle. The quantity of resin varies according to quality of the wax. A rich wax will carry more resin than a poor one. Poor wax is improved by adding from 1 to 3 oz. of mutton suet, or best white tallow, to each pound of wax. Old wax that has been frequently used becomes short, and often also full of small pieces of plaster, clay, wood, &c. It can be cleaned by thinning, with extra heat, and then pouring it through a hot sieve into another pot. Old and short wax is corrected by adding a portion of new wax and tallow, also by mixing a new batch of wax and resin with the old. When a hot plate is used, the pots should be broad and shallow, so that the heat can get to a larger surface. An average size is 14 inches diameter and 6 inches deep. They are generally made of block tin or copper, and should have a wide lip, so that the wax may run freely. There should be handles at each side. For ordinary small work, a common saucepan with a lip is suitable. Where steam is generated, the waste steam can be utilised for melting wax and jelly. In this case the pots are made deep, and placed in an iron jacket or fixed iron tank. Wax may also be dissolved by means of hot water in the same way as used for jelly. Wax or jelly melted by steam or hot water is more uniform in heat, and lasts longer. To know when wax is cool enough to pour on a plaster original, oil or wet the finger, and dip it into the wax. If it can be borne comfortably, the wax is in good condition for moulding. Never allow the wax to get too cool, or a skin will form on the surface, or it will become crinkly and unfit for moulding.

WAX MOULDING.—When about to take a mould in wax, the original must be dusted and placed in clean water to stop absorption. It should not be kept in the water too long, as excessive soaking spoils a good original. It ought to be taken out three or four minutes after the air bubbles have ceased to rise. After soaking, place the original on edge to allow the surplus water to run off, then remove the surface moisture with a sponge. This is better than a brush, as it is quicker, cleaner, and not so liable to injure the face of the original, and make it rough.

After sponging the surface, place the original on a moulding board in such a position that it will take the least possible quantity of wax to cover the highest points. Then beat out a sheet of clay about $\frac{3}{4}$ inch thick, and smooth the face with water and a gauging trowel. Afterwards cut it into strips of the required widths to form "fences" (sometimes called bandages), and fix them on edge round the original, where required, to keep the liquid wax from running out. If there are any butt or angle joints in the clay fences, they can be fixed by pushing small nails into the clay. The use of sweet oil for smoothing clay, or preventing it sticking to wax, is a serious mistake, because it spoils the clay. Water is all that is required. For the same reason, clay water, in place of oil, should be used for the joints of wax piece moulds. It is also cheaper, cleaner, and works more freely. When moulding originals, such as soffits, friezes, or other enrichments having straight sides or ends, no clay should be used as straight fences. Clay is well adapted for forming circular fences, also for short end fences. Plaster fences are quicker, and give a truer line to the outside of the mould. They are easily kept in position by pressing small pieces of clay on the moulding board close up to the plaster fence. When moulding bed moulds, such as eggs, &c., place the original in a moulding box, fix a plaster fence at the front, and clay fences for the ends. The moulding box

enables the original to be canted over, so that less wax is required. When the original is placed, and the fences secure, brush the face of the original lightly with clean water to remove any dirt and prove that suction is stopped, or until the face of the original becomes glossy or shines, then pour on the wax. This should be done on the lowest part of the ground of the original, thus causing the wax to run upwards, and forcing the air up, and helping to obviate blubs in the mould. When the wax begins to run over the face of the original, follow up with more warm wax, as the wax soon cools in running over a damp surface, and is liable to become crinkly.

SKIN WAX MOULDS.—Wax moulds having deep parts, and containing a thick body of wax, are difficult to ease when casting. In order to avoid this, and obtain a nearly uniform thickness, the moulds are “bled”—that is, the wax at the thick parts is allowed to run out, leaving a wax skin varying in thickness from $\frac{1}{4}$ inch to $\frac{1}{2}$ inch on the surface, and about $\frac{1}{2}$ inch at the sides. This enables the mould to be warmed and eased more freely, and with less liability to breakage.

A wax mould is “bled” by cutting with an oiled knife the skin of the wax at the deep parts. When the wax has been poured on, a skin is formed owing to the cooling, but the deep parts take longer to firm. This gives a guide for cutting the skin. After this is cut, turn the mould over to allow the liquid wax to run out, taking care that the hard parts of the skin are first oiled or brushed over with clay water to prevent the liquid wax from adhering to the other parts of the mould.

Large moulds having deep sections, such as a centre flower, may have 3 or 4 inches thick of wax at the outer rim. This kind of mould is cumbersome, and takes up a large portion of wax that may be wanted for other purposes. To save this, the mould is “bled,” but not in the same way as just described, because the mould being large, it is difficult to turn over. This is overcome by cutting openings at the outer rim, and forming clay channels for the liquid wax to run out into the wax pots. If warm and soft, the excess wax may be moved with a piece of stiff clay; and if cool and firm, it can be moved and smoothed by the fingers, which are previously greased to prevent sticking. After the excess wax is run off and smoothed, the surface is brushed over with thick clay water, and a plaster case made to keep the wax in position. If the case is too large to be conveniently floated over with a wet gauge board, fix a straight-edge at each side of the mould. Bone them to see that they are both level. These will serve as screeds or bearings for a floating rule when forming the dots on the back of the case. This forms a level back surface, and allows the mould to stand level and steady on the bench.

WASTE WAX MOULDING.—Waste moulds are used to save the expense of piece moulding clay models, where one cast only is required for making a moulding piece, or for cleaning up the cast before being permanently moulded. Plaster is used for waste moulding models on the round and similar works. Wax is used for small, flat, and delicate work. If the model is undercut, the wax will leave the cast sound if properly made. The clay model, if ordinarily soft, does not require any preparation to prevent the wax from adhering. If the clay is firm or semi-dry, it should be gently sprinkled with water, and the excess water blown off, or it may be carefully brushed with a soft camel-hair brush dipped in water. Care should be taken that the artistic touches of the modeller are not spoiled, or the model otherwise disturbed. In no instance should oil be used. When the clay or plaster fences have been fixed so as to prevent the wax escaping, and to form a ground if an original is required, pour the wax on the ground part until the model is all covered. When the wax is cool, but not stiff, turn the mould over and pour the surplus wax off; or if large, cut the fences at the side to allow the wax to run freely out until there is only a very thin skin of wax on the model. After this is firm, brush it all over with clay water, taking care that any undercut parts are stopped with clay, so that the plaster case will draw. The case

is now made, the mould turned up, the clay carefully taken out, and the mould well washed out with soap water. It is dried and oiled, and washed with soap water to clear off the excess oil, so as to obtain a white and sharp cast. The mould is then filled in, and when the plaster is set, prize the case off, and place the mould into hot water until the wax is soft. The skin of wax can then be drawn or peeled off without injury to the cast.

TO MAKE A FRONT WAX MOULD.—Having committed the foregoing notes on wax moulding to memory, the art of wax moulding will be readily achieved. A front mould in wax is used for moulding soffits, pateras, small bed moulds, or any other enrichment that would draw in one piece. The original model of some of these enrichments are square on the sides, or ends, or both, therefore it is necessary to splay the square parts to allow the mould to draw in one piece. The splayed parts are, of course, reproduced in the casts, and must be trimmed square with a knife so that they will joint and fit their beds. In some instances, such as small bed moulds or top leaves, the splayed parts on their outer sides require to be trimmed a little beyond the square, so as to give more relief

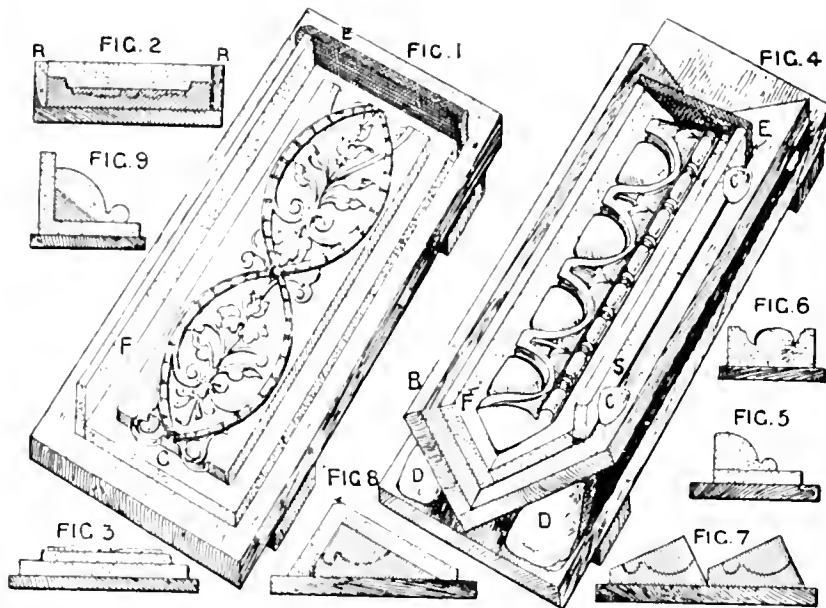

No. 89.—FIG. 1—MAKING A FRONT WAX MOULD.

FIG. 4—MAKING AN OPEN FRONT WAX MOULD.

to the work. A small soffit "in the clay" is selected for an example of making a front mould, so as to exemplify making a mould from a clay model and also a moulding piece of same. To mould the model of the soffit, first make a plaster ground about $\frac{3}{4}$ inch thick, and in length about 2 inches longer and 2 inches wider than the model. This allows 1 inch on both sides and ends for a ground, and consequently a rim 1 inch wide on the sides and ends of the mould. The side rims of a mould should for this class of work not be less than 1 inch, so as to allow a fair bearing for the fingers to ease the mould when casting. Having made the ground, lay it on a moulding board, then lay the model on the ground G, as shown at Fig. 1 on the subjoined illustration No. 89. It will be understood that the design of the soffit is modelled on a plaster ground, and that it is jointed. The thickness of this ground may vary from $\frac{1}{2}$ inch to $\frac{3}{4}$ inch, according to the length and width of the

model. As this is only intended for the purpose of making a "waste" mould, to obtain a "solid" moulding piece, the model need not be fixed permanently by scratching and bedding with plaster, but simply splaying the sides and ends with soft gauged plaster will be sufficient to hold it in position until it is moulded. Having splayed the sides and ends just as much as will allow the mould to draw, fix a plaster fence, F, against the ground, and then a clay fence, E, on the end. Repeat this on the other side and end. Plaster fences being straight and stiff should always be used for the sides of wax moulds, as they form the sides of the moulds straighter than if made with clay fences. When casting, two or more moulds are laid on a bench side by side, straight sides fit close, and prevent the waste of plaster which would occur if the sides were irregular. Clay fences for the ends are best, because they readily take the curves which are often found in the ends of some models which are necessitated by the design. Clay fences are also useful for supporting the side fences, as they can be turned round the ends of the plaster fences, as shown in the present example. One or two clay dots fixed against the sides are also required to keep the side fences in position. Having fixed the fences, carefully brush the plaster grounds and fences with water, and pour on the wax as previously described. If the model is deep or undercut the mould must be "bled" to allow the mould to leave the moulding piece more freely, as already mentioned. Now take off the mould, wash it out and lay it on a moulding board, and it is ready for taking a moulding piece.

The method of making a solid moulding piece is elucidated by Fig. 2 on illustration No. 89. This shows a section of the mould and the moulding piece (the latter is indicated by the dotted surface). To make the moulding piece fix two wooden rules, R, R, at each side, so as to form straight sides and give the desired thickness for the moulding piece. The mould is now taken off, thus leaving a solid moulding piece. It is then cleaned up, when it is ready for taking any reasonable number of moulds from. This, of course, is done precisely the same way as described for moulding the model. A section of the moulding piece is shown at Fig. 3.

TO MAKE AN OPEN FRONT WAX MOULD.—An open front wax mould is one where a part of the profile or back section of a model is left open in the mould, such as a bed mould, where one side or front has a curved outline; for instance, an egg-and-dart enrichment as shown by the back elevation of a model of an egg enrichment at Fig. 6 on illustration No. 89. The model is fixed on a plaster background and on a plaster topground, as shown at F, Fig. 4. This figure shows the model of the egg enrichment and the plaster fences in a moulding box, on a moulding board, during the process of making the wax mould. The model is sometimes fixed on a background only, keeping the back of the model flush with one side of the ground, as shown by the section of the model and ground at Fig. 5. When this method is adopted it is placed in a moulding box and against a plaster topground, as shown at F, Fig. 4. This ground illustrates both methods. If the model was placed in the moulding box and then moulded, the wax would adhere to the wood and spoil the mould, hence the use of the plaster grounds. It will be understood that three or four of the models are jointed and fixed together on the ground so as to make a suitable length for casting, as shown by the enrichment at Fig. 4, which is composed of four eggs and darts, or in other words, the design is repeated four times. The length of the cast must be regulated according to the thickness of the model, or so that the cast will be sufficiently strong to carry its own weight until it is fixed. Having fixed the model on the ground, place it in the moulding box B, Fig. 4. This box must be canted by raising one side until the profile of the enrichment is about level. The box is held in position by means of two clay dots at each end, as shown at D, D. Canting the model enables the mould to be made of a more uniform thickness, which saves wax and enables the mould to be more readily

eased when casting. If the model was moulded in a level position, as shown by the section of the model and ground at Fig. 5, it will be self-evident that the mould would be square, and take about one-fourth more wax than if moulded on the cant. Having fixed the moulding box in position, place a plaster fence on the moulding box and against the ground, as shown at s. This side fence is secured by two clay dots as shown at c, c. This done, fix a clay fence on the end, as shown at E. Fix a clay fence on the other end, and the whole is now ready for the wax. This is, of course, done as previously described.

Having made the mould, a solid moulding piece is next made from it. Moulding pieces that are "made up," that is, where two or more casts of the original model are fixed on a ground to make up a suitable length for casting purposes, seldom stand moulding more than twice, as the prolonged immersion in water when soaking to stop the suction of dry moulding pieces tends to weaken the fixing, and the various pieces generally leave the ground and come with the mould when it is taken off. This difficulty is overcome by making a "solid moulding piece," or an "original," as it is often called. A solid moulding piece is generally made by fixing wooden rules against the sides of the mould as guides for obtaining the thickness and forming straight sides of the moulding piece similar to that described for making the moulding piece of soffit, Fig. 2. But to make a solid moulding piece of bed moulds, similar to Fig. 4, clay or plaster templates are fixed against the ends of the moulds to act as thickness guides and for ruling off. The thickness and form of the moulding piece may also be regulated by the eye, using the end rims of the mould as lines to work from. This is shown at Fig. 8. The dark surface being the mould, and the dotted surface the ground of the moulding piece, the dotted line on the dark surface indicates the profile of the enrichment. When casting, two or more moulds are placed together on a bench or moulding board, and after the plaster is poured in the back and top surfaces are formed by ruling the plaster over with a straight-edge, using the end rims of the mould as bearings. It is here that the open part of the mould and its necessity or use is seen. This side or top of the cast is formed, of course, with a straight-edge, as already mentioned. The section of two moulds as placed together on a bench when casting is shown at Fig. 7. Sometimes four or six and even ten moulds are placed together and filled in at one operation.

TO MAKE A JOINTED MOULD.—Sometimes it is desirable that enrichments should be cast with finished joints, such as when casting with cement, where it is difficult to trim the joints of the hard material with a knife. In this case a jointed mould is employed for producing the jointed cast work. Jointed moulds are useful for producing carton pierre, composition, or any other material where an accurate joint is required, and also for moulding old models that have been previously jointed, or where it is undesirable to use gelatine for moulding. A jointed mould is simply a piece mould on a small scale. The joints of the model, which are of course accurately jointed and without being splayed, are moulded separately, the outside end of the pieces being splayed so that they will allow the other part of the mould to draw when moulding or casting. The method of making a jointed mould in wax is elucidated by Figs. 1, 2, and 3 on illustration No. 90. Fig. 1 shows the moulding piece of a soffit (in the naturalistic style) on a moulding board during the process of making the mould. To make a jointed mould, first make a plaster piece at one end, as shown at p, Fig. 1. The piece is made about $\frac{1}{2}$ inch higher than the surface of the model, and then splayed down to the surface so as to allow it to draw; the piece is raised so as to give it a bed and thus prevent it moving in the front part of the mould. Joggles are sometimes sunk on the piece for the same purpose, but the raised method is best for this work. The ends and sides of the piece are also splayed. As the ground of an ordinary moulding piece is not wide enough to admit of a

sufficient width for the plaster piece and a rim for the front piece of the mould, the ground at the ends must be extended temporarily with plaster before the plaster pieces are made. The size and form of one end of the ground, before it is extended, is shown at *o*. Having made the two end plaster pieces, fix the plaster side fence, *s*, on one side, and then the clay fence, *c*, on one end; repeat this on the other side and end. It is now ready for being moulded in wax in the usual way. Fig. 2 shows a cross section of the mould on a moulding board, and Fig. 3 shows a side section at one end of the mould; the dotted surface shows the section of the plaster piece. When casting, the mould is filled in with the desired material, and when set the mould is turned over and the front or main part of the mould taken off, and then the end pieces are withdrawn, thus leaving the jointed cast. The sides can be jointed in a similar way.

TO MAKE A SURFACE MOULD.—Occasionally a few circular casts of enrichments, of the same design as used for straight parts of the work, are required to fit a ground circular on section, such as a soffit enrichment in a vertical moulding on a coved ceiling, or on the intrados of an arch. The circular casts are readily produced by the aid of a surface mould. A surface mould is somewhat similar to a front mould, but with the exception that it has no rims, the want of which enables the mould to be bent to any desired section. The method of making a surface mould is elucidated on illustration No. 90. This shows the moulding piece of a soffit (in the naturalistic style) on a

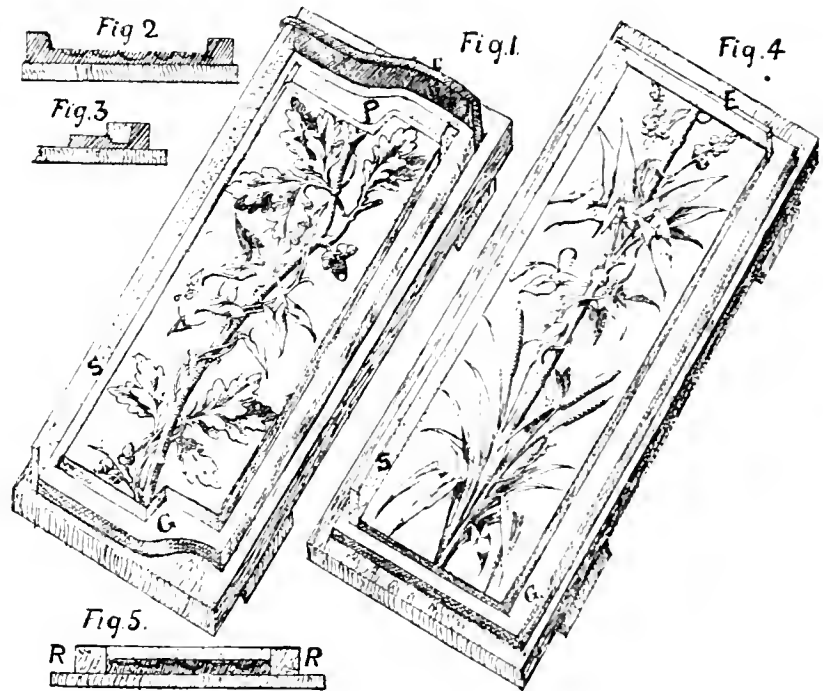

NO. 90.—FIG. 1.—MAKING A JOINTED WAX MOULD.
FIG. 4.—MAKING A SURFACE WAX MOULD.

moulding board during the process of moulding. To make a surface mould, lay the moulding piece as used for straight work on a moulding board as shown at Fig. 4. After this fix the plaster fence on the ground, *g*, of the moulding piece, and against the side of the model as shown at *s*; then fix an end fence in a similar way against the end of the model as shown at *E*. Repeat this on the other side and end. The model, or rather its surface, is now ready for moulding with wax, which is done in the usual way. It will be seen that by fixing the fences against the sides and ends of the model instead of fixing them against the sides and ends of the ground of the moulding piece, as done for a front mould, that only the surface of the model presents itself for the wax mould. After the wax is poured on, the moulds should be "bled," or the deep parts scooped out, so that the sunk parts will make a rough kind of a joggle for a plaster case which is used to keep the mould in position after it is bent. After the mould is taken off it is laid face downwards

on a circular ground which is made to the desired curve. The mould is then pressed down until it fits the circular ground, and then a plaster back is formed on the mould so as to keep it in position. The mould with its plaster back is then turned over and laid on a bench, and then plaster or wood fillets or rules are fixed at the sides and ends so as to form rims to the mould, after which it is ready for casting. Another way for bending and using the mould for casting, which is useful for small work, is effected by making the mould without a plaster back, and then laying it on its back while still pliable, on a circular ground, made to the reverse of the proposed section. Wood or plaster rules are fixed against the sides and ends of the mould so as to form rims. The mould is then filled in while it is lying in the reverse circular ground. It will be understood that the mould must be in this position every time it is filled in. A cross section of the mould and cast is shown at Fig. 5. The dark part is the wax, R, R are the rules which form the rims of the mould, and the dotted surface indicates the plaster cast.

TO MAKE A FRONT AND BACK WAX MOULD.—Front and back moulding with wax is a method generally employed for moulding models that are perforated, such as top-leaf running ornaments or ornaments for coved members in cornices, also for ornaments that are splayed on the edge, such as a top leaf, a patera, or a small rosette. A front and back mould consists of two pieces, as its name implies. The model is backed up with clay to divide it into parts, and form a ground for the first or front piece. The front piece, of course, forms a ground for the second or back piece. The accompanying illustration No. 91 elucidates the method of making a front and back mould. To illustrate the method a perforated cove enrichment, as shown at Fig. 1, is taken. This shows the model on a moulding board. *s* is the section. This enrichment is about 5 inches wide, and with the design repeated three times, is about 12 inches long. Fig. 2 shows the model with the ground fence and a part of the side fence ready for pouring on the wax for the first mould. *g* is the ground fence, *J, J* are two of the four joggles, *s* is the side fence, and *c* is the end fence. Only one side and end fence is shown, to allow the section of the ground fence and the joggles to be seen more clearly. The method of "backing up" the model and forming the fences is as follows:—First fill up the perforations in the model with moulding clay, pressing it in from the back with the fingers until it is flush with the back surface. After this, lay the model on a moulding board, and back up the sides and ends with clay, so as to form the "ground fence" all round the model, and in a line with the various curved edges of the foliage and bands of the enrichment. This is the most important part of the process, for unless this fence is made in a line, and flush with the line or edge which divides the front and back sections of the model, the front piece will not draw, and *vice versa*. For instance, if the fence was made below this edge, the front piece would not draw; and if made over the edge, the back piece would not draw. It may here be mentioned that where the profile extends over the centre of the sides of a model, such as the outer side of a top leaf, the fence must be made as far up or down at this part as will allow the front piece to draw, the remaining part of the profile being of course made in the back piece. The clay grounds in the perforations, which were pressed in from the back of the mould, are made flush with the edges in the same way as used for the outside part of the fence. It must be clearly understood that the clay when smoothed off is not left quite level with the edges of the model, but that it is kept nearly $\frac{1}{16}$ inch below the edges to allow for the wax shrinking, also to form a margin at the edges on the casts, to act as a guide when trimming and jointing the casts. Wax that is soft in nature is liable to shrink when cold, therefore if the fence was flush with the edge, the mould would form a seam on the profile of the cast, which would distort the outline of the foliage after it was trimmed off. The surface of the ground fence is made fair and smooth with a "small tool" and a soft wet brush. The points of

one's fingers are most useful for smoothing the clay grounds in the perforations. These surfaces are finally smoothed with water, not oil, as already mentioned. The sides of the ground fence at the outsides of the model should be made level, and not follow the section of the model. Level or square sides give a better bed for the back mould, and a more effective bearing for easing the mould when casting. If the sides were made circular, or to the section of the model, the edges of the back mould would be thin and sharp on the sides, which would render them weak and easily distorted, and being circular, would make a poor bearing for easing the mould when casting. The width of the sides of ground fences varies from 1 inch to 1½ inches, according to the size of the mould. Narrow sides do not give a good bearing for easing the mould when casting, and they soon become distorted, and prevent the front and back pieces fitting close together. A width of 1 inch will be sufficient for

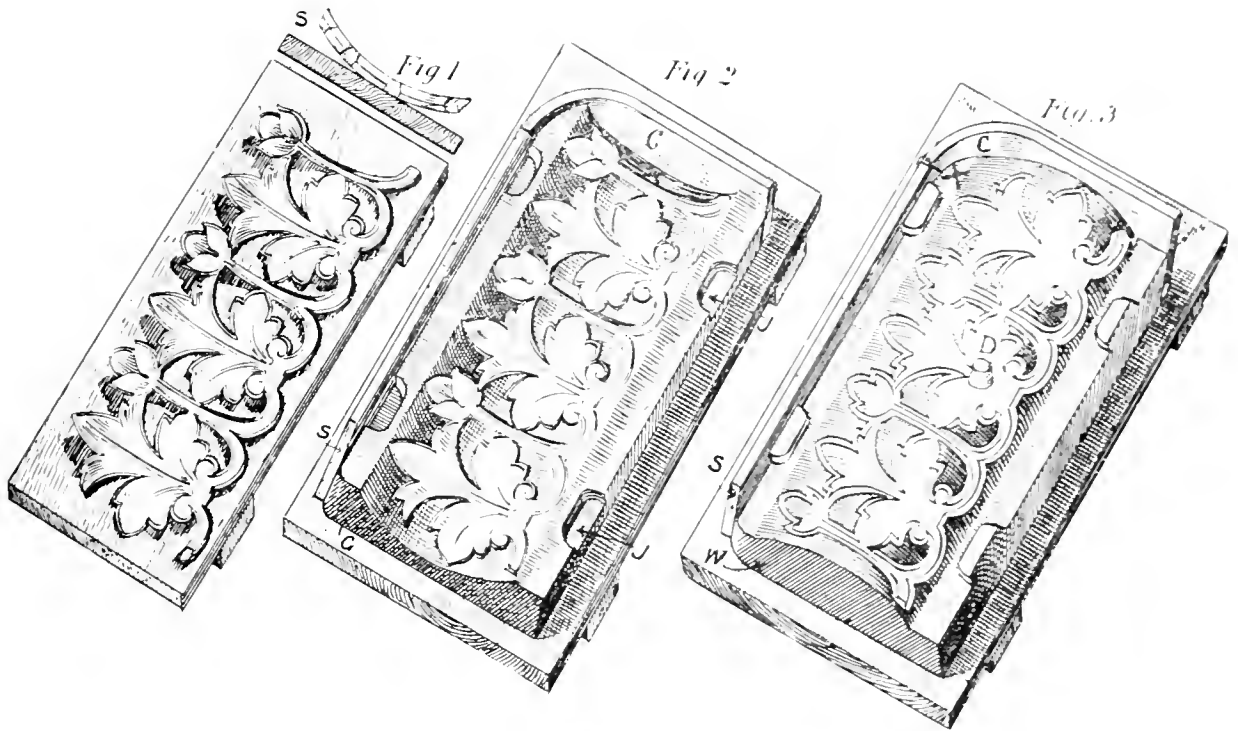

NO. 91.—MAKING A FRONT AND BACK WAX MOLD.

this size of mould. Having smoothed the ground fence, cut joggles on each side of the fence, as shown at J, J.

Joggles should be large in surface and low in depth. Joggles that are small in surface and deep in depth form weak joggles in the back mould. The sides of this mould being 1 inch wide, the joggles should be about 2¼ inches long, ¾ inch wide, and ¼ inch deep. A slight splay about ¼ inch must be made on the sides of the joggles to allow the corresponding ones in the back piece to draw. Joggles with an excessive splay cause the pieces to slip, or "ride," as it is termed in plasterers' parlance, when casting. After the joggles are finished, fix the side plaster fence, S, on the ground fence, keeping it sufficiently high for the desired thickness of the front piece. The thickness of a wax mould should not be less than ¼ inch at the highest points of the model or the grounds of the model. Then fix the clay fence, C, on the end. Repeat this on the other side and

end. The surface of the mould is now brushed with water, and the wax poured on, taking care to pour it on at the lowest part of the ground fence, as at *x*, and following on until all the surface is covered, and to the desired thickness. The section of this model being circular, the wax will be about $2\frac{1}{2}$ inches thick at the centre of the section, therefore to render the piece more pliable, it should be "bled," as already described. When the wax is cold, turn the piece with the model over, and lay it on the moulding board, and clean off the clay. This done, brush the surface of the model with water, and the wax with "clay water," and fix the side fence round the front piece. It is now ready for pouring on the wax for the back piece. It will be understood that the clay water on the wax must be moist while the wax is being poured on, otherwise the wax will adhere to the front piece, and spoil both the front and back pieces. Fig. 3 shows the front piece, *w*, with the model, and one of the side and end fences, *s* and *c* respectively. For large moulds, or where the model is extra thick, a hole in the middle, or one at each end, is formed in the back piece to enable the cast to be more easily pressed out. These holes also allow excess plaster to

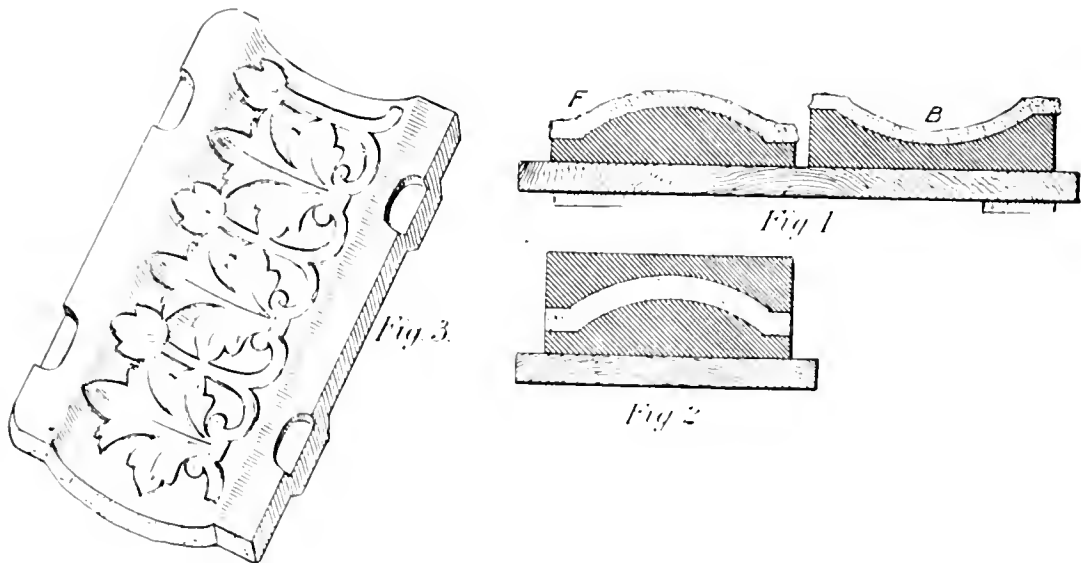

NO. 92. — MAKING A MOULDING PIECE FROM A FRONT AND BACK MOULD.

exude when casting. The mould may also be filled in by pouring the plaster in the holes. The holes are formed by fixing clay dots on the back of the model before pouring on the wax; one is shown at *D*. The wax for the back piece should be poured on at *x*. Wax should always be poured on an original from left to right, to allow the worker to see the work better while pouring the wax on. The front and back pieces are now taken off the model, washed out, and dried; then it is ready for casting. Before casting the ordinary cast work, it is necessary to cast an original or moulding piece for making more moulds, as is generally required, or for future purposes, so as to save the backing up and making ground fences, which would entail unnecessary expense. The method of making an original of this kind is as follows:—

TO MAKE A MOULDING PIECE FROM A FRONT AND BACK MOULD.—The method of making a solid moulding piece—commonly called an original—from a back and front mould, as shown in the previous sketch, is elucidated in the annexed illustration (No. 92). To make the original, first oil the back and front pieces carefully, and lay them side by side; then gauge

sufficient plaster to fill in both parts, also a thickness of about $\frac{1}{2}$ inch over their surfaces. After pouring on the plaster and brushing it carefully, so that the work will be free from "blubs," level the top surface with a gauging trowel, keeping the stuff a full $\frac{1}{2}$ inch above the uppermost surface of each piece, and regulating the thickness by viewing the ends. This is shown at Fig. 1. F is the end section of the front piece, and B is the end section of the back piece. The dotted surface indicates the plaster. Now take up the back piece, turn it over and lay it on the front piece, and press them together until the soft plaster in both pieces is well united in one body, and not less than $\frac{3}{4}$ inch thick. After this clear off any excess stuff that may exude beyond the sides and ends of the two pieces. The sides and ends must be kept flush and square with each other, so as to ensure uniformity in the sides and ends of the original and the subsequent moulds. When the plaster is set, place the work in water for a few minutes to stop the suction of the plaster, which enables the front and back piece to be taken off the original more easily. The complete original is shown at Fig. 3. Moulding pieces can also be made in two parts, one for the front mould and one for the back. This is done by filling in each part of the mould as described above, and then floating the upper surfaces of each piece separately.

WAX MOULDING PLAQUES.—When moulding plaster casts of medals, seals, or delicate plaques, they should not be soaked in water, but set in a flat tray, the water poured gently in at one side until it reaches within $\frac{1}{2}$ of an inch from the top of the cast, and so left to gradually soak through. When sufficiently damp, the face of the cast will appear moist and shiny. It is then taken out and moulded in the usual way. This avoids the oversoaking and spoiling the face of the cast by brushing. This plan may also be used when moulding with sulphur.

WAX PIECE MOULDING.—Leaves or other enrichments having perforations, or undercut at the backs, are moulded in two pieces, one piece for the front and one for the back. This is called a front and back mould. If moulding a leaf, the eyelets and perforations should be plugged up with clay before it is laid on the moulding board. It is then backed up and bedded all round with clay, keeping a wide margin, not less than 1 inch, to give a good surface for pressing the fingers on in easing the mould. A narrow margin soon gets distorted, and prevents the pieces fitting close. The surface of the margin should be kept $\frac{1}{16}$ of an inch below the edge of the face line of the leaf. This is to allow for the shrinkage of the wax, and give a guide when trimming the cast. Make the joggles wide and broad, but not deep. Narrow and deep joggles soon get out of order. Wood joggles about $\frac{1}{2}$ inch by $\frac{3}{8}$ inch thick, and $\frac{3}{4}$ inch long, and then slightly tapered to facilitate their drawing), are sometimes used when wax piece moulding. The tapered end is inserted about $\frac{1}{4}$ inch into the clay margin or fence, thus leaving a projecting joggle when the wax is poured on and the clay taken away. The joggles must be brushed with a solution of clay before pouring on the other part of the mould. Owing to the brittle and porous nature of wax, the joints of wax pieces cannot be cut to the desired form, nor with a smooth surface, therefore the clay fences must be formed fair and smooth for each piece. Each piece should be allowed to be cool and hard, and then brushed with clay water before the adjoining piece is poured on. The method of wax piece moulding a modillion or block is nearly the same as given for plaster piece moulding a block. The only difference is that the fences must be made to the correct form as already mentioned, and that back fences are fixed on the side fences to confine the wax to the desired position and form. Other forms of models are wax moulded on the same principle.

CHASING WAX MOULDS.—Wax moulds may be improved by sinking stems, or other parts, where the clay model has been distorted. The ground or surface of soffit moulds, or other enrichments, having a rough surface, can be made smooth and true by paring the projecting rough parts off with

a sharp chisel, then oiling the wax surface, scraping with a fine drag, and finishing by polishing with fish skin, Dutch rush, or fine glass paper. Wax burs, or projecting pieces caused by the drawing of the wax where parts of the original are deep, are treated in the same manner.

CLAY SQUEEZING.—A clay squeeze is used to obtain a temporary mould, or where it is inconvenient to mould with plaster, wax, &c. The object to be squeezed is first dusted with French chalk, or brushed with turpentine or paraffin oil, to prevent the clay adhering. The clay must be well tempered, beat out in sheets, and rolled until it has a smooth surface. It is then pressed over the work, using the fingers to press the clay into the deep parts, and in close contact with the object. Care must be taken to press the clay uniformly, so that there will be no blubs or creases on the face of the squeeze. If the first piece of clay is not sufficient to cover all the work, cut a clean square joint at the end of the pressed clay, and lay another sheet of clay against the part already dealt with, and press as before, continuing this until all the work is covered. Leave the back of the pressed clay rough to give a key for the gauged plaster that is laid on to keep the soft and yielding clay in position. Float the back of this plaster case with a wet board, so that it will lie straight on the bench.

CLAY PIECE MOULDS.—A clay piece mould is used where parts of the object are too much undercut to allow a squeeze to be taken in one piece. After pressing the clay as described for clay squeezing, back it up with stiffer clay, and cut the joints where the clay pieces are necessary, and brush them with turpentine or paraffin oil before the next piece is laid. Continue this until all the work is covered, and then make a plaster case to keep the clay pieces in position.

PLASTER WASTE MOULDING.—Plaster waste moulding is a method used for moulding clay models on the round to obtain a cast or a moulding piece. A waste mould derives its name from the fact that it must be broken or wasted before the cast can be extracted, whereas a number of casts can be obtained from a piece or "safe" mould. If the clay is firm, it can be carefully coated with thin shellac and then oiled. The shellac must be brushed on with a soft fine brush, so as not to injure the modelling. This gives more freedom in moulding and less fear of injuring the model when fixing the clay fences. The model should not be too dry, as the clay is apt to shrink. If the clay is of a medium firmness, it will not require shellac. An allowance must be made for extracting the clay when the mould is done. This is generally done by making a separate plaster piece at the back part of the model, or where the work is plain, or by making the mould in two halves, somewhat similar to a back and front mould. In moulding a bust, the general way is to make a section in the back or crown of the head. First beat out a sheet of clay about 1 inch thick, and then cut it into strips about 1 inch wide to form fences. Place a clay fence on the head, partly on the crown and partly on the back, in the form of an oval, and as large as will admit the hand to pass into the mould when extracting the clay when it is made. If the fences are laid in an outward slanting position, the piece will draw without taking it off to cut a splayed joint. The water for the first coat of plaster is tinted with red or yellow ochre, to distinguish it from the second coat when chipping the mould off from the cast. The tinted plaster is gauged soft and thrown on with the hand or a spoon all over the mould except the part inside the clay fence until about $\frac{1}{4}$ inch thick. The soft plaster may be put in position by using a soft gauge brush, taking care not to impress or distort the model. When the tinted gauge is set, brush the surface all over with clay water to prevent the second coat from adhering to the first. The second (not tinted) coat is now gauged, allowed to set a little, and laid about $\frac{3}{4}$ inch thick. When this is set, remove the clay fence, trim the edge, and cut two or three sloping joggles; then brush the joint over with clay water. Gauge as much plaster as will cover the oval part level with the top edge of the other section. As

soon as set, sprinkle the mould with water. The top piece is taken off by inserting the point of a chisel at the joint and prizing, thus leaving an opening for extracting the clay. This process is further aided by separating the mould from the stand, thus exposing a large opening underneath. The clay is now carefully withdrawn from the interior of the mould by means of the hands and a wooden tool, clearing the centre out first, until the clay gets thin, when it can be pulled from the face of the mould. The interior is now washed with water and a soft brush to clear any small particles of clay. The mould is then washed with soap water, and afterwards drenched with clean water to clear out any excess soap. The crown piece is replaced and made secure with a string of cord, or temporarily fixed with plaster. It is then ready for filling in. Gauge as much plaster as will cover the face of the mould about $\frac{1}{2}$ of an inch thick, and pour it into the mould, and turn and shake it so that the plaster will cover the interior of the mould. Return any surplus plaster to the basin, and turn the mould again, then pour the plaster back into the mould, and as it will by that time commence to set, it will cling to the mould more readily. Repeat this process until the cast is sufficiently thick without being solid. The separation of the mould from the cast is an interesting and delicate operation, and here the use of the tinted plaster is fully seen, acting as a danger signal to use caution when chipping the inner mould, to avoid chipping or otherwise injuring the cast. With a blunt chisel and a mallet or light hammer chip away the outer or untinted coat of the mould; the thin tinted coat is then carefully and gently chipped or picked off until the cast is clear and clean.

Another way for waste moulding busts or other models on the round, especially if casting an original for jelly moulding, is to place the clay fence across the whole of the bust, so as to divide the model into two parts (as in a back and front mould), keeping the front part the largest, so as to have the joint nearest the back half. Begin fixing the clay fence from the bottom and work up, carve the line of the fence to take the angle of the shoulders, then up to the edge of the ear until the middle of the head is reached. Repeat the same process on the other side until the fences meet on the top of the head. The clay for the fences should be beaten out in strips about $1\frac{1}{2}$ inches wide, and laid on flat (they will lie better this way than if placed on their edge), and another layer of clay is laid on until the fence is $1\frac{1}{2}$ inches thick, to allow a $\frac{1}{2}$ inch for jelly and 1 inch for the case when the original is made. Care must be taken in laying the fences not to impress the clay model. They can be kept in position by pressing pins or fine French nails through the fence and into the model at plain parts; the small pin-holes can be stopped afterwards. When practicable, the fence should be placed on the front half of model, and after the back half has been covered with the tinted and the outer coat of plaster, the model can be laid on its back. This allows the face to be more easily moulded than if standing upright. Three or four oblong joggles are now cut into the plaster margin at each side, and brushed with clay water. A board or plaster ground is then fixed at the bottom or end of the model to prevent the plaster running over, and to serve as a guide for thickness of the waste mould. The other half is now made with the tinted and outer coat of plaster as before. When it is set, the whole of the mould is well sprinkled with or immersed in water for two or three minutes, to stop the suction of the plaster, and allow the mould to be opened and the clay extracted more freely. Lay the mould on the bench with the back part of the model uppermost, and insert three or four thin wood wedges between the joints, taking care to keep clear of the joggles. Drive the wedges gently home with a hammer until the back can be taken off. This can be further aided by extracting as much clay as possible from the opening at the end, and pulling it down until there is little or no clay to offer a resistance to the back coming off. After the mould is separated, the clay cleared out, and the back and front parts washed and soaped, an original is taken out of each

half. After they are seasoned, they are ready for casing and moulding. The advantages of this plan will readily be seen by the practical man. The waste moulding, extracting of the clay, washing the mould, filling in the original, casing and jelly moulding, are all done more easily and quickly when in halves and lying flat than if done upright and on the round; and there is no cutting the jelly at the joints of the case, as must be done when moulded in one piece. This plan of making back and front originals separately will also be found useful in wax moulding. Moulds or cases in halves are best kept together when casting by making two rings of hoop iron, and placing one over each end of the mould, and tightening by means of wood wedges.

MOULDING FROM LIFE.—Masks from the living and dead are often taken and used for models, for busts in marble, bronze, terra-cotta, and plaster. Plaster casts of various parts of the body are also often required as models. Pliny states that Lysistratus, the sculptor of Sicione, was the first to make moulds and masks from the living face, the date being about 328 B.C. Pliny's statement is probably correct as far as he knew; but as already mentioned, Dr Petrie's recent discoveries prove that moulding from life was in use about 1300 B.C.

The novice may begin by experimenting on the hand of a friend. First grease the hand, smoothing the small hairs on the back of the hand, and lay it in the desired position on the moulding board. If the position of the hand is hollow in the palm, support this with clay or rags. Then lay a margin of clay round the hand and fingers. It is not necessary that this be made to "draw," because the flesh will yield when the mould is taken off. Make a few joggles in the clay by pressing the end of the finger or a round tool into the clay margin, then gauge as much plaster with warm water to give less shock and set quicker), and pour over the hand. As soon as this is set, reverse the hand and grease the palm, clay water the plaster margin, and gauge more plaster with warm water, pour on, and when set, take the back and front off, and cast in the way already described. Another way is to grease the hand as before, and plunge it into a basin of gauged plaster. When all the surface is covered, place in the desired position, and as the plaster sets, lay a strong thread on the wet plaster along the hand and down the middle finger and over the point, passing it up the palm to the wrist. Lay another from the wrist to the thumb. Now lay the remaining plaster all over to a sufficient thickness, and when the plaster is nearly set, take the ends of the threads and pull them through the plaster, thus making a piece mould. The hand must be kept perfectly steady. As soon as the plaster is set, and the mould separated at the joints by the threads, the hand is released. The divisions or sections may also be got by laying a waxed thread on the hand where required, but before the hand is greased, the waxed thread will adhere to the hand, if kept motionless.

The face may be next practised on. Lay the living object in a recumbent position, then plug the ears with wool and grease the face, covering the eyelashes and brows with wax, clay, or thick pomade. The beard, &c., should be covered with thick clay paste. Then fix two quills in the nostrils with wadding or fine wool for the purpose of breathing, and tie a towel round the head and neck, close to the back of the ears, to prevent the plaster from running over the subject. Gauge the plaster with warm water, and pour over the face. Another basin of plaster should also be gauged at the same time with strong alum water to make it set quicker than the first gauge). This is poured over the first gauge, and as soon as it is set, and the first gauge nearly set, gently but firmly pull off the mould. The object of having the second gauge to set first is, that it will act as a case for the first gauge, and enable the mould to be taken off just at the time the first is nearly set, without pulling out any skin or hair that may get mixed with the plaster. If the first gauge was fairly set, and any hair or eyelashes got mixed with the plaster, the face or the mould might get injured when being separated. The subject must look pleasant, and not laugh or make faces while the plaster is

being poured on or while setting, or neither he nor the moulder will feel satisfied with the job. If the subject is not impatient, he can turn round after the plaster is set, and before the front mould is taken off, and have the back part of his head moulded. He can then have a cast of his full face and head. The moulder is master of the situation, but he must be careful not to disturb or cover the quills when he is pouring on the plaster, or the mould may be spoilt. Moulding separate parts of the face, such as an ear, nose, or eye, is good practice. Limbs, or even the whole figure, can be moulded with plaster, and casts true to nature obtained. The ordinary way when moulding the face is to use one gauge, but the plan described is best for preventing the hair from being injured. The alum water should be tested by gauging a small pat of plaster, and a small pat of the first gauge laid aside to judge the time of setting. If there are two moulders on the job, there will be more time for gauging, and will also give more confidence in placing and keeping the subject in position. It must not be forgotten to close the eyes of the subject before the plaster is poured on, but the subject will probably do this of his own accord. It takes a more artistic treatment to open the eyes in the plaster cast. The best plan to do this is to take a clay squeeze out of the mould, and open the eyes and touch up the hair on the clay.

PLASTER PIECE MOULDING.—A piece mould derives its name from being made up of a number of pieces which placed together form the complete mould. Piece moulds are used for reproducing metal, terra-cotta, concrete, wax, or plaster casts from original models that are on the round or undercut, and where it is impracticable to mould them in one piece or in two pieces, such as a "front and back" mould. If the seams formed by the joints of the pieces are carefully taken off a cast produced from a well-made piece mould, it will be a fair facsimile of the original model. Plaster lends itself more freely, and is more adaptable for forming a piece mould than either wax, clay, sulphur, or metal. Its quick setting powers and unshrinkable and plastic nature, combined with its fine and smooth surface, seems to be expressly designed by Dame Nature for this purpose.

Plaster piece moulding is about as difficult to explain as it is to learn. This subject, like most if not all subjects appertaining to plaster work, has hitherto not been described, therefore I find myself on an untrodden path, with experience as my only guide. I will, however, endeavour to explain, in simple trade phrases, the process from the beginning to the end. Piece moulding is undoubtedly an important and useful branch of the plasterer's craft. A vast amount of piece moulding is also done in terra-cotta work. A good piece moulder often obtains remunerative employment in sculptors' studios, also in Government, educational, and surgical institutions, in piece moulding antique figures and architectural examples for museums and art schools. Numerous and important examples are to be seen in the South Kensington Museum. Up to the early fifties plaster piece moulding of figures for sculptors was chiefly done by Italians. Since then British plasterers have frequently been employed on this important branch of the plasterer's craft. T. Worrall, a Scotch plasterer, and O. Cullen, an Irish shop-hand, and several others have been exclusively engaged on figure moulding in London. Plaster piece moulding is in daily use in plasterers' shops for moulding vases, capitals, and similar models; and in terra-cotta work for moulding all kinds of models, including figures, are solely done by British workmen. The greater employment of terra-cotta, artificial stone, and fibrous plaster during the last generation has given a great impetus to piece moulding, which has by the increased and more general practice enabled the native moulder to equal his foreign rival in point of quality, and excel him in point of quantity. Plaster piece moulding is an art requiring considerable practice and care. A piece mould is made in numerous sections, so contrived that the several pieces can be taken off, one after the other, without fracturing the model or the cast. The pieces are kept in position by the aid of a plaster case. In a few

instances, where the pieces are large, few, and simple, no case is used, the pieces being bound together with string, wire, or hoop-iron. Roman joints or joggles are used to secure separate parts of the mould together. A good piece mould is known by the close and firm joints, and by the ease in taking every piece off the cast. It should be light but strong.

None but the best of plaster should be used for piece moulding. Where practicable, the piece in hand should be completed in one gauge, so as to ensure equality in setting, swelling, and strength. Several gauges are generally required to make a case. The addition of lime putty water to the gauging water will improve the ultimate strength of the case. Lime putty water should not be used in the gauges for the pieces, as it will cause the oil to peel and "fur" when casting. The moulding piece or model should be clean and sharp. If otherwise, the mould and the resultant casts will be dull and blunt. A piece mould can be taken from a plaster model in a "green" state, *i.e.*, newly made or unseasoned, but it is advisable to season it with linseed oil or with shellac, so as to stop the suction. The method of seasoning plaster models is precisely the same as described for seasoning plaster moulds. When piece moulding a green model with plaster, use a solution of soap for lubricating the surface, to stop the suction and prevent the pieces adhering to the model. Do not soap all the surface at once, but only as much as will serve for the first and adjoining pieces, and so on until the whole of the model is moulded. Stearic solution, as already described, may be used for this purpose.

The surface of models that are seasoned with linseed oil or shellac are generally oiled with sweet oil. Suet solution is also an excellent compound for oiling models. It can be brushed on so as to leave a very thin coat on the surface of the model. This is an advantage, as the thinner the coat of oil is, the sharper and truer will the plaster piece turn out. Suet solution does not soil the model, but tends to indurate it and season the plaster pieces. The joints should not be brushed with oil, as this clogs and makes wide joints. Brushing them with soap solution not only prevents cohesion between the pieces, but also enables close joints to be made.

Besides the ordinary shop moulding knives, a "moulding hammer" and a "joggler" are required. Moulding knives are used for cutting the joints. They should be strong, long, and sharp, and of various sizes, as described in Chapter XXI. A moulding hammer is used for tapping pieces to make them fit close to the model after they are trimmed, and for tapping them so as to loosen and enable them to be taken off when they adhere to the model, also for tapping the case when it adheres to the mould. A "moulding hammer" is shorter and heavier than a "lathing hammer," and has a large flat head. This hammer being heavy and flat-headed, enables the piece to be more effectively tapped and with less force than a light and narrow-headed hammer, and also with less fear of injuring the piece or the model. A "joggler" is used for making sunk circular joggles. It is made out of an old stiff putty-knife or an old chisel, the end being rounded off or shaped like a flat V drill. To use it, place the point on the desired spot, and hold the handle between the hands, and then turn the handle sharply backwards and forwards. For ordinary or temporary work, joggles can be sunk with the point of a gauging trowel. A fine drag for levelling or smoothing the back of the pieces, and a coarse drag for smoothing the case and cutting off sharp angles, are useful. A dusting brush is also necessary for cleaning the model and the pieces. Moulding boards or turnbats are also required, to form a stand for the moulding piece, and allow it to be turned round when moulding the various sides or ends.

Before beginning the mould, beat out a sheet of clay about $\frac{1}{2}$ inch thick, to make "fences" for forming the pieces to the desired sizes and shapes. The oil and solution should also be prepared and tested before the work is begun. The term "oil," or "oiled," as used hereafter in describing the

method of piece moulding, includes the use of soap and suet solutions, each being used for the different parts and classes of work as already described.

When moulding an original or a model requiring many pieces, the size and shape of each piece should be decided on and set out by the eye. In some models it is advisable to trace or faintly mark the size and shape of each piece on the model with a soft pencil; care being taken that each will "draw," otherwise it or the model may be fractured. The size of the pieces depends entirely on the class of work on hand; it must be regulated, so that each piece may "draw" freely. When the size and form of the various pieces have been carefully thought out, and found practicable, proceed to form the pieces. If the model is on the round, such as a pedestal or a figure, begin at the bottom, and work upwards. This method enables the first tier of pieces to support the pieces above. Make a fence with a strip of clay about $\frac{1}{2}$ inch square, and to the required length. Lay the fence on the model, and at the outline of the proposed piece, then oil the surface and lay the plaster as already described. When the stuff is set, take off the piece, and trim the joint, and replace it on the model, taking care that it fits close and true. A close fit may be obtained by gently tapping the back of the piece with a moulding hammer. The pieces are got off the model also by gently tapping with a moulding hammer, and then pulling the piece off in a direct line from the model, or according to the angle of the part that is being moulded. This process is continued until the whole of the model is moulded. The case is then made. A case for flat work is generally made in one part, but for work on the round, such as a figure vase, the case requires to be made in two or more parts, so that each will draw off the mould. The various parts of cases with their several pieces are put together, and the whole bound with hoop iron, and tightened with wedges, or tied up with strong string or sash line.

Piece moulds having many pieces require each piece to be numbered, or distinctive marks or joggles to be sunk on the backs. This gives greater ease and speed in placing each piece in its proper position in the case. The joggles also assist in keeping the pieces in position. The size of the pieces depend on the size, form, and class of work in hand, and may vary from one superficial inch to one superficial yard, but whatever size is made it must be regulated, so that the piece will draw freely, and without fracturing the adjoining piece or the model. Small pieces are more easily taken off the cast, because there is not so much suction as in large ones, but small pieces should not be made just for the sake of making a larger number of pieces in a mould. The larger the model, the larger the pieces, that is to say, if there are two models of the same subject, one large and one small, the pieces on the large one would be proportionally larger.

Models are sometimes piece moulded direct from the original clay. For this class of work it is necessary to indurate the clay surface by coating it once or twice with a thin solution of shellac before moulding the model. Plaster piece moulds for the production of carton-pierre casts, such as centre flowers, have the upper edges of each piece trimmed off from $\frac{1}{2}$ to $\frac{3}{4}$ inch deep, and when the edges of the pieces come together, these form a flat V sinking, and a corresponding raised part in the case when made. This keeps the pieces in position, and prevents them from being moved. This plan is also useful for other moulds, but if the model is circular, or on the round, care must be taken that they are splayed to allow the case to draw. When there are deep or thin parts on the model, the plaster pieces are strengthened with perforated sheet zinc, or wire inserted in the plaster before it is set. The last piece made is called the "closing piece," and as it requires no trimming, it is not taken off until the case is made.

It is a good plan in large work to arrange the pieces in sections, in order to have a closing piece in each section, because not being taken off until the case is made they make closer and

better joints than the pieces that have to be taken off, trimmed, and replaced. When the case is made and taken off, the closing pieces are taken off first. This allows the other pieces to be taken off in rotation or in the reverse order to that in which they were made. The closing pieces have a looped ring, commonly called an "eye," inserted in their centre before the plaster is set. The eyes are intended to give a hold for pulling the pieces off. These eyes are made of copper or galvanised iron wire, cut in 5 or 6 inch lengths. One piece is taken and bent over the tapered handle of a medium-sized tool brush until the ends meet. The ends are then twisted until there is a stem about $\frac{1}{2}$ inch long, then bend the two ends in opposite directions, and at right angles to the stem, pull the piece of wire off the handle, and the eye is ready for insertion. The eyes are inserted in the centre of the desired pieces, just as the plaster begins to set, leaving the head or ring projecting above the surface of the piece. Before making the case all the eyes must be covered with clay to allow it to draw. This makes a sinking in the case, and when the latter is taken off, the sinking is cut through, leaving a round hole about $\frac{1}{2}$ inch in diameter. The piece is then taken off the model, the clay cleared off, and a piece of strong waxed string about 12 or 15 inches long passed through the eye, the ends being left about equal in length. The piece is then offered up, and the string passed through the holes from the inside, and tied on the outside over a small bar of wood. The bar is made about 2 inches long and $\frac{1}{4}$ inch square, with the edges in the middle slightly notched to prevent the string from slipping. The string is further tightened by means of a wedge. When the mould is filled in, the string is untied and drawn out. The case can then be taken off, leaving the piece on the model, while leaving the piece on the mould when moulding, and on the cast when casting. Eyes are also used for pieces that project at an angle, or any deep parts, where the pieces cannot be held in the case, or are liable to fall out, while the mould is being turned over.

When the joints of a piece are being trimmed, the angle should not be too acute, but there should be just as much splay as will allow the next or abutting piece to draw. Joints cut with too much splay give thin sharp edges to the piece, which make bad joints, and are more liable to get chipped than a nearly square joint. The joints in many moulds might be cut square, if it were not for the swelling of the plaster while the mould is being made, and also in the cast when casting. This plaster expansion binds the pieces firmly together, and makes it difficult to take the pieces off the mould and the cast. When the casts are made the seams caused by the joints of the pieces should be cleaned off while the work is "green." Seams are taken off with Dutch rush, fine scratch-tools, or fine raffles or files. They are further smoothed with a piece of fine flannel. Fish-skin is an excellent material for smoothing large surfaces. It resists the effects of water and wear for a long time.

TO PLASTER PIECE MOULD A MODILLION.—Having committed the foregoing notes and details to memory, the novice had better try his "prentice han'" on some simple model, such as a plain modillion, or "block," as it is termed in plasterers' parlance. The method of piece moulding a block is elucidated in the accompanying illustration (No. 93). Fig. 1 shows the original or moulding piece of a block. B is the block, and G the ground of the moulding piece. Having beaten a lump of clay into a sheet, cut a few strips from 2 inches to 3 inches wide to form fences for the upright parts, also cut a few strips about 1 inch wide for the top fences. One edge of the narrow strips should be cut on the slant, to give a splay to the plaster piece which is to be formed against it. The end pieces of the mould are made first, one at a time—a smart and efficient workman can make two in one gauge, the sides next, and the top last. Cut one of the narrow clay strips to the length of the end of the block and lay it on one end, keeping the slanting cut outwards and in a line with

the arris of the block as shown at T, Fig. 2. After this, cut one of the wide clay strips to the desired height of block, including the top fence, and fix it on the side and to the arris or mitre of the block, and at an angle of 45 degrees, close up to the arris of the block. Repeat this on the other side, then cut them in a slanting form, so as to leave them about 1 inch wide at the top and in a line with the ground, as shown at S, S. When fixing the clay fences, take care that the arris of the block is neither covered nor left too much exposed, because if it is covered the piece will be short, and the next piece will project over the arris and damage it; and if too much is exposed, the piece will get over it with the same result. This is an important part in piece moulding, and if the clay fences are carefully put on at the edges and proper slope, the joints will not require much trimming, and there need be no fear of fracturing the original or the piece when moulding or the cast when casting. This applies principally to arris or undercut work, and where it is not advisable to take off the piece to

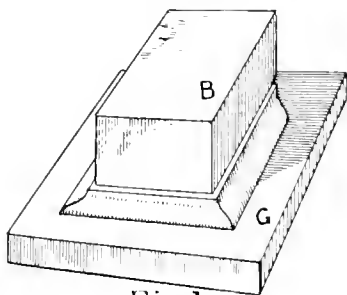

Fig 1

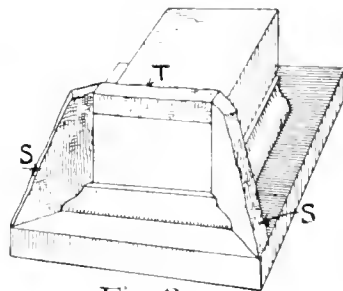

Fig 2

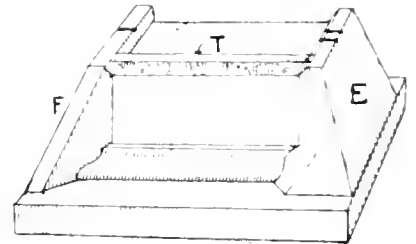

Fig 3

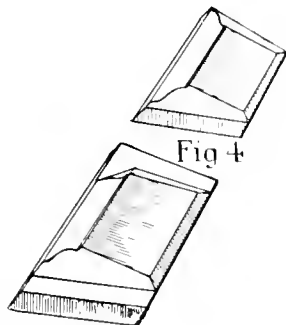

Fig 4

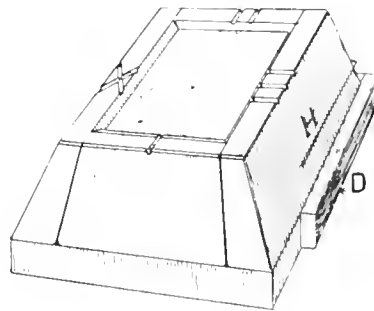

Fig. 5.

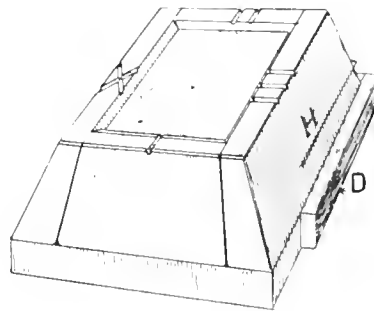

Fig. 6.

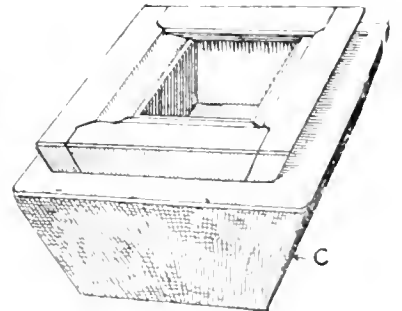

Fig 7

NO. 03.—PLASTER PIECE MOULDING A MODILLION.

trim the joint, but for general work the clay fences may be placed about $\frac{1}{8}$ inch outside the line or pencil mark of the proposed joint. The excess plaster is then cut and trimmed to the true joint. A joint well trimmed with a good knife makes a truer and closer joint than if made with clay. Still clay is indispensable to form a fence and a rough joint. Joints should not be cut at too great a slope, but just splayed sufficiently to allow the piece to be drawn off the adjoining piece or *vice versa*. The surface of the piece to be moulded is next oiled, and then the plaster is gauged and laid on with a small gauging trowel or a spatula. If there are deep places or angles on a model, the soft plaster may be slightly spread into the interstices or angles with a tool brush, but the plaster should not be dabbed in with the brush, as when the brush is drawn back after each dab it draws away a portion of the plaster, leaving air spaces which cause the face

of the plaster to be full of holes, which in plastic parlance is termed "blubs." If the plaster is spread with the brush, the air is driven off, leaving a solid face. A solid surface is further ensured by pressing the remainder of the plaster firmly and evenly into the space with the gauging trowel, until the piece is made up to the required thickness. The side fences act as guides for the thickness, and the top fence for the height. The back of the piece is made as fair and smooth as possible before the plaster is set, and any imperfections or ridges are made good, and cut or worked fair with a drag after the piece is taken off.

The process of fixing the clay fences, oiling and filling in with plaster, is repeated on the back end. While the plaster is setting, take off the first piece and trim the joints, and cut off the sharp edges at each side formed by the side fences, so as to form a square side or "shoulder," to prevent it sliding when in the case, and to form a stronger joint and interlock with the adjoining piece, thus preventing the several pieces from falling inwards when in the case. A view of the piece when trimmed and jointed is shown at Fig. 4. The form and use of the shoulders will be seen by the sketch of the complete mould at Fig. 7. Having trimmed the piece, replace it on the original, and keep it in position with a clay dot until the side pieces are made. The other end piece will now be set and fit for trimming. This is done in the same way as for the first piece, taking care to form the shoulders at each side without cutting the joint of the projecting part formed by the mitred part of the cyma-reversa moulding. A view of the back end piece is shown at Fig. 5, and a plan of the shoulders at Fig. 7.

The side pieces are next made. This is done by laying a narrow strip of clay on the top of the block, and from the front to the back pieces, as shown at Fig. 3. F is the front piece, and L is the back piece, and T is the top clay piece. The side is then oiled, and the plaster laid and trimmed, and jointed at the top edge. This edge must be splayed to allow the piece to be drawn out of the case. The splayed edges form a rebate in the case, and prevent the piece from slipping inwards. The form of the splayed edge for this and the other pieces is shown in Fig. 6. The thickness of the side piece is regulated at the top by keeping the outer edge of the soft plaster parallel with the clay fence, and by keeping the stuff flush with the ground, also by observing the thickness at the ends. This will be better understood by viewing Fig. 6, which shows a perspective view of the original with the end and side pieces. The thickness of the side pieces can be accurately regulated by fixing a clay fence on both end pieces, allowing the ends of the fence to project to the edges of the ground, and then cutting them to the desired slope at the ends, thus forming fences and guides or bearings when filling in the side pieces. The other side piece is made in a similar way as the first side piece. A distinctive mark or joggle must be made on the top edge of each piece, as shown in Fig. 6. These joggles are cut with a knife. Joggles give a ready guide for placing each piece in its own place in the case. They also prevent the pieces from shifting sideways in the case. It is advisable to make the joggles or figures, as sometimes used on each piece, according to the order in which they are to be placed in the case when casting. Where there are numerous pieces in a piece mould, this method saves time and annoyance in finding the various parts and places. In this example the pieces are marked as a means of reference according to the order in which they are made, but in practice the side pieces are placed first in the case, and then the end pieces. If the end pieces were placed first, it would be very difficult to place the sides afterwards. This applies more especially to the back end piece.

Making the case is the next and final part of the process. For small work like the present example, the top piece of the model and the case is made together or in one piece, and in one operation. A top or other piece that will draw, made this way, is said to be "made in the case."

For best or intricate work it is not advisable to make a piece in the case, because the case is more liable to get injured than the pieces, and in the event of the case being broken while casting, a new case can be easily made. But it would be more difficult to do this if it forms a piece or part of the mould. The case for the present example need not be made to cover all the sides of the pieces or extend down to the ground, but a space about 1 inch deep left clear, as indicated by the line at H, Fig. 6. This space not only saves materials, but also forms a useful handling point for lifting the case off when casting. The readiest way to form this space is by means of a fence, which is laid on the moulding board and against the sides of the four plaster pieces. This fence may be made with clay strips, or with thickness rules. This fence should also be made to the desired thickness of the proposed case, as they also act as guides when making the case. If the case was required to extend to the ground, and cover all the surface of the pieces—as is necessary when there are several small pieces in the sides of a mould—thickness rules must be laid around the mould and level with the ground, so as to act as a fence to form the case level with the mould and as a guide for regulating the thickness of the case. A part of a thickness rule is shown at D. Hand holes, to enable this form of case to be readily taken off the mould when casting, are made by fixing a clay dot on the fence at each end of the mould. The clay dots should be cut about $2\frac{1}{2}$ inches long, $1\frac{1}{2}$ inches deep, and as wide as the fence. Where the ground of an original extends beyond the plaster pieces, clay dots similar to the above, and fixed on the ground and against the side and end pieces, can be used for regulating the thickness of the case as well as for forming hand holes. Having fixed the space fence at H, fix a small clay dot on the top of each of the four pieces, keeping them clear of the joggles. The object of these dots is to form guides for regulating the thickness of the case. The holes allow for dust to escape when brushing out the case. It will be seen that these dots are made and used for a similar purpose as described for the dot D, Fig. 3, illustration No. 91. After the case is made, the dots are extracted. The original and the pieces are then oiled, and then the plaster gauged and laid on. The plaster should be laid carefully, yet quickly. To do this, first pour a little of the plaster over the work, then lay the remainder on bit by bit with a gauging trowel, until the top and the ends and sides are formed fair with the trowel. The top surface is levelled with a wet board, which is worked in a circular motion and before the plaster is set. The sides and ends may be further smoothed with a drag. The case and the pieces are then taken off the original and dusted, and any blubs or defects made good, and the whole seasoned by coating with shellac or oil as required. It is then ready for casting. Fig. 7 shows the complete mould, with the four pieces and the case C.

If the top or face of the block was moulded or ornamented, it would be necessary to form one or more separate pieces. Assuming there is a top piece, first oil the original and the upper edges of the side and end pieces, and then form the top piece. The thickness can be regulated by the joints of the side pieces. As there is no joint trimming required, the top piece is not taken off, but the top surface and edges are made fair and smooth with the trowel and drag. The case for this example is made somewhat different to the first mould, where the top piece is formed in the case. For this example, place a dot about 1 inch wide and $1\frac{1}{4}$ inches deep on each corner of the top piece, keeping about $\frac{1}{2}$ inch from the outer edges. The object of these clay dots is to regulate the top thickness of the case, and to allow the cast and pieces to be gently tapped or pressed through the holes, also to allow dirt or dust to be brushed out when casting.

TO MAKE A MODEL OF A BALUSTER.—Before describing the method of piece moulding a baluster, it will be in proper working order to describe the method of making the model of a baluster. The model of a baluster circular on plan is made in three pieces, and then they are fixed

together. The body, which is circular on plan, is turned in a lathe, in a similar way as described for scagliola columns. The top and bottom plinths, which are square on plan, are made out of a block of plaster or in a mould made by fixing four rules together. The latter is the easiest way. When fixing these parts together, take care that the plinths are level and square with each other, and that the body is central. A slight draft should be formed on the inner surface of the plinths to allow the mould to draw. Models of balusters are also turned in wood. In this case the plinths and body are formed in one piece. Balusters that are square or octagonal on plan can be run in one piece. This is effected by fixing running rules on a moulding board to the desired plan, then with a twin-slipped running mould, running the various sides in an upright position and in one operation. A core should be previously fixed on the board as a bearing for the plaster.

TO PLASTER PIECE MOULD A BALUSTER.—Plaster piece moulding a baluster is a simple yet useful example of moulding a model on the round or without a ground. The most difficult part in moulding a model that is spherical in form, such as a ball, or one that is circular on plan, such as a plain vase, or a round baluster, is to find the centre line, so as to divide the model into equal halves,

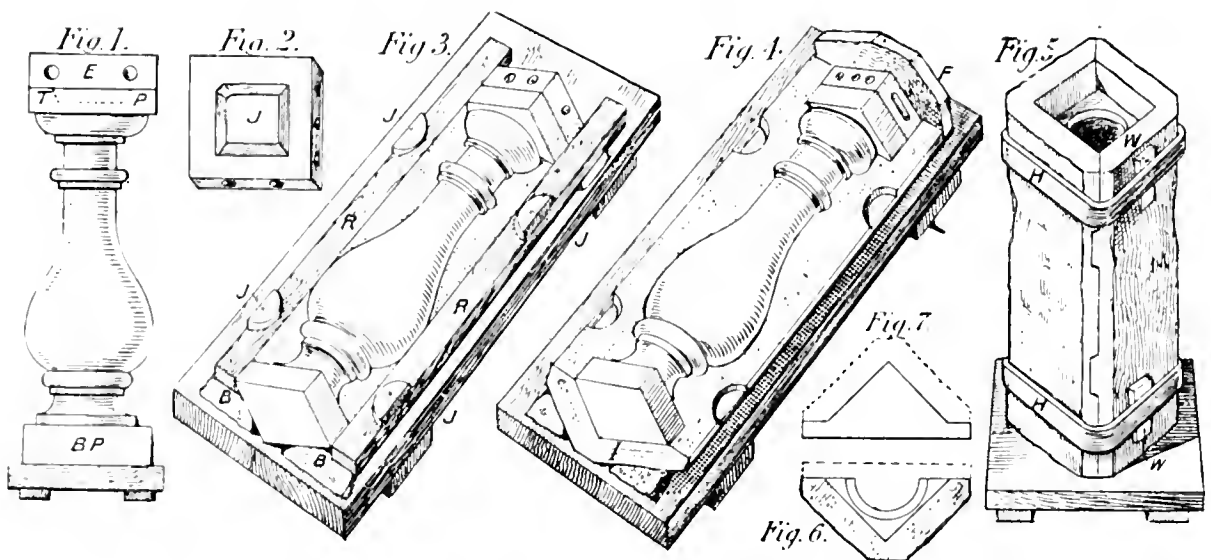

NO. 94. PLASTER PIECE MOULDING A BALUSTER.

to allow the mould to be made in two side pieces. The centre line is used as a guide for forming a fence for the first side piece. The top and bottom plinths of a baluster being square on plan, their diagonal angles present ready and accurate points for obtaining the centre lines. This and the method of piece moulding a baluster will be seen in the accompanying illustration (No. 94). A baluster is generally moulded in three pieces, one end piece and two side pieces. The end piece, E, is made first, and on the top end of the baluster, as shown at Fig. 1. This figure shows an elevation of a baluster 2 feet in height; T P is the top plinth, and B P is the bottom plinth, both of which are square on plan, as already mentioned. Before the end piece is made, a joggle about 1 inch deep should be sunk on the top of the model, as indicated by the dotted line on the face of the top plinth. This joggle is made for a twofold purpose—first, to keep the end piece in position while the side pieces are being made; and second, to form a sunk joggle or key in the casts for fixing purposes. This joggle can be made either round or square, but it should be irregular in the outline at one angle, so as to form a distinctive mark

to enable the piece to be readily replaced on the model after it is trimmed. Fig. 2 shows a plan of the inner surface of the end piece, with the raised joggle, J. The end piece is made by fixing a fence on each of the four sides of the plinth, keeping them flush with the sides and equal in height to the proposed thickness of the piece. The thickness may vary from $1\frac{1}{2}$ inches to 2 inches, according to the size of the baluster, but it should never be less than $1\frac{1}{2}$ inches, so as to allow a sufficient width for the joggles to be sunk on the sides, and the necessary strength requisite for its purpose. Having fixed the fences, the model is oiled, and the gauged plaster poured on, and the upper surface made level with the fences. After the stuff is set, the piece is taken off, trimmed, and the joggles sunk. Joggles different in form or number should be made on each of the four sides, so that the piece can be readily placed in its proper position in the mould when casting. They should also be well defined in depth and outline, so as to form a strong joint with the side pieces. A joggle that has a broad surface and low depth will form a stronger joggle in the adjoining piece than one that has a narrow and deep surface. It will be seen that these joggles constitute the only means of supporting the piece in the mould, hence the necessity of making them strong. In some districts the end piece is not made as a separate piece, but it is made in a case, the latter being also used to hold the side pieces in position as a substitute for the bottom hoop, but this method is not so safe as the hoop and wedge. The model with the end piece is now laid longwise on a moulding board, keeping two of the angles of the plinths vertical, and then supporting and holding the model in position by inserting a block of clay at the angles, as shown at B, B, Fig. 3. Two similar blocks are inserted at the top end, taking care that they are long enough to support the model and the end piece. These clay blocks are also used for supporting the two wooden rules, R, R, which form a part of the side fences. These rules vary from $1\frac{1}{2}$ inches to 2 inches wide, according to the size of the baluster or required strength of the mould. These fence rules must be fixed exactly in a line with the arrises of the top and bottom plinths, and level crosswise with each other. The spaces between the rules and the outline of the model is made up within $\frac{1}{4}$ inch of the upper surface of the rule with bits of old plaster, wood, or clay, and then gauged plaster is poured on these rough parts. The surface is then made smooth and flush with the rules by the aid of a small joint rule, using the fence rules as bearings. It will be seen that this process forms a fence at each side, true to the centre of the baluster.

The formation of joggles for the side pieces is the next part of the process. As it is difficult to sink joggles in the wood rules, it is better to make raised ones. This is done by cutting blocks of clay, each about $2\frac{1}{2}$ inches long, $1\frac{1}{2}$ inches wide, and $\frac{3}{8}$ of an inch thick; then place two on each of the fences, as shown by the four J's. An angle iron for each end is cut to the desired length and bent to the angle. Angle irons are used to strengthen the angles of the mould. They are inserted about $\frac{1}{2}$ inch from the ends of the side pieces. The form of one is indicated by the dotted line on the end of the side piece at I, Fig. 4. The model and fences are now oiled, plaster poured on, and the angle irons inserted. The sides of the piece are of course regulated by the edges of the side fences, also the thickness at the angles, and the ends, are regulated by viewing the end of the model and the end piece. The thickness and form of the piece can also be regulated by fixing a wood or plaster fence at each end of the model. The form of one is shown at F, Fig. 4. The angles are squared off so that the pieces will lie steady on the bench while being oiled. The side piece, with the model and end piece, is then taken up, turned over, and laid on the moulding board, as shown at Fig. 4. It is then dusted, oiled, the gauged plaster laid on, the angle iron inserted, and the sides formed, as described for the first piece. This done, the pieces are taken off the model, and any defects made good, and then they are ready for casting.

A baluster square on plan, called a "square baluster," is piece moulded the same way as described for the circular baluster. Octagonal balusters generally require four side pieces, but if the sides of the baluster are panelled, eight pieces will be required. Enriched balusters require more or less pieces according to the design. The pieces are made on the same principle as described for "piece moulding a vase." Cast-iron moulds have been used for casting Portland cement balusters, but unless for very large quantities their price is prohibitory. "Spence's metal" has also been used for making piece moulds of balusters, but although suitable for some moulding purposes, it is too brittle in nature for large and heavy work of this kind. An improved metal, made on Spence's principle, is well adapted for making piece moulds for casting Parian or other white cement balusters.

DUPLICATING PIECE MOULDS.—If a number of moulds be required, they should be duplicated by moulding and casting, instead of making each piece. To duplicate the mould, take a moulding piece out of each piece. To do this, place one of the side pieces flat on a bench, and mould it. An end section of the piece is shown at Fig. 6. The dotted line indicates the section of the cast mould. After this, lay the mould in a similar way, and cast as many of the side pieces as required. The other side piece is duplicated in the same way. An end section of the mould is shown at Fig. 7. The dotted line indicates the section of the cast of the side piece before it is taken off the mould. The end pieces are made by placing two side pieces on the original model, and after fixing them with the hoops and wedges, filling in the vacant space with gauged plaster, repeating this until the required number of pieces are made, thus duplicating the complete piece moulds. The end pieces can also be made by piece moulding the first one. This is done in two pieces and a case. The first piece is made from one diagonal angle to the other, similar in form to the end section of the side pieces. The other side is of course the same in form. A case is then made over the two pieces, thus completing the mould. A similar method of duplicating the pieces of a piece mould, whether plaster, wax, or sulphur, may be advantageously employed for modillions, caps, and many other plastic purposes.

CASTING BALUSTERS.—The moulds, which have been previously seasoned, are opened and laid on a bench, then the pieces are oiled, and then placed together on end (with the end piece at the bottom) on a casting board or a bench, as shown at Fig. 5 on illustration No. 94. The side pieces, with the end piece, are held together with a square hoop made of hoop iron at the top and bottom, as H, H. The hoops are tightened by means of wedges, as W, W. The mould is now ready, and in its proper position for filling in. After the mould is filled in, the cast is ruled flush with the edge of the mould, and a rough joggle formed in the end of the cast for fixing purposes.

TO PLASTER PIECE MOULD A VASE.—A vase is chosen as a final example of piece moulding, as it presents several features for illustrating various parts of piece moulding that are used for other models that are "on the round," such as figures, busts, fountains, &c. This form of model also serves to illustrate the method of piece moulding models "on the flat," such as panels, centre flowers, medallions. The profile of most vases are partly oval or in the form of an egg-cup. These are generally moulded so that the case can be made in one piece. A vase with a profile that is somewhat square and projects near the centre is here given, so as to illustrate the method of moulding a model on the round that necessitates the case to be made in two parts or halves. A vase consists of two parts, the "foot" and the "body." The foot is generally cut off the body of the model, and the two parts moulded separately, and when the casts are made they are fixed together. This is the best way where the foot is high or narrow, or too weak to carry the body until fully set, as there is less chance of breakage than if the vase was cast in one piece. For large or heavy work

the foot and body are best moulded separately, so as to facilitate the ease of casting and handling. If the model is of average size, or the foot short and sufficiently thick to give ample strength to carry the body while being cast, the vase should be moulded as a whole. The latter method is used for the present example, as shown in the accompanying illustration No. 95, which gives the elevation of a vase during the process of being piece moulded; one half is moulded, and the other is in progress. The vase is about 2 feet 6 inches high, and 2 feet in diameter at the "lip" or top. The darts at s indicate the height of the foot or stand, and the part above is the body of the vase. The mould for this form of vase is made in two equal sections, one for each vertical half of the model. A case for each section is also required. A section with its case is made first for one-half of the model, and then the section with its case is made for the other half, and

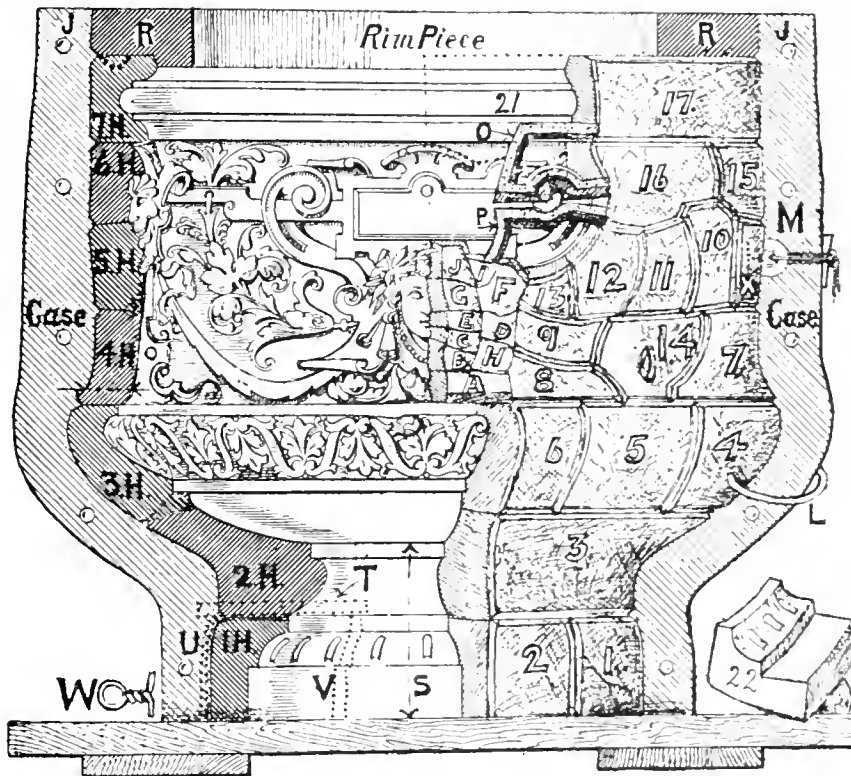

NO. 95.—PLASTER PIECE MouldING VASE.

against the two ends of the first section, as indicated by the illustration. Nos. 1 H to 7 H are the ends of the pieces at one side of the first section of the mould. The ends of the pieces at the other side are of course covered with the end pieces of the second section of the mould. The sketch also shows the inside elevation of the rim piece with its ends, R, R. This piece extends around the first section from end to end, and is made in one piece so as to keep the lower pieces in position. This is further secured by means of joggles which are made in each of the top row of the adjoining pieces, one of which is indicated by the dotted line at 7 H. The rim piece is made to lay over the lip or top of the model, so as to give a ground for regulating the thickness of the casts while casting. The sketch also shows both ends of the case for the first section with the joggles, J, J, which are used to hold the case of the second section in position.

To piece mould the vase, first divide the circumference into two equal parts, and from these points make a vertical line on each side of the model. These vertical lines are used as guides for making the first and second sections of the mould equal, so that the case for each will draw off freely. The vertical lines should be made where there is the least amount of ornament, as it is easier to clean off seams on a plain surface than seams on ornamental parts. Fewer and larger pieces can also be made on plain parts. Large pieces lie better than small ones at the ends of the cases. It will be seen on the sketch that the grotesque face, being plain and flat, requires only two pieces at each side, whereas the female face, being prominent and more fully enriched, requires six pieces for the half or side. Having made the vertical lines, proceed to piece mould the first half of the model. The method of doing this is similar to that used for the second half, with the exception that clay fences are fixed on the model at the vertical lines to form the ends of the pieces of the first section of the mould, whereas the end pieces of the second section are made on the end pieces of the first section, as shown by the illustration. Figs. 1 II to 7 II are the end pieces of one side of the first section, and the pieces, Nos. 1, 3, 4, 7, 8, 15, and 17 are the end pieces of the second section which are made on the end pieces at the other side of the first section. The method of making the first section of the mould will be gathered from the description given for the second section, which is as follows:—

Begin at the bottom of the model and work upwards, so that the lower pieces will support the upper ones, until the case is made. Also work from the vertical joints towards the centre of the model. To make No. 1 piece, first fix a narrow clay fence on the joint of the first case, following the contour of the piece in the case, then fix a vertical clay fence on the model, and then fix a top fence to connect the two vertical fences. The position of these fences will be seen by the dotted lines on the other side of the model. U indicates the narrow fence, V the vertical fence, and T the top fence. A narrow fence is made at this part, because it is only used as a guide for forming the thickness of the piece at this side. If made wide, there would be an extra thickness of plaster to trim off to make the piece flush with the back of the adjoining piece. Wider fences are used at the vertical and top sides, as they form the joints as well as the thickness of the piece. The dotted lines U and T will also serve to illustrate the method of forming fences for the first piece of the first section of the mould. Take the dark surface, 1 II, as a clay fence at the main vertical joint, which, with the fences V and T, would form the complete fence for the first piece of the first section. Having fixed the fences for No. 1 piece, oil the surface, fill in space with plaster, and form the back of the piece with a gauging trowel, and when set, take the piece off, and cut the joint at the case until flush with the back edge of the piece in the case, and then smooth the back with a fine drag. This done, cut a splay about $\frac{1}{4}$ inch deep on the upper and left hand edges of the piece; the use of these splays will be seen when the adjoining pieces are made. The vertical edge at the case must not be splayed but left square, to form a level or flush joint to allow the case to draw. After this fix a vertical and top fence for No. 2 piece, and then fill it in as before. The back of this piece is made smooth and flush with the adjoining piece by the aid of a drag. It is then taken off and the vertical and top edges are splayed as before. After this fix fences for No. 3 piece, fill it in, trim the back and splay the edges, as described for No. 1 piece. The vertical splays on the right-hand side of the pieces which are near the main vertical joint of the mould must be made flatter than the left-hand sides, so as to allow the case to draw. This method would of course be reversed on the other side of the mould.

It will be seen that the splays form sunk V-shaped joints, as shown by the vertical joint between Nos. 1 and 2 pieces, and the horizontal joint between these pieces and No. 3 piece. These

sunk joints form corresponding raised divisions in the case as shown by the sketch, which assist in keeping the various pieces in their proper positions in the case. V-joints are principally used for piece moulds that are used for producing carton-pierre casts, terra-cotta work, or where stiff gauged cement is used. The raised divisions prevent the pieces from moving, while these materials are being pressed in the mould to form the cast. It will be seen that two pieces, Nos. 1 and 2, are used for the half of this section, while only one piece, No. 3, is used for the half above. The reason for this is, that the flutes on the moulding would not allow one piece to draw freely, and that No. 3 piece being on a plain part enables it to draw in one piece. The pieces Nos. 4, 5, and 6 are next made in the order named, and in a similar way as described for the lower pieces. This part of the model requires three pieces for two reasons—first, because the circumference is greater at this part than below; second, that this part being enriched, more pieces are required to allow them to draw off the repeated ornament. It will be seen that the horizontal joints of Nos. 2 and 3 pieces are made on plain parts, or near the centre of members of the moulding, but the horizontal joint of No. 6 piece is made at the arris of a member. The former way makes better joints than the latter, because the seams on the subsequent casts are more readily and truer cleaned off on the profile of a member than a seam on an arris of a member. The top horizontal joint of No. 6 piece is drawn this way purposely so as to show the defect more clearly, also to show that a joint should always be made to give sufficient strength at the edge of the piece. If the joint of No. 6 was made in the centre instead of the arris of the member, the piece would be too weak at its upper edge; this will be better seen by comparing the full section of a similar piece at 3 H. It will be observed that the thickness of the piece between the joint and the projection of the ornament is already too small for practical use, and if made in the centre of the member, it would be still thinner, consequently weaker and less useful. A stronger piece and a better joint would be obtained by making the piece larger with the joint at the dotted line, between the darts 4 H.

Having made the third tier of pieces, the pieces from Nos. 7 to 14 are next made. This is done in the order named, and in a similar way as described for the lower pieces. The joints of these pieces should be made, where possible, on plain parts of the body, or at the arris of a scroll or band, or where most suitable for the piece to draw at undercut parts of the model. It will be understood that these items regulate the size and form of each piece, as mentioned in the notes on piece moulding. It will be seen that piece No. 14 is in the centre of the pieces mentioned above. The latter piece is made last, so as to form a "closing piece." A closing piece is made at the centre of a series of pieces, so as to bind the surrounding pieces, and make closer joints. A closing piece is not taken off until the case is made. The splayed joints are cut *in situ*. A closing piece is sometimes used to support the surrounding pieces after the mould is made. When used for this purpose, a wire eye is inserted in the middle of the piece, as shown. A "wire eye" is also used for pieces that project in the mould to prevent it falling before the mould is filled in. The method of using this is shown at M. Although not absolutely necessary for the piece x, the wire is shown here, as being the best place for illustrating its use. The elevation of a wire eye is shown at W. The method of making this has already been described. The fangs of the eye are inserted into the piece before the plaster is set, leaving the eye protruding, as shown at M. The eye is covered with clay to allow the case to draw. The clay should be a little larger than the projection of the ring, so as to allow space for tying a string on to the ring, as indicated by the half circle. After the case is made, a hole about $\frac{1}{2}$ inch in diameter is bored through the case with a gouge. A string is then tied on the eye. The ends of the string are then carried through the hole in the case, which are in turn tied over a wood bar or wedge, which is laid across the hole on the outside of the

case, as shown, thus preventing the piece from falling inwards. It will be understood that the piece X and the case at M are taken for the time being to illustrate the method of using a wire eye. A closing piece may also be made in the form of a "wedge piece," so as to act as a support for the surrounding pieces to prevent them falling inwards or out of the case before the mould is filled in. This is effected by making the surrounding pieces first, and splaying the joints that are next to the proposed wedge piece inwards instead of outwards, as used for the other sides of the pieces. The intermediate space is then filled in, and a wire-eye inserted in the middle of the surface, thus forming the wedge piece. This piece is then tied with a string, and secured on the outside of the case as already described.

The pieces Nos. 15 to 17 are next made, and in the order given, and as already described, for the other pieces. The top piece, No. 17, must be made to extend above "the lip," so as to form a "shoulder piece" to form a bond with the rim piece. The pieces lettered from A to H are next made, and in the order given. The piece H is used as a closing piece, but without a ring. The pieces I and J are next made in the order given. The joints of the lettered pieces are not splayed at their upper edges, but are left square, thus forming "flush" joints. Flush joints are generally used for small work, also for pieces that have a deep projection in the case, or where sunk joints would prevent the case drawing off the pieces. The projection of the face in the centre of this part of the model gives a good bed for the pieces in the case, hence the reason for making flush joints at this part. The fences for the next pieces to be made (Nos. 18 and 19, are shown at O and P, respectively. These pieces being small, may be filled in with one gauge. After this a fence is fixed across the ends of these pieces, and then the intermediate piece No. 20 is made. This done, the piece No. 21 is made, the form of which is indicated by the dotted lines. It will be seen that this piece comes over the moulding, so as to take in the back part of the centre and side scrolls, which surmount the plain oblong panel. This enables the projection of the scrolls to have more relief than if they were "stopped" down to be moulded in one piece. With the exception of a piece for the oblong panel, this completes half of the second section of the mould. The other half of the mould is made precisely in the same way.

The fences indicated by the dotted lines at U, V, T are used for the first piece. This is shown when taken off to be trimmed at No. 22. The intermediate space at S is then made, and so on as before until the whole side is finished similar to the other half. The plain panel, with part of the scrolls, is then made as a closing piece. Joggles are then sunk on each of the top pieces, and then the rim piece is made. This is made in one piece, as already mentioned. Joggles are now made in the ends of the first case to receive the second case, which is next made, thus completing both sections of the mould. It will be understood that the figures from 1 to 17 and the letters from A to J are sunk on the backs of the pieces, to afford a ready guide for placing them in the case while casting. The other letters and figures on the ends of pieces and the case are simply used as references for describing the method of moulding.

Pieces that project on the model, similar to No. 4, are liable to fall by the force of gravitation, and are supported until the case is made by fixing plaster dots on the joints, so as to obtain a support from the adjoining pieces. These dots are oiled before the case is made, and after the case is made they are then released from the pieces by tapping. Projecting pieces are also held in position by the aid of wood props. The props may be removed while the case is being made, or they may be left in and the projecting ends sawn off after the case is made. Projecting pieces are also supported by means of a "link," as shown at L. This link is simply a piece of rod iron, from $\frac{1}{4}$ inch to $\frac{1}{2}$ inch thick, bent to the form of a half link or a half oval ring. It is bent a little less in

width from the points than the desired fixing points on the pieces. When fixing, it is then opened a little and allowed to spring back on the fixing points. Links are also used for holding a piece in position while the adjoining pieces are being made, so as to ensure true and close joints. A vase that is egg-cup shaped is generally moulded so that the case will draw in one piece. This is effected by cutting the foot off, then moulding it and the body separately. A rim piece is made first on the top of the body, then both are inverted, and then the other pieces made, thus allowing the case to draw in one piece.

CASTING VASES.—When casting vases in Portland cement or fine concrete, the thickness of the body is regulated by means of a wooden template, which is inserted on a pivot fixed on the moulding board if the mould is open at both ends. If a separate mould is used for the body, a pivot is fixed in the centre piece at the bottom for the template to work on. The template may also be formed to work in a hole made in the bottom piece. If the mould is open at both ends, the template is made to work on the rim piece at the top and the case at the bottom. If the mould is wide and low, so that all the surface may be got at, the cast can be filled in while the mould is in an upright position, but the safest way is to fill the mould in by sections. This is done by laying the mould on its side, then filling in about one-third of its circumference, and when set turn the mould over so that another third can be filled in. This is repeated until the whole surface is covered. The joints of each section must be left a little thinner than the proposed thickness of the cast, so as to allow the following section to lap over and strengthen the joint. Moulds that are made in two sections, similar to the example shown in illustration No. 95, are more easily filled in. Each section is laid foot to foot on a bench. They are then filled in, and when the material is nearly set they are raised on end and placed together, and then secured at the foot with a rope and at the top with an iron hoop, both of which are tightened by the aid of wedges. The joints are then made good, and the thickness of the cast regulated as already described. The method of casting with Portland cement is described hereafter.

OILING PLASTER MOULDS.—Plaster piece moulds are generally oiled with a mixture of Russian tallow and sweet oil. Lard with and without sweet oil is sometimes used. The addition of paraffin oil to these oils renders them more soft, cleaner, and freer to work. Soft soap alone, also mixed with sweet oil, is preferred for some purposes. Plaster being of a porous nature, and containing a proportion of lime, is easily affected by soaps, fats, or oils. The fatty acids unite with the lime and render the face of the mould and cast sticky. This causes dust to accumulate, and in time to form crusts in the deeper recesses, which are difficult to remove. German plaster moulders overcome this by the use of finely separated stearic acid. One part of stearic acid or stearine is melted in a water bath, and about 5 parts of alcohol or benzine is added, in which it dissolves to a clear solution. By shaking as it cools the acid will be obtained in a fine state of division, forming a kind of magma with the alcohol. This is used for oiling the mould, and in a short time the alcohol will evaporate, leaving a thin film on the mould, and allowing the cast to be readily taken out covered with a thin imperceptible film of non-adhesive stearate of lime. This stearic oil is also useful for jelly moulds. Animal oils develop acids, vegetable oils become gummy. By the admixture of mineral oil (preferably paraffin) these qualities are neutralised. Temporary moulds, intended for two or three casts only, are not seasoned, but are thoroughly saturated with water and then oiled with a solution of soap.

SUET SOLUTION.—Suet solution is an excellent compound for oiling models when plaster piece moulding. It will also be found a ready and useful oil when casting in wax and sulphur moulds. Suet solution is made by dissolving fresh mutton suet by gentle heat, then adding as much paraffin oil as will keep it in a soft creamy state when cold.

SOAP SOLUTION.—This solution, or soap water, is made by reducing soft soap with boiling water to a creamy consistency. It is used for plaster waste moulding, also for the joints when plaster piece moulding, and several other shop purposes. Soap water should not be used for washing old or dry plaster moulds or casts, as it leaves a thin sticky film which attracts and retains dust. They should be dry dusted, and then washed with warm water and wiped. They are then ready for oiling.

STEARIC IMPERVIOUS SOLUTION.—This solution will be found useful when plaster piece moulding, and for the moulds when casting special works, such as antique and classical figures, panels, &c. By its use, sharp, clean, and white casts are obtained. A neutral soap of stearic acid and caustic soda is prepared and dissolved in about ten times its weight of hot water. The models and moulds are coated by being either brushed with or immersed in this solution. By this process the colour of the moulds is not affected. It is rendered impervious, and permits the moulds or casts to be washed, even with lukewarm soap water. Stearate of potassium is only soluble in hot water. As already mentioned, soap water leaves a film on the surfaces of moulds, which attract dust. The same difficulty is presented by plaster that has been impregnated with a solution of alum and stearine. A solution made with stearate of alumina in benzole behaves in the same way. The plaster can also be made impermeable to water by washing it with a solution of oleic acid in benzine. This is applied cold, and the casts must not be washed with soap water, as it would take up the oleic acid. The best way is to wipe them with a cloth moistened with the acid. The stearic acid and caustic soda solution gives the best results, and it may be used for waterproofing plaster casts.

OILING WAX MOULDS.—The oiling of moulds is an important feature in the production of clean and sharp casts. Oiling moulds is a simple thing, yet it requires attention to avoid waste of oil, injury to the mould, and blunt and discoloured casts. Olive or sweet oil is generally used for oiling wax moulds, and gives good results for general purposes. Russian tallow, lard, and mutton suet is also used for oiling wax moulds as well as for plaster moulds. Animal fats are too hard to work freely. If they are thinned down by adding paraffin oil, as already described, they work cleaner and more freely. The fats should be dissolved by heat, and then sufficient paraffin oil added until of a creamy consistency. Chalk oil is also used for wax moulds. Moulds composed of rich wax will yield a few casts without oiling by simply brushing with soap water and then rinsing. Wax that has been seasoned by using a few times gets a certain quantity of fat or oil incorporated through the oiling of the moulds, which is retained by the force of the water, and does not require oiling for every fill-in. If they are oiled once a day they will yield clean and white casts. New moulds after being oiled should be well washed with soap water to remove any superfluous oil and ensure clean and white casts. Oil is often spoiled by being kept in open oil pots; a self-closing pot is made as follows:—

BALL OIL-POT.—Most shop-hands will have noticed that the old method of dipping the oil brush into an open oil-pot is a source of waste of oil, and that the open pot is a harbour for dust and dirt. To avoid these evils I have introduced the "ball oil-pot," which, by means of a ball, practically closes the pot, while allowing the oil to be obtained in regular quantities. It is simple and cheap in construction. First procure an old sardine tin of medium size, and an earthenware or glass ball. The diameter of the ball should be about double the depth of the tin, so that when placed in the tin one-half of the ball will project above the lid. Now cut a circular opening in the centre of the lid. The diameter of the hole is made slightly larger than the diameter of the ball, so that it will admit the ball to revolve freely. The lid may also be hinged on one side, and

made with a clasp on the other, to allow the pot to be cleaned out when necessary. When the pot is filled with oil, the oil brush is pressed on that part of the ball above the lid, which causes it to revolve and take up a certain quantity of oil, and as the brush only takes up the oil that is on the surface of the ball, it can be applied to the mould with greater regularity and more uniformly than by dipping the brush into an open oil-pot, and overcharging it with oil, and swamping that part of the mould where laid, thus causing unnecessary wear by dipping for the excess oil that is lying in a body, destroying the face of a delicate mould, and leaving the oil unevenly spread, which obliterates the fine lines in the mould and causes blunt casts. The use of the ball oil-pot will be found to effect a great saving of oil. It is also quicker, cleaner, and more regular and economical than the old method.

GAUGING PLASTER.—Gauging plaster is one of the most common, but important tasks in connection with plastering. Nevertheless very few know how to gauge properly, though it is a simple operation. Gauging plaster properly is not only the primary but also one of the principal parts of most plastic processes. Plaster should always be kept in a box, having a lid to keep out dust and damp. The box should be placed on a stand about 2 feet high. This will save unnecessary stooping, exertion, and time. Stooping and gauging out of a plaster sack is slovenly, wasteful, and tiring. A "slush tub," as already mentioned, is also requisite. The water should be clean and fresh. Dirty water impairs the strength of the plaster when gauged, also the whiteness of the cast work. In order to avoid waste or extra gauging for one fill-in, the water should be measured for repeated work. For this purpose, a pint measure should always be placed handy at the water tub. Where practicable, the mould should be filled in with one gauge to ensure solidity and equal expansion. This applies more especially to solid cast work, but in fibrous work, or when the plaster is gauged with size water, this is not so important. The quantity of plaster used for any special job may also be ascertained by measuring the water before gauging. It takes about 2 lbs. of plaster to 1 pint of water to make a gauge of medium stiffness. After measuring the water into the gauge pot, lift the plaster with the hand, or with a small tin scoop, and lightly but quickly sprinkle it all over the water. Continue this until the plaster appears at the surface. When all the water appears to be taken up, and there is no dry plaster on the surface of the water, it is then quickly stirred up with a gauge stick for large quantities, and an iron spoon or a gauge brush for small quantities. This method, if properly performed, prevents air bubbles and lumps in the gauge. The desired consistency is also easily obtained, therefore no added water if the gauge is too stiff, also no added plaster if the gauge is too thin, is required. Adding water or plaster after the material is gauged weakens the ultimate strength of the plaster. This is caused by the extra work which the plaster is subjected to by extra stirring or gauging. The stirring should be done quickly but not long, because excessive stirring tends to kill the plaster. Excessive water and working will destroy the setting and hardening of the best made and strongest plaster. It is a well-known fact that many plasterers when finishing the stopping of the joints of cast work, and wishing to match the white colour of the neat plaster casts, use neat fine plaster, and literally work it to death by continuous working and adding water. This is truly termed "killed stuff." Plaster gauged with clear size water would answer equally well for this purpose. Size water retards the setting, and to a certain degree hardens plaster, but no amount of size will make or keep an overworked plaster strong. Even if the plaster is gauged quick and stiff with size water, it will become weak if excessively worked.

As already stated, the practice of adding more plaster to that already gauged is wrong, because it creates additional heat and swelling, thus injuring the mould, and rendering the cast difficult to

extract. It also tends to cause warping in the casts. Plaster for cast-work should not be gauged too stiff; a thick creamy consistency, just sufficient to allow it to run freely into the intricate parts of the mould being the best for obtaining solid and hard casts. Plaster swells and gives off more of its latent heat if it is gauged thick, or in other words gauged with more plaster than the water will readily take up. The extra swelling, as above stated, makes it difficult to take a cast out of the mould, and it is apt to burst a plaster mould. Clean pots and water for every gauge is indispensable. Old or liquid plaster in a fresh gauge weakens the cast work. Lime water furs the moulds, and causes the casts to adhere, and be difficult to extract. For a final example of the difference between plaster that is gauged slowly, thin, and excessively worked, and plaster that is gauged quickly, stiff, and sparingly worked, a practice of everyday work may be cited. Many plasterers will have noticed how hard plaster becomes that has been gauged by simply soaking in water. This is often done on the blade of a trowel for stopping purposes. If the plaster is not kept too long in soak it will only take up the minimum of water, or as much as will moisten it; and as there is no stirring or working, the setting properties are left free and undisturbed. Even if the plaster is left in the water for hours, it will be found harder than a soft gauged or overworked plaster. The stiffer plaster is when gauged, the denser and harder will be the resulting work. Plaster that has been gauged soft (*i.e.*, with an excess of water) is much more porous, and has consequently far less wear and durability in it, than if it had been gauged stiffer. For fine cast work, plaster should not be gauged too stiff, otherwise it is difficult to brush it into the crevices of the mould, and it is also apt to burst the mould by expansion. Expansion is greater in plaster that is gauged stiff than in plaster that is gauged soft. Plaster is to a certain extent soluble in water. About 1 part of plaster will dissolve in between 400 and 500 parts of cold water. It will be seen from the foregoing that plaster should be quickly gauged, moderately stiff, and sparingly worked for all plastic purposes where strength and durability is a desideratum.

USES FOR OLD PLASTER.—In shops where a large trade is done, the waste gauged plaster, old cases, originals, grounds, and slush often accumulate in large quantities, and make a considerable item in cost for cartage. The old dry plaster may be converted into a bastard plaster or Parian for gauging coarse stuff or similar purposes, by soaking it in a strong solution of alum, borax, or vitriol, then calcining in an oven, and afterwards grinding. Old plaster is sometimes used to fatten mortar by grinding them together in a mortar mill. Slush (the thin killed plaster washings of gauge pots) may be turned to advantage by converting it into "hearth blocks" for whitening hearths, jams, &c. This is done by pouring off the excess water and mixing the sediment with coarse plaster, and putting the mixture in wood or plaster moulds, made to any desired size. When dry, the blocks can be sold for hearthstone purposes. Old or dirty clay can be used up in the above mixture. Old plaster is also used in the manufacture of artificial manure. Enormous quantities of old moulds, casts, and models are thrown away as useless when done with, or are simply used for whitening floors and the like. In 1889 a patent was obtained by a Nottingham firm for the "utilisation of old waste plaster moulds or casts." The waste plaster is broken up and reburnt in a kiln (it must not be "dead burnt"); it is then drawn from the kiln, cooled, and pounded up or ground; it is then ready for use.

PLASTER CASTING.—The antiquity of moulding and casting in plaster is beyond doubt. That the art of casting in plaster was not unknown to the ancients is clearly proved by such an example as the figure of Eros, from Egypt, in the British Museum. Recent excavations by Dr Flinders Petrie, at Tel-el-Amarna, brought to light many interesting architectural remains. Tel-el-Amarna is situated on the Nile, Egypt. It was founded by Amenhotep IV. about 1400 B.C.

Besides the floor and ceiling plaster already mentioned, Dr Petrie also found a number of plaster casts, the plaster being a coarse greyish gypsum. This plaster work consisted of a number of objects in cast plaster for building decoration, and slabs with hollowed portions, probably to be filled up with inlaying, also of slabs with inscriptions in low relief. None of these objects showed tooling or hand work. They were all cast, with the exception that in a plaster cast of the king's face (probably cast from a mould taken after death), the outlines of the eyes were tooled to make them distinct. The dates are well authenticated by historical records. These plaster relics reveal to us the state of the craft at a period of 3,300 years ago, a date anterior to the Exodus, 500 years before the building of Solomon's Temple, and more than 900 years before the age of Phidias.

Plaster casting out of wax moulds has been greatly improved during the last generation. Formerly the moulds were oiled for every "fill-in," and if out of a front and back mould, the back was swamped with oil to make the cast come out easily. This constant oiling was a direct waste of time and oil. It also caused the casts to have a yellowish appearance, and they had to be placed in the sunshine to make them white. The first and second casts were the most yellow, and when extra white work was desired, and there was no sun, they were in some instances destroyed. The moulds were also placed in front of a fire to render the wax more pliable for easing. This was also a slow process, and as the moulds were not uniformly warmed, they were hard to ease, and consequently the cause of much broken ornament. The introduction of warm water for rendering the moulds pliable was a decided improvement. The following is the most modern and effective way of producing good plaster casts:—

After oiling the mould and washing it out with soap water, the plaster is gauged as already described. A small portion is poured over the mould, and then it is brushed all over the surface and into the deep parts and angles, so that it will expel the air and fill every part on the surface. This brushing in of the liquid plaster must be done quickly and uniformly, using the brush to push the plaster over the surface and expel the air, so as to avoid blubs and seams on the face of the cast. The plaster must not be dabbed with the brush, because the brush takes up a portion from the surface and admits the air, which causes blubs. Dabbing tends to make the surface of the mould rough, and also work the surface oil into the plaster, thus making the cast more difficult to take out. If the mould is small, the plaster may also be forced into the cavities by blowing it with the mouth or with a bellows, and also by violently shaking the mould. If the plaster is properly brushed in, it will suffice for all purposes. As soon as the surface is brushed in, the remainder of the plaster is poured on and pressed in with a brush or a gauging trowel. The upper surface is then ruled off flush with the mould rims, and then the fixing surface keyed with a scratch drag. When the plaster is set, or nearly so, the mould is placed in warm water for about five minutes, or until the wax is sufficiently warm or flexible to admit of its being eased without cracking. It is then taken out and eased or sprung to release the cast. This is done by holding the mould with the hands and pressing the rim with the thumbs. This is continued until all the rim is eased and sufficiently sprung to allow the cast to be easily drawn out. Thick or deep casts are more difficult to draw out of the mould than thin or shallow casts. In this case the mould should be turned face downwards and violently shaken, or the rim gently beat on the edge of the bench. If the mould is too large or heavy to be turned up, lay it solid on a bench and gently prize the cast up with the aid of a chisel. When casting small enrichments, place about six moulds close together, side to side, and fill them all in one operation. If the wax is well tempered, and the atmosphere warm, the moulds may be immersed in cold water. All cast work should be trimmed before the plaster is

dry. Thin or tender casts are strengthened by inserting splints of wood or cane, reeds, rushes, string, canvas, or galvanised wire in the plaster before it is set.

HOLLOW CASTS.—When casting large work, the casts should be made hollow, the thickness of the cast depending on the size of the casts and the purpose for which they are intended. The casts may be strengthened by inserting rod iron or strong wire. The iron should be warmed and dipped into or rubbed with wax to prevent it from rusting and disfiguring the plaster. Hollow casts are made by pouring in a portion of gauged plaster into the mould, and shaking and rolling it so that the plaster may go into every part of the mould. Pour the surplus plaster into the basin, and keep turning the mould over until the plaster in the basin shows signs of becoming firm, then pour it into the mould and keep turning the mould. Another gauge should now be poured in before the first is set, continuing this until the cast is sufficiently thick. When the mould is too heavy or large to be conveniently rolled or shaken, suspend it with ropes from the ceiling, or lay it on a bed of old bags or shavings to facilitate the shaking and rolling without injury to the mould.

FURRED MOULDS.—The surface of wax moulds sometimes becomes coated with a white substance known as "fur," which adheres to the cast and makes it difficult to leave the mould. This fur is caused by there being lime or sulphur in the plaster. When a mould becomes furred, it should be washed out with clay water or with sugar water. Furring may be prevented by mixing a little brown sugar with the oil used for the moulds.

STRONG PLASTER FOR CAST WORK.—Plaster is often gauged with glue water to retard the setting, so as to allow the necessary time for manipulation. Glue also tends to harden the work when set. This mixture is useful when setting plain surfaces, but owing to its slow setting, it is impracticable to use it for casting purposes. This may be remedied by adding sulphate of zinc to the plaster and glue, which neutralises the slow setting and gives greater hardness to the work when set. The proportions are from 3 to 5 lbs. of glue and $1\frac{1}{2}$ lbs. of sulphate of zinc to each 100 lbs. of plaster. The glue and sulphate of zinc are dissolved in water, and the plaster subsequently added when gauging. This form of plaster may be advantageously used for casting in jelly moulds, also for fibrous plaster work.

CASTING WHITE CEMENTS.—When casting Keen's or any other white cement, or superfine plaster out of wax moulds, the casts are liable to be slightly stained, or have a yellow appearance, especially if the wax is old or soft. If pure white casts are desirable, the yellow tinge may be prevented by giving the moulds a coat of thin and clear shellac, and then oiling them with salad oil, or with fine white lard thinned with clear paraffin oil. The oil should be sparingly and evenly brushed over the mould. A ball oil-pot is excellent for this purpose.

The superfine quality of Keen's or other white cement is generally used for cast work. The cement should be gauged moderately stiff, and a part of it brushed over the surface of the mould. Another portion of cement is then laid and pressed all over with a sponge, to consolidate the stuff and extract the surplus water. As the water accumulates in the sponge, it must be squeezed out. When the surface is formed, the remainder of the cement is stiffened with dry cement and then pressed into the mould until it is full, then the surface is ruled off, keyed, and allowed to remain until set, after which the mould is immersed in water for a few minutes, and then the cast is extracted. Plaster, sulphur, and Spence's metal are sometimes used for making moulds for casting white cements. They produce sharp and white casts.

CASTING PORTLAND CEMENT.—Portland cement casts for decorative work are produced by two processes. The first and most generally known is the "wet process"; the second is of recent date, and is termed the "dry process." After a careful study of the nature of Portland cement and

aggregates, and their proper gauging, also the seasoning and oiling of the moulds, the casting of clean and sharp work will be easier and more accurate. Portland cement castings are sometimes strong, but disfigured with small surface cracks, generally termed "fire cracks." This term is wrong, as they are really water cracks, and are caused by the materials being gauged too soft or sloppy, through using more water than is actually required for gauging, and also by the moulds not having been properly seasoned, or not being watertight. The excess water, attracted by the unequal or excessive suction of the mould, collects in small rivulets and percolates through the weak and porous parts in the mould, leaving minute fissures or marks somewhat like a spider's broken web or a fine line map. Hence the necessity of well-seasoned and watertight moulds, and firm and uniform gauging. Excessive suction is sometimes caused by the plaster case of piece moulds. This may be prevented by plunging the case into water until fully charged with moisture, also by brushing the backs of the plaster pieces with water. The outward application of water prevents the porous nature of plaster absorbing the water or liquid cement from the cast.

The best and cleanest casts of small enrichments are obtained by using neat cement. The cement for the surface coat on the moulds should be sifted through a fine hair sieve or a muslin bag. Fine ground cement sets quicker and makes sharper casts than a coarse ground cement. Cast work from gelatine moulds should also be composed of neat cement. Rough or sharp aggregates cut and destroy the mould's surface. Sand being plentiful, and obtainable in most districts, is the most general in use. For cast work it should be sharp and well washed. Granite, slag, stone, or brick, broken small and free from dust, make good aggregates for cement casts. They are used in the proportion of 1 part of Portland cement to 2 of aggregate. The moulds, after being seasoned, are first oiled and then brushed over with "slip" (neat cement), and then the gauged concrete is laid and pressed into the angles with a stiff brush, and formed to the required thickness with a gauging trowel. Large casts should be made hollow, to save materials and weight, and to afford a key or fixing bond. The angles and insides of deep hollow casts are strengthened by bedding broken bricks, tiles, slates, or bits of old concrete into the gauged stuff before it is set. Large casts are also strengthened by forming partitions in the hollow interiors with any of the above lump aggregates. Casts intended for constructive purposes should be made solid, the centres being made up with a rough concrete of broken bricks, or other similar cheap material.

All cast work when taken out of the moulds should be stopped and cleaned up at once, and air-dried for a day, then kept in water for not less than three days. This not only hardens the casts, but exposes any weak spots or blemishes, and enables any defects of any kind to be made good before they leave the shop. Casts after being taken out of the water should be exposed to the air from one to three days, according to the state of the atmosphere, and, if discoloured, the surfaces should be brushed or washed with a thin solution of neat, or coloured Portland cement. If the casts are coloured, the wash is tinted with the same colours as used for gauging. The washing must be done before the surface is dry, or it will rub off. Casts that are chipped or blubby on the surface should be made good and stopped as soon as taken out of the mould.

When casting out of a gelatine mould, a fine gloss can be obtained on Portland cement casts by brushing the face of the mould with a solution of common brown sugar dissolved in water. If the gelatine is old, apply the solution slightly warm.

WATER-SEASONED PLASTER MOULDS.—Seasoning plaster moulds with water as a substitute for oil or other similar materials is a method that I have introduced and successfully used for obtaining a limited number of Portland cement casts. Temporary seasoning of plaster moulds with water is cheaper and more expeditious than permanently seasoning with oil, and it may safely

be employed when time is brief and only a few casts are required. The mould, as soon as made, is charged with water to correct the suction of the plaster and prevent adhesion of the cast to the mould. The mould is placed in a vessel containing water, until it is nearly level with the top mould rim, taking care to prevent the water getting inside. When the mould is fully charged, take it out and wipe off any surface moisture, and then brush it with paraffin oil or soap solution, and fill it in at once. The process of water-seasoning is required for every cast. If the materials are properly gauged and laid in the mould, the cast will readily leave the mould clean, and the cast will be sound and free from water cracks.

CASTING CEMENT MOULDINGS (WASTE MOULD PROCESS).—Gothic mouldings, or models of circular mouldings, having deep and narrow undercut sections or parts, cannot always be cast in plaster piece mould; and if gelatine is used, it is difficult to keep the long and narrow projecting parts of the jelly mould in a true position. The cost of jelly or plaster piece moulding is in many instances too great an item to prove remunerative, especially if a few casts only are required. Running undercut mouldings in Portland cement or white cements for planting purposes is a slow process. If the mouldings were run in long pieces and cut to the required lengths (as done for ordinary plaster), the overhanging parts of the moulding would require considerable care and nursing to form up and finish with Portland cement, thus causing the work to be tedious and expensive. In order to avoid these difficulties and decrease the expense, I have introduced the following method, called the "waste mould process," which is as follows:—Run work is not so close in texture, is more liable to laminate or flake, and is not so strong as cast work. A mould, or any fence which repels the expansion of the cement, helps to compress and strengthen the work. The cement can also be used stiffer and more firmly pressed and consolidated in a mould surrounded on all sides, than if laid on an open bracket or core. The greater amount of working on the materials by the trowel and running mould also tends to weaken the setting and hardening powers of the cement. Portland cement mouldings having deep undercut parts are best produced by using a run waste mould for each cast. This is effected by cutting a reverse running mould, and with it run a casting mould. When practicable, a fixed core should be made, so as to form the upper or finishing coat (which is the waste mould) as thin as possible, taking care that it will draw and leave the core freely when taken off with the cast. The less plaster in the mould, the less chipping will be required when freeing the cast from the plaster. Season the mould with water, as already described, and fill it in, and when set the combined mould and cast is taken off the core and placed in water for one or two days, which hardens the cast and softens the plaster. It is then taken out, and the cast freed from the plaster with the aid of a mallet and chisel. The core will serve for a number of waste moulds. This process of running waste moulds is useful, and will suggest itself for a variety of purposes.

PRESSED CEMENT WORK.—Portland cement cast work produced by the dry process is termed "pressed work." This is a method which I introduced thirty years ago, and extensively used on the Redcliffe Estate, West Brompton, London. It is clean and expeditious, and the work has a close resemblance to the grain of natural stone. It is well adapted for casts that have large or flat surfaces, such as pier caps, coping, blocks, quoins, dentils, &c. The plaster piece moulds are coated with shellac, and kept as dry as possible; they are never oiled, but simply dusted with a fine muslin bag containing French chalk. The gauge is usually 1 part of Portland cement and 2 parts of washed sharp sand, fine granite, slag, or stone, that will pass through a sieve having a $\frac{1}{16}$ -inch mesh. No more stuff should be gauged than will fill in one large mould, or one small mould two or three times, or as much as can be used in one hour. It is better to gauge often, and

in small quantities, than in large quantities, especially if using a small mould. If a large mould is being used, as much materials as will fill it should be gauged at one time. The mixing and gauging is best done on a bench or a raised board, and with the aid of a mixing rule. This is a piece of wood rule or a planed board about 2 feet long, 4 inches wide, and $\frac{1}{2}$ inch thick. The sand is first measured and spread on the gauge board, and then the dry cement is measured and sprinkled over the sand. The mass is then gathered into a heap in the centre of the board by the aid of the mixing rule, and cut and drawn in layers about 1 inch thick, until it is all at one side of the board. The mass is again gathered, and cut and drawn again till thoroughly mixed. It is then spread on the board in one layer from 2 to 3 inches thick, and a little water sprinkled over it. It is afterwards gathered together, and cut and drawn in flakes backwards and forwards, as when mixing, two or three times, adding a little water by sprinkling until the mass is moist like damp sand or snow. The proper consistency is tested by taking a handful and squeezing it like a ball. If it does not stick to the hand or crumble, but retains its form, it is fit for use; if it sticks to the fingers, it is too damp. It is better to use little water at first, and to add more if the gauge is too dry, than to use too much at first and have to add dry stuff to obtain the proper consistency. A good plan is for one man to work the mass backwards and forwards with the mixing rule, while another sprinkles the water on. The water is then sprinkled more regularly, and the proper consistency better arrived at. When the gauging is finished, a portion is laid into the mould till there is a layer from 1 to 3 inches thick, according to the depth of the mould or thickness of the cast. The first layer is consolidated by beating with wooden punches and mallets. This process of adding fresh layers of stuff and beating and ramming them is continued until the cast is flush with the rims of the mould. To obtain sound work, special attention must be given to the following details. If the surface of the mould is large and flat, the first layer is consolidated by beating with a flat wooden mallet. If the mould has an ornamental surface or deep parts, the stuff is first rammed, and then beaten with a wooden rammer or punch, a mallet being used to tap the head of the punch with a series of gentle but rapid blows, the punch being moved along the surface of the loose layer.

The punches for impacting are made of pine or other soft wood, and vary in size according to the size and form of the mould. The most useful sizes for ordinary work are from 8 inches to 12 inches long, and from $\frac{1}{2}$ inch to 3 inches square. Care must be taken when ramming and beating not to break the surface of the mould. This is best prevented by having the first layer thick, and first pressing and ramming it into the angles and deep parts with a punch, and then using the mallet on the punch. When ramming or beating deep or round parts, the punch should be smaller than the parts. It should also be rounded off at the points for curved parts.

When the first layer is thoroughly consolidated, its upper surface is roughened with a pointed tool or drag to give the key for the next layer; another portion of the gauge is then laid on and beaten as before; and so on until the mould is full. The last layer is left full above the upper edge of the mould, to allow the stuff to be well beaten, so that the upper edges of the cast will be solid. When the last or upper layer is beaten, the surplus stuff is worked off with a straight-edge until the cast is flush with the mould. The centre of the cast is then scooped out until the sides and other surfaces are from 2 inches to 3 inches thick. This is done to save materials and weight, and to give a key or fixing bond. The cast should be taken out as soon as pressed, but as the stuff is not nearly set, the cast has to be supported until set to allow of its being taken out of the mould. This is done by filling up the hollow part with neat moist sand of about the same dampness as the gauged stuff. The sand must be carefully pressed into position, so as not to disturb the cast. The sand is laid and pressed until flush with

the top of the mould. The sand will prevent the cast from collapsing when the mould is being turned over to take the pieces off the cast. After the sand is pressed and ruled flush with the mould, a little fine sand is sprinkled on the upper surface of the mould and cast. A strong inflexible board or a slate is then laid on the top, and gently moved with a circular or backward and forward motion, so as to spread the fine sand, and to give an equal and solid bed for the mould and cast. The board is held firm to the mould, both are turned over together, and laid on the bench; the case and then the pieces of the mould are taken off; the seams are now pressed in with a small tool, or a small hardwood float. Great care is required not to disturb or shake the mould when turning it over, or the cast will get cracked or otherwise spoiled. Care is also required when taking off the plaster pieces so as not to break the unset cast. The plaster pieces will leave more freely if they are gently tapped with a hammer. If the mould is large and heavy, it should be laid on a board having a narrow cleat fixed at one edge to prevent the mould from slipping when being turned over. The top board for heavy casts should be perfectly rigid, as the least yielding or bending of the board will crack the unset cast. Old cistern or billiard slates are the best kind for large and heavy casts, whilst old tiles or roof slates will do for small work. Wood boards can also be used for small work. The cast after the seams are pressed is allowed to stand from half an hour to one hour, according to the state of the atmosphere. It is then gently sprinkled with water, care being taken that the water does not descend with too much force on to the green surface of the cast, or it will disturb and spoil it. After standing for another three or four hours, according to the state of the atmosphere and the setting of the cement, the cast is again watered, but this time more freely. The watering is repeated at intervals for a day or two, or until the cast is set, and sufficiently hard to be handled. It is then put in water, and left for not less than three days. A sponge or tool-brush half filled with water is useful for the first damping of small casts. The brush or sponge is held near the surface and gently squeezed, so that one drop of water will be transferred to one spot. This will at once sink and spread; another drop or two is transferred to another part, and so on till the whole surface is slightly damped. If the atmosphere is hot and dry, or the cement quick setting, the seams should be pressed in as soon as the cast is taken from the mould. If they are allowed to dry or set, they cannot be properly pressed, and will leave a mark. The first damping should also follow immediately after the seams are pressed, to prevent too rapid drying and imperfect setting. The common or garden watering-pot with a fine rose is the most ready and serviceable tool for sprinkling water when gauging, also for watering the casts, when nearly set.

Clean and hard casts are obtained by placing them as soon as made in a chamber charged with vapour or in a moist atmosphere. If hot steam is used, the setting and hardening is greatly accelerated. Pressed work does not require so many moulds as the wet process. As the cast should be taken out as soon as pressed, one mould is generally sufficient for a fair quantity of casts. In fact, one mould, if kept dry and whole, is enough for one man to produce any reasonable number of casts. Of course the number of casts that can be obtained from a mould depends upon the form of the mould; for instance, a greater number of casts can be taken from a plain mould, such as a dentil mould, than can be taken from enriched modillion moulds. Again, the number of casts obtainable depends greatly upon the man who manipulates the mould. I have seen a mould rendered useless in the production of thirty casts by unskilful working, and a mould still good after eighty, and even ninety casts, had been taken from it. This method effects a saving in the cost of making piece moulds, and as there is no time wasted or lost in waiting for the stuff to set, as in the wet process, there is a considerable total saving. E. Suitall and my brother, R. Millar—both now dead—and T. Thorne were the first exponents in this class of work, and they, after a few days'

practice, turned out clean and sharp work. Large quantities were made with great ease in a surprisingly short space of time, and as one of them said, it was like "shelling peas."

Where building stones are scarce and sand plentiful, or where sand is to be had in abundance at little or no cost, as it should be at most parts of our sea and river shores, building blocks, plain or moulded, can be produced with great strength and durability, both quickly and cheaply, by the use of hydraulic power. Mr T. Potter, in his book on "Concrete," in reference to this class of work on the Redcliffe estate, executed under the author's supervision, after a period of nearly thirty years' wear, says "the principal portion appears to be sound and perfect at the present time."

METHOD OF REDUCING OR ENLARGING IRREGULAR FIGURES.—The subjoined illustration (No. 96) elucidates a method for reducing or enlarging irregular figures by means of squares. To obtain an enlarged copy, double the size, of any design—say a cornice and modillion as shown—draw any number of squares as shown in Fig. 1, then draw the same number of squares but double

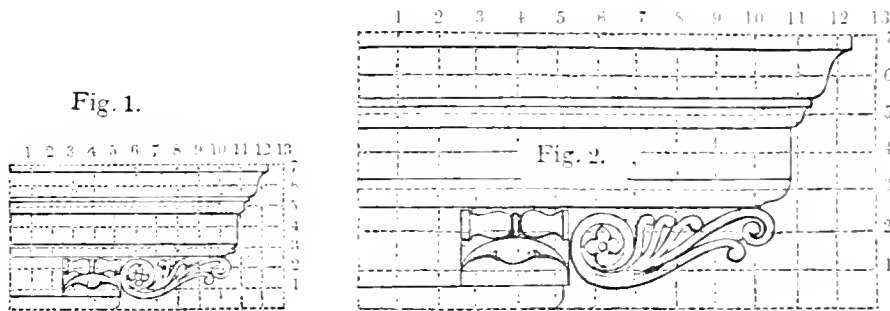

No. 96.—REDUCING OR ENLARGING IRREGULAR FIGURES.

the size on a sheet of paper and number the lines: then transfer the various points to the proper places, which will enable a fair copy, but of twice the size, to be easily drawn, as shown in Fig. 2. By the same means any desired size may be obtained. This same method is also employed for obtaining reduced sizes of the original copy. Modellers and shop-hands will find this method useful when making full-size, double the size, drawings, &c.

CHAPTER X.

MODEL AND RUNNING MOULD MAKING.

TO DRAW A TRUSS—TO MAKE A MODEL OF A TRUSS—HINGED MOULDS—DIMINISHED MODELS—TO MAKE A KEystone—TO SET OUT AND MAKE A CORINTHIAN COLUMN CAPITAL—TO MAKE A PILASTER CAPITAL—TO MODEL A CORINTHIAN CAPITAL—TO MOULD AND CAST A CORINTHIAN CAPITAL—TO MAKE COMPOSITE, DORIC, AND TUSCAN CAPITALS—TO SET OUT AND MAKE IONIC CAPITALS AND ENTABLATURE—TO DRAW THE IONIC VOLUTE—CENTRE FLOWERS—TO MAKE A CENTRE FLOWER—PRIZE CENTRE FLOWER—CAST ENRICHMENT MITRES—RUNNING MOULDS—TO MAKE A RUNNING MOULD—RUNNING MOULDS FOR ENRICHED CORNICES—TWIN SCIPPERED MOULD—RADIUS MOULD—ARCH RADIUS MOULD—HANGING MOULD—RUNNING MOULD FOR SPLAYED ANGLES—MUFFLED MOULDS—NOTES ON RUNNING MOULDS.

TO DRAW A TRUSS AND CORNICE.—To become an expert model maker the worker should acquire the power of drawing the model as well as making it. A knowledge of drawing is also essential in setting out to scale and forming full-sized or working drawings from small designs. The annexed illustration (No. 97) elucidates the method of drawing a truss and a cornice. This style of truss is generally used for the support of classical cornices placed over doors and windows. The line of pilaster, with architrave, frieze, and cornice, is also given, with the proportions figured. The architrave, frieze, and cornice (Fig. 1) is in height half the breadth of the opening, and the architrave one-sixth. The frieze and cornice being divided into seven parts, four go to the cornice (as shown above the truss) and three to the frieze, which gives the size of the upper spiral of the scroll. The longest part of the scroll (FG) takes four parts, and the lower spiral two parts. The projection of each spiral is to its height as eight to seven. The thickness of the scroll is always the same as that of the pilaster it is fixed upon, that is, two-thirds of the architrave.

The spiral is formed in the same manner as the Ionic volute, with this difference, that the Ionic volute has twelve centres, this has but eight. The centre or eye of the spiral is drawn to a larger scale (Fig. 2), with its divisions and centres marked. Begin the spiral with the first centre from 1 to 2, then from 2 to 3, and so on. The centres of the segments are found as follows:—The first is on the same line with the first centre of the upper spiral, continued to the line of pilaster at D. The lower is six parts of the smaller spiral distant from the extremity of the lesser spiral, as shown by the quadrant in the dotted lines ABC, and the lines CD, drawn from centre to centre. Join both segments in their proper lengths. The moulding in front elevation (Fig. 3), or the thickness of the scroll from EE, is divided into seven parts. One goes to each of the outer fillets, and one to the middle bead H, with its lists. Each list is one-fifth. The centre of the bead is lower than the outer fillets by one-seventh. Modillions for Corinthian cornices are set out and drawn by the same method.

TO MAKE A MODEL OF A TRUSS.—For the sake of variety a different design of a truss from the above is given to illustrate the method of making trusses, which are usually divided into three parts—viz., the "body" or main part, the "cap," and the "foot leaf." The latter in some

districts is termed a "frog leaf." The parts, with the length of each, are shown in the annexed illustration (No. 98), at Fig. 11. This gives a view of the truss to be made. C is the cap, B the body, and F the foot leaf. The whole truss is 1 foot 11 inches long. The projection of the body at the greatest part is $5\frac{1}{2}$ inches, as shown on Fig. 1. The projection of a truss is generally taken at the lowest member of the cap. In this case the example is 4 inches in projection, as shown on Fig. 10, which gives the plan of the cap. When a truss is used as a support to an arch, the lowest member of the capping moulding of the truss should not project beyond the springing of the arch, which is taken at the soffit or the intrados, or at the sides or extrados of the arch. This follows the same principle of a well-proportioned column and capital, where the line of the enrichments just above the astragal moulding is always in a line with the shaft just below the astragal. Trusses are sometimes modelled entirely in clay and in one piece. Another way is to cut the profile or sides out of a plaster slab, fix them on edge (the distance apart at the insides being equal to the width of the intended truss), and fill in the space with plaster, then run the front profile, and carve the enrichments on sides and fronts. The general way in truss-making is to cut two profiles out of a plaster slab, and fix them on edge; then run the front profile, and model the ornamental parts. There are various ways of working this process, but the following (one of my own) is expeditious and accurate:—

First make a set of thickness rules, equal in thickness to that of the outside members of the truss, and in lengths equal to the length and widths of the truss, as shown by the five A's Fig. 1. Fix the centre one on a smooth moulding board, then trace the profile of the truss on the board at each side of the rule, then fix the top, bottom, and side rules to the extreme points of the profile as shown. Make

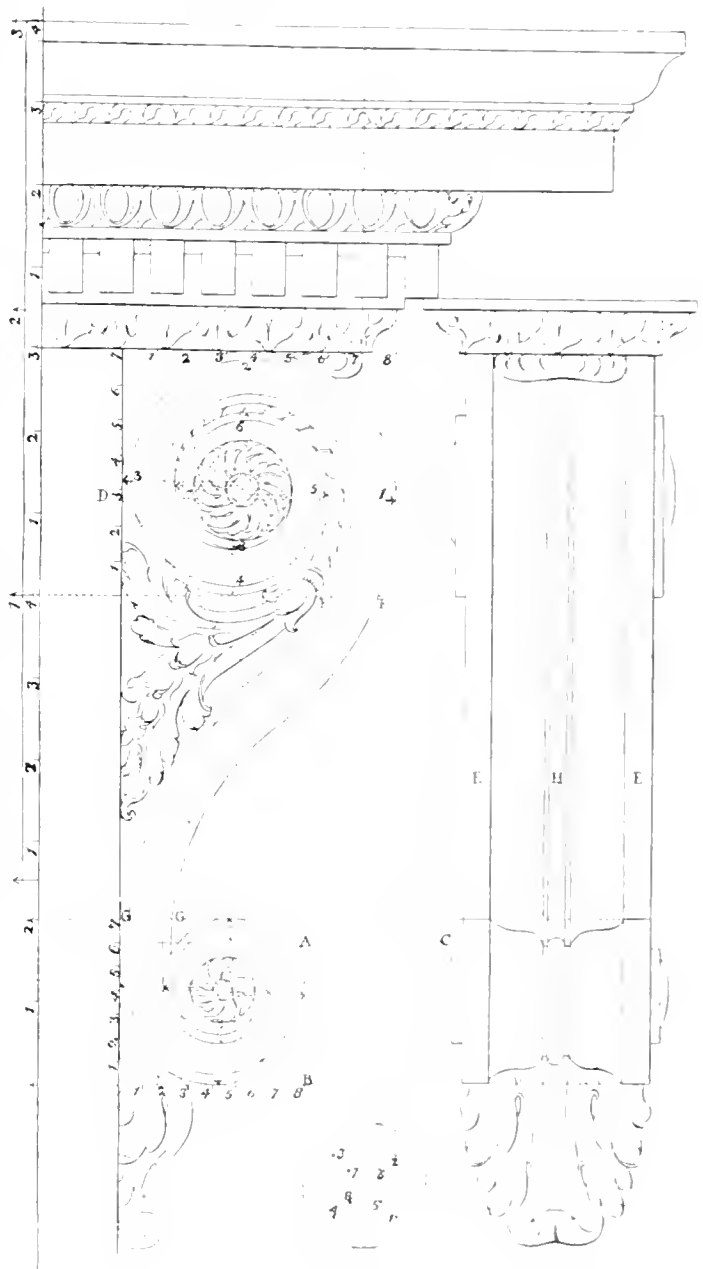
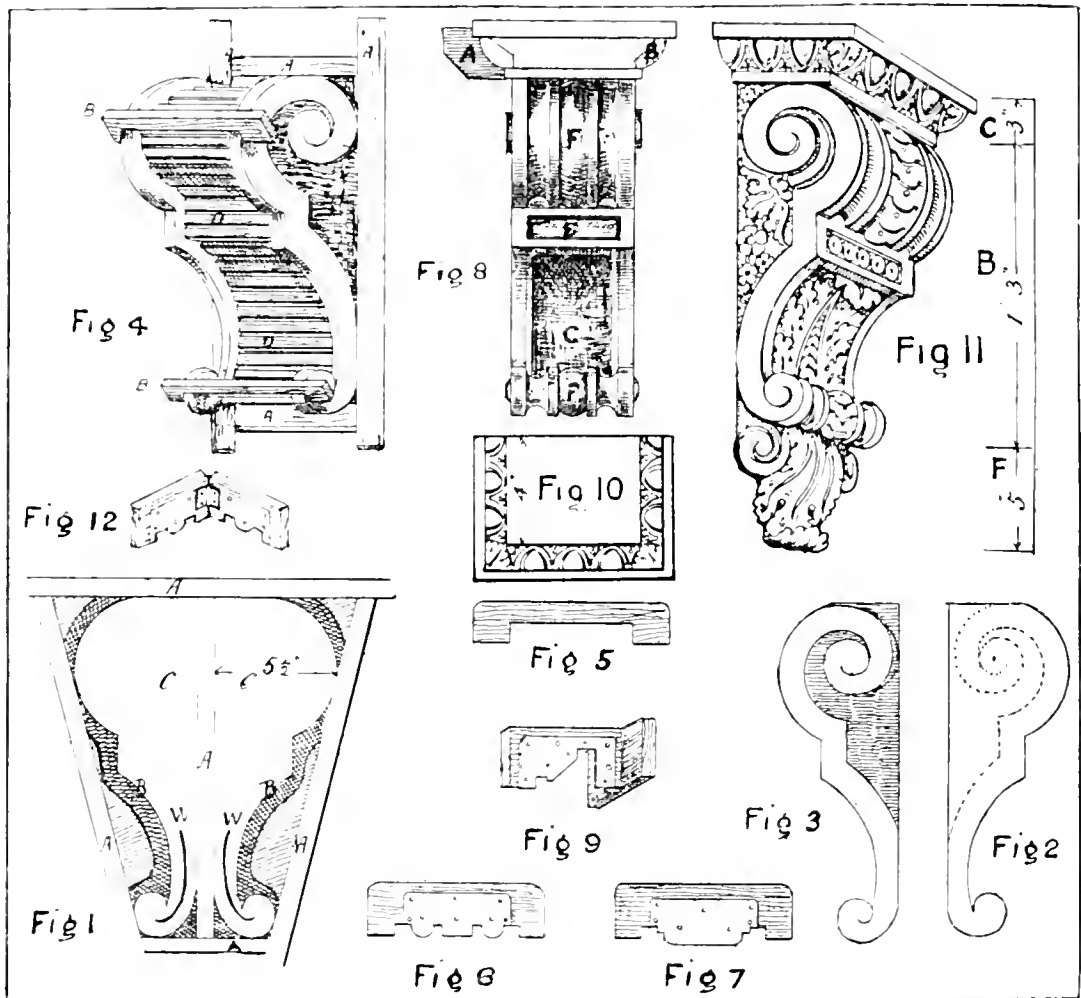

Fig. 1. Fig. 2. Fig. 3.
No. 97. — TO DRAW A TRUSS AND A CORNICE.

up the inner parts of the profile with clay strips, as shown at B. These strips are held in position with clay or plaster. This is indicated by the lighter-shaded parts of the drawing. The clay strip need not be laid to a nicety, but leaving it back from the profile rather than close to it, so as to allow about $\frac{1}{16}$ inch of plaster to cut to a true line. The thickness rules not only give the desired thickness of the sides or "cheeks" of the truss, but also (with the aid of the clay strips) form fences to keep the liquid plaster in position. By the common way the profile of the sides is traced on a plaster slab, after which the slab is cut into two pieces, and each part



NO. 98.—MAKING THE MODEL OF A TRUSS.

is again cut to the traced profile; but owing to the narrow part at the bottom scroll being very weak, these pieces are sometimes apt to get broken when cutting them to the profile. It will be seen by noting this process that the wood and clay fences not only save the plaster, but also the labour of cutting to the profile. This also allows a piece of iron or galvanised wire (W and W) to be inserted at the narrow parts above the bottom scroll, commonly called "legs." These wires strengthen the weak parts, giving more freedom when working the sides and front. Having oiled the spaces marked C and C, they are filled in with plaster. Care must be taken to insert the wires, as

shown at *w* and *w*, then rule the surface off from the thickness rules. After this, clear away the rules and clay fences, take up the sides, place them together on their ground or back edges, and against a fixed rule, to prevent these from moving while being trimmed. When trimming the outer edges to the exact profile, take care that they are true, smooth, and square. A file is an excellent tool for forming this or other circular edges. After the outer edges of the sides are trimmed, lay them flat on the moulding board, and mark the inner lines of the bands and the spirals. This is effected by pricking or pouncing from the drawing. The outer edge of the band forms the profile, and begins at the upper spiral, terminating at the lower one. These spirals are commonly called "scrolls." The inner line of the band and scrolls is indicated by the dotted line as shown on Fig. 2. The sides are next sunk, as shown on Fig. 3. If the scrolls rise or swell above the general line of band, these parts are worked up after the sides are sunk. The sides are now placed on edge, as shown on Fig. 4. They are held in position by rules (as shown by the four *A*'s), which are secured by clay or plaster dots. The sides are prevented from moving inwards by fixing wood or plaster stays from inside to inside, and from expanding by means of two or more cramps, as shown at *B* and *B*. Fig. 5 is a section of the cramp. Having fixed the sides, a foundation for the face moulding is formed by means of laths as shown at *D, D*, Fig. 4. The laths must be fixed sufficiently deep to allow for a fair thickness for the face moulding. The depth is determined by placing the running mould in position, and making a mark on each side; then from these marks form a line from end to end with the aid of a compass or a wood gauge. These lines give a guide for cutting the necessary keying, and fixing the laths. After the inner sides are well keyed and damped or shellaced, the laths are fixed with plaster, gauged with lime putty water. It may be here remarked that when fixing newly made plaster pieces together, a thin coat of shellac is an excellent substitute for water for stopping the suction. It is quicker, cleaner, and stronger than water, and is not so liable to weaken the plaster. A plaster surface overcharged with water is nearly as bad for fixing purposes as a dry surface.

After the lathing is finished, the face mouldings and the bed for the enriched parts are run. Fig. 6 shows a section of the running mould for the upper and lower parts of the truss, as shown at *F, F*, Fig. 8. The section of the running mould for forming the bed *C*, Fig. 8 for the face leaf is shown at Fig. 7. The stock is about 1 inch thick, and cut square (not splayed) at the parts that bear on the edges and outer surfaces of the sides. The metal plate is cut short at the ends, leaving just as much as will form the inner arrises. This prevents it from cutting the plaster bearings when running. Care must be taken when running face moulds that they are done quickly, and with few gauges, to prevent swelling and jumps in the mouldings. The running mould must be muffled, and the moulding blocked out with gauged plaster and putty water. This should be done in one gauge, or two at most. It is then finished with neat plaster. The mould is held at both ends, and drawn toward the worker with a steady and equal bearing. A smart workman can run the face moulding without muffling the mould by dragging the roughing out stuff down with a steel drag to counteract the swelling of the plaster, while a boy is gauging the neat plaster for finishing the moulding. The secret of success in this sort of work is to get the moulding well blocked out and run fair with the first two gauges, and then follow up with the neat plaster before the other swells. Work of this kind is generally blocked out with plaster gauged with lime putty water, and finished with neat plaster. Plaster gauged with lime putty water does not take shellac so evenly as neat plaster. The ends are made up, and the sunk panel *E*, Fig. 8 is next worked by hand, which completes the body of the truss, and it is ready for the enriched parts to be modelled. The modelling should not be begun until the cap is made, and temporarily fixed in position, so that the general effect can

be judged as a whole. The cap is made by first cutting a running mould to the proposed section, allowing for a bed for the enrichment, as shown at Fig. 9, and then a sufficient length of moulding is run and cut to the desired lengths and mitres, fixed together, as shown at Fig. 10, which shows the plan of the cap. The bed is then filled in with clay, and the profile of the enrichment run with a wood or plaster template, as shown at A, Fig. 8. The section of the run clay ready for modelling, is shown at B. The cap enrichment and body enrichments F, F, E, and C, also the side enrichments and the foot leaf, are then modelled. For large caps a length or the pattern is modelled, moulded, and the requisite number of casts made and fixed, and the mitres formed. For small work like the present example, the whole length of the enrichment and the mitres may be modelled. If only a few casts of the truss are required, they are moulded direct from the clay; but if intended for stock purposes, it is waste moulded, and then an original having a ground is cast, and then cleaned up. If a truss diminishes in width, the face moulding is run with a hinged running mould, made as follows:—

HINGED RUNNING MOULDS FOR DIMINISHED MODELS.—The use of hinges on running moulds is to allow the mould to gradually contract in width, so as to form a diminishing moulding. A running mould hinged in the centre of the profile allows both halves to close up or contract uniformly while being run up or down a diminishing space formed by two running rules or other bearings, thus forming both sides of the moulding with an equal width and uniform profile at right angles with the centre line of the moulding. Running moulds that are hinged at the sides only cannot be run at right angles with the centre line of the moulding, and when the mould assumes a raking position, it forms each half of the moulding, with a different width and profile, and as the diminish increases, the rake of the running mould gradually becomes more acute. Consequently the difference in the width and profile of each half of the moulding becomes more and more pronounced towards the end.

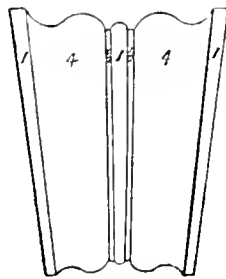

NO. 99.—KEYSTONE.

The mould plate for a hinged running mould is cut to fit the section at the widest part of the proposed moulding. After the profile has been roughly formed, cut the plate through the centre, place the halves together in a vice, and in one operation file both sides equal and true. This done, fix the half plates on separate stocks, and connect them in the centre with a hinge, as shown on illustration No. 98 Fig. 12. This shows the form of the mould when at the narrowest part of the moulding. The seam at the centre, caused by the junction of the two halves, is cleaned off by hand. If the truss was enriched, as in the foregoing example, the seam would be covered by the ornament. For small work, slippers are not necessary, but an allowance must be made for the stock to overlap the sides of the truss, and form a rebate to act as slippers. The stock must not be splayed at the bearings, but left square, so that they will run smooth and true, not cutting the plaster bearings. This form of slipper is shown at Fig. 12. Hinged running moulds for large work or special purposes are made with a slipper at each end, and in order to allow the mould to contract freely, the slippers are connected to the stock by the aid of hinges. This and other forms of hinged moulds are shown in the following illustrations.

TO MAKE A KEYSTONE.—A keystone is chosen to further elucidate the method of running the face moulding of a model that diminishes in width, as shown by illustration No. 99. The model of a keystone is made in a similar way to that described for making the model of a truss, but with the addition of using a hinged mould for the face moulding.

When cutting and horsing the plate of a running mould for the face of a diminished model,

allowance must be made for the thickness of the sides of the truss, which in this case act as bearing and running rules, the upper edges being the bearing and the sides the running rule. This is exemplified in the annexed illustration (No. 100). Fig. 1 is a view of the mould with the rebate at each side of the moulding to allow of the bearing on the edges of the sides of the model and the slippers bearing on the sides. Fig. 2 shows a plan and the position of the mould when in a diminished form at the narrow part of the model. A, A are the edges of the model sides, C, C are the hinges at the slippers and stock, and D is the hinge at the centre of the stock. It may be here remarked that for a diminished moulding (say on the flat) the mould would be more easily run if the slippers were between the running rules, as they would regulate and prevent the running mould from expanding beyond its proper width, according to the diminish, but in this case the edges of the sides of the model are part of the face moulding of model. Hence the reason for having the slippers on the outside, and bearing against the sides of the truss.

Where the moulding is wide, it is sometimes difficult to keep the slippers square when working the running mould, thus causing the halves of the moulding to be unequal in profile. This may be avoided by inserting an iron rod through the slipper, as shown at B on Figs. 1 and 2. This rod is about $\frac{1}{2}$ inch in diameter, with a round head at one end and a screw nut at the other. When the mould is in position at the widest part of the moulding the nut is screwed up tight to the slipper.

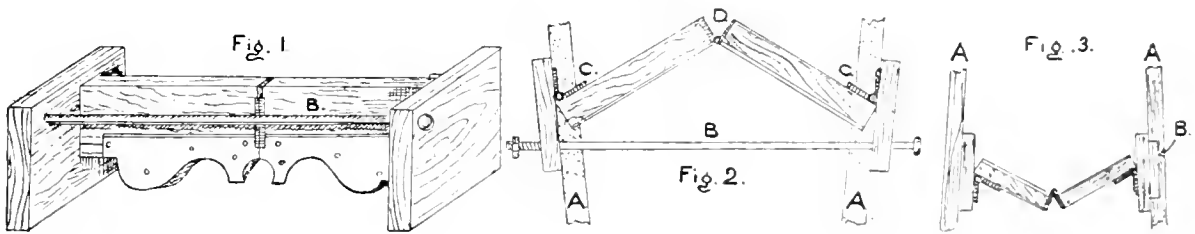

No. 100.—HINGED MOULDS.

When running the moulding, take hold of the rod in the centre with the right hand, and bear on the mould with the left hand. Then draw the running mould towards the diminished end. It will be seen that this will keep the slippers parallel with each other, thus allowing the halves of the mould to collapse regularly, and form the moulding equal in profile. The holes for the rod must be made sufficiently large to allow the rod to work freely as the mould collapses. As already stated, a hinged mould can be run more easily between running rules than if bearing on the outside. This method is shown at Fig. 3, which is the plan of a hinged mould with the slippers bearing against the running rules A, A, as used for running up a moulding on a wall or a cove. Equal-sided mouldings or column flutes which are diminished in projection or depth as well as in width are sometimes run by the aid of a rule diminished on the upper edge to give the diminish in projection, and fixed according to the required diminish in width. In this case, a fillet, as shown at B, is screwed on to each of the slippers, so as to form a rebate, and bear on the inner and upper edges. This method can only be used where the sides of the moulding butt against a stile, so as to cover the unequal depth of the two outer members or for similar purposes.

TO MAKE THE CAPITAL FOR A CORINTHIAN COLUMN.—The annexed illustration (No. 101) shows the elevation of a Corinthian capital from Palladio. There is more work in making a model of a capital (commonly called a "cap" for a Corinthian column than any other enrichment used in the plasterer's craft. After the main leaves and the volutes (one of each) are modelled, they

are waste moulded, and then each leaf is piece moulded, or the "tips" or ends of the leaves which curl over are cut off, so that they can be back and front moulded. By the former way, 16 moulding pieces are required. It usually requires 88 separate pieces (including the tips) to make one complete column, and they consist of the following:—2 halves of the vase or bell with abacus, 8 leaves and 8 tips for the first or bottom row, 8 leaves and 8 tips for second row, 4 angle volutes and 4 tips, 4 middle volutes, 8 volute leaves and 8 tips for angle part, and 8 tips for centre parts, 8 husks or springers for volute leaves and 4 pateras, and 4 stems for same. The first part of the process is to set out a full-size section and plan of the bell from the drawings. The "vase," technically termed "bell," is that part between the astragal and abacus moulding, and which forms a ground for the ornamentation. The "astragal," also known as the "necking" moulding, with about 1 inch of the shaft, is run with the bell, to serve as a guide for modelling, and for judging of the general effect of the cap as a whole while the modelling is in hand. The necking is generally cast with the bell for work that is to be afterwards painted, but for scagliola or polished work the bell is cast to the top of the necking, where the joint with the shaft cannot be so easily seen as it would be if made below it. The plan and section of the abacus is also set out, using the same scale as used for the bell. Some architects supply full-size working drawings and details, while others only give

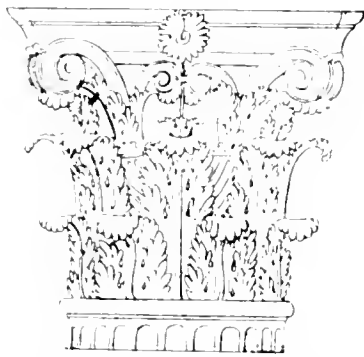

NO. 101. —CORINTHIAN CAPITAL FROM
PALLADIO.

the diameter and height of the cap at the astragal, so it behoves the plasterer and modeller to be prepared for the latter emergency, also for his own benefit and advancement to be well up in all the details of heights and projections. The annexed illustration (No. 102) elucidates the method of setting out and making a Corinthian cap. As in practice when making a cap, one-half of the plan is given, and as the same method is used for a pilaster, the plan is divided to show a quarter of each, as shown in Fig. 1. The quarter plan of the column cap is shown at A, and the pilaster at B. Each quarter shows the diameter line, and the positions of the volutes, leaves, and abacus, and the plan of the shaft with the flutes just below the necking moulding; the latter part is omitted to show the other parts more clearly. Pilasters are sometimes used insulated or in a square form; but more frequently set within a wall, and only showing a fourth or fifth of the thickness or diameter. A model of the half pilaster is usually made, so that when moulded it can be used for casting two halves to form a square, or a fourth or fifth part, as required. The smaller parts are obtained by stopping off the ends of the mould at the desired sizes. To set out the cap, first divide the given diameter of the shaft at the necking of the elevation, as shown on Fig. 2. The angles are cut off till from 5 to 8 parts wide. The length of the radius is the length between the angle points E, E; and by describing two arcs (a part of each and the radius is expressed by dotted lines which spring from the points E, E), the intersection gives the point from which the desired curve is described. It will be understood that the abacus moulding is not run as the lines shown on plan, but after the length of the radius is obtained a sufficient length of moulding is run, and then cut, mitred, laid, and fixed on the full-size plan of one-half of abacus. Fig. 2 shows a quarter elevation of the cap, volutes, leaves, and abacus, c is a section of the bell and abacus taken at the centre. The projection of the lip of the bell varies, but is usually about $7\frac{1}{2}$ parts from the finished line, not the ground line of the bell.

When setting out the face line of the bell, be sure to leave a sufficient depth to allow for a

necessary thickness for the first and second row of leaves. The face line of the first row should never project beyond the shaft line just below the astragal moulding. The thickness varies according to the size of the leaf and the desired relief. A leaf for a cap 18 inches diameter requires a greater thickness than one for a cap 12 inches diameter, so as to allow it to be safely handled while being moulded, cast, trimmed, and fixed. A $\frac{3}{4}$ inch thickness for a leaf of a cap 12 inches diameter may be taken as a standard for the necessary working strength and relief. Of course the relief can to some extent be raised or depressed by the treatment when modelling. The raised edges of the lobes, as seen in Greek foliage, appear to have a higher relief than the rounded off edges to be seen in Roman examples, even when the leaves or foliage in both are alike in thickness. In order to give greater ease and freedom when running the bell, the running mould is horsed upside down. The radius-rod should be fixed in a line with the mould plate, so that the centre plate will be in a line with the centre pin, thus obtaining a true centre. If the radius-rod is fixed at the side of the wood backing, the exact radius is not so true, nor can the mould be used for marking the upright lines when setting out the spaces for the enrichments on the bell. A wood block or centre the height of

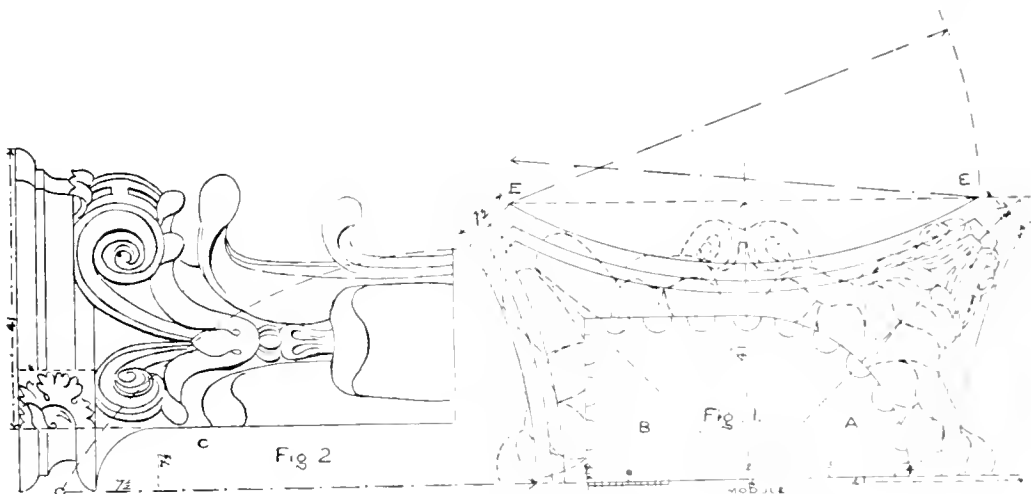

No. 102.—TO SET OUT CORINTHIAN COLUMN AND PLASTER CAPITALS.

the mould up to the radius-rod is fixed on a moulding board, cored out with old bricks or plaster, and fixed with gauged plaster, leaving a space of about $\frac{1}{2}$ inch between the core and the running mould. The core should be made about $\frac{1}{2}$ inch over the half or centre line, to give a bed for the plaster. It should be made by fixing a wood template to act as a muffle on the running mould, then covering the rough brick or plaster core with gauged plaster, and finishing with the muffled mould. Sections of the various parts used when constructing the bell are shown in the annexed illustration (No. 103). A is the centre block fixed on the moulding board; B; C is the rough plaster core; D is the plaster bell; E is the running mould; K the radius-rod; and F is the centre pin and washer. The position of the bell while the enrichments are being fixed is shown at H. It will be understood that the bell is fixed on the abacus before the enrichments are fixed, also that all the enrichments—with the exception of those that cover the joints of the two halves—are fixed in the shop before being finally fixed on the columns.

After the core is finished it is brushed over with clay water, to prevent the bell from adhering, and then two or three nails are driven at the outer sides of the centre line, to prevent the bell from

moving while it is being run. It is a good way to describe the plan of the half column on the board before the wood centre is fixed, and divide the half circle into eight parts, to be afterwards carried up and marked on the bell, and used for giving the spaces for the leaves. The radiating lines from the centre should be carried out beyond the bearing part of the slipper, to prevent all the lines being obliterated with wet plaster during the process of running the bell.

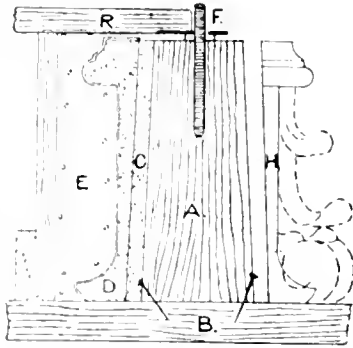

NO. 103.—SECTION OF BELL AND RUNNING MOULD FOR CORINTHIAN COLUMN CAPITAL.

Care must be taken that the centre pin is fixed exactly in the centre, or all the labour of the lines will be useless. The centre for the pin is got by placing two set squares, one at each side of the half cap line, and proving the centre on the centre block with a straight-edge bearing on the upright edges of the set squares, then reversing them to the quarter lines and trying the straight-edge as before. After the bell is run, place the running mould in position with the mould plate in a line with the lines on the board, and mark the upright lines, from the astragal down to the bottom, with a blunt knife bearing against the side of the mould plate to give a true line. After the eight lines are made, the bell is taken off the core and sawn at the centre lines. The abacus moulding is run in one length, and cut into lengths to form one full front and

two half side curves, and two short pieces for the angle mitres. The method of finding the radius and plan of abacus, with outline of bell, is shown on the illustration. When the abacus is cut and mitred, the bell is fixed on it, and the cap is now ready for the modeller.

TO MAKE A PILASTER CAPITAL.—To make a pilaster capital of the same order and size as the above, run the bell with the same mould as used for the column cap. First alter the horsing of the mould, so that it will run on the flat. Then run a sufficient length of straight moulding, and cut it into the desired lengths for the front and sides. These pieces are then placed upright on a board on which the plan of the bell has been previously set out. They are then fastened together with plaster, and the mitres made good, after which the abacus is fixed, and then the cap is ready for the modeller.

TO MODEL A CORINTHIAN CAPITAL.—The Corinthian capital is enriched with olive, parsley, laurel, or acanthus leaves. The Composite is generally enriched with acanthus leaves. The acanthus is a plant which gives great scope for fine treatment. It is a creeping, flexible plant, generally found in damp situations, but can be reared in most gardens. There are two species, one of which is prickly and jagged, something like a thistle. The other is cultivated, and has a smooth leaf. The popular name for the plant is Bear's Breech. The annexed illustration No. 104 shows the natural form of the acanthus leaf. There are a variety of ways

of treating it—the Grecian, Roman, and naturalistic, besides a great number of transitional forms. The height and projection of the leaves is best formed by cutting the profile and size of the two rows of leaves on a wood template, made to bear on the astragal and on the bell just above the leaves. When the clay is built out, draw the template over until the clay has the proper profile.



NO. 104.—NATURAL FORM OF THE ACANTHUS LEAF.

Two or three nails driven into the bell, and two into the abacus, give a good hold for the clay at the leaves and volutes. The various parts are now modelled. Only one angle and centre volute is modelled.

TO MOULD AND CAST A CORINTHIAN CAPITAL.—When the column cap is modelled, the various parts are waste moulded, casts got out, cleaned up, and then permanently moulded. The leaves are generally front and back moulded in wax. If the tips are not cut off, the whole leaf requires to be piece moulded in wax. The usual method is to waste mould the clay model, then get out a cast and clean it up, and then cut the tip off with a fine keyhole or hand saw, or with a twisted brass wire. They may also be cut in the clay if it is firm. They should be cut slightly circular (across the leaf), to give a better bed when being fixed. The joints on the leaf and tip should have a sinking about $\frac{1}{4}$ inch deep, and leaving a $\frac{1}{4}$ -inch margin round the outside of the joint. When the leaves and tips are moulded, cast, and the trimming and scratching is being done, draw the point of the knife along the sides of the sinking, and it will give an undercut, and make a good key for the fixing plaster. The tips curl and droop over, and it is important that the joint should be strong to stand the pressure of the brush when being painted or polished.

The volutes are piece moulded in wax or plaster, or a combination of both. Usually the fronts are wax and the backs plaster, or the fronts can be piece moulded in wax and the backs left open. The volute leaves are piece moulded in wax, as with the volutes. It is advisable to make a sinking when practicable on the back of all enrichments before being moulded. It saves plaster and time in forming a deep undercut. The backs of volute leaves and large angle leaves on pilasters are some-

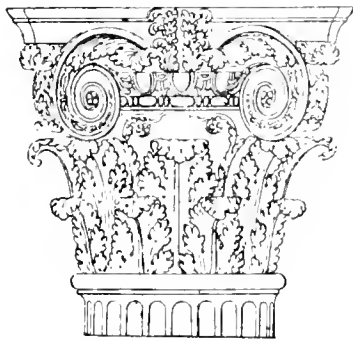

NO. 105.—COMPOSITE CAPITAL FROM THE ARCH OF TITUS.

times moulded with gelatine to save piece moulding. The leaves and other dressings are generally moulded in wax, because they can be kept as stock moulds for future use. The bell and abacus are generally fixed together, and plaster piece moulded. The lines on the bell should be left in the mould to give a guide for fixing the leaves, stems, ends of volutes, and ends of volute leaves. The fixing parts of the leaves and other dressing should be sunk (as with joints and backs of the leaves), to save time and scratching. It also gives a better key. A few small cross scratches with the knife in the centre of the sinking, and round the other parts of the bedding margin, will help to keep the leaf in position until the body of stuff in the sinking has set.

TO MAKE A COMPOSITE CAPITAL.—A beautiful example of a Composite capital is shown in illustration No. 105. In some of the Roman Composite capitals, animals, the human figure, and

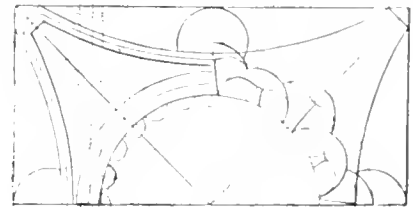
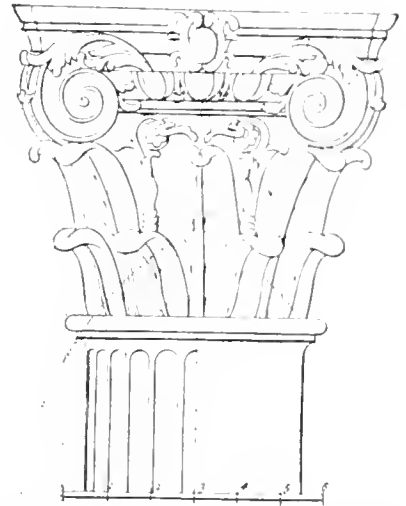

NO. 106. PLAN AND ELEVATION OF THE COMPOSITE CAPITAL.

foliage are introduced. The Composite capital is made in a similar way to the Corinthian capital. Illustration No. 106 shows the plan and elevation of the Composite capital, with the leaves outlined, and the centre from which the abacus is struck, as indicated by the intersection of the dotted lines. The plan shows the projection of the leaves and the abacus. A scale is given to assist the setting out. Only one volute is modelled. It is then waste moulded, cast, cleaned up; then piece moulded in plaster or wax, and the desired number of casts made. The face leaf on the volute is sometimes cast separate. Since the introduction of gelatine, the volute with the face leaf is moulded and cast in one piece. The small leaf that turns up from the volute towards the abacus is cast separate. The other enrichments are cast as described for Corinthian cap leaves.

Doric and Tuscan capitals are so simple in construction that if one can make full-sized working drawings of the capitals to scale, and has mastered the construction of Corinthian and Composite capitals, there should be no difficulty in making models of the Doric and Tuscan capitals.

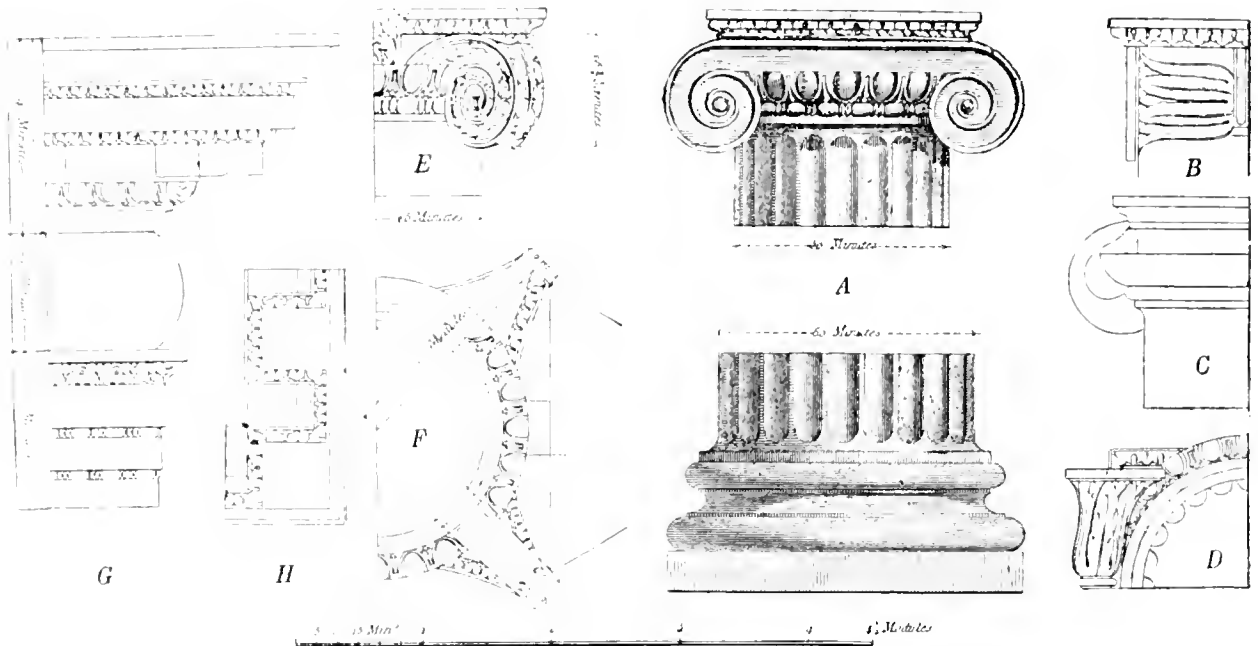

NO. 107. PLANS, ELEVATIONS, AND SECTIONS OF IONIC CAPITALS AND ENTABLATURE.

TO SET OUT IONIC CAPITALS AND ENTABLATURE.—There are several forms or designs of Ionic capitals. In some the abacus is square and plain, others are curved on all sides, and in others two faces are curved; while the flanks or baluster sides, as they are sometimes termed, are different in conformation, both vertically and horizontally. This capital is also made without a necking, according to the style. In some a swag depends from the eye of the volute. Whatever form the Ionic or voluted capital may have, the method of making it is similar to that described for the Corinthian capital. When modelling the egg and dart enrichment, care should be taken that they should be in proportion and be in a line or "principle" with the fillets and flutes of the column.

Illustration No. 107 shows the elevations, plans, and sections of Ionic capitals, columns, and entablature, with figured dimensions. Scales are given from which the various parts may be set out to any desired size. These examples will be found useful, and a ready reference when setting

out or making Ionic models for solid plaster, fibrous plaster, terra-cotta, or cement work. A is the elevation of an Ionic column, with base and capital. The abacus of this capital is square on plan. The plan of this capital is shown at D, the profile at C, and the side or end at B. The elevation of an Ionic capital, with an angular abacus, is shown at E, and the plan at F. The intersection of the diagonal lines, which spring from the angles of the abacus, gives its centre and radius. The elevation and profile of the Ionic entablature is shown at G. The frieze of this example is swelled or cushioned. The plan of the soffit is shown at H. The scale of parts, from which all the projections and heights of the order are taken, is also shown.

As some little difficulty may be experienced in setting out the volute, the following simple method is here given:—

TO DRAW THE IONIC VOLUTE.—The method of setting out and drawing the Ionic volute is elucidated by illustration No. 108. First set out the profile of the capital, and through the middle of the astragal AB draw the horizontal line EF; then from the top of the abacus draw the perpendicular line passing through the centre or eye of the volute, as GH. Within this circle are twelve centres, from 1 to 12, on which the contour of the volute is described. An enlarged sketch of the eye is given in the upper corner of the illustration. The method of setting out the twelve centres is as follows:—Divide a geometrical square, whose diagonals are one in the horizontal line, and the other on the perpendicular line, crossing each other in the centre of the eye. From the middle of the sides of this square draw two lines which divide the square into four, and each line being divided into six parts, gives the twelve centres as they are numbered in the eye of the volute. To describe the volute, open the compasses from No. 1 (in the eye of the volute) to the intersection of the perpendicular and the lower part of the abacus, and draw a quarter of a circle; continue it until it meets the horizontal line EF. Then on the point 2 place the compasses, and open them to the arch last described, and continue the arch till it meets the perpendicular line GH. Then place the compasses on the point 3, and open them to the arch last described, and continue the arch line until it meets the horizontal line EF. Then on the point 4 place the compasses, and open them to the arch last described, and continue the arch line to the perpendicular GH. Continue this process until the twelve centres or points are completed, and the contour of the volute will be described as required. The inside line or band is described by a second draft in the same manner as the former, only placing the fixed point of the compasses in twelve other centres, very near the first, viz., one-fifth part of the distance between the former, reckoning towards the centre of the eye. The twelve points in the eye of the volute are made larger than the others, on which the inside line may be described as required.

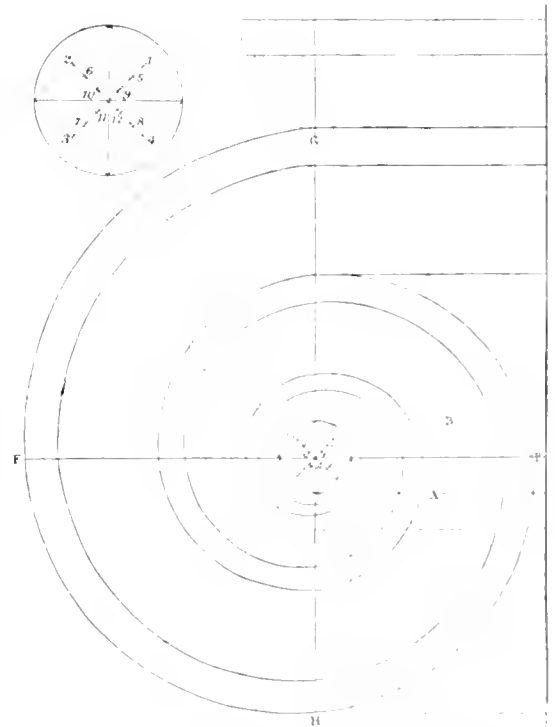

NO. 108.—TO SET OUT THE IONIC VOLUTE.

CENTRE FLOWERS.—The use of centre flowers, sometimes called roses (French, *Rosace*), for ceiling decorations has gone out of fashion during the last decade. This is partly due to the recent revival of the Queen Anne style, partly to the caprice of fashion, and partly to a more general use of panelled ceilings. Yet it is necessary that the plasterer should know how to prepare the groundwork for the modeller. Formerly "plate flowers" were greatly in use. The term "plate" was applied to these flowers because the foliage was modelled and cast on a level plaster ground. Small centre flowers were generally cast on one plate, but large flowers required several pieces to complete the design. The enriched plates were let into the ceiling and made flush with the lime plaster, so that the plate formed a part of the ceiling. This method was adopted to support the delicate foliage which was too weak to be cast separately. It was difficult to make the joints of the plate smooth and level with the lime plaster, owing in many cases to the uneven surface of the plate, caused by the plaster twisting after being cast. Owing to the difference in the nature of the materials of the laid work and the cast work, no matter how smooth and even the joints looked when newly done, they had a more or less patchy appearance when oil painted. Centre flowers having bold and deep relief were at one time largely used. These generally took the form of a circular row of large leaves and husks, placed alternately, which sprang from a centre "seed," also called a "rose" or a "drop." This generally consisted of a row of small inverted leaves surrounding a body of beads or balls, and an aperture in the centre for gas or other pipes. Centre flowers of this kind were often finished with a border or wreath of laurel, oak, or other leaves and husks. The various parts were cast separately, and fixed on the ceiling after it was set. After the centre lines for the main leaves and husk (which generally consisted of four, six, or eight of each) and the border were set out on the ceiling, the casts were held up temporarily in position, and a pencil drawn round their bedding parts to give a guide for cutting the lime plaster down to the laths, so as to give a key for the cast work. Another style of centre flowers consisted of foliage intermingled with swags of flowers, fruit, husks, &c., and some assumed such elaborate forms that from fifty to sixty casts were often required to complete a 6-foot centre flower. W. Gillies, of Edinburgh, modelled a centre flower which consisted of eighty-five parts or casts. T. Ryan, of London, designed and modelled a centre flower which required 127 pieces to complete it. J. Steel, when working in Dundee, modelled a centre flower 10 feet 6 inches in diameter, which required no less than 365 parts to complete the design. When comparing these centres of many pieces with the present-day work, it should be borne in mind that a large number of the pieces consisted of small plantings to obtain a relief in the foliage without resorting to undercutting or piece mouldings. Most of the work was cast in front and back wax mould, and the seams of the perforations trimmed off with trimming knives. These and the plate flower undercut by hand were generally gracefully designed and artistically modelled. The introduction of fibrous plaster and gelatine for the production of undercut and tender cast work, and their ready manipulation and adaptability, has decreased not only the weight, but also the labour and price of centre flowers. The decrease in price applies principally to stock patterns. The designing and modelling of new patterns constitutes a separate item. The reduction in cost brought them into more general use, and combined with the monotonous employment of stock designs, made their use so common that they soon came to be considered vulgar by one class and superfluous by others. But the extinguishing blow was dealt by the jerry-builder. This gentleman was aided by the piece-worker and the Italian plaster caster, who by their ready-made centres, generally cast in one piece, combined with their poor designing and their coarse workmanship, soon caused them to be an unsought-for decoration. This applies more to a certain class of dwellings in the

suburbs of London and a few large towns. When the centre flowers are well designed, and the work is done direct by a qualified master plasterer, without filtering through the channel of a general contractor, centre flowers are still in demand, although in lesser quantities. Centre flowers, square and octagonal on plan, are extensively used in America, but they are more appropriate for square or octagonal panels than for plain or flat ceilings. Oval centre flowers are very fashionable in France; they are certainly more suitable than round ones for long rooms, just as a round one



No. 100.—CENTRE FLOWER, PLASTER, C. J. L. N. S.

looks better than an oval in a square room. Formerly centre flowers were extensively made of carton-pierre, also in papier-mâché, but these materials are now to a great extent superseded by fibrous plaster. Cast-iron centre flowers have also been used, but owing to their great weight, general flatness, and want of relief, their use is very limited.

TO MAKE A CENTRE FLOWER.—There is a growing desire for the revival of artistic centre

flowers which points towards their more general use, not only as a centre decoration, but also as a sanitary means for ventilation. The method of making and modelling them is here given. Centre flowers are generally made with a sectional profile, which diminishes to the line of ceiling. The modelling is done on this profile or ground. To allow them to be moulded, cast, and fixed more easily, they are made in two or more parts. When setting out the ground, a bed or fixing ground should be provided for the fixing of the smaller parts on the main part. As an example of the process for making a centre flower, the design in the annexed illustration No. 109) may be taken. This is from a photograph of a centre flower modelled by the author for the Palace Club, Westminster, London, in 1875. This centre flower was originally made for circle panels, also for square panels in the same ceiling. The square was made up with spandrils consisting of medallions and sprays of laurel and oak leaves. The outer moulding and enriched border is a later addition made by John Cordingley, for general use. The diameter is about 4 feet 6 inches. Two of the four cupids and swags only are shown, so as to show the ventilating part of the centre.

The method of making this centre flower is as follows:—Illustration No. 110 is a half section of the centre flower. This also shows the various parts, which are technically termed in the trade thus: A, the “body”; C, the “centre”; D, the “drop,” or “pendant”; R, the rim moulding (this is generally taken as a part of the body); and B is the border. In order to give more facility

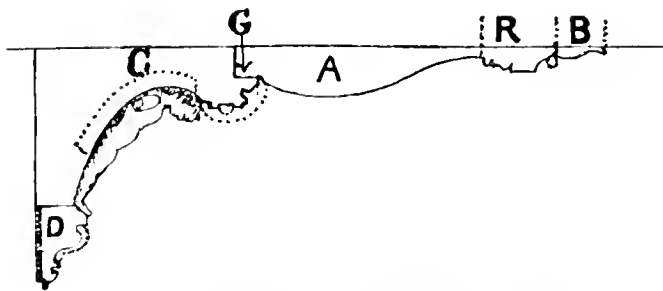

NO. 110. HALF SECTION OF CENTRE FLOWER.

for moulding and casting large or deep flowers, they are divided into four parts, viz., the body (A including R), the centre (C), the drop (D), and the border (B). This latter, if not too thin or weak, is generally moulded and cast with the body. Before cutting the running mould, a ground for the centre must be made, as shown at G, which is the bed for the centre. The dotted line on the inside of the section shows the perforation, and the dotted

lines on the outside show the profile of the clasp. It will be seen by the design that the pattern is repeated four times, therefore a quarter of the body must be run for modelling purposes. Where the pattern is repeated six or eight times to complete the circle, a sixth or an eighth part, as the case may be, is required. For some designs, especially where there is a straight leaf that runs in a line with the quarter lines, and which can be modelled for covering the joints, the run ground can be cut to the exact quarter. But in most designs it is advisable to run considerably more than the quarter of the ground to allow of judging the effects of the right and left part of the pattern. If a permanent joint was made at the straight or quarter lines of the circle, it would cut through the modelled work, and make an unsightly joint. And as it would be scarcely practicable to cut the ground to a joint that would fit the curves of the ornament, it is necessary to make a permanent joint, especially where there is not much foliage, and which requires but little making good. A permanent joint may be of any form, and is the joint at the ends of a cast which fit each other. The joint is made after the modelling is done, and the process is shown in the next sketch. A length of the border should be modelled before the joints are made. This border is modelled and cast separately.

Illustration No. 111 is a plan of the run body showing the quarter lines AB and A'B. The spaces outside these lines are the extra parts for modelling and jointing purposes. G is the bed for the centre. The quarter lines are to indicate the exact centre, and act as a guide when

modelling CD is a centre line which is simply a guide for modelling purposes. These are made before the modelling is begun, by laying the running mould upon the run body, and at the quarter marks which have previously been made on the running board, as shown by the line outside and inside the body. The marks are indented by drawing the point of a knife across the work and against the mould. The ground is then shellaced and the modelling roughed out, as shown on the sketch. The ornament in a line with the quarter line need only be modelled on one end, as shown at the left hand side of the figure. Set out a quarter of the border as shown at it, and model a length of the border. When all the modelling is finished, remove the border, and then cut the body through the quarter lines from A to B with a saw. It will be seen that this cuts through the foliage, which would make a bad joint, difficult to make good. It is therefore necessary to

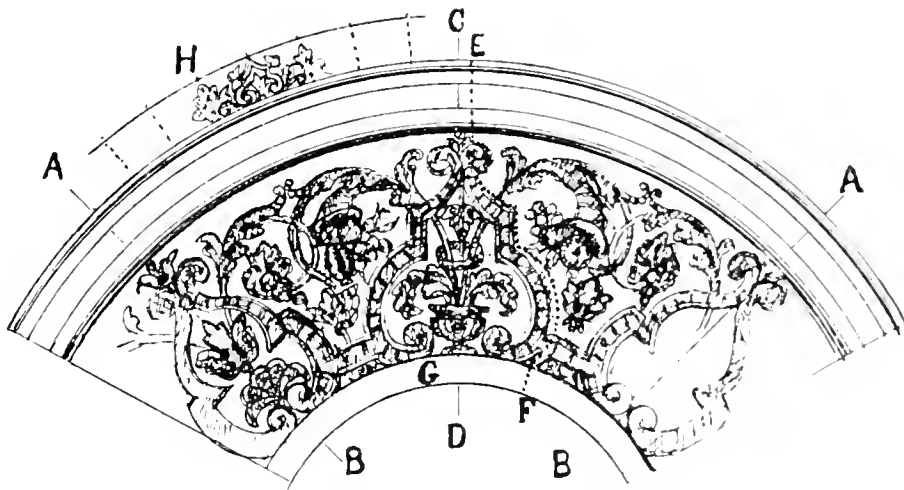

NO. 111.—PLAN OF RUN BODY AND RIM MOULDING OF CENTRE FLOWER, WITH ORNAMENT ROUGHED OUT IN THE CLAY READY, FOR JOINTING.

make a permanent joint at another part, where there is little or no foliage to cut, and where the ground will butt against the band or continued part of enrichment, where the joint will be most easily made good, and be least perceptible when fixed. This permanent joint is shown by the dotted line from F to E. This is cut with a wire or a keyhole saw, so that it will follow the curves. Care must be taken not to disturb the modelling. The wire should not be worked too close to the bands or foliage, but kept about $\frac{1}{16}$ inch away, so as to leave a small portion of the ground (next to the band) for moulding and trimming purposes. When the joints are cut, the two parts are then temporarily fixed on a moulding board, keeping the straight joints together and the curved ends outwards, thus forming a true and permanent joint, as shown on the subjoined sketch No. 112. The modelled work at the straight joint is then made good, after which the body is ready for moulding. The border in this example is moulded separately.

To obtain the finished effect of the centre flower as a whole, it is necessary to run the centre and drop parts before commencing the general modelling. During the progress of the modeling they are temporarily fixed in position on the body to allow of modelling any clasp or other connecting parts, and to judge the effect of the whole flower.

Illustration No. 113 shows a plan of the centre and the drop with a length of each enrichment roughed out in clay. When cutting the running mould for centre, a temporary bed about

$\frac{1}{4}$ inch thick must be allowed for the perforated part, also a bed for the two enrichments on the moulding, as shown on the section. The whole circle is run, and then a length of each of the enrichments modelled. The profile for each should be formed with a template. The cupids, small swags, and clasp are then modelled. They are then waste wax moulded, cleaned up, moulded again, and as many casts got out as will complete the circle. With the exception of the cupids and swags, the whole centre is then moulded in one piece. A plaster piece mould is made for the cupids, and a wax mould for the swags. The complete centre may be moulded in one piece by using gelatine. The drop is also run separately, and then the enrichment is modelled or carved. It is then piece moulded in wax, or moulded in one piece with gelatine, as desired. The body is waste moulded in wax, and an

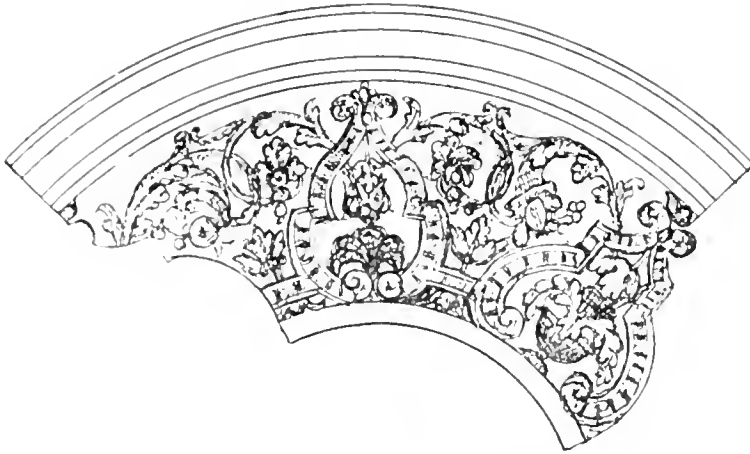

NO. 112.—PERMANENT JOINT OF THE BODY OF THE CENTRE FLOWER.

original made. If it is intended to cast the body in one piece, the waste mould can be utilised for casting the four quarters to complete the circle. They are then jointed and fixed on a moulding board, and moulded in one piece. For solid plaster the border is generally cast in short lengths, and fixed after the body is fixed; but for fibrous work, or when the border is sufficiently strong, the border may be cast with the body.

PRIZE CENTRE FLOWER.—Illustration No. 114 shows the plan and section of a centre flower designed by the author, and which obtained the first prize for a design of a centre flower, given by the *Illustrated Carpenter and Builder* in 1880. The diameter is about 8 feet 6 inches, and contains four medallions, representing the four seasons, the centre being perforated to admit of ventilation. A scale is also given. One-half of the section shows the various parts and bedding parts of the centre. A is the body, C the centre, D the drop, and B is the border. The latter includes the small point panels (W and M from which the swag of husks depend. P is a section of the pendants on the drop.

This centre flower is set out and made as described for the previous one, but with the following exceptions. In this example, the permanent joint may be made in a line with the quarter lines, which would be made through the medallions. The medallions, which are modelled, moulded, and cast on separate grounds, would cover the greater part of the joint. The point

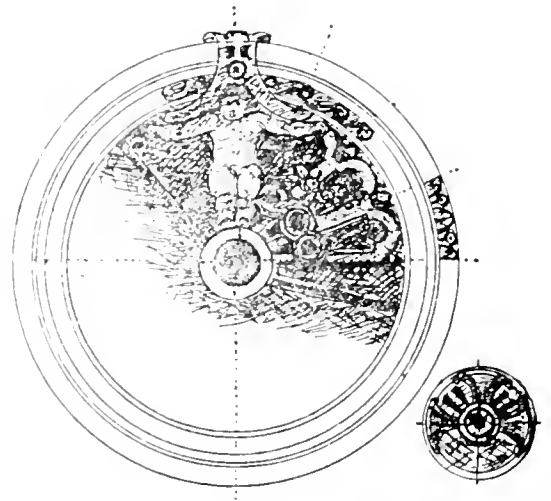

NO. 113.—CENTRE AND DROP WITH ORNAMENT
ROUGHED OUT IN THE CLAY.

panels (W, M) are cast separately, and the joints covered with the clasp patera, as shown at F on the section. The small portion of the permanent joint at the band adjoining the centre is covered with the clasp G, as shown on the section. The whole makes a clean and effective joint, which requires little or no stopping. The centres and drop in this case may be made in one piece, but it is

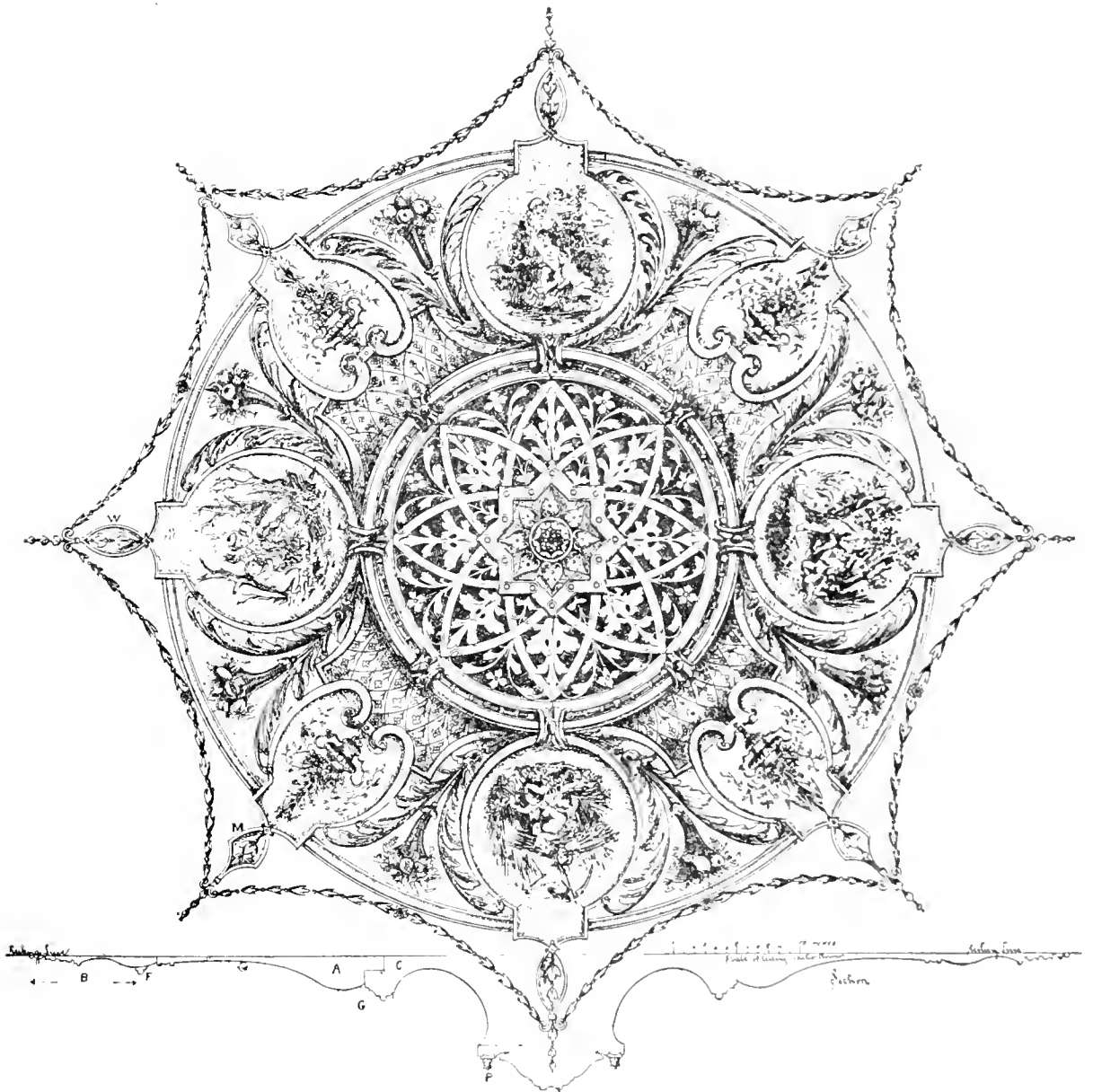

NO. 114.—PRIZE CENTRE FLOWER, PLAN AND SECTION.

advisable to cast the pendants separately, and fix them afterwards. The swag border of husks should be moulded and cast separately. The cast would be sufficiently strong (from point to point of the swag) if cast in tow and plaster. They may also be cast in paste composition, with a string through the centre to keep them together until they are fixed. Paste composition enrich-

ments can be firmly fixed on lime plaster ceilings when dry with soft compo, glue, or a soft solution of glue and plaster. Fine brads or needle points driven through the thick parts of the enrichments will further secure and also hold them in position until the fixing stuff is set.

CAST ENRICHMENT MITRES.—It has already been stated that mitres for cornice enrichments are generally modelled *in situ*. This is a good method for most kinds of enrichments, especially for large work, or if the mitres are few in number. But if the enrichments are small or have

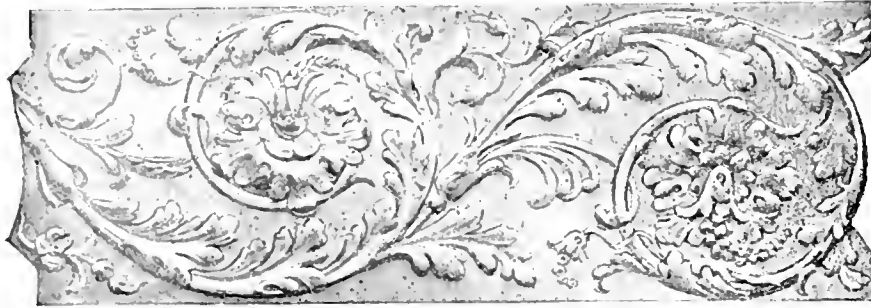

NO. 115.—SOFFIT ENRICHMENT.

repeated short patterns, such as a guilloche, or if there are numerous mitres in the work, it is more advantageous, both as regards appearance and time, to make a model of the mitre, then mould, cast, and plant it. A simple way to make a model for casting purposes is to first set out the width of the enrichment and the angle of the mitre on a moulding board, or on a plaster ground; then cut a straight cast in halves, and to the angle, taking care to preserve the main curves and lines on each half. When cut, lay the halves on the ground, and regulate the width apart at the angle, so

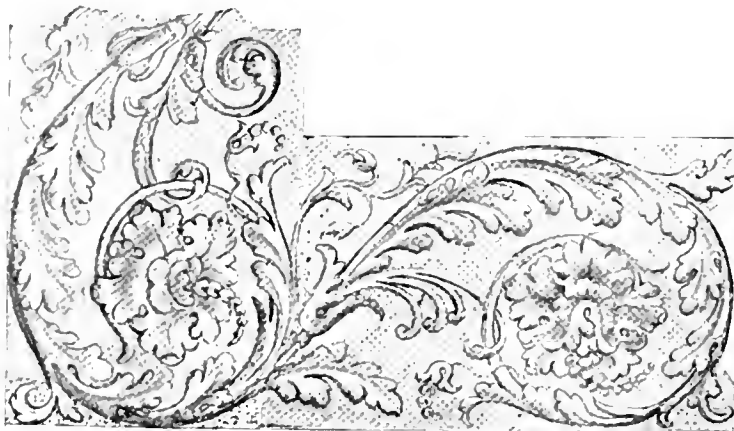

NO. 116.—INTERNAL MITRE OF SOFFIT ENRICHMENT.

as to obtain the best position to allow for a flowing curve, and one nearest to the general features of the original cast. Now fix them on the plaster ground, and fill in the joint with plaster to make up the ground of the model, and next model the parts required to join the ornament. The model is now moulded, and as many casts obtained as may be required. The accompanying illustrations will elucidate the method of making a model of a mitre, as also show mitres of various enrichments. Illustration No. 115 shows the straight cast of a soffit 9 inches wide, from which an internal right-

angle mitre is to be made. This soffit was modelled by the author for Messrs T. Cordingley & Son. Illustration No. 116 shows the mitre of the same soffit. The dotted surface indicates the made-up ground of the soffit at the joint of the two halves. It will be seen that there is only a small portion of the foliage to model in this example, as indicated by the lighter coloured parts. This method of cutting the straight cast and then modelling the foliage can be employed for making mitres *in situ* on the building. Illustration No. 117 depicts various forms of enrichment mitres. Fig. 1 shows a right-angle internal mitre of a guilloche. The model of this mitre is easily made, as the band is mostly straight. Fig. 2 shows a right-angle internal mitre of a guilloche, and Fig. 3 a splayed or acute-angle mitre for a bay window of the same enrichment. The bands of this guilloche being small and wholly circular, it would be costly to work *in situ*, especially if there was a large number, hence the reason for casting the mitres. Fig. 4 shows a right-angle internal mitre of a fret enrichment. This being composed of straight bands, it is best to work them *in situ*, unless there is a large number of mitres. For large and intricate designs, the entire model of the mitres should be

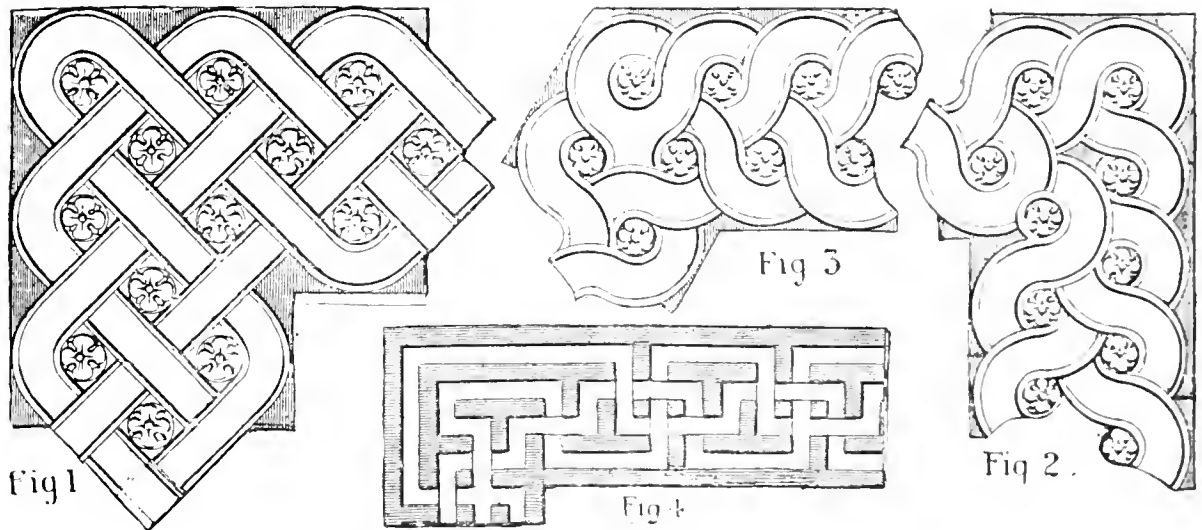

NO. 117.—CAST ENRICHMENT MITRES OF GUILLOCHE AND FRET.

modelled, instead of cutting a cast as described. Mitre lines for crown mould and bed moulds, such as eggs, &c., are modelled on a cast of the enrichment, and then moulded and cast in the usual way.

RUNNING MOULDS.—A running mould is used for forming the contour of mouldings by running it over plastic materials while soft. There are five parts in an ordinary running mould, viz., the plate, stock, slipper, wedge, and handle. The general construction or mounting the plate, so as to enable it to be run straight and square, is termed "horsing" or "horsing the mould." There are additional parts used in some running moulds, such as "splash boards" and "metal shoes." These and other parts are illustrated later on. Running moulds are sometimes made on the building; the plasterer cutting the plate, and a joiner horsing the mould. The general practice is to cut and horse the mould in the plasterer's shop. In Messrs W. Cubitt & Co.'s shop all the running mould for shop and building work was cut and horsed by a plasterer. Running moulds were formerly cut out of beech, boxwood, pear-tree, and other hard woods, also out of copper or brass, the metal plates being fixed on a wood backing. They are now cut out of sheet zinc for lime, plaster, and white cement work, sheet iron being generally used for Portland cement work.

Copper is still used for a few purposes. Galvanised sheet iron is now also used for interior and exterior work. Zinc is the best metal for most purposes. It is easily cut, and not liable to rust. Sheet zinc for running moulds may vary in thickness from a thirty-second to a sixteenth part of an inch, according to the size and requirements of the mould. The metal profile, termed the "plate," is fixed on a wood backing, termed the "stock." This is then fixed to a wood bearing called the "slipper," and supported by stays, which also form a handle. In former times the mould was run without a "slipper," a rebate being formed at the bottom of the stock to bear on and against the running rule. The mould having only this narrow and unsteady bearing may account for the undulating lines seen in some of the mouldings in very old houses.

TO MAKE A RUNNING MOULD.—In most parts of England running moulds are "horsed" to run with the right hand from right to left, while in Scotland, the North of England, and some parts of Ireland, they are horsed to run with the left hand from left to right. The latter being the most natural, is adopted here. There are various ways employed to "horse" a running mould. The following is the most simple, speedy, safe, and scientific. Illustration No. 118 shows the method of making. Fig. 1 shows a given section of an interior cornice with the ceiling and wall line. To construct a mould to run this section, first cut the plate (A). This is done by transferring the outer profile of the mouldings on to the zinc sheet from which the plate is to be cut by aid of tracing paper, or by pricking the profile on to a piece of common white wall paper. This paper

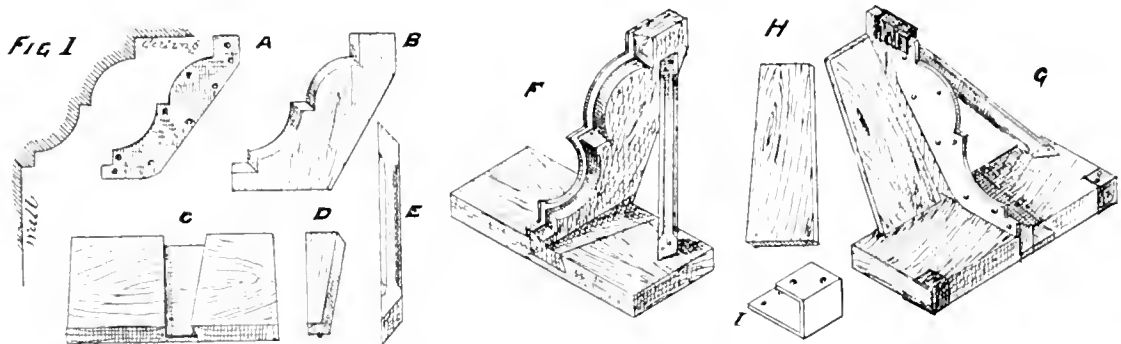

NO. 118.—TO MAKE A RUNNING MOULD.

or the tracing is then pasted on the metal sheet. The profile may also be pricked direct on to the sheet. Having marked the profile on the zinc sheet, and allowed about $1\frac{1}{2}$ inches on the ceiling and wall lines, also a sufficient width for strength, and fixing on a wood backing called the "stock," it is ready for cutting and filing. Care must be taken that the ceiling and wall lines are square with each other. The profile is then cut with a pair of snips or scissors and small beads with gouges, and afterwards filed true. After the plate is cut, place it in a vice, keeping the traced profile clear, and towards the worker, so that it can be seen while filing. This allows the plate to be easily filed to the exact profile. Zinc being of a soft nature, can be cut close to the profile; therefore little filing is required. Fine files are better than coarse ones for this work. A flat file with a safe edge is an excellent tool for forming internal angles. After the profile is cut and filed, a few holes are punched in the plate to admit of tacks or screws for fixing it on the stock, as shown on the plate (A).

Mould plates for Portland cement and similar work are generally cut out of sheet iron. After the profile is marked, the sheet is laid on a wooden block, and cut or punched with small chisels, and then filed to the true profile. After the plate is cut, the next operation is the horsing or

forming the various wood parts, and fixing them and the plate together. The wood should be planed on all faces before being cut. The first is the stock (B). This is cut out of pine wood from $\frac{1}{2}$ inch to 1 inch, according to the size of the mould. The top part, which bears on the ceiling, is called the "nib," and the bottom part, which bears on the wall, is called the "toe." The plate is laid on the wood as a guide for scribing the profile. The stock is cut a little wider than the plate to give more strength. The nib and toe are cut flush and square with the ceiling and wall lines, but the profile is cut about $\frac{1}{16}$ inch less than the true or plate profile, and from this line the edge is splayed to an angle of about 30°. This setting back of the wood stock from the plate profile, and splaying the edge, allows any coarse particles that may be in the materials used for the mouldings, and which generally accumulate at the plate profile, to sink down, and free the running edge of the plate. The splayed edge of the stock also allows the material to partly feed the mould. When running mouldings with coarse materials, such as cement and sand, the stock should be set back $\frac{1}{4}$ inch, so as to allow for a space for the coarse particles. The bottom end of the stock is cut square with the toe, allowing a depth of about $\frac{1}{2}$ inch to fit into the slipper. Where steam power is available, a band saw is a speedy tool for cutting the profiles of stocks. The slipper (C) should be squared on both sides and edges, and then a groove about $\frac{1}{2}$ inch deep cut across the centre of the upper side to receive the stock. The side of the groove next to the plate is cut square from the running edge of the slippers, and the other side is cut slantwise, so as to admit of a wedge. This holds the stock much stronger and truer than by nailing on the surface of the stock. Of course a couple of nails are also requisite to fix the stock and slipper together. The length of the slipper should not exceed twice the projection of the cornice, because if longer, the mould, in starting from the angle and finishing at the other, prevents the plate and stock from running close into the angles, thereby causing a longer length of mitre. The wedge (D) is cut to fit the groove, but less the thickness of the stock. The handle (E) is cut from a square piece of wood, and then the centre or hand part rounded off with a spokeshave, leaving about 2 inches at the ends square, which give stronger fixing points than if made round. The handle should be sufficiently long and fixed, so as to clear the mouldings, and allow plenty of room for the worker's hand. One end should be fixed near the nib to act as a stay to resist pressure and vibration while the mould is being run. Large running moulds require one or more stays to strengthen projecting or weak parts of the plate and stock, and to keep the stock upright and square. The plate is now fixed on the stock by means of tacks or screws, and then these combined parts are set into the groove of the slipper, and the wedge forced home, taking care to keep the toe of the stock flush with the face of the running edge of the slipper. Should the wedge project beyond the running edge, cut it off flush. A couple of nails or screws are then inserted from the bottom side of the slipper to further secure the stock and slipper. The nails or screws must be kept sufficiently back from the running edge as to clear the running rules. When fixing the handle, a set square should be applied upon the slipper to test the plumb of the stock. Unless the stock is square with the slipper, it is of course not upright, and therefore it will not form the moulding to the exact size and profile of the given cornice. The complete mould is shown at F. When there is a large quantity of mouldings to be run, or if the screeds are hard, it is necessary to protect the wood bearings of the running mould to better resist wear. This is effected by fixing shoes (I) on the nib and each end of the slipper. Shoes are generally made of zinc, but sometimes of leather. When using a slow-setting material, or one that has to be used in a very soft state for running off mouldings, it is advisable to use a splash-board to prevent the stuff from dropping. A splash-board (H) is about $\frac{1}{2}$ inch thick, and in length and width according to the size of the mould. The

outer edge is cut on the slant to allow the mould to be run close to the angle. It is fixed on the slipper and stock, as shown at G. This shows the complete mould with the splash-board, and the shoes on the nib and the slipper. A splash-board is also useful in preventing stuff dropping and splashing when running mouldings having a greater ceiling than wall projection.

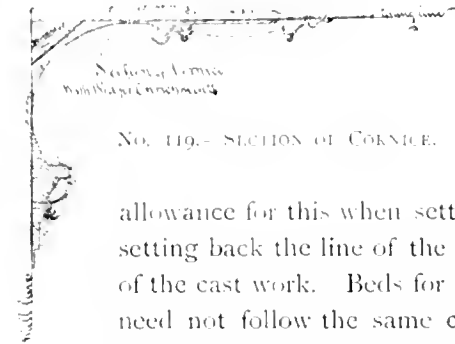

NO. 119.—SECTION OF CORNICE.

RUNNING MOULDS FOR ENRICHED CORNICES.—With regard to cutting a mould plate for an enriched cornice, a bed for the enrichments must be set out on the tracing or the profile before the plate is cut. In some designs the top enrichment fits on the line of ceiling, and in some a part of the enrichment lies on a bed and a part of the adjoining members. It is therefore necessary to make an allowance for this when setting out the mould plate. A bed for enrichments is made by setting back the line of the profile at the enriched parts, to allow for a sufficient thickness of the cast work. Beds for some forms of enrichments, such as egg-and-dart bed moulds, need not follow the same contour as the front profile, but are made with straight beds having the angles cut off, to reduce the quantity of fine plaster used for the cast work, only leaving a thickness or strength to enable the cast to be freely handled when casting and fixing. Various enrichments with their beds are shown in the annexed illustration (No. 119). This is a design of a cornice by the author which gained the first prize for a cornice design offered by the

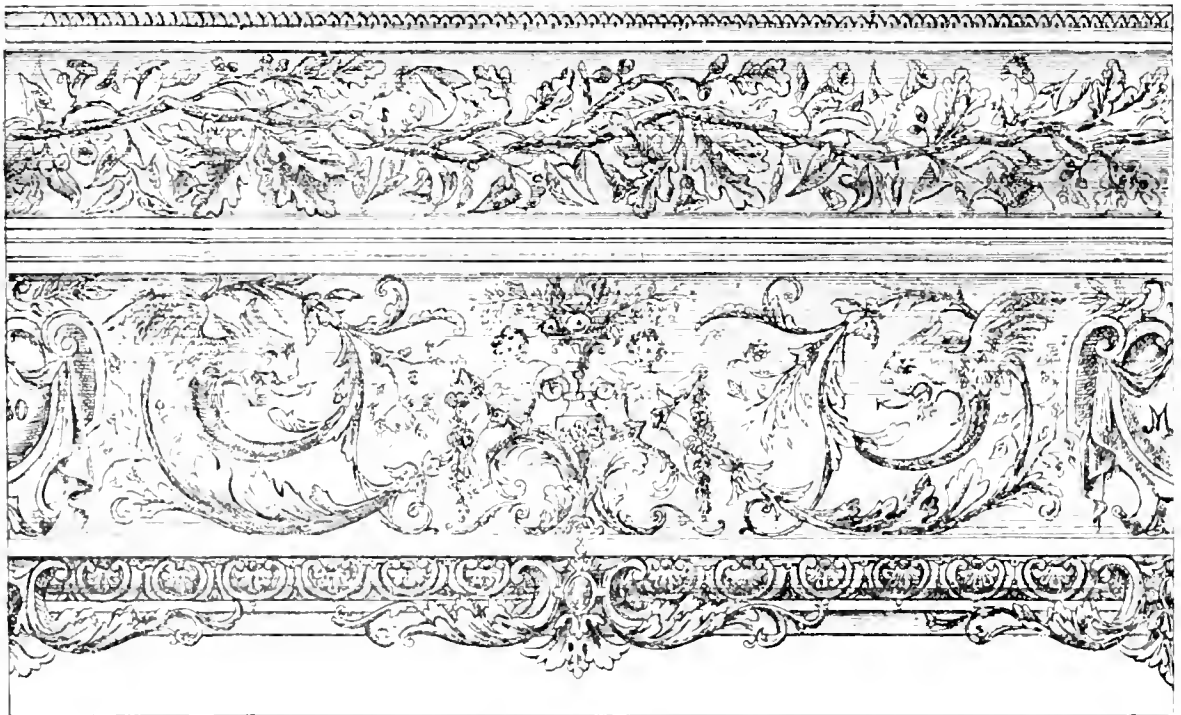

NO. 120. ELEVATION OF PRIZE CORNICE.

Carpenter and Builder, 1880. This shows the section with profile and bed of the enrichments. The dotted surface indicates the thickness of the casts; the front line is of course the profile, and the back line is the bed. The top bed mould, soffit, and cove lie between plain members, but a part of the lower bed mould lies over the cavetto and partly on the fascia members. For solid work, the

overlying part of the enrichment is cast separately, and planted after the bed mould is fixed, but for fibrous plaster work the whole enrichment can be cast in one piece. The foregoing illustration (No. 120) is an elevation of the cornice drawn to show the enrichments.

TWIN-SLIPPED MOULD.—Fig. 1 in the annexed illustration No. 121, is a perspective view of a running mould with a twin slipper. This form of mould is used where only one bearing or screed is available, such as when running a moulding adjoining old work, or a skirting moulding over a tiled plinth. The mould illustrated is for the latter purpose. The inner slipper is made shorter and thicker than the outer one. This forms a nib or bearing for the mould and a counterpoise for the outer slipper. The slippers and the stock are so arranged that there is a sufficient space between them to allow for the size of a running rule. A section of the mould is given at Fig. 2, and the running rule (R) on the plaster screed (S) is shown. The stock is let into the outer slipper in the usual way, and rebated to receive the inner slipper. Two handles are used, and are nailed to both slippers to steady the whole mould.

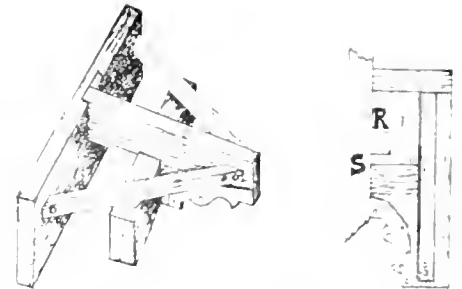
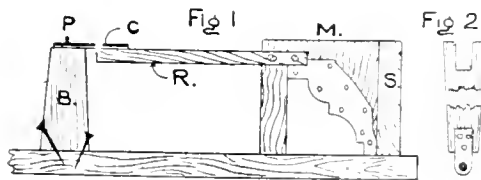

FIG. 1. FIG. 2.
No. 121.—TWIN-SLIPPED MOULD.

RADIUS MOULD.—The annexed illustration No. 122 elucidates the method of making a radius mould. This form of mould is used for running circular mouldings on a bench. A section of the mould is given at Fig. 1, which also shows sections of the various parts. B is a wooden centre block, which is fixed on a moulding board; P is the centre pin, which is let into the centre block; M is the mould; R the radius-rod; and C the centre plate. The centre plate is made with an eye to fit the centre pin, and fixed on to the radius-rod. Fig. 2 is a plan of the radius-rod showing the eye of the centre plate, also the rebate made at one end of the radius-rod to receive the stock of the mould. For small mouldings the radius-rod is fixed at the bottom of the stock. By this way no centre block is required—a centre pin or a bradawl inserted into the moulding board will be found sufficient for a centre. In some districts a radius-rod is called a "trainer," and in others a "gig-stick."



No. 122.—RADIUS MOULD.

ARCH RADIUS MOULD.—Illustration No. 123 shows sections of the various parts of an arch radius mould, as used for running the archivolt moulding and a panel moulding on the intrados of an arch in one operation. A, in Fig. 1, is a section of the arch. A part of the panel moulding on the intrados of the arch is shown. This runs parallel with the dotted line, which springs from the springing of the arch at B. A part of the mitre is shown. S is a running screed on the extrados; M is the mould; R is the radius-rod, with the centre plate; B is the radius board; P is the radius pin. Fig. 2 shows an inside elevation of the end of the radius-rod, with the centre plate. It will be seen that there is a half eye in this centre plate. This allows the mould to be more easily and quickly put on and taken off the centre pin. When the moulding does not extend below the springing line of the arch, the weight of the running mould falls on the centre pin, whereas if the moulding descends below the centre, the weight falls from the centre, therefore in the latter case a full eye is best. The eye should be made to fit the centre pin exactly. If too loose, the moulding is apt to get out of a true circle, unless held firmly against the centre pin after passing the level, or

when the weight of the mould changes. The centre plate for arch moulding should be fixed on the inside of the radius-rod, and the rod should be fixed on the mould in a line with the face of the arch, so as to get the centre correct and the moulding plumb with the wall. For this same reason, the radius board on which the centre pin is fixed should also be fixed on the same line.

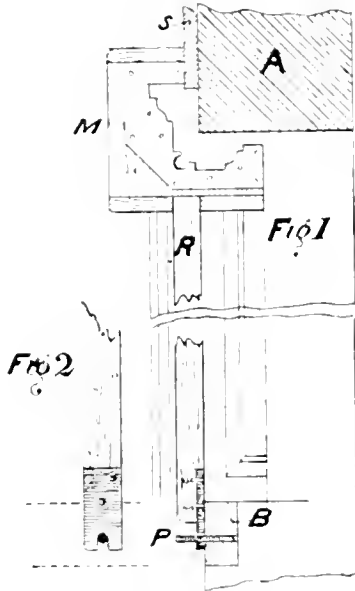

No. 123.—ARCH RADIUS MOULD.

HANGING MOULDS.—When there are no foundations for a wall rule to carry the weight of the running mould, the mould, if large, requires the application of great physical force to ensure its running steadily and true. For instance, when running a beam moulding on a cove, the mould being unsupported, it has a constant tendency to drop downwards. This may be obviated by making a "hanging mould," which is made by using two slippers on the mould. The upper or wall slipper (termed the runner slipper) is so made that it will clear the face of the running rule, and bear on the upper edge of the running rule fixed on the vertical or top screed. The lower slipper termed the nib slipper is fixed at the nib of the mould, and bears on the soffit or horizontal screed. Sections of the various parts of this mould, and a hanging mould for a crown moulding, are shown on the annexed illustration (No. 124). A, in Fig. 1, is the constructional work or wood framing; B and B are brackets; P and P are the vertical and horizontal plaster screeds; R is the running rule; and M is the running mould. Two handles are generally used (as shown) for this class of mould. Two other handles are used on the opposite sides for extra large moulds. S is the running slipper, and X is the nib slipper. The latter is generally made about half the length of the running slipper. The nib slipper allows the mould to run more easily than if run on the nib of the mould only. Fig. 2 shows a section of a main or crown cove moulding, run from a running rule fixed on the cove.

Fig. 2 illustrates the method of running a longitudinal or crown moulding over a cove. The

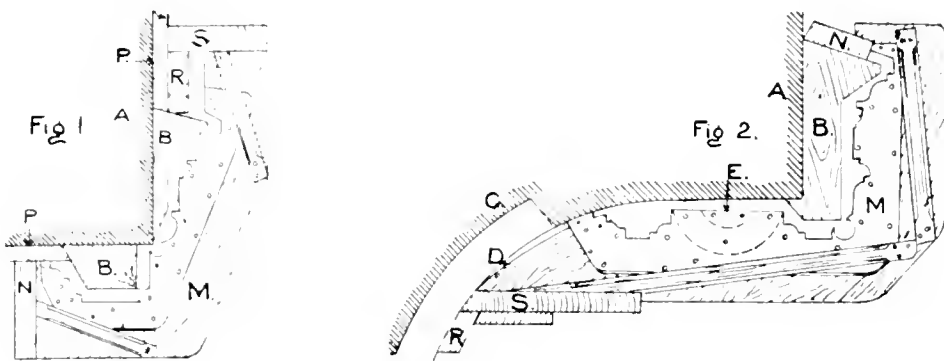

No. 124.—HANGING RUNNING MOULDS.

moulding is run from a main running rule and a nib rule. The sections of the various parts are as follows:—A is the constructional work; B the lath bracket; X the nib running rule, which is fixed on the weathering of the moulding; R is the main running rule; M is the running mould; S the slipper. Where the mouldings are extra large, they may be run in two sections. This is done by

fixing a parallel running rule on the bed of the enrichment *E*, and running a portion from each side of the rule. The dotted circular line at *I* indicates the profile of the enrichment; *C* is the back line of the sunk panel; and *D* is the face line of panel moulding.

If there are brackets for vertical mouldings in the cove which intersect with the longitudinal bracket, the upper part of the vertical ones must be cut down to allow the running mould to pass. After the longitudinal moulding is run, the vertical brackets are made good, and then the mouldings are run and mitred. Another way is to fix a running rule across the brackets (stout flooring boards are best for this purpose), so that the moulding can be run from end to end. By this method the moulding is run in two operations, the main or upper portion being first run from the running rule fixed across the brackets, and then the lower or sunk parts between the vertical mouldings are run from running rules fixed on each division of the cove. In some designs each part of the moulding may be run from a parallel rule fixed on a wide plain member, or on the ground of an enrichment, as already described.

RUNNING MOULD FOR SQUARE AND SPLOYED ANGLES.—The annexed illustration (No. 125) elucidates a simple and expeditious method of running a cornice in a room where there are square and splayed angles—between the ceiling and walls—intersecting together. By this method the same running mould with a small addition for the splayed angles is used for running a cornice in square and splayed angles, so that they will mitre true and square with each other without altering the members. This method is not only more expeditious than setting out and using a raking running mould, as generally used for splayed angles, but the mouldings on both angles being alike in size and profile, are more harmonious in appearance, and a graceful curve is conveyed to the splayed wall. The running mould is cut to the given profile, and horsed to fit the square angle in the usual way. After the square angle mouldings are run, the mould is altered so that it will run the splayed

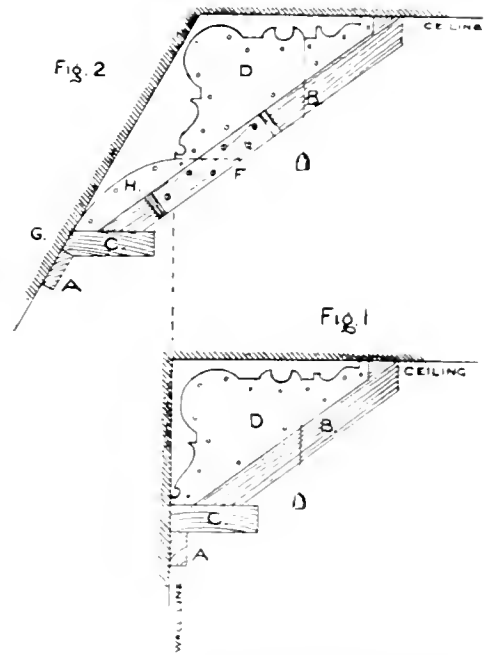

NO. 125. RUNNING MOULD FOR SQUARE AND SPLOYED ANGLES.

angle mouldings also in a square form, and to intersect with each other. The section of the running mould in position for running the square angle moulding, is shown at Fig. 1. *A* is the running rule fixed on the wall, *B* is the stock, *C* the slipper, and *D* is the plate of the running mould. The same letters apply to Fig. 2. This sketch shows a section of the running mould in position for running the splayed angle moulding. After the square angle mouldings are run, the slipper of the running mould is taken off, and then the stock is extended in length and depth until it touches the splayed wall line, and allows for a pleasing curve from the lower member of the moulding to the splayed wall. This is effected by adding an extra piece of stock and plate, cut to the desired curve, to the original stock, and fixing them together with a cleat. *H* is the added piece of stock, and *F* is the cleat. The dotted line at *F* indicates the line of the original stock. The slipper is then planed to fit the splayed wall line and the running rule *A*. In order to obtain accuracy and save time, the work should be set out on paper or a board before cutting the added stock or planing the slipper. It will be seen that about 1 inch of the square wall line is continued

below the bottom member of the moulding, as indicated by the dotted line at F. This gives a better springing for the curve than if taken from the bead. If the moulding finished with a square member, such as a fillet, the curve may spring from the arris of the member. It will be seen that by either way the curve forms part of the splayed wall. The vertical dotted line indicates the square wall line. This is used when setting out the added stock and curve. The handle of the running mould is omitted to show the other parts clearer. Both moulds must be plumbed before the running rules are fixed to ensure true intersection with each other. This is effected by the aid of a plumb-bob, as shown on both figures.

MUFFLED MOULDS.—Mouldings are roughed out with a coarse material, and finally run off or finished with a thin coat of finer material, and in order to allow a space for the finishing coat, the mould must be muffled; that is, the edge of the plate or profile must be covered so as to obtain the desired space. There are various ways of doing this. The most common is to gauge sufficient plaster, and cover the bevelled edge of the stock, allowing it to project about $\frac{1}{4}$ inch beyond the edge of the plate; and when set, this is trimmed with a knife to within about $\frac{3}{16}$ inch of the edge of the plate, following the line of profile from the ceiling line to the wall line. Another way, generally used for small work in gauged plastering, is as follows:—First rough out the moulding with gauged coarse stuff, and then fix small pieces of leather, lead, or zinc over the nib and ends of the slipper. This draws the mould out from the rough coat, and gives a space for the finishing coat. For large mouldings and the best class of work another and better method is employed. For this method an extra plate, termed a "muffling plate," is cut, the profile being cut larger, so as to project about $\frac{1}{4}$ inch beyond the profile of the true or original plate. The muffling plate is then screwed on the original plate, projecting the extra size to allow for the finishing coat. After the moulding has been roughed out, the muffling plate is taken off, and then the fine stuff is laid on and the moulding run off with the original plate.

NOTES ON RUNNING MOULDS.—Running moulds should be horsed with well-seasoned wood, otherwise the slipper is liable to swell with the wet when running the mouldings, which may throw the mould out of square. This applies specially to large moulds. All the wood-work should be planed to allow the stuff to be readily cleaned off after each gauge. Rough wood retains sand, coarse particles, or bits of set stuff, which cause furrows and rough parts in the moulding. For special work—such as running mouldings in white cements—the wood can be prevented from swelling by brushing it with paraffin oil. Zinc, or copper, is used for the mould-plate, to prevent rust, when running white cement mouldings. When running mouldings in neat plaster—such as used for reverse casting moulds—the running mould must be "horsed" stronger than for cement or lime mouldings, to enable it to resist the swelling of the plaster.

CHAPTER XI.

GELATINE MOULDING.

GELATINE: ITS USES FOR MOULDING—GELATINE MANUFACTURE, TESTS, PRESERVING, INDURATING, DISSOLVING—SEASONING GELATINE ORIGINALS—SHELLAC AND PARAFFIN SEASONING—SEAMS AND BLUES IN JELLY MOULDS—OILING JELLY MOULDS—GUM, LINSLEED, AND CHALK OILS—TO MAKE A CAST—CASES, TO SECURE AND SEPARATE—GELATINE MOULDING—TO MOULD A TRUSS—TO MOULD A BUST—BRUSHED JELLY MOULDS—COMPOUND MOULDING PIECE—MOULDING CLAY AND WHITE MODELS—OPEN AND STRAIGHT MOULDS—GLUE MOULDS—RUBBER AND SHELLAC VARNISHES—SOFT AND SPOTTY CASTS—GELATINE CASTS—INDIARUBBER MOULDS—FIBROUS PLASTER AND CONCRETE—TO MAKE A FIBROUS CASE—TO MOULD AND CAST BALCONY FRONTS—INTERCHANGEABLE MOULDS—COMBINED GELATINE AND PLASTER PIECE MOULDS.

GELATINE: ITS USES FOR MOULDING.—An operation which the operative plasterer is often greatly concerned about is the process of casting in plaster by the use of gelatine moulds. This process is looked upon something in the light of a trade secret, but it is an open secret, for technical literature has caused many to inquire into the methods, and elucidate from their friends or from some literary source the details of the process. It is not so old as might at first be imagined. It has scarcely as yet attained its jubilee, but it is a branch of the plastering art that is distinctly honoured because of its usefulness and its perfection of work. The credit of introducing gelatine for moulding purposes is claimed by Mons. H. Vincent. In 1850 he produced six casts from one mould, which at that time was considered a wonderful achievement. The date of Mons. Vincent's first attempt with gelatine moulding is uncertain, but in 1847, J. Herbert, a London modeller, produced undercut cast work from gelatine moulds. R. Foster, a plasterer's shop-hand, was the first to use gelatine in Scotland. The initial cost and trouble is more than repaid by the ready duplication of undercut work. I have seen a highly undercut soffit, 12 inches long and 6 inches wide, hung up in a casting shop in honour of its being the 125th of a series of casts out of the one mould. Even after so many had been taken out, this well deserved the place of honour, as it was a fairly clean and sharp cast. Of course the gelatine used was good—B. Young & Co.'s A1 gelatine, the oil carefully prepared, and the plaster cool. The work was done in 1871 by Messrs A. & J. Millar, of Edinburgh.

A process so artistic or rather so useful in the production of artistic work was not likely to escape the Italian moulders, who were just finding out the possibilities of their craft in the large towns of England. They soon grasped the idea, and "flexible moulds," as they termed them, were used for casting busts, statuettes, plaques, &c. The Great Exhibition of 1851, which was a revelation in the arts and crafts of many lands to English eyes, was also an opportunity for exemplifying this art by the exhibition of samples of undercut plaster work which had been cast from gelatine moulds. In the early days of gelatine for plaster casting, only the most expensive kinds were used, 4s. to 5s. per lb. being the usual price given, but these prices are prohibitory for general purposes. Gelatine which costs less than one-half the above prices, when prepared and used as hereafter

described, will last a considerable time, and yield good cast work. Before the introduction of gelatine for moulding enrichments, plaster and wax were used for moulding, plaster piece moulds being used for work on the round, and wax piece moulds for trusses and similar work. The leaves, scrolls, &c., of highly relieved work were cast separately, and then planted on the main casts. Perforated work, leaves, paterae, &c., were front and back moulded in wax; soffits and friezes were moulded in wax, and then undercut by hand. Piece moulding, front and back moulds, and undercutting by hand, are now obviated by the use of gelatine. It is now also used for moulding ordinary cast work, whether relieved or not. The originals being jointed, there is no jointing or trimming required for the casts. Gelatine moulds being much more flexible than wax, there is less force required to ease the moulds, and less broken casts. Wax moulds have the advantage that they last longer when in use, and also can be kept for an indefinite time (which is useful for stock work), whereas gelatine moulds soon dry and become hard, and require to be melted and remade if required for future use. Unless the best class of gelatine is used, and the moulds properly treated and oiled, they will not produce such clean, sharp, and true casts as wax moulds.

GELATINE MANUFACTURE.—Many plasterers have tried to make their own gelatine, but with small success. It is better and cheaper to buy it from a good maker. Gelatine is a superior kind of glue, and is obtained from bones, hoofs, hides, cartilage, and fish skins. It is extracted by means of acids, boiling and washing in lime water; it is then strained, cooled, and dried. The coarse forms of gelatine obtained from hoofs, hides, &c., are called glue; that from skins, &c., being called size. The strongest known glue is that made from the skins and sounds of fishes. The Laplanders make a very strong kind of glue from the skin of a perch, their cold climate being greatly in their favour. Here a fish skin will begin to decompose before it can be dried. They put the skins into a bladder, which takes the place of a water-bath. They are then heated until a strong elastic glue results. Common glue has great strength if it is not injured in the making by decomposition or overheating. English gelatine and Scotch glue are stronger and more elastic than the foreign made materials.

TESTS.—There are various tests for gelatine and glue. If it is not pleasant to both taste and smell, it will not be strong. Another simple test is to weigh a small piece of glue, say $\frac{1}{2}$ oz., which has been suspended in water for twenty-four hours, the temperature of the water being not above 50 Fahr. The glue swells from the absorption of water, and if it contains any colouring matter, this will sink. When the glue is taken out of the water it is weighed. The greater the increase in weight, the better the glue. If it is then perfectly dried, and weighed again, the weight of the colouring matter can be ascertained, being the difference between this and the original weight. Common glue is made from bones. Good glue is hard, clear (not necessarily light coloured, however), and free from cloudiness or flecks. Good glue will not give off an unpleasant smell after being dissolved a few days. Some of the commoner kinds are very bad in this respect, the odour from them being unbearable. Good glue, like good gelatine, will not dissolve in cold water, but will swell and assume the consistency of jelly. The quality of glue may be estimated by breaking a piece. If good, it will break hard and tough, and will be starry and irregular on the broken edge. If poor, it will break easily, and leave a smooth edge. Gelatine which is easily dissolved in cold water is not strong. The best qualities merely swell in cold water, and must be heated to the boiling point before they will thoroughly dissolve. They also absorb more water than the poorer qualities. Gelatine when dissolved is technically termed jelly. This term will hereafter be used for general purposes.

INSOLUBLE GELATINE.—Gelatine immersed in a concentrated solution of tannic acid is

rendered less sensitive to the action of water. Chrome-acid or chrome-alum renders jelly insoluble. Two parts of tannic acid added to 100 parts of dry gelatine will resist the action of water, or the mould may be immersed for a few seconds in or quickly brushed with a solution of 100 parts water and 10 parts of bichromate of potash, and then exposed to the light or sun. The compounds formed with tannic acid and with bichromate of potash are very different from each other, but neither of them can be properly remelted. The bichromated gelatine will partly retain its flexibility, and is rendered still more flexible by the addition of glycerine. Bichromated jelly is quite insoluble in water, even in hot water, and in all known solvents. It may be advantageously used in jelly moulds for casting Portland cement, or other slow-setting cements. Gelatine exposed to the action of formaldehyde in a gaseous state is rendered insoluble. A solution of paraffin wax and paraffin oil applied on the surface of jelly moulds will render them impermeable. Glue dissolved with skimmed milk in the proportion of 1 lb. of glue to 3 pints of milk will resist moisture. A glue which stands moisture without softening may be made thus: Dissolve in 8 fluid oz. of strong methylated spirit $\frac{1}{2}$ an oz. each of sandarac and mastic; add $\frac{1}{2}$ an oz. of turpentine. This solution is then added to a hot solution of glue to which isinglass has been added. Glue is rendered waterproof by adding a small percentage of caoutchouc; this is dissolved in a suitable solvent, as benzoline, naphtha, or chloroform. Glue is rendered more flexible by adding $\frac{1}{2}$ pint of spirits of wine and 1 oz. of rock candy to every 5 lbs. of glue. This admixture also preserves the glue.

PRESERVING GELATINE.—Soft jelly may be hardened by adding one per cent. of alum or half per cent. of sulphate of zinc. Nitric acid prevents jelly from souring and drying quickly. Carbolic acid added to jelly prevents it from turning mouldy or having a disagreeable smell. Linseed oil enables jelly to resist damp. Brown sugar or treacle preserves and keeps jelly moist. Jelly that has been frequently used may be improved in strength by dissolving it with stale beer, or with vinegar, instead of water. A small portion of pure beeswax renders jelly tough. Glycerine will correct jelly of its faults of drying, shrinking, and curling up. It also makes jelly tougher and more elastic. Glycerine for this purpose need not be purified. The commercial kind is quite suitable. Gelatine, whether new or in the form of old jelly moulds, should be kept in a dry place. Jelly soon begins to decompose in a damp place. The addition of a small quantity of salicylic acid or boracic acid will prolong its keeping powers. By dissolving gelatine with vinegar instead of water the resultant jelly will be rendered tougher and more elastic. Vinegar also preserves jelly.

INDURATING SOLUTIONS.—It is often necessary to indurate the surface of jelly moulds to render them impermeable to moisture and to better resist heat and the effects of continuous casting. For most purposes a saturated solution of alum will be found sufficient. A saturated solution is made by dissolving alum in water. The dissolving may be hastened by heat or slow boiling. Water overcomes the force of cohesion in certain substances, and distributes their particles throughout its own volume, the solid form becoming entirely lost, and the result is called a solution. A solution is said to be "saturated" when no more of the solid will dissolve in it. "Sugar-wash" is also used for indurating jelly surfaces. It is made by dissolving $1\frac{1}{2}$ oz. of sugar of lead (acetate of lead—this is poisonous) and 2 oz. of brown sugar to 1 quart of strong solution of alum. The whole is dissolved by gentle heat and frequent shaking. When dissolved and cool, allow the sediment to remain, pour the clear liquid into a clean bottle, and keep the bottle corked when not in use. The mould must be dusted with French chalk, and then cleanly wiped out with soft rags or a brush, to absorb any oil that may be on the face of the mould which would prevent the solution from penetrating into the surface. The mould is then thoroughly saturated with the alum solution or coated with the sugar-wash. If alum is used, the solution may be freely brushed on the mould, or

it may be poured on and allowed to lie for ten or fifteen minutes. It is then poured out, and the mould wiped clean. It is then ready for oiling. If the sugar-wash is used, it must be carefully brushed over the mould two or three times. If the jelly is soft, or the surface becomes flaccid, it may be corrected by brushing it with a weak solution of sulphate of zinc. Two oz. of linseed oil to each gallon of jelly will render it more waterproof.

DISSOLVING GELATINE.—Gelatine is dissolved by means of a water-bath. Two pots are required (the outer one for water and the inner for the jelly, like a joiner's glue-pot, only on a larger scale, and having a lip to pour the jelly freely. The primitive plan of using two pails (a small one placed inside a larger one) to dissolve jelly, is a waste of time, heat, and material. The open space between the two pails allows the steam to escape too freely, instead of confining it to melt the jelly more quickly. An old sack placed over the pail is sometimes used to confine the steam. The hot water should never be allowed to sink below the level of the jelly, as the jelly takes longer to dissolve, and it may be spoilt by burning. Scotch plasterers have a good plan for melting jelly and wax at the same time. They use an iron boiler, about 3 feet long, 2 feet 6 inches wide, and 18 inches deep, having two openings on the top to fit a jelly-pot and a wax-pot. The openings may also be used for two jelly or wax pots as required. Feed and waste pipes are connected at the top, and a hot-water tap at the bottom. These boilers can be made at most iron foundries, and are built on a brick setting, having iron bars and a door similar to an ordinary copper. They are cheap, durable, and keep the jelly and wax clean, free from burning, with always a ready supply of wax. They also supply hot water for general use, and will burn small coals. The jelly-pot should be made of block-tin. Jelly leaves the sides more freely, and is not so liable to cake as it does on iron. An ordinary sized jelly-pot is about 16 inches deep and 11 inches in diameter. A flange is fixed about 1 inch from the top to support the pot by resting on the top plate of the boiler. The flange is about 1 inch wide at the back, and increases at the front, so as to form a lip for pouring purposes. The pot should have a lid with a hole for the stirring stick. The lid keeps out dirt and retains the heat. Jelly-pots should be oiled before the jelly is put in, to allow any surplus jelly, after pouring, to be easily drawn out, and leave the pot clean. A jelly-pot is shown on illustration No. 88.

There are two ways of preparing gelatine for dissolving. The first is, to soak the dry material in clean cold water until it is soft and swollen. It is now ready for dissolving. The time required for this depends upon the quality of the gelatine. Pour off the surplus water, and keep it for thinning the jelly if too stiff, or for soaking more gelatine, or making size water. The other way is, break the gelatine cakes in small pieces, and place them in the pot and pour hot water over it, and allow it to boil until all is dissolved. The quantity of water required may vary from a half pint to one quart to each pound of gelatine, according to the quality. The first way is the best and quickest, as it dissolves more easily. This also tends to retain the strength, as excessive boiling weakens gelatine. Care must be taken that the gelatine is not over-soaked, because this weakens it, and a part of the strength is transferred to the excess water. When dissolving gelatine, it should be occasionally stirred to distribute any undissolved lumps. Gelatine should always be dissolved at as low a temperature as possible; about 100 to 120 F. will be found sufficient. The temperature for remelting jelly should not exceed 110 F. Prolonged heating or too high a temperature will cause it to speedily lose its setting and elastic powers. The pot should be taken out of the water-bath as soon as the jelly is dissolved, as excessive stirring and heat tend to lessen its toughness. After being taken out, the jelly should be once stirred and allowed to cool. If stirred again it will induce air with the jelly, and cause the mould to be "blubby," *i.e.*, full of small holes. When properly dissolved, it should be of the consistency of thin melted wax. When sufficiently cool to pour on

the original, the jelly will have a thin skin on the surface. Just before pouring the jelly, a hole must be made in this skin, close to the pouring on side or lip. Another small hole is also made at the opposite side to allow any contained air to escape, and the jelly to run freely. When the jelly-pot is emptied, this skin hangs on to the side of the pot. As it often contains frothy matter, it should be taken out and remelted for size water. Care must be taken that the jelly is not too hot when poured on, as it is liable to stick to the original. A further guide for ascertaining if too hot is to push the finger through the surface skin, and if it can be borne without discomfort, the jelly is ready for use. The right heat may also be judged by placing the hands on the outside of the jelly-pot.

As already stated, glycerine renders jelly more elastic and keeps it moist. The quantity of glycerine depends on the quality of the gelatine, and will vary from 3 oz. to 6 oz. of commercial glycerine to each pound of gelatine. The glycerine is added to the dissolved jelly just before the final stirring. When jelly moulds are done with, cut them up into small pieces, and spread them out in a dry place until wanted for remelting.

After being dissolved once or twice, a few drops of carbolic acid should be added to each pot of jelly to keep it from turning mouldy. Some large originals require a dozen or even more pails of jelly to complete the mould. In order that all the jelly may be ready at one time, a galvanized iron tank, sufficiently deep to admit good-sized pails, and pierced on the top to receive the desired number of pails, is required. This is best heated with two or more gas stoves.

SEASONING ORIGINALS FOR GELATINE.—Seasoning is a process for maturing originals and hardening plaster surfaces, also for stopping the suction to prevent adhesion, and give greater freedom in taking wax, sulphur, jelly, or plaster piece moulds from originals. An original is the model or object from which the mould is taken. Originals are also known as "solids" and "moulding pieces." Stock originals are kept for moulding purposes. Originals for wax and sulphur moulding require no special seasoning, but are simply soaked in water when required for use. Originals for jelly moulding are seasoned in various ways. The most usual is to coat the moulding surface with shellac. This is the same as patent notting. Linseed oil, paraffin wax, and French polish have been used for seasoning. Painting with shellac is a cheap, clean, and quick process. An excellent mode is to immerse the "original" in a strong solution of borax, gradually heating it. This renders the plaster almost as hard as marble, and it may be polished in like manner.

SHELLAC SEASONING.—To make shellac, get an old wide-mouthed pickle bottle. Cut a hole in the middle of the cork so that the handle of the brush will fit tight. This prevents the evaporation of the spirit which keeps the shellac in a liquid state, and the brush soft when not in use. Fill the bottle about one-third with dry orange shellac, adding wood naphtha until three parts full. Cork it slightly, and stand it in a warm place until the shellac is dissolved. This may be hastened by frequent shaking. Before using, try it on a piece of gauged plaster. If too thick, it will peel or flake. This is corrected by adding more naphtha. Two coats of thin shellac are better than one of thick. Originals should be warmed in front of a fire before the shellac is applied, to dry them. The semi-dry and warm surface gives greater cohesion. A coat of linseed oil laid before the shellac is applied hardens the surface. Shellac is useful for a variety of plastic purposes, and for general use can be applied without any oil or drying preparations. "Shellac cement" is useful for sticking together small broken pieces of originals, casts, &c. This cement is simply shellac in a thick form made by evaporation, or burning the superfluous naphtha in a tin or saucer.

OIL SEASONING.—Originals are also seasoned by coating three or four times with linseed oil

The original must be dry before the oil is applied, because the oil and the contained moisture in the original tends to rot the plaster. Linseed oil may be used for permanent originals, as it makes a hard and smooth surface; but the process is slow for general work.

PARAFFIN-WAX SEASONING.—The method of seasoning originals, also plaster piece moulds, with paraffin wax, was introduced by the author, and has given satisfactory results. The process is quick, and the originals and moulds can be used at once. It hardens the plaster, and renders the surface impervious to damp. The original is first made warm, and the dissolved paraffin applied hot. This must be done quickly and evenly or it will cake on the surface. The paraffin wax is dissolved by means of a hot-water bath, as in dissolving jelly. This is safer, cleaner, and retains the strength of the wax better than if dissolved in a pot over a fire. A little paraffin oil added to the wax makes the solution work more freely. When cold, the original can be rubbed with soft rags or cotton wool, which gives a smooth and polished surface. The finer the surface of the original, the finer will be the surface of the mould. Paraffin wax being used for several other plastic purposes, its properties are here given. It is a white, pearly, translucent substance. Though not affected by the strongest acids or alkalis, it is soluble in paraffin oil and turpentine. Its affinities are so feeble that it derives its name from this peculiarity. It has a lower melting-point than spermaceti, wax, or stearic acid. The melting-point varies from 110 to 150 F.

SEAMS AND BLUBS IN JELLY MOULDS.—Seams in jelly moulds are caused by using jelly too cold, also by insufficient space or ventilation for the jelly to run freely. These faults can be avoided by the proper manipulation of the jelly and case-making. Blubs are caused by similar errors, but principally by the force of contained air. The air is forced off, and a freer and easier passage for the jelly obtained, by pouring one or two tablespoonfuls of methylated spirits down the funnel just before pouring on the jelly in large moulds.

OILING JELLY MOULDS.—When jelly moulds were first introduced, their surfaces were painted or varnished, to enable them to resist the heat and moisture of plaster. Painting moulds makes their surfaces coarse and blunt, and having to wait for each coat to dry, makes it a slow process, and the paint being insoluble, makes the jelly coarse when remelted. A better class of gelatine was subsequently used, which by the aid of gum oils required no painting. London workmen, as a rule, are greatly behind many of their provincial brethren in the art of gelatine moulding and casting. This is partly owing to the carelessness or parsimony of some of the employers, who still insist on the use of ordinary glue and painting the moulds. Various kinds of varnishes have been employed for rendering jelly surfaces heat and damp proof; but owing to the moisture of the jelly, it is difficult to obtain a perfect cohesion of the two substances. Various gums and waxes have been used in the form of oils for protecting the face of jelly moulds. Mixtures of stearine, spermaceti, wax, and oils have been used with varying success. Canada balsam thinned down with turpentine makes a good oil. One of the best and cheapest oils for this purpose was termed "patent oil" when I first introduced it. This is now simplified in the making, and given under the name of "gum oil."

GUM OIL.—Gum oil protects the surface of the moulds, and no painting or varnishing is required. It is made as follows:—Dissolve 4 oz. of gum damar and 2 oz. of paraffin wax together by gentle heat, and then add 1½ pints of kerosene (the finest paraffin oil). When all is dissolved, pour it into a bottle, and keep it corked when not in use. Only pour out as much into an oil dish as will last a day, or better still, use a ball oil-pot. This oil is also used for oiling the original, and when the jelly is poured on it absorbs a part of the oil and renders the surface of the mould more durable and damp-proof.

CHALK OIL.—Chalk oil is also used for jelly moulds for ordinary work. It is also useful for many other shop purposes. It is made by adding steatite (French chalk), to paraffin oil until of a creamy consistency.

PETROLEUM OIL.—Crude petroleum is an excellent material for oiling jelly moulds, especially if the jelly is old, or has to stand excessive damp, such as when casting with slow-setting cements. Crude petroleum is about the best furniture or varnish renovator known. Having more body than paraffin oil, it offers a greater protection against damp to soft or weak parts in jelly moulds. Crude petroleum is prepared for commercial purposes by settling, &c. The distilled products—kerosene oil, &c.—are so valuable that oilmen do not care much to market the crude, and hence it costs as much as kerosene oil.

TO MAKE A CASE.—Plaster cases are used for keeping the various parts of wax or plaster piece moulds in position. A case for a jelly mould keeps the jelly in position, and also regulates it to a nearly uniform thickness, so that it will easily bend and allow the cast to be freely taken out. The jelly being poured through an orifice in the case, it is necessary to form a space for the jelly. The space between the original and the case regulates the thickness of the jelly. This is effected by covering the surface of the original with a coat of clay before the case is made. This clay is termed "thickness clay" because it regulates the thickness of the jelly, and is laid as follows. First cover the original with damp paper, so that the thickness clay will not adhere, dirty, or injure the face of the original. Then beat out a sufficient quantity of clay about $\frac{1}{2}$ inch thick, cut this into strips of convenient size, and lay them piece by piece on the surface until the whole of the original is covered, and nearly uniform in thickness. It will be understood that the sides, deep or undercut places of the original require an extra thickness of clay, so that it can be splayed to allow the case to draw from the clay and the jelly mould. The clay surface is then made smooth with the hands and water (not oil). A wet brush or a sponge may also be used for smoothing the surface. The smoother the clay, the smoother the case, and consequently the jelly runs freer, and the mould leaves the case more easily and cleanly when casting. After the clay is smoothed, place round and tapered clay dots on all the high points of the thickness clay. The dots are made about $\frac{1}{2}$ inch thick and about 1 inch high, or according to the thickness of the intended case. These dots form the vent holes, and also act as guides for the thickness of case. The vents allow the contained air to escape when the jelly is poured on. Another clay dot about $1\frac{1}{2}$ inches diameter is required to form an orifice for the funnel. The funnel dot should be placed at the most convenient place for pouring the jelly, but it must be at one of the lowest levels or at the ground of the original, so that the jelly while being poured in the funnel will force the air in the case up and out at the vent holes. After the clay dots are all laid and smoothed, a clay, wood, or zinc fence is fixed around the outside edge of the original to regulate the width and thickness of the rim of the case. The rim of large cases is strengthened by bedding rod or hoop iron in the plaster while making the case. Cases for large centre flowers are further strengthened by placing a hoop-iron band on the outside of the rim. This prevents chipping when turning the case over while casting. Having smoothed the thickness clay and the dots, brush the whole with soapy water, only using oil for the plaster ground of the original and plaster pieces, if any. Then pour gauged plaster over the clay, keeping the plaster flush with the dots, then make up four or more plaster dots, and float the points level with a wet board, so that when the case is turned over it will lie level on the casting bench. When the original is unequal in height, or much higher at one end than the other (as for instance a truss), the plaster dots for levelling purposes may be dispensed with, and only the highest and lowest points floated. In order to keep a mould with two unequal bearings level when

casting, the low end should be propped up with a block. For most purposes a mould with the rims level is more easily filled in than if lying in a slanting position. After the case is taken off, clean the surface, smooth and trim the vents, and stop any holes. Then shellac the inside, and a small part round the vents on the outside, which completes the case.

Funnels are made of block-tin or zinc, and in lengths from 6 inches to 2 feet. A few from 6 inches to 12 inches long will be sufficient for ordinary work. The diameter at the bottom end varies from 1 inch to $1\frac{1}{2}$ inches, and increases upwards to a diameter from 2 inches to 3 inches, according to the height. The primitive way of making and using clay and plaster funnels is insecure and a direct waste of time and materials. They may be used for small work or temporary purposes, but metal funnels are cleanest and cheapest in the end. Cases with deep sides require a rebated edge so as to form a lip to support the jelly and prevent it from dropping down in the case. The sides of long straight moulds may be kept in position by means of stiffening rules, as described later on, but for short or circular moulds with deep sides, the lip will be sufficient for the purpose. The lip is made by beating out a sheet of clay about $\frac{3}{4}$ inch thick, and then cutting strips about $\frac{3}{4}$ inch wide. The strips are quickest formed by holding a clay knife in a slanting position for the first cut, and upright for the cut at each side of the first, thus forming two strips each with a square and a splayed edge. Place the strips on edge on the ground of the original, and against the side of the thickness clay, keeping the splayed edges upwards and the acute point outwards, so as to form a corresponding splayed lip in the case. This is quicker than cutting a lip after the case is made. Sections of lips are shown in the illustration of truss moulding. Take the jelly in Figs. 1 and 2, on illustration No. 126, as thickness clay, and the formation and use of lips will be better understood.

In large originals, or where the jelly space is thin, the jelly often runs slowly, and causes crinkles or blubs on the mould's surface. This is partly due to the jelly getting cold (by travelling over a large space, and being reduced in body thickness), and partly due to the resistance of the contained air, and may be avoided by forming a series of small channels in the surface of the case, each about $\frac{1}{4}$ inch wide and $\frac{1}{4}$ inch deep, and running from vent to vent, to allow a free passage for the contained air, thus allowing the jelly to run more freely. Channels are sometimes formed after the case is made by sinking grooves with a gauge or the angle of a chisel. They are best formed when making the case by laying V-shaped strips of clay, cut to the desired size, on the thickness clay, and from vent dot to vent dot, thus forming the sunk channels in the case. Fibrous plaster cases are also used for jelly moulds. They are punctured so as to allow the air to escape, thus dispensing with vents. The method of making fibrous plaster cases is described later on.

TO SECURE CASES.—Cases must be securely fastened down, or the jelly will force the case from the ground of the original, and spoil the mould. Cases are secured by placing weights on the top, also by means of wood struts fixed between the ceiling and the case. Large work is further secured by means of a coat of plaster and canvas laid over the joint of the case and the ground of the original. All joints should be covered with plaster or clay to prevent the jelly oozing out.

JOGGLES.—Originals and cases require corresponding joggles to keep the case in position. Unless the case is always put on in one position, it will injure and chip the original. Joggles should be made on the ground of the original. This is done by scratching the parts required, and for a further key, drive a few tacks into the plaster ground, leaving them protruding. The joggles are then made up to the desired form with gauged plaster and putty water. These raised joggles form a sunk joggle on the case, and consequently are not in the way, and allow the mould to be freely ruled off. Joggles should be made as large as practicable. If small, the case is apt to slip, and they are not so strong. One of them should be made larger, or a different shape, or two should be placed nearer

each other than the others, so as to give a distinctive point, and save the original from injury. This also saves time in finding the corresponding joggles. Small originals, such as flat bed moulds, do not require joggles, but one end of the original may be cut to a different shape, or have a sunk mark. When the case is made, it fits all the sides and ends of the ground, the different cut end or mark giving a corresponding form on the case, which acts as a guide for fixing. A novel form of joggles, termed "run joggles," is described on page 388, Chapter XIII.

TO SEPARATE CASES.—Sometimes it is difficult to get the case of the mould and original apart without injuring the case or original. This is owing to various causes, the principal being insufficient seasoning. If the original is too large to be conveniently soaked before moulding, wash or cover the surface with a brush or cloth dipped in soapy water until the body suction is stopped. The case is damped in the same way, the surface of both being dried before oiling. Seasoning with oils or shellac only stops the surface suction. Pouring jelly on too hot, or irregular oiling of the case or the original, will also have the same effect, all of which, singly or combined, cause the jelly to stick to the case or the original, which makes the case difficult to separate from the mould, and the mould from the original. These difficulties can be prevented by avoiding the causes. They may be cured by immersing the original and case (with mould inside) into water for a few minutes, or until the air bubbles cease. After this, place the original solid on a bench, and insert flat wood wedges about 1 foot apart, and gently drive them home with a hammer until the case lifts. Should the mould stick to the original, plunge the whole into water as before. The water only gets at the outside of the mould. Good jelly is not injured by temporary contact with water.

GELATINE MOULDING.—Having described the preliminary parts of the process of gelatine moulding, pouring the jelly on the original now claims attention. Before describing this simple part, it will be advisable, for the sake of continuity, to summarise the parts together. After the original is seasoned, it is first dusted, and if old and dry, it must be soaked or sponged with soapy water to correct internal suction. It is then wiped to free the surface from moisture, and then carefully oiled with gum oil or chalk oil, according to the condition of the jelly. The case is prepared in a similar way, and placed on the original, taking care that it is laid on the right joggles or marks, so as not to injure the original. The case is then secured by means of weights or struts, and the joint stopped with clay or plaster. The funnel is then fixed with clay, and if large, it is further secured with plaster. Pats of clay are then laid close to each vent hole, to be ready for stopping the jelly when it rises through the vents. The jelly being dissolved and cooled to the requisite degree of heat, is then poured steadily and regularly into the funnel until the jelly rises to the highest vents. The vents are stopped with clay pats as the jelly rises. The whole is then allowed to stand until the jelly is cold or set. This may be ascertained by feeling the jelly in the funnel. When sufficiently set, the funnel is taken off by cutting the jelly at the lower extremity. The clay pats are next removed, and any projecting bits of jelly cut off. The case is then taken off, and the jelly "tits" (formed by the vents on the back surface of the mould) are cut off. This surface is then dusted to prevent the mould from adhering to the case when casting. Dusting is effected by dipping a dry brush into dry plaster and then shaking the brush over the mould, so as to sprinkle the plaster over the mould's surface. The superfluous plaster is then brushed off, leaving a dry surface. The mould is then taken off the original and placed in the case. The surface of the mould is then wiped dry with a soft brush, or soft rags or paper, and afterwards brushed with alum water or with "sugar-wash." The surface is wiped again, and then oiled with gum oil or chalk oil, according to the class of work required. It is now ready for filling in and casting.

TO JELLY MOULD A TRUSS.—Illustration No. 126 elucidates the method of jelly moulding a truss with its cap and foot leaf in one piece. Fig. 1 shows a side section of the truss, jelly, case, and a plaster piece on a moulding board. A is the truss, G the ground, D the case, B the jelly, C a plaster piece, F the funnel, and the *e*'s are vent holes. The plaster piece C is used to decrease the amount of jelly, and allow the sides of the mould to be more freely opened when casting.

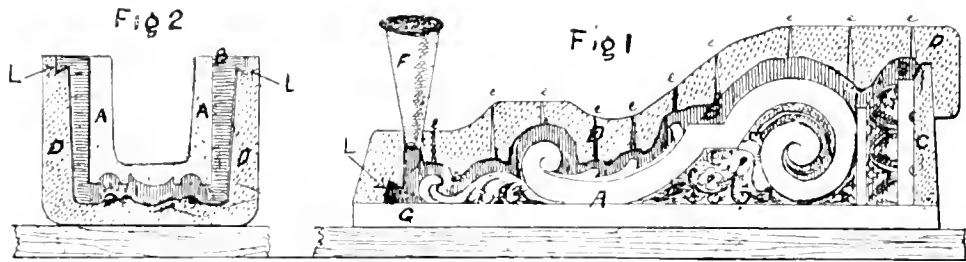

NO. 126.—MOULDING A TRUSS WITH GELATINE.

This plaster piece is generally used when there is a plain or large flat part in the original. It is made before the thickness clay for the case is laid. To make this piece, first sink two or more joggles in the top of the truss cap. A section of two is shown at *c*. The joggles keep the piece in position when making the case, and also when casting. Then lay strips of clay about $\frac{3}{4}$ inch thick on the sides and top of the cap, keeping them close to the edge, then oil the top or end of the original, and lay the plaster on, keeping it about $1\frac{1}{2}$ inches thick at the bottom, and tapering it up to the top until about 1 inch thick. The sides are tapered to the same form and thickness. The piece is then taken off and trimmed fair, taking care to splay the inner edges, so that it will draw freely. The form of the splay is shown on the top edge of the piece at *c*. This piece is made the same way as described for the end pieces, in plaster piece moulding a modillion, page 268. The piece is then coated with shellac and replaced in position, and then the thickness clay is laid, keeping it flush with the edges of the piece as shown. The case is then finished as already described. It may be here mentioned that the case need not be carried all over the end or plaster piece, but only carried over about 2 or 3 inches as shown, so as to leave an opening, which forms a hand hold for lifting the case off the mould when casting. A lip in the case—which is continued on the sides—is shown at *L*. This supports the jelly sides, and prevents them from drooping inwards. Fig. 2 shows an end section of the mould and cast; *D* is the case, *B* the jelly, *L, L* the lips, and *A* the cast.

TO MOULD A BUST.—The method of moulding a bust with gelatine is shown on Plate XLIII. Fig. 1 depicts a bust of the author, modelled in 1877, by himself, with the aid of looking-glasses. The bust and the base are moulded and cast separately, and then fixed together. Sometimes they are moulded and cast in one piece. The base should always be used when modelling a bust, as a better idea is obtained of the general effect. When the bust and the base are cast separate, the bust may be jelly moulded, and a plaster piece mould used for the base. It will be seen that this method is adopted in the present example. This method decreases the weight of the mould, gives a greater opening for filling in, and more freedom when casting. By using a plaster piece mould for the base, the moulding is generally truer than if out of a jelly mould with the bust attached. A plaster mould also gives better results if Keen's or other white cement casts are required. Fig. 2 shows a front view of the bust on a moulding board covered with the thickness clay. The dark band which extends around the bust is a clay fence, used to divide the case into two parts. The greater part is generally the face part, so as to keep the joints of the

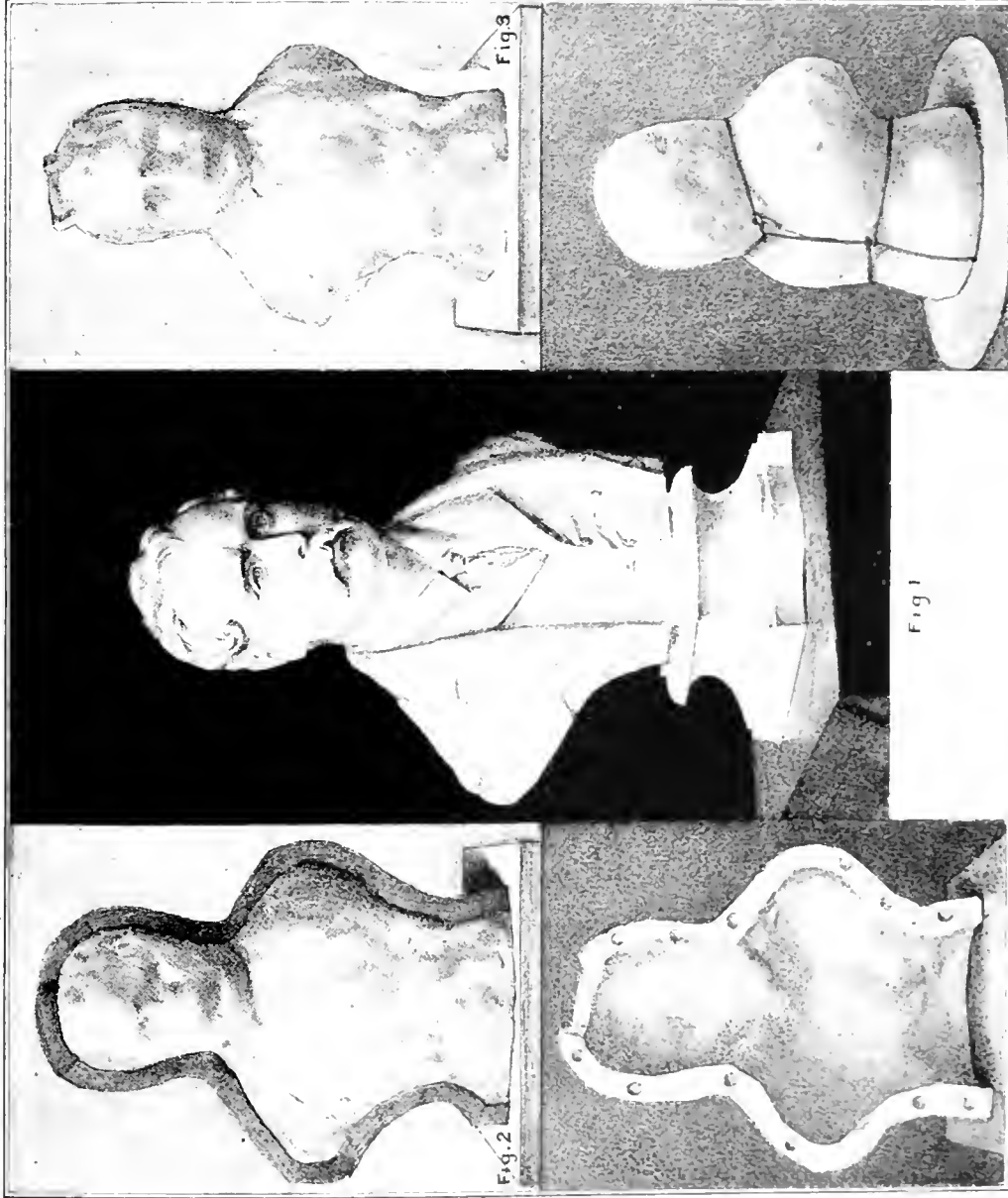

MODELING BUSTS IN GIPSUM

- Fig. 1. Model covered with thickness clay.
Fig. 2. Half-case.
Fig. 3. The Mold.
Fig. 4. Part of the Arm in gipsium.
Fig. 5. Model with thickness clay and bank card.

Fig. 4

Fig. 5

Fig. 1

Fig. 2

Fig. 3

mould (and the subsequent seams on the cast) on a plain part of the bust, and leave the features and ears clear. The case for the back part should be made first. This allows the bust to be laid flat when forming the front part of the case. Even if cased in an upright position, the back affords a firm stay when casing the front. Fig. 3 shows the same view, but with the back case made on the clay. The dark part at the top indicates where the opening is left to insert the funnel, also as a guide where to cut the jelly to form the two parts of the mould. This joint should be cut in a line with the joint of the back and front cases, so that the jelly joints will be flush with the case joints.

The joggles are made in the thickness of the case. The jelly is not so liable to escape as when they are made oblong in form on the outer edge of the case. The opening at the top is made larger than the end of the funnel, to allow for a small projection of jelly, which, being at the finishing part when being poured in, is usually partially composed of blubs or contained air. This part also affords a "catch piece" when separating the jelly from the mould or bust. Fig. 4 shows one-half of the case, and the joggles and funnel orifice. Fig. 5 shows the two halves of the case and mould tied up ready for casting. The rope is sometimes tied so that it does not cross the open or filling-in part of the mould. The method here adopted enables the mould to be hung, thus allowing it to be turned or rolled when casting hollow casts. The tension on the rope, caused by the weight of the mould when hung, keeps the joints of the case close.

BRUSHED GELATINE MOULDS.—A novel method of making jelly moulds has been employed by an American artist, who informs me that he has successfully used it for moulding statuettes. By this method no case or clay fences are required, the jelly, in a warm state, being simply brushed over the model until of the necessary thickness to form a mould. Not having seen this method used, or the resultant casts, I cannot venture on an opinion on its merits, but simply give it for what it is worth.

COMPOUND MOULDING PIECE.—When a large number of small plaster casts is required (such as beads, small bed moulds, &c.), fix from three to eight or even twelve casts on a plaster ground, and mould the whole in one operation. The casts for the moulding piece should be clean and sharp, and accurately jointed at both ends before they are fixed. This saves jointing the subsequent casts. Two or more designs, if nearly uniform in size, may be moulded in the same way. Three designs are given in the annexed illustration (No. 127) for other purposes, as well as a compound moulding piece. Firstly, to illustrate the employment of natural plants (slightly conventionalised) for enrichments, as a change from the ordinary foliage. The second purpose is to illustrate the various methods of jointing soffits or panels. When modelling, a little thought will enable a joint in continuous ornament to be made so as to cut through only a few stems, or parts having circular forms. A straight or nearly straight stem is easier to joint, also stretched or shrunk, than one which is circular. It must not be thought, from the above, that the design is to be sacrificed for the sake of the jointing, but taste and ingenuity combined may avoid a complicated joint without detracting from the design, and the modeller will have the satisfaction of seeing his work, when fixed, free from mutilation or stunted and distorted lines, such as are often seen when work falls into the hands of unskilled workmen, or the piecework master, or "slasher," whose catchword is "That's near enough," or "It won't be seen when the rooms are furnished."

Fig. 2 shows the section of the compound moulding piece, with the section of soffits, as already described. The ground of soffit A has a convex section. This joint (as its form shows) is called a "square joint." The ground B has a concave section, and the joint is called a "splay joint." The ground of C has a straight or level section, and the joint is called a "broken joint." The dotted

lines give the section of the ornament. When fixing three or four casts of the same design on a ground to form a compound moulding piece, it is best to take the casts from a wax mould, and undercut each cast by hand, before fixing them on the plaster ground. It is quicker to cast three or four lengths of an enrichment from a wax mould, because there is no seasoning

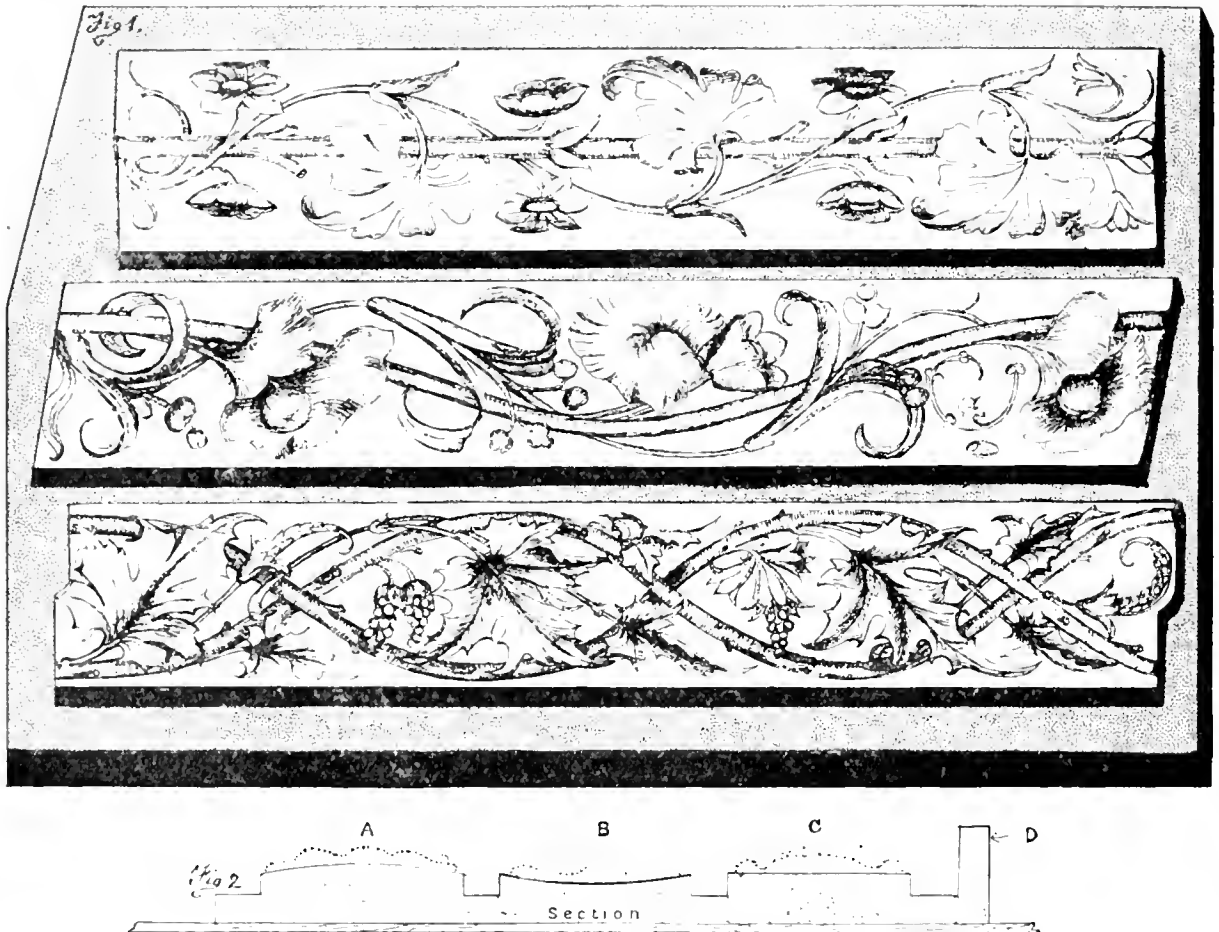

NO. 127.—COMPOUND MOULDING PIECE FOR GELATINE.

of the cast, or waiting for jelly to cool; and generally the first casts out of a wax mould are sharper than those out of a jelly mould, unless one has the best workmanship and materials. If the wax mould has to be taken from an undercut model or original, stop it down with clay or very weak gauged plaster. In the latter case, the parts must be soaped to allow the stopping to be removed after the mould is made. The undercutting of the casts by hand and the touching up can be slightly varied in each cast before being fixed on the ground of the moulding piece, and should be either done by the modeller or an artistic shop-hand, so as to give a freshness and crispness to the whole, combined with a well-balanced variety of detail. One end of this moulding piece is splayed to show that it is not necessary to have straight sides or ends, and that whatever form of joint the casts may have, the plaster ground of the moulding piece can be made to suit it, taking care to avoid acute angles, because jelly running to a thin point or angle is apt to dry, and consequently shrink or curl up. This moulding piece being flat, and the casts not

large—taking them as being about 9 inches long and $2\frac{1}{2}$ inches wide—no case would be required, only wood fences for the sides and clay fences for the ends. If the moulding-piece is a stock one, the side and end fences may be cast with the original. This makes a solid and permanent fence, as shown by the section at D, Fig. 2.

Stock moulding pieces are those which are kept to be used for other works. The same design is sometimes so often used, that one would think that there was no obtaining a new one no modeller to design and model one. The only stock moulding pieces that should be tolerated are classical works, such as the caps and the small enrichments of the five orders, antique figures, casts from nature, and masterpieces of design and execution,—these to be kept more for reference than for use. Some of the modern cornices, with two, three, and four enrichments, are repeated *ad nauseam*, and without regard to style and position. All enrichments should be designed to suit the height intended, and harmonise with the requirements and style of the construction.

MOULDING CLAY MODELS.—Several jelly moulds may be taken from a clay model without fear of injury to the model. The ground of the model should have a few flat-headed nails projecting above the surface to give a key for it. Should the model spring open at the surface joint, the clay must be carefully fixed by means of screws, and the holes stopped. The clay, when firm, is then carefully brushed with thin shellac. If the model is flat, it must be oiled and moulded in the usual way. If the model is deep, or if it is not desirable to make a case for fear of disturbing the model, a case may be made after the jelly is poured on. This is done by making a strong fence to retain the jelly. After the jelly is poured on, and allowed to cool, then remove the fence, and cut the excess jelly off, so as to allow the case to draw. The jelly surface is then brushed with a solution of clay, and the plaster poured on as before. Cutting the jelly in deep parts may be partly avoided by placing pieces of clay in the mould while soft, so as to displace the jelly. The clay pieces are taken out when the jelly is cool. The clay pieces are formed to the desired sizes before the jelly is poured on, and they should be firm and oiled before placing in the liquid jelly. Large pieces must be supported by means of wire to prevent them sinking on the face of the model. This process is useful where only a few casts are required. Owing to the clay having little or no suction, a jelly mould leaves a clay model much more easily than from a plaster moulding-piece.

MOULDING WHITE MODELS.—Sometimes a jelly mould is required to be taken from a white plaster or white cement cast, such as a bust or a plaque, without discolouring the model. This may be done by carefully brushing the surface with a solution of fine white curd or Castile soap. Care must be exercised that the surface be not too wet or too dry when the jelly is poured on. It is best to mould it when the surface is semi-moist, and has a glossy face. No oil must be used, and the jelly must be new and clean. After the mould is taken off, the model is wiped clean with a soft sponge dipped in warm water, and when dry it will appear as if untouched.

MOULDING CASTS.—It sometimes happens that a few undercut casts are required from old work, and that there is no stock original to be had. In this case it will be necessary to take one cast from the old work, and then clean and shellac it. It is then temporarily fixed on a plaster ground, with thin plaster or soft clay to keep it in position, and prevent the jelly running under the cast. A clay fence is fixed around, and moulded with jelly in the same way as described for open gelatine moulds.

OPEN GELATINE MOULDS.—Jelly moulds do not always require a case, but they may be made the same way as wax moulds; and if there are only a few casts required, wood or plaster fences will not only prevent the escape of the jelly, but act as an open case or support to the sides or ends

of the mould when casting. This is done in a similar way as described for front wax moulds. If the model is large or deep, and much undercut, the mould may be made in one piece, and the jelly afterwards cut to form a piece mould, to allow the cast to be taken out more freely. Models with long or large flat surfaces should be moulded open—that is, without a case. If there are circular casts required of the same model, in addition to straight casts, the mould having a level back can be bent to any curve by laying it on a cradle or a saddle made to any desired curve.

STRAIGHT MOULDS.—When casting long casts, such as panels, friezes, or mouldings, out of a gelatine mould, there is sometimes a difficulty in keeping the outer edges straight or level, which causes crooked casts. This is owing to the swelling of the jelly when the mould is new, or the shrinkage, if old. The edges are also liable to get torn by frequent handling when casting. The use of tacks or small nails driven through the jelly and into the case to keep the jelly in position has already been explained, and it answers for small work, or if a few casts are only required. A stronger and more reliable method is to strengthen the edges of the mould with laths or running rules. These are termed “stiffening rules.” The method of construction is illustrated later on.

GLUE MOULDS.—In some London shops glue is used for moulding undercut models. Glue is used as a substitute for gelatine, principally because it is supposed to be cheaper. The first cost is cheaper, but it does not follow that it is cheapest in the end. Glue may be used for casting large pieces of fibrous plaster work, or where the work is not required to be fine or sharp. Glue moulds are generally coated with a paint composed of gold size, patent driers, white lead, and linseed oil, thinned down with turpentine. This paint is also used for jelly moulds when casting Portland cement work, especially if the jelly is old or the cement slow in setting. It must be borne in mind that the originals should never be oiled with sweet oil, because it prevents the cohesion of the paint with the mould, and retards the drying. Some shop-hands use an oil composed of white lead, linseed oil, and turpentine, for oiling the original. This is intended for two purposes—first, to stop the suction of the original, especially if the original is composed with fibrous plaster; and secondly, to prevent the glue from adhering to the original, and also, “with good luck,” to settle as a paint on the surface of the mould. It may here be pointed out that the suction of fibrous originals is best stopped by first plunging them into water for a few minutes, or if too large or too thin on the surface to stand soaking, the front surface should be sponged with soapy water, and then the back brushed with a thin solution of clay. The clay keeps the moisture in the body, and prevents the suction of the porous plaster, and counteracts the heat of the jelly. After this, lubricate the original with a chalk oil, and the glue mould will leave the original freely and clean. This use of lead oil is a slow and dirty process, as it has to be washed off the original every time a mould is made. Painting glue moulds is also a slow and dirty process. The paints peel with every third or fourth cast, and require patching, and then waiting until dry. Painted moulds produce blunt and poor casts. Glue may be improved by any of the methods used for jelly. Old glue, like jelly, is improved by using stale beer, vinegar, or milk instead of water for dissolving purposes. Washing the face of the mould with paraffin oil before painting or varnishing indurates the surface. A limited number of casts may be obtained from glue moulds by using the best Scotch glue, and working it as described for jelly moulds. The use of a quick drying and elastic varnish gives far better results than oil paint. The following are the best known:—

RUBBER VARNISH.—Dissolve indiarubber shavings in naphtha in a close vessel by means of gentle heat (or a hot-water bath), then strain the liquid off into bottles, and keep them corked until required for use. Before varnishing the mould with this solution the surface must be dried by

dusting with French chalk, to absorb any surface oil or moisture which would prevent the varnish from adhering to the glue surface.

COPAL VARNISH.—A good varnish is made by mixing 1 gill of copal varnish with about 1 oz. of patent driers. The latter is thinned down with turpentine before mixing with the copal varnish. The mould is dusted as before, and then varnished, and allowed to stand until dry.

SHELLAC VARNISH.—This is made as follows:—100 parts water, 12 parts best hard shellac, and 4 parts of borax, are dissolved all together in close vessels by gentle heat and continued stirring. The vessel is then covered, and the liquid allowed to cool, after which it is poured into bottles which are well corked. This is used alone or mixed with a small portion of linseed oil and a few drops of turpentine. The whole mass is then well incorporated, and it will dry in fifteen or twenty minutes. Glue and jelly moulds that are used for casting with hot plaster or Portland cement are apt to become soft and sticky at the prominent or weak parts. In this case the moulds should be allowed to stand in a cool place until the parts are firm. They are then revarnished or washed with bichromate of potash as already described. Varnished moulds are oiled with chalk oil.

SOFT CASTS.—The surface of cast work taken from glue (and sometimes jelly) moulds is often partly or wholly covered with soft, sticky, or spongy parts. This is caused by hot plaster dissolving the surface of the jelly moulds, and dissolving or weakening the paint on glue moulds, thus preventing the plaster that is in contact with these parts setting as quickly as parts where the jelly or paint better resists the action of the heat. Soft parts on cast surfaces are also caused by using weak or slow-setting plaster, which takes longer to set on the face of the mould than that at the back or outside of the cast which is exposed to the air. Soft and spongy casts can be prevented by using alum water, which not only accelerates the setting and hardening of the plaster, but also hardens and preserves the face of the mould. If the plaster is very weak, or extra slow in setting, or the glue weak, and apt to spoil the cast, then use extra strong alum water, or a larger proportion of the ordinary alum water. This may cause the plaster to set too quickly, in which case add size water to regulate the setting. The addition of from 1 to 2 per cent. of sulphate of zinc will also neutralise the slow setting of the glue. Sulphate of zinc also indurates the mould and hardens the cast. The combination of two materials, each having opposite effects, the one hastening and the other retarding the setting of the plaster, may at first seem detrimental to the whole; but this is not so, as while regulating the quick and slow setting powers of each other, each has a separate hardening power, and when combined give still greater hardness to the plaster. This method is often used when casting fibrous plaster work.

SPOTTY CASTS.—Solid and fibrous cast work are both liable to be spotty, or have a discoloured appearance, more especially if produced from a painted glue mould. This is due to various causes, but principally to sulphur or lime, or both, in the plaster, drawing the oils from the paint and the glue to the face of the casts. If the plaster contains much sulphur, or if the alum used for gauging is not cleanly dissolved, they will discolour the plaster. Inferior or impure oils will also discolour the face of cast work. These bad effects may be prevented by mixing a little chloride of lime in the water used for gauging. The proportions vary according to the kind of plaster used, but are about 1 lb. of chloride of lime to 50 gallons of water.

GELATINE CASTS.—Shop-hands are sometimes called upon to mould and cast parts of the human body for surgical purposes. The following is the process as practised at the Royal Infirmary, Edinburgh.

PREPARATION OF THE MATERIAL.—Take of Nelson's "No. 1" gelatine, say 6 oz. by weight), soak it till quite soft and swollen, afterwards dry it slowly until just pliable. As it has

now the minimum of water necessary, melt it in a water-bath, and add 6 oz. (by measure) of clear glycerine (not necessarily purified). When the two are thoroughly mixed, the material is ready. To render it opaque, add, while it is still hot and therefore fluid, small quantities of a thick paint made by rubbing up oxide of zinc in glycerine. When a skin colour is wanted, a little vermilion is required to give a warm life-like hue. Should other things be cast, the prevailing colour can be given with water-colour as required (tubes of moist water-colour sold at twopence each will be found convenient). Several pounds of this may be made at once, and portions used as required.

MAKING THE MOULD.—From the part to be cast a mould in plaster of Paris must be taken in the ordinary way. It will be found best to limit the casts to those whose moulds can be removed from the living body or organ in one piece. When both sides are moulded at once, the gelatine cast is by no means easy to extract from the mould. After the mould has been removed from the body, it must be slowly and thoroughly dried. If the mould be moist, the gelatine cast is softened; if too much heated, the plaster itself crumbles. Besides the thorough drying, no other preparation of the mould is needed, but for convenience the margins should be banked up with clay before the cast is made.

MAKING THE CAST.—Melt the gelatine and glycerine previously prepared, and pour it into the dried and banked-up mould, being careful to roll the melted mixture backwards and forwards well over the face of the mould, so as to get rid of air bells. As the heated substance tends at first to run into the hollows, and leave the raised parts of the mould with a very thin coating, the operator must keep ladling up from the hollows, and as the substance cools, it will become sufficiently tenacious to remain on the upper parts.

MAKING A PLASTER BED FOR THE CAST.—While the cast is still in position in the mould, its reverse side must be covered with lint or wool, and this in turn covered with plaster of Paris, either pure or mixed with cotton wadding, oakum, lint, wood-wool, &c. This must be made to fit into the hollows and elevations of the back of the cast, and when set, it is to be removed so as to be dried. The cast can now be easily drawn or rather peeled out of the mould, and it will be found to be an elastic cast of what is wanted. When placed upon its plaster of Paris backing, it will preserve the shape which it had while on the mould.

TO PAINT THE CAST AS REQUIRED.—Use water-colour when a dry surface is to be imitated, oil-colours when the surface is moist. The water-colour may require several coats. Finally, an edging of black velveteen or other material will hide the irregular margin, and give a finish.

The advantages of this method of casting are its likeness in appearance and texture to flesh, and the great number of copies which may be taken from the same first mould. The disadvantages are the probability that it will not keep really good for more than five or six years, and the greater time required to make a cast in this than in plaster.

INDIARUBBER MOULDS.—Indiarubber has to a small extent been used for forming flexible moulds for casting undercut work and casts on the round. In 1875 G. Haseltine obtained a patent for flexible moulds. According to the specification, the model is first coated with a solution of indiarubber in benzene. This soon dries, and forms a sticky surface. Layers of vulcanised rubber, about $\frac{1}{16}$ inch thick, and cut into convenient sizes, are then pressed on the sticky surface. This is repeated until a body about $\frac{1}{4}$ inch thick, or as thick as will resist inward pressure when casting. If the work is on the round, the mould is cut at one side to release the model. If desired, the cut part can be securely joined again with rubber solution. The mould may also be held in its true form by a plaster case. Before using the mould it must be vulcanised. This form of rubber mould may be used for casting plaster or cement work. The durable nature of rubber moulds

enables them to be kept for an indefinite time, and they may be advantageously used for stock designs, especially for cement work, but their price is prohibitory for general purposes.

FIBROUS PLASTER AND CONCRETE FOR FIREPROOF CONSTRUCTION AND DECORATION.— This subject, being quite apart from that of gelatine moulding, may not appear to be in its proper place, but owing to the numerous and varied processes and materials that are used in plaster work, it is confessedly difficult to give an exhaustive description of each subject under one heading; therefore this, like others which are inseparable from other subjects, is given where occasion demands. Another reason is, that part of the sketches here given to illustrate gelatine mouldings also serves to illustrate the above subject. The various parts of fibrous plaster, concrete, and jelly moulding are shown in the following illustrations.

BALCONY FRONT.—The annexed illustration No. 128 shows a combined section and elevation of a balcony or box front for a theatre or music-hall. A small portion of the constructional work

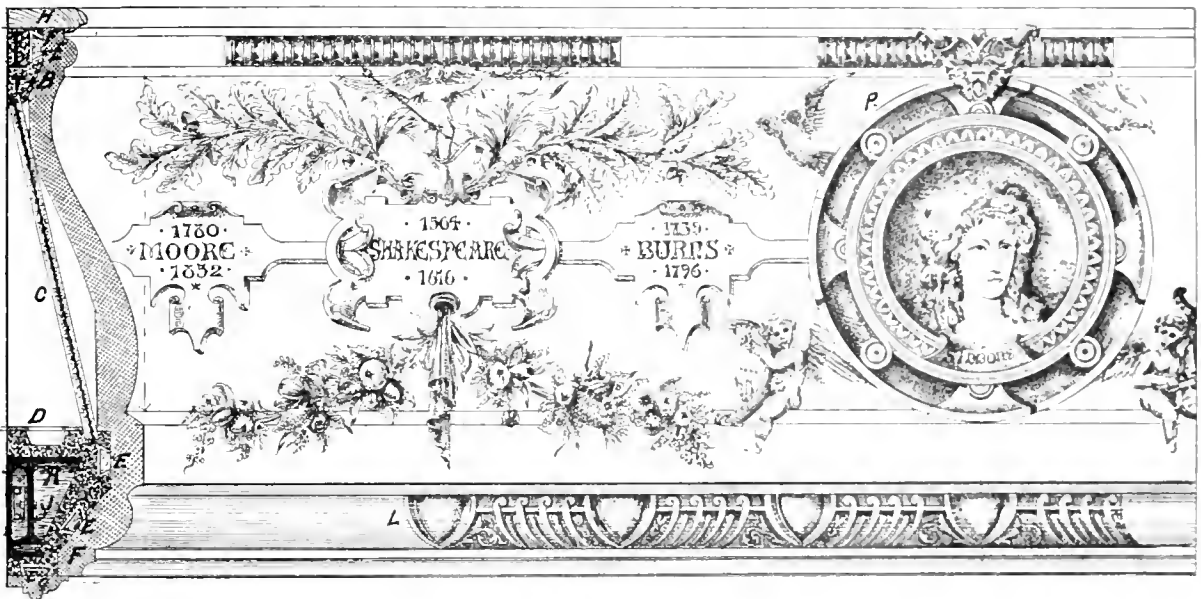

No. 128.—COMBINED SECTION AND ELEVATION OF A FIBROUS PLASTER BALCONY FRONT.

is shown to illustrate a method of constructing concrete in conjunction with fibrous plaster for fireproof, or correctly speaking, fire-resisting purposes. Fireproof construction is now, to a certain extent, compulsory, and being essential for the common welfare, every item, however small, should be of interest, and prove serviceable to constructive and decorative plasterers. The section shows a small part of the iron work. A is a side view of the end of a cantilever that springs from, and is supported by, the main walls; J shows the section of an iron joist, which is placed longitudinally between the cantilevers, and fastened with angle plates and bolts. The iron work is enveloped in concrete to protect it from heat and fire. T, T, and T are "fixing bars," which are made with a specially prepared concrete, and laid in position on the centring before the rough concrete is laid. It may here be stated that fixing bars are continuous in length, whereas "fixing blocks" are placed at intervals. The method of making both is described in Chapter XIX.

T is a section of a half of the top rail. This is formed with concrete and a T-iron in the centre. E is a fixing bar. The rails may be supported by iron posts or standards. C is a repr. of partition,

constructed with metal lathing plastered on both sides with concrete. This should be done before the fibrous work is fixed. The metal lathing is fixed at the upper and lower edges, which are let into grooves which have been previously formed in the concrete rail and floor. The partition can also be cast, and then fixed in position while the rail and floor are being formed. The rail can also be cast if required. When made *in situ*, a wood frame or box is formed around the joist, the top being left open to allow the concrete to be laid and rammed. The floor is formed in a similar way. The floor, partition, and rail can be formed in one monolithic body if required. This process would necessitate extra framing and a thicker partition, to allow the concrete to pass freely between the framing down to the floor. The main body of the floor is laid in the usual way. D is the flooring boards. They are fixed direct to the concrete to render the wood less combustible, and to avoid an intermediate space, which, in this position, would in a measure be a harbour for dirt and vermin, if not foul air. The board at D is removable, and the channel underneath it is a bed for water pipes, electric wires, &c.

F to F shows the surface section of the fibrous plaster box-front. The diamond hatching indicates fibrous plaster. The sections of enrichments are here omitted, but are shown on the casting moulds. G is a part of the soffit. This is set out so as to cover the joint of the box-front as shown, and is fixed to the fixing bar E. The top of the rail (H) is made of wood, and rebated to form a lap joint over the fibrous plaster. The top can also be formed with carton-pierre or with papier-mâché, and then stained and varnished or polished as required. These materials are superior to most woods in point of resistance to fire. The fibrous front is secured by screws, which pass through the frame and fixing laths in the cast, and into the fixing bars in the concrete. The weight of the fibrous front is, in this instance, supported by the ledge on the concrete floor, therefore screws at wide intervals in the three fixing bars will securely hold the front in position. The upper and lower mouldings (especially for balconies with many and various curves) are sometimes run in "solid plaster," and the main panel and the enrichments cast in fibrous plaster. The enrichments are sometimes cast in plaster, carton-pierre, papier-mâché, and in composition. Fibrous plaster has the advantage that it can be made lighter and in larger sections, also fixed with greater expedition than any of the above materials.

This fibrous front would be jointed at the centre of the circle panel, these circle panels being cast separately, and when fixed they cover the long vertical joints on the main casts. The grotesque head is added after the centre panel is fixed. The lower bed-mould (L) is jointed through the egg, as indicated by the dotted line, which is the joint of the main cast. This centre egg may be cast separately and fixed after the main cast. This enables the main cast to be made with a straight joint. The foregoing details will enable the general construction and fixing of the work to be better understood. With regard to the moulding piece, a running mould is cut to the section from F to F, taking care to allow a bed for the bottom enrichment (L), and the top enrichment. The main panel extends from one circle panel to the next circle panel, and the depth is the space shown by the dotted line from dart to dart. These items are here given for future reference. A sufficient length of the section is run, and on this the ornamental work is modelled. The bust of Sarah Siddons has been chosen for this panel, because she was not only the "Queen of Tragedy," but also, like Sarah Bernhardt, the great French tragic actress of to-day, she had great talents as a modeller. She modelled a bust of her brother, John Philip Kemble, in the character of Coriolanus, a statue of Brutus, a bust of President Adams, and many other works of art. The other panels required to make up the circuit could be enriched with busts of other Thespian and musical celebrities and men of letters. It will be seen that the bands between the

eggs in the enrichment (L) can be used in two separate forms. They can also be used together, so that the bands will turn in and out from the eggs alternately. The method of making the circle panel is as follows:—

CONCAVO-CONVEX MOULDINGS.—The section of the circle panel, on plan, is the same as the section of the main panel (shown in the previous illustration), and is termed "concavo-convex," *i.e.*, concave one way, and convex the other. This form of moulding is made on a plaster ground, having the same contour as the desired concavo-convex panel. The section of this ground is shown at A, Fig. 1, in illustration No. 129. This ground is run with the same running mould used for running the main part of the model, but it must be slightly altered before running this ground. This is done by fixing two pieces of sheet-iron or zinc on the original mould plate, one at the bottom to cut off part of the moulding (as shown by the dotted line at D), to allow the slipper of the panel running mould to pass and run on the same line of section as the nib, thus forming the panel moulding to a regular curve; or, in other words, forming the whole width of the moulding at this part to the section of the main panel. The other piece of iron is fixed in a similar way to cut off the moulding at the top of the main panel as shown by the dotted line at E. This is done for the same reason as already mentioned, as well as to obtain a more graceful side section, and less projection at the crown of the circle, to allow for a proper section for the grotesque head, as shown at C on Fig. 2. The dotted lines at D and E represent the parts of the upper and lower mouldings that spring from

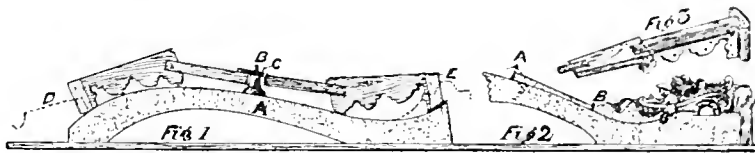

No. 129.—RUNNING CONCAVO-CONVEX MOULDINGS.

the main panel. The running mould for the circle panel moulding is so constructed that it will fit the various curves. This is done by rounding the nib, and using a short and oval-shaped slipper, so as to have a small bearing. The radius-rod works on a pin, which passes through the "slot," to allow the mould to take the up and down curves. A centre plate is fixed on the centre end of the radius-rod. A centre hole is made to fit the centre pin. This plate is made of flexible metal (a piece of hoop-iron will answer the purpose), to yield with the rising and falling of the radius-rod and mould. Fig. 3 shows the mould with the radius-rod. The mould is shown in two positions (one at the concave and the other at the convex) on the ground in Fig. 1. B is the centre block and pin; C is the centre plate. The centre block is raised to equalise the height and depth of the two opposite curves. When running the mould, the centre plate should be kept down on the centre block to obtain a uniform radius. The mould should be made so as to run about 1 inch of the background; the space shown by the line from B to A on Fig. 2. The remainder is made up by hand and the aid of a template. After the circle moulding is run, the straight mouldings at each side of the circle panel are made up to the original section, or in other words, to butt against the circle moulding as expressed by the dotted lines at D and E. This making up is simply putting on what was taken off the original section, and is done to allow the panel to be moulded to the section of the main panel, so that the panel casts will fit with a close joint when fixed on the main cast. After this a part of the top rail should be fixed in position, as shown at H on Fig. 2. This gives a ground for modelling and moulding the grotesque lion's head, also a

better idea of the general effect when modelling. Before commencing the modelling, the circle panel and the main part of the front should be placed upright and temporarily fixed, so that the work can be viewed as a whole, and in a similar position to the permanent one.

MOULDING BALCONY FRONTS.—The moulding with jelly of the balcony front now claims attention. Illustration No. 130 shows sections of the moulding piece, jelly mould, and a fibrous plaster case. A is the ground, and B the body of the moulding piece. The back section of the body is the same as the structural work of the balcony front, or as shown on the previous illustration. The moulding piece can be made in two ways. The first way is done by running a sufficient length of ground to take two or more lengths of the original cast to be fixed on it, allowing a space at each end for moulding purposes, this space being equal to the thickness of the jelly and case. The original cast with the modelling is moulded, and as many casts got out as required for the moulding piece. The casts are then fixed on the ground, taking care to leave both ends jointed. The second way is to make up the ground at the sides and ends of the original cast, so as to make a moulding piece. In most works the back section need not be fitted so accurately as here shown. This example is given to illustrate the method of obtaining a perfect fit or bed where required. A fixing point at the top and bottom of the cast is sufficient in most cases. It will be seen that the first method is similar to making an original for a small bed-mould, &c. Large clay models of this nature should be moulded direct from the clay, so as to retain all the modeller's original touches and effects. This process dispenses with waste moulding

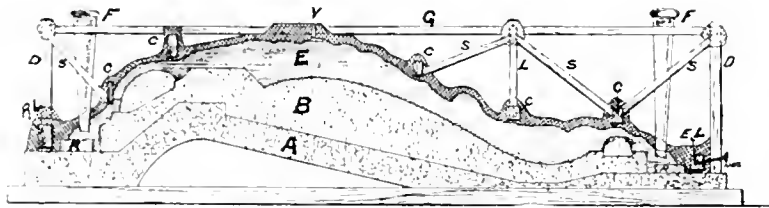

NO. 130.—SECTION OF MOULDING PIECE, WITH JELLY MOULD AND FIBROUS PLASTER CASE OF BALCONY FRONT.

and cleaning up. A novel method in connection with moulding balcony fronts, or other long jelly moulds, is that of using wood rules, termed "stiffening rules." They are used as a substitute for the lips, which are generally formed in solid cases to keep deep or long sides of jelly moulds in position, so that they will keep straight, and yield straight casts. The use and method of making stiffening rules, in conjunction with a fibrous case, is as follows:—

STIFFENING RULES.—Stiffening rules are used to hold long sides or other straight parts of jelly moulds in position, so that they will be stiff and straight, and prevent twisting or drooping, thus ensuring true and straight casts. Stiffening rules are a part of the mould, but an allowance for them must be made when making the case. Stiffening rules are made of pine boards, and are about 1 inch wide, $\frac{3}{4}$ inch thick, and in lengths as required. They should be planed on all sides, and tapered on the sides that project or fit into the case, so as to allow the case to draw from the mould, and *vice versa*. When making the case, the stiffening rules are laid on the ground about $\frac{1}{2}$ inch from each side of the model, and then the thickness clay is laid in the usual way, taking care to lay it about 1 inch over the rules, which leaves a $\frac{1}{2}$ -inch bed in the case. Take E in illustration No. 130 as thickness clay, and this process will be more clearly understood. R and R are sections of the stiffening rules, showing their positions and splayed edges. It will be seen that one side beds into the case, and that the other side and the greater part of the top is bedded into the

jelly. Stiffening rules also enable long or large jelly moulds to be taken more easily off the original, and with less risk of the mould tearing. This simple but useful method was introduced by my son, James Millar.

TO MAKE A FIBROUS PLASTER CASE.—The introduction of fibrous plaster cases is of recent date, and was invented by Tom Sweeney, formerly an employee of Messrs G. Jackson & Sons, but now shop foreman for Mr J. Rule, of Sunderland. They are of advantage for large moulds, as, being lighter than solid cases, they are more easy to handle when casting. Instead of a large number of vents, as required for a solid case, one vent is generally sufficient for a fibrous case. A passage for the air is obtained by puncturing the surface. These punctures, while allowing the air to escape, will not allow the jelly to do so. This process is not only cleaner, but is also quicker than forming clay dots for the vents when making a solid case, and stopping the vents when moulding. The method of making a fibrous case is elucidated in illustration No. 130.

Having laid the stiffening rules in their positions, the thickness clay and the clay dots for the funnels (F and F) and the vent V are then formed. The vent should be midway between the funnels. For a mould this size (about 7 feet long and 3 feet wide), four funnels will give better results than two, because the jelly is not so apt to cool and crease, by travelling over a long surface, as when four are used, by which the intermediate space is decreased. For an original of this section, funnels should be placed on both sides, so that the jelly will run up on both sides to the vent. If they were placed on one side only, the jelly would run up to the top of the original, and then down on the other side. The latter part is bad in practice, because when the jelly runs down it is liable to retain a part of the contained air, thus causing blubs in the mould; whereas, by running up, the jelly forces the air up and out at the vents.

A fibrous plaster case being very thin (from $\frac{1}{4}$ inch to $\frac{1}{2}$ inch thick in most parts), it is necessary to strengthen it with strong laths, and in order to form a background, so that the mould will lie true on the bench when casting, two deep frame laths are required. They also support the case. These laths are laid from end to end of the case, and are inserted while the case is being made, and they are further secured by means of wood stays and rib laths, which are laid crossways, so as to bind and stiffen the longitudinal laths. They are fixed with plaster and canvas, and in some instances with screws or nails. Where practicable, the frame laths and the rib laths should be nailed together before they are inserted in the plaster and canvas. This nailing together makes a frame, which is laid on while the case is being made, and is much stronger than if laid in parts and fixed with plaster and canvas. After laying two coats of plaster and canvas (one coat will suffice for small cases), the rim laths (R.L. and E.L.) are laid, and then the overlapping canvas is turned over and brushed with plaster. The body laths (the five C's) are then laid and covered with canvas strips and plaster brushed. The frame laths (D and D) are next laid. Two ways of fixing are shown. One is laid on the rim lath (R.L.), and is fixed with brushed canvas strips; the other is laid against the rim lath (E.L.), and fixed with nails. The frame laths are further secured by rib laths (G), which are placed at intervals about 3 feet apart, and fixed with nails or brushed canvas strips, and further supported by the stays (S and S). The upright stay (L) supports the body lath beneath, and offers a fixing point for the angle stays to support the remainder of the body laths. The top points or bearings at the frame and upright laths, the vent and body lath, are floated level. The fibrous plaster is indicated by the diagonal cross lines. The rim body laths vary in size from $\frac{1}{2}$ inch to 1 inch thick, and from 1 inch to 2 inches wide; and the frame laths from $\frac{1}{2}$ inch to $\frac{3}{4}$ inch thick, and the widths as required. It will be understood that the plaster and canvas and the laths are laid and brushed as described for plain fibrous plaster panels. When the case is taken off the

original it is cleaned, and then punctured. This is done with a fine and sharp pointed bradawl, stabbing it from the inner surface, so as to leave the perforations clean, and without ragged edges. The perforations are made at random about 1 inch apart, and near the highest points, or where vents would be made in a solid case. The case is then seasoned with shellac in the usual way, and then the stiffening rules are inserted, and it is ready for use.

Before laying the case on the original, the stiffening rules must be temporarily fixed in the case beds to prevent them moving out of position, or falling while turning the case over and fixing it, also while the jelly is being poured on. The rules are fixed with a solution of clay, or with screws inserted through the case from the outside. It is very difficult to place them truly on the ground of the original, therefore the latter way is the best. This done, the case is oiled in the

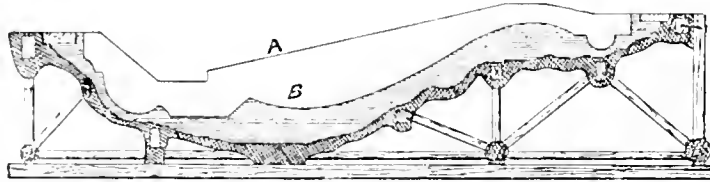

No. 131.—SECTION OF JELLY MOULD OF BALCONY FRONT.

usual way, but taking care not to oil those parts of the stiffening rules that the jelly covers, as otherwise the jelly would not adhere to the rules, which would render them useless for the desired purpose. The mould is then made in the usual way, and when the jelly is cool the screws are extracted to allow the case to be taken off and leave the rules as a part of the mould. The next part of the process is the casting, which is done as follows:—

CASTING BALCONY FRONTS.—A section of the casting mould is shown in illustration No. 131. A is the ground line at the ends of the case and from which the back surface is ruled off. B is the section of the face surface, the outline of the ornament being in the jelly thickness. The sections of the various case laths and the stiffening rules correspond with those in the previous illustration. Illustration No. 132 shows the section of the cast. A and A are wood blocks

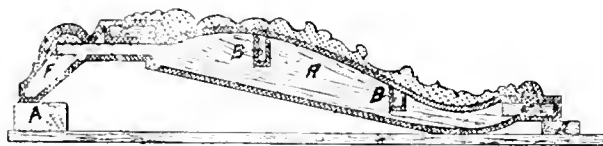

No. 132.—SECTION OF CAST OF BALCONY FRONT.

which are used to support the overlying edges of the cast and prevent it from warping while it is drying. The casts are made as fibrous cornices, but the laths are stronger to carry the weight of the larger casts. F and F are frame laths, each 3 inches wide and $\frac{3}{4}$ inch thick. C is a body lath (but laid flat for fixing purposes). This and the body laths B and B are 2 inches wide and $\frac{1}{2}$ inch thick, and R is a bracket $\frac{3}{4}$ inch thick, and cut to fit over the body laths. The brackets are placed from 2 to 3 feet apart. The cast is strengthened by nailing the frame laths and the end brackets together so as to form a complete frame. This is placed on the mould after the plaster and canvas is laid. The canvas margins are then turned over and brushed, and the body laths and the intermediate brackets laid in between the frame. The whole of the wood work is canvased

and brushed with an extra thickness of plaster, as shown on the back section of the cast, to enable the work to better resist fire.

CASTING IN LARGE GELATINE MOULDS.—When filling in this or other large jelly moulds for fibrous work, alum water must not be used in the firstings. Alum water is only used for small work or for solid casts, to hasten the setting of the plaster, so that the cast can be quickly taken out of the mould before the plaster begins to heat. Alum tends to increase the heat of the plaster, therefore this heat, when filling in large moulds (which sometimes require from one to three hours to fill in), would injure the face of the jelly. The heat is avoided by using size water in the firstings. This also gives time to lay and brush the canvas. The firstings must be gauged stiff, only using as much size as will cause it to set just a little before the seconds sets. Alum and size water combined—as used for “soft casts”—is often useful for this work.

CIRCULAR BALCONY FRONTS.—Balcony, box, or gallery fronts are seldom wholly straight on plan, but more often contain circular parts—in fact some have no straight parts, for instance, the horse-shoe plan. Great expense would be incurred if a separate moulding-piece and mould were made for each curve. This is avoided by recasing the straight jelly mould, so that it will produce casts to fit any curve or combined curves. The recasing is accomplished as follows:—When laying the thickness clay to make the case for the straight jelly mould, run the clay surface with a wood template cut to fit the clay section, and bear on the side grounds of the moulding piece. This is termed a “clay template,” and forms a uniform sectional clay surface. Then make the case in the usual way, and get out as many straight casts as will be required. Make another case to the desired curve. This is done by cutting two “case templates” to the desired curves, one to fit the upper radius, and the other to fit the lower radius at the springing or ground lines of the cast. This difference of the radius lengths will be better understood by looking at the section on illustration No. 128, where it will be seen that the back line of the cast at *F* and *F* is not perpendicular, or, in other words, the projection of the ground of the cast is greater at the bottom than the ground at the top, therefore the radius for the latter would be greater than that for the former. If both edges of the cast sprang from a straight line, one radius would answer for the two templates. For convex work the radius must be reversed. Having got the case templates cut, they are then fixed on edge. The distance apart is equal to the width of the straight case. If the curves of the templates are acute, they should be lathed on the bottom edges, or the ends made up with bricks to form a rough core, so as to obtain a fair thickness for the plaster case. The space between the templates is filled in with plaster and run with a “bed template.” This is cut to the reverse section of the clay template, and made to bear on the case templates. When the bed and sides of the case are run, it is then varnished with shellac, and the jelly mould taken out of the straight case and laid in the circular one. The ends of the case are then made up to the mould with plaster, thus completing the circular case and mould. If the ends of the jelly mould have acute points, or are too thin at parts to retain their original forms when laid in the circular case, the inside ends should be stiffened with plaster. Before the mould is taken out of the straight case, and after the ends of the circular one is made up to the stiffened ends, the plaster is taken out of the mould. If stiffening rules are used in the straight mould, they must be made with a series of saw cuts to allow them to bend to the circular case. They are useful as fixing points for nails to keep the mould in position when laid in circular cases.

Where there are parts of enrichments that project above the general clay thickness and which prevent the clay template from passing, the template must be worked close up to the projecting part and the intermediate spaces ruled off by hand, the projecting parts are then covered with

the usual thickness of clay, and the whole cased and moulded in the usual way. Provision for the projecting parts must be allowed for when making the circular case. This is done by setting out the positions of the projecting parts on the rough core of the circular case, and then placing clay blocks on the core where marked. Each block must be larger in depth and width than the part that it is meant for, and the upper surface of the blocks made in a line with the bed of the case. After the case is made, the blocks are taken out and the mould laid in. The projecting parts drop into the cavities made by the blocks. The exposed jelly at the back of the case and the excess space of the cavities are covered and made up with plaster. If the projecting parts are deep or the jelly thin, they should be made up with clay or filled in with plaster before the mould is taken out of the straight case. This enables them to retain their original forms when placed in the circular case, and while the cavities are being made up. It will be seen that by the whole processes straight and circular casts of any curve can be produced from the same mould. Another way for getting over the difficulty of projecting parts (when the mould is required for circular work) is done by cutting them off, and then moulding and casting them separately, and afterwards fixing them on the main cast. When making the model and mould for a front on a circular balcony, having no straight parts, similar to the horse-shoe plan, the plan section for the model should be taken at the part having the longest curve, and then circular cases made for the others.

INTERCHANGEABLE MOULDS.—It is sometimes desirable to change parts of a mould at will, especially where minor parts of the main design are only used once, and different designed parts used for the repeated main design. For instance, the names and dates on the name panels (as shown on illustration No. 128) would not be used again, but other notable names, with their respective birth and death dates, used for each repeated main design. Name panels, with interlacing strapwork and scroll bands, when amid foliage, fruit, flowers, and figures, form a pleasing change and a relief to the eye. The panels being enriched with the names of eminent people, with the dates of their birth and death, are instructive as well as decorative. When viewed as a whole, the varied names and busts constitute an appropriate and artistic finish.

Interchangeable moulds are constructed by making a separate mould for each changed part, and letting it into the main mould, somewhat as in constructing a mould for a fibrous cornice with "cast enrichments." A bed in the case, and a space in the mould for the changeable part, is formed before the case is made. This is done by making a plaster "bedding piece" on the model to the size and form of the proposed changeable part, taking care to allow for a sufficient length for the longest name in the list, and that is about $\frac{1}{4}$ inch thicker than the thickness clay. The form of a piece is indicated by the dotted line on the "Moore" panel, illustration No. 128. After the bedding piece is made, the thickness clay is laid in the usual way, laying it close up to the bedding piece, so that it will have a $\frac{1}{4}$ inch projection on all sides above the level of the clay. The case is then made, and when taken off, the bedding piece is taken out, and moulded for future use. The piece is then replaced on the model, and the main mould made. The bedding piece is next taken out, thus leaving a bed and space for the changeable moulds. The mould of the bedding piece is filled in, and the cast forms a ground for the modelled work. This is then moulded, making it a little thinner than the original, to allow for bedding purposes. It is laid in the main mould, and the whole mould filled in. When the cast is taken out, the thin seam, caused by the bedded part, is cleaned off. The mould of the bedding piece is used in a similar way for any required number of changed parts. This process is only used where thin casts are required for special purposes, and as the names and dates may be painted, or still better, modelled with gesso, or with tow plaster, on the panels when cast, the process will also serve for moulds where

there are a series of medallions on a repeated main design. The names, medallions, or other changeable parts may also be made separately, and the casts laid face downwards, and canvased and brushed with the main cast, as when making fibrous cornices with bedded casts. In fact, this is the most suitable way for most purposes, as the casts are thin and strong, and have little or no seams to clean off. Changed parts may also be cast separately and fixed on the main casts, but special care must be taken when fixing the parts, so that the joints will not open when subjected to the alternate extreme heat and cold that is often found in theatres and halls.

COMBINED GELATINE AND PLASTER

MOULDS.—A jelly mould in combination with "plaster pieces" is advantageous for moulding models having large plain parts, or with deep sides, or where interchangeable parts are required. An example of using a plaster piece for a plain part is shown in "truss moulding." The methods of formation for the other parts are as follows. Illustration 133 shows a part elevation of a panel for theatre proscenium, which is given as an example for moulding purposes.

The method of moulding is elucidated on illustration No. 134. This shows a section of the model (A), which is a section of the panel. It may here be noted that this panel (and similar models having strong edges) does not require plaster "moulding ground," but the original model is simply made and moulded on the moulding board M. If a back section to fit any constructional work is required, a plaster block, cut to the section, is fixed at each end of the model (as shown at P). They form the bearings for ruling off, thus making the whole into a moulding piece without running a profile or bed. Taking the length of the panel (when completed), as being about 12 feet, and the depth at the sides 5 inches, it will be seen that if moulded with jelly down to the moulding board, the sides of the mould, being a pliant body, and in an upright and partly unsupported position, would incline inwards through force of their own weight, and consequently cause the sides of the ensuing casts to be more or less wavy.

These defects are avoided, and the quantity of jelly reduced (which is a saving in large moulds), by using the plaster pieces B and D. Two ways of forming these pieces are shown. The upper edge of the piece B is made above the level of the jelly joint, and sloped to the arris of the model to allow the mould to draw. The raised ridge forms a corresponding groove in the case, which acts as a joggle and keeps the piece in position, and prevents it from slipping inwards. The edge of the piece D is made flush with the arris of the model, and is held in position by means of round sunk joggles

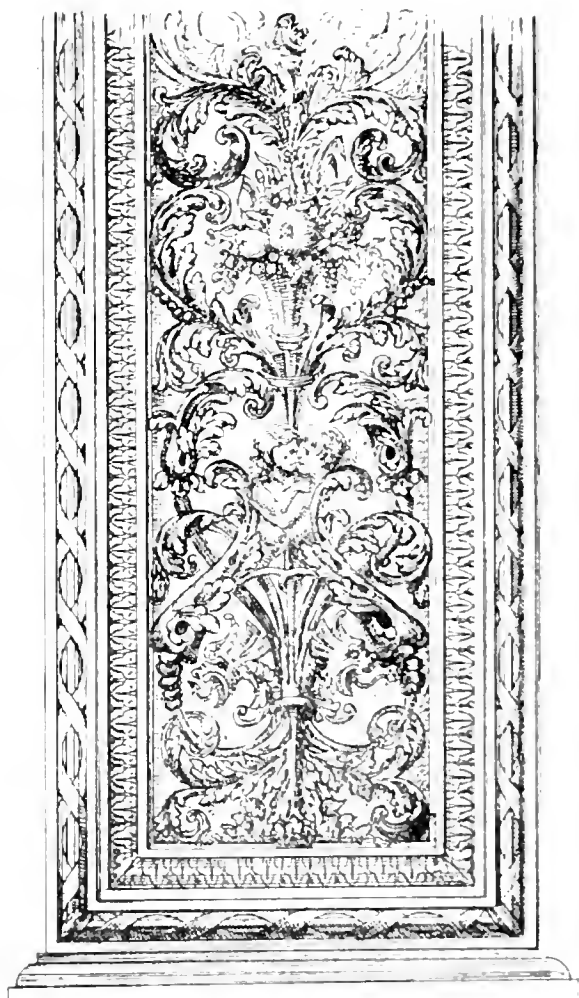

NO. 133. THEATRE PLASTER PANEL FOR PROSCENIUM.

placed about 9 inches apart. The flush edge has this advantage, that it allows the jelly to overlap the joint, so that if it did shrink a little while the mould was in use for casting, it would still cover the joint, whereas the raised edge forms a butt joint; therefore, in the event of the least shrinkage of the jelly, the fluid plaster, when casting, would run into the open joint, and cause a bad seam on the arrises of the casts. Similar pieces are made at the ends of the model. Should the long side pieces break while the mould is in use, the broken parts are laid in the mould, and the joggles will keep each part in its own place, as with a piece mould, and still be fit for use. Both methods are used for "plaster piece moulding," but the "flush edge," or joint, is the best. After the plaster pieces are made, the thickness clay is laid as already described. Another use of stiffening rules is here shown to illustrate a method for keeping any desired interior part of a jelly mould straight and always in one position. This is often desirable in large moulds where there are delicate mouldings in the design. In the present example they are placed over the inner members of the panel mouldings, as shown at *k* and *k*. They are made about $1\frac{1}{2}$ inches wide and $\frac{1}{2}$ inch thick, and in suitable lengths, and are sloped on both edges to allow the case to draw. They are bedded $\frac{1}{4}$ inch in the thickness clay, which allows $\frac{1}{2}$ -inch bed in the jelly and in the case. When bedded in the thickness clay, the exposed part should be shellaced and oiled to prevent their swelling, and to allow the case to draw freely. After the case is taken off and shellaced and oiled, the

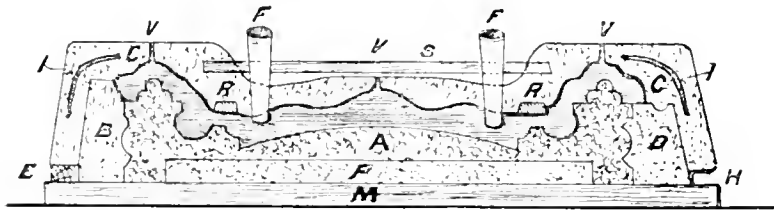

NO. 134.—SECTION OF MOULDING PIECE, WITH JELLY MOULD, PLASTER PICES, AND CASE FOR PROSCENIUM PANEL.

rules are laid in the case but not oiled, so that the jelly will adhere to them, and temporarily fastened by means of screws as already described.

The plaster pieces being sufficiently strong in themselves to keep rigid, it is unnecessary to form the sides of the case (C) all the way down to the board. Any desired depth and thickness of the sides is obtained by laying a rule close to the plaster pieces as shown at *E*, and when the case is finished, the rule leaves a "hand space" for lifting the case off the mould, as shown at *H*. Large cases which have to support heavy plaster pieces are strengthened by angle-iron, as shown at *I* and *I*. They are placed about 3 feet apart. Angle irons are also placed in each of the angles on plan. Wood stays as shown, at *s*, are placed at intervals to prevent the case collapsing while being turned over when casting. Cases for large moulds, also plaster pieces, should be made with a good inward slope, so that the casts can be taken out without turning the case and mould over. Large casts are more easily taken out of an open mould by using "hand rules," as already described. The *V*'s are vents. The upper ones are made about 1 foot apart, and the lower ones 2 feet apart, taking care that one of each row is made at both ends of the case. The funnels *F* and *F* are placed at the lowest parts at each side of the curved centre, so that the jelly will run upwards in both directions. Their longitudinal position should be in the centre of the mould lengths, so that the jelly will run equally both ways.

CHAPTER XII.

FIBROUS PLASTER WORK.

HISTORICAL.—FIBROUS PLASTER BEFORE THE CHRISTIAN ERA—FIBROUS PLASTER CEILINGS USED IN CAIRO IN THE FOURTEENTH CENTURY—USES FOR FIBROUS PLASTER—RENOVATING OLD CEILINGS—FIBROUS PLASTER FOR PANELLIED CEILINGS—FIBROUS PLASTER NOMENCLATURE—FIBROUS PLASTER MATERIALS—CUTTING CANVAS—FIBROUS PLASTER WOODEN LATHS—FIBROUS PLASTER CASTING—CASTING FIBROUS PLASTER CENTRE FLOWERS—UNDERCUTTING FIBROUS PLASTER—FIBROUS PLASTER CORNICES—MITRE AND JOINT STOPS—CASTING FIBROUS PLASTER PLAIN CORNICES—CASTING FIBROUS PLASTER ENRICHED CORNICES: BEDDED ENRICHMENT SYSTEM—MOULDING AND CASTING FIBROUS ENRICHMENTS—CASTING FIBROUS PLASTER ENRICHED CORNICES: FIXED AND CAST ENRICHMENT SYSTEMS—FRAME WAX AND GELATINE MOULDS—FIXING FIBROUS PLASTER CORNICES—FIBROUS PLASTER MEASUREMENTS—FIRE-PROOF FIBROUS PLASTER—FIBROUS PLASTER DECORATIVE SHEETS—MUSLIN PLASTER CASTS—TOW AND PLASTER CASTS—RAPID PLASTERING—FIBROUS PLASTER SLAB MOULDS—FIBROUS PLASTER SLAB MAKING—SETTING FIBROUS PLASTER SLABS—FIREPROOF, SALAMANDER, COMBINATION, METALLIC, EXTERNAL, REED, GROOVED, PERFORATED, FINISHED FACE, GESSO, SGRAFFITTO, FRESCO, AND PUGGING FIBROUS PLASTER SLABS—HARDENING AND DAMP-PROOFING FIBROUS PLASTER SLABS—FIXING FINISHED FACE SLABS—FIBROUS PLASTER SIGN-BOARDS AND BLOCKS.

HISTORICAL.—Fibrous plaster was patented in 1856 by Leonard Alexander Desachy, a French modeller. The patent was for "producing architectural mouldings, ornaments, and other works of art formed with surfaces of plaster." The materials named are plaster, glue, oil, wood, wire, and canvas, or other woven fabric. A part of the specification reads: "To facilitate the fixing of such moulded surfaces to other surfaces, wires are, when required, laid into and between the two or more layers of canvas. Flat surfaces are strengthened with canvas, wires, hooks, or pieces of wood may be inserted whilst the plaster is in a fluid state." The specification also includes the formation of solid slabs of plaster strengthened with two layers of canvas in the centre. Desachy introduced the manufacture of fibrous plaster decorations into London, where he employed a large number of hands, male and female. The late Owen Jones, architect, and the author of "The Grammar of Ornament," was the first patron of fibrous plaster. Desachy, after a precarious run of work, returned to Paris. The business was then for a time carried on under the management of J. McDonald and R. Hanwell, respectively foreman and modeller to Desachy. When Desachy retired from the business, he was pecuniarily indebted to Owen Jones, which handicapped the efforts of McDonald, and the business was eventually taken over by Messrs. G. Jackson & Sons, London, who acquired the then existing patents. They have introduced many improvements, and brought it to a high degree of perfection. During the construction of the old Oxford Music Hall, about a generation ago, they successfully defended their patent rights. Fibrous plaster during the last two decades has been worked by other firms, and it is now open to all plasterers. Such is the British history of fibrous plaster. It is an old saying, that "there is nothing new under the sun." This may be safely applied to fibrous plaster, as the use of linen and canvas, in conjunction with plaster and glue, was known and practised by the Egyptians long before the Christian era. From ancient MSS. still extant, and ancient coffins and mummies, now to be seen in the British Museum, it is

conclusively proved that linen, stiffened with plaster, was used for decorating coffins, and when embalming human bodies by the Egyptians, 1500 B.C. Dr Petrie's discoveries at Kahun go even further, for he found that plaster and canvas were used for casting mummers' masks nearly 4,400 years ago. Plaster, canvas, glue, and wood were used in the formation and decorations of ceilings in Cairo eight hundred years ago.* According to the MS. of Cennino Cennini, who wrote in 1437, fine linen, soaked in glue and plaster, was used for forming grounds on wood intended to be painted on.† Thus it will be seen that plaster combined with linen has an ancient as well as a modern history. Plaster mixed with tow was used for the decorations of a church in Hamburg about two hundred years ago. While giving Desachy the honour of reviving the process, and of introducing it into England, it is more than probable that he got the idea from some of the French writers—Reinaud, Prisse D'Avennes, Girault de Prangey, or others, who had very fully described and illustrated Egyptian arts and architecture. Coming nearer home, it will be found that canvas has been used for ages for another plastic purpose. Canvas and mortar were in everyday use in Great Britain up to the middle of the present century as a heat-resisting plaster. It is still to a small extent employed in some districts, but its general use ceased after the introduction of Portland cement. Canvas was used as a binding power to prevent the mortar round wash-house coppers from cracking or expanding when subjected to heat. The mortar was composed of equal parts of haired lime and gritty road scrapings. Sometimes clay was substituted for the scrapings, but more often all the three stuffs were well worked together. The walls of the copper were rendered with this mortar, and allowed to stand until the next day. Then it was floated with the same kind of stuff, and while soft, a sheet of strong coarse canvas was laid over the mortar, and pressed and patted with a hand-float into the mortar, and then trowelled. I have found that this canvas plaster, after many years' wear and exposure to heat and damp, was extremely hard and tenacious when being pulled down for alterations.

USES FOR FIBROUS PLASTER.—Fibrous plaster is an important branch of the plasterer's craft, and is now in great request by architects, builders, and decorators. Its uses are so various that it is becoming very general for works requiring lightness and rapidity. It is fast superseding carton-pierre and papier-mâché. It is not only lighter and tougher than either, but it also can be made in larger sections, and adapted to more purposes. Fibrous plaster was used in the Paris Exhibition of 1878 for the construction of the ceilings in the principal edifice of the Exhibition. Some of the panels were nearly 40 feet square. The panels, with the enrichments, were composed of fibrous plaster, but tow was used instead of canvas or trellis cloth. In France it is known by the name of "*staff*," and the enrichments in their frames as *chassis-en-staff*. The "Street of Nations," as well as the large arches in the permanent buildings of the Exhibition, were composed of this material. In the South Kensington Museum there is a large figure of Moses, taken from the marble original in the Church of San Pietro in Vincoli, Rome, executed 1541-53, by Michael Angelo. The cast was made by the Desachy process, and weighs only 168 lbs. The ornamental plaster work of the new Opera House in Paris has been made in *staff*. Fibrous plaster affords great facilities for the faithful reproduction of ancient or modern architectural or other works, either for temporary or permanent purposes. I have used it for stage properties, notably for the column capitals in the Ducal Palace scene, when Miss Marie Wilton produced "The Merchant of Venice" at the old Prince of Wales' Theatre. The caps for perspective purposes ranged from 3 feet to 4 feet 6 inches in height. The bells and the abacus and necking mouldings were composed of fibrous plaster, and the enrichments modelled in plaster

* See Saracenic Plaster Work, Chapter XVI.

† See Fresco, Chapter VII.

and tow. I used a similar process for scenic properties for the late C. Rice at the Royal Theatre, Bradford. I used a combination of tow and canvas fibrous plaster (with iron wire instead of wood laths) for the ornamental parts of various built scenes; also a fountain and other properties for Mr H. E. Abbey, when Miss Mary Anderson appeared as "Juliet," in 1884, at the Lyceum, London. Fibrous plaster has been successfully adapted for construction and decoration. I used this material for constructing facsimiles of the temples of Saturn and Vespasian that stood near the Roman Forum in the grounds of the Italian Exhibition, London, 1888. The temple of Saturn, with its eight remaining columns and the entablature, was 33 feet high. The temple of Vespasian, with its three remaining columns and cornice, was 38 feet high. They were constructed from measured drawings by Mr T. W. Cutler, architect. After standing in the open air during the six months that the Exhibition was open, they were taken down, seemingly none the worse for the exposure, and were then sent "on tour" for other exhibitions. I also used plaster and tow for modelling the Italian coat of arms, and a replica of the old Roman shield for the Fine Art Galleries. The whole was made in the shop, and then fixed in position under the superintendence of my then partner, Mr G. M. Jay. It has often been used for triumphal arches in streets for public rejoicings. The decorations and guns of the old "Victory," for the Naval Exhibition, 1891, were faithfully reproduced in this material by G. Jackson & Sons. Ten thousand superficial yards of fibrous plaster were supplied by the Plastic Decoration Company in the reproduction of ancient streets for "Venice in London." The Veronese Company and Marshall & Slade made many thousand yards of ornamental fibrous plaster work for the Indian and other exhibitions at Earl's Court, London. No less than 150,000 superficial yards of fibrous plaster were used in the buildings at the "World's Fair," Chicago.

Besides those more or less temporary purposes, it is extensively used in the decorations of many classes of permanent building, and is sent abroad in large quantities to our own colonies and other countries. Messrs G. Jackson & Sons, the Plastic Decoration Company, C. H. Mabey, and J. Bickley, of London; Cordingley, Greenwood, and Horne, of Yorkshire; Rule, of Sunderland; and T. Jones, of Liverpool, all employ a large staff of skilled workmen in the manufacture of fibrous plaster. Mr A. McGilvray, of Glasgow, executed a vast quantity of elaborate fibrous plaster ceilings and other works for the Glasgow Municipal Buildings. Nearly the whole of the numerous theatres and music-halls which have been built in London and the provinces during the last generation have been decorated with fibrous plaster. This material has also been used for the decorations of ships' saloons, being first introduced into the "City of New York" and her sister s.s. the "City of Paris" by Mr G. T. Robinson, in 1887, and shortly after into the "Majestic" and "Teutonic," after which its use has become common, its lightness and elasticity rendering it very applicable to ship decorations. One of the most striking examples of the utility of fibrous plaster was the buildings erected on the Champ de Mars for the Paris Exhibition in 1889. The Indian Palace, one of the most imposing edifices in the Exhibition, was the only one that was mainly done by English plasterers, and was erected by Messrs Joubert, of King's Road, Chelsea, London. Messrs Joubert found it more profitable to pay English plasterers 10d. per hour, with lodgings and expenses, than to pay Frenchmen 8d. per hour, with no lodgings or expenses. The Palace was about 180 feet in length and 50 feet in width. It was surmounted by a large central dome and fourteen smaller ones, with minarets and towers. It was constructed of wood framework bolted together, and the walls, ceilings, and domes lined with fibrous plaster, solid plaster being employed where necessary. The exterior was also formed with fibrous plaster. All the decorations were taken from original sculptures in the Indian Museum at South Kensington. The building was designed by Mr C. Purdon Clarke, C.I.E.

For centre flowers or other surface decorations, this material is particularly suited. Its great lightness is a decided point in its favour, as it does not tend to pull down the lath and plaster, but when properly screwed up into the joists, or even the laths, it becomes a support to the three-coat plaster ceiling. An ordinary-sized centre flower can be securely fixed with eight or twelve screws, and without disturbing the lime-plastered ceiling, thus avoiding damp, dust, or dirt, as generally caused when fixing solid plaster centre flowers, which require the ceiling to be cut for keying purposes. A well-made fibrous centre flower, 2 feet in diameter, only weighs about 4 lbs. Therefore it would now be possible to send a centre flower by parcels post!

RENOVATING OLD CEILINGS.—Where old or cracked ceilings require renovations, fibrous plaster is admirably adapted. Old ceilings, whether plain, ornamental, or panelled, can be re-covered without taking down the old plaster. A measured plan of the ceiling is accurately taken, also the projections and profile of the main cornice and ceiling, or beam mouldings, as the case may be. From these measurements and profiles, a new design, or the old one, is arranged to cover the old mouldings and ceiling surface, using the old work as a working base and fixing points. The old work should be probed in places with a fine bradawl, to ascertain the positions of the joists and cornice brackets. These positions are marked on the drawings and corresponding laths, for fixing purposes, and are laid in the new work while being made. The work is made in suitable sized sections, with the joints at the strongest and least noticeable parts. The design can, in many cases, be so arranged that the joints are covered with small mouldings, and screw holes with *patere*. Joints can also be made in the centre of the bed of enrichments, which is afterwards covered with the enrichment. Fibrous plaster enrichments being made in lengths, and fixed dry with fine nails, there is no damp or dust. The above precautions for the joints are especially requisite for work that has to be painted before being fixed. The joints in ordinary work can be stopped with gauged plaster or Parian cement in the usual way. The work is made in the plasterer's workshop, and when dry, it is screwed on to the old plaster work without disturbing the contents of the room, or causing damp or dirt. The ceilings can also be painted and gilded before being fixed, if required.

FIBROUS PLASTER FOR PANELLED CEILINGS.—Fibrous plaster is now largely used for panelled ceilings. Elaborate ceilings with mouldings and enrichments are cast in large sections, and screwed on the joists, thus dispensing with the ordinary lath and plaster. "Finished face slabs" are also used in a similar way, and the joints covered with fibrous mouldings or ribs, forming a plain panelled ceiling at a small cost. This method may also be used for covering and enriching plain or old ceilings without disturbing the existing lath and plaster. Fibrous plaster is now extensively used for casing wood or iron beams and girders; the casing, plain or enriched, can be made the entire length of the beams, thus avoiding joints. Fibrous plaster is also used in a similar way for casing columns and pilasters. Columns are made in two vertical halves, and screwed together over the iron or brick core, and then the joints are stopped.

It will be seen that fibrous plaster can be adopted for many purposes, and that its uses are unlimited for plain and decorative plastic work. It is also a good and ready substitute for wood casing, and decorating rough or constructional surfaces. Fibrous plaster being made in the shop, and dried before being fixed in the building, the work is not delayed by frost or inclement weather. This is a decided advantage where time is a principal consideration. Fibrous plaster will never entirely supplant the old-fashioned lath and plaster or "solid work," as it is termed in the trade, but its utility for many purposes and places is fully demonstrated by the fact that its employment is rapidly increasing, and that it is now specified by many of the leading architects

for plastic decorations in palaces, mansions, clubs, and other buildings throughout the three kingdoms.

From some cause or other, probably the apathy or inability of London master plasterers, and the slight encouragement given by them to apprentices and modellers, many extensive works in fibrous plaster have been secured by carvers (notably Gilbert Seale, a London modeller and carver), who can interpret by their ready pencils the distinctive character of every style, and furnish architects with appropriate and clever decorative designs. Some of the leading specialists in plaster decoration—Jackson & Son and Mabey of London, McGilvray and Ferris of Glasgow, and others, have, however, somewhat turned the tables on these outside rivals in the trade by executing the finest artistic work, not only in plaster, but in stone, wood, and metal. Several of the principal London builders, Cubitt, Bywater, Trollope & Sons, Higgs & Hill, &c., also decorators and art furnishers, Waring & Gillow, F. De Jong & Co., Maple & Co., V. & G. Jelley, Barker & Co. of London, Marsh, Jones, & Cribb of Leeds, and others, manufacture their own fibrous plaster work. It is the bounden duty of all classes of plasterers to encourage the apprentices in the study and practice of designing and modelling, because it is safe to prophesy a great future for decorative fibrous plaster work.

FIBROUS PLASTER NOMENCLATURE.—In consequence of fibrous plaster work and its offspring "reverse-moulding" being comparatively new branches of the plasterer's craft, and not being in general use, a great want of regular terms has arisen. This neglect is partly owing to the carelessness or indifference of those whose interest ceases with the close of the day, and partly to others whose interests are concerned in keeping the process for their own particular use. Some of the existing terms are confusing, and are apt to be mistaken for those used in the more familiar branches of the trade. It is therefore imperative for perspicuity in this description, and for future reference and identification, that each part and process should be definitely named. Existing names that are not conflicting will be retained. Terms for unnamed parts, and new names for old ones, will be given with due regard to applicability and brevity. These will be readily understood by the present proficient workers in fibrous plaster.

FIBROUS PLASTER MATERIALS.—The materials for general fibrous plaster work are plaster, canvas, size, and wood laths. Wire netting, galvanised iron wire, tow, fibre, sawdust, reeds, slag-wool, wood-wool, Portland cement, slag, coke-breeze, and other aggregates are used for special purposes. These are described under their respective headings. Plaster for this work should be strong and slow setting. Coarse plaster, if strong and not sandy, may be used for some purposes, such as making up edges, also for parts of "fibro slabs." Canvas for fibrous plaster should be strong, coarse, and open-meshed. It should be strong to resist strains and pressure; coarse, so that the plaster will adhere to it; and open, so that the plaster will go freely through the meshes when brushed. The size of the mesh varies from $\frac{1}{16}$ inch to $\frac{1}{2}$ inch, according to the class of work in hand, the small mesh being used for fine or small casts, and the larger mesh for general work. A still coarser and more open kind is used for some kinds of fibro slabs. Canvas for fibrous plaster is generally supplied in the No. 3 quality, and in 52 and 72 inch widths. Canvas is also known by the name of "scrim," and is principally made in Dundee, from specially prepared yarns, to resist the process of decay. The nature of the fibre from which the yarns are made necessitates careful treatment in the preparation previous to spinning. It is chiefly supplied by A. F. Latta & Co., London.

CUTTING CANVAS.—There is quite a knack in cutting canvas. Cutting by scissors is a slow method. It should be unrolled and doubled flat in as many plies as can be conveniently

cut at one draw with a knife. Some men can cut twelve plies at once. It is generally cut on a soft wood board, but it is cleaner cut on a piece of plate-glass which has previously been bedded with plaster in a wood frame. The knife cuts best when sharpened on a rough sandstone. This gives a slight rough or toothed edge, which divides canvas better than a smooth edge. As much canvas should be cut at once as will last for one or more days.

FIBROUS PLASTER LATHS.—These are generally cut from second pine, red-wood, or any old wood not liable to twist or warp. Laths are cut in various lengths and thicknesses, according to size and weight of the work in hand, and are left rough from the saw. To save time and confusion, the various kinds are named and described as required for the various works. Laths are used for strengthening the work, also for fixing purposes.

SIZE WATER.—Size water should be clean to ensure strength, and it is best when made with good glue and clean water. It should be tested by measuring a given quantity with a given quantity of clean water, and then gauging a small amount of plaster to determine whether it sets

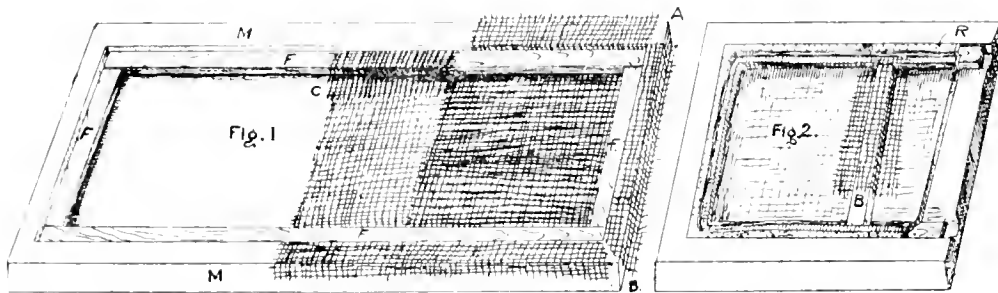

NO. 135.—FIG. 1. PANEL MOULD SHOWING PROCESS OF FILLING IN A FIBROUS PLASTER CAST.
FIG. 2. PORTION OF MOULD WITH CAST NEARLY FINISHED.

too quick or too slow. Suitable measures should be kept ready for measuring both waters. Cream of tartar is also used to retard the setting of plaster.

FIBROUS PLASTER CASTING.—The process of casting fibrous plaster work, although simple, requires care and method in manipulation. Attention must be given to the gauging of the plaster, and the time of setting noted. Never begin gauging until all the necessary canvas and laths are cut to the required sizes. Where there are different sizes, place each in a separate place to save time and confusion. Put away the cut canvas in a handy place where it will be free from dust and plaster splashes. Always cut more of each kind than is actually required for a day's work, to allow for any unforeseen accidents. The size water should be tested and timed. The annexed sketch No. 135, Fig. 1 shows the mould of a plain panel with the laths and a part of the canvas in position. The panel is 3 feet long, 1 foot wide, and 1 inch thick, with a plain band 2 inches wide and curved to the centre surface. M and M are the top and side of the rim of the mould. The mould's rims are the ruling-off edges. The F's are the side and end laths, which are $1\frac{1}{2}$ inches wide and $\frac{1}{4}$ inch thick. The side laths are 2 feet $11\frac{1}{2}$ inches long, and the end laths $8\frac{1}{2}$ inches long. This allows for a $\frac{1}{4}$ inch space at each side and end for plaster and canvas. The canvas is cut into sheets 3 feet 8 inches long and 1 foot 8 inches wide, which allows for a margin 4 inches wide at the sides and ends to be turned back over the laths and on to the surface, as shown by a portion at C. This margin when turned over strains a part of the surface canvas and binds the laths together. Two sheets of canvas are used for good work. It sometimes happens that the outside thickness of the cast is too thin to allow of two sheets to be turned over. In this case the second

sheet is cut to the size of the cast, with just a sufficient margin to cover the outer sides of the laths. Care must be taken to so cut the canvas at the external angles that it can be laid flat without increasing the thickness at the angles. This extra overlapping may be avoided by cutting a piece equal in size to the margin out of each angle, as shown at A. The small square pieces that are cut out of the angles are useful for covering lath joints and a variety of other purposes. If space permits, the angles of the canvas may be cut diagonally as shown at B. The first lot of canvas and laths should be tried temporarily in the mould to test their sizes and positions. The mould is then oiled, and as much plaster gauged—but without size water—as will cover the surface of the mould barely $\frac{1}{8}$ inch thick. This gauge is called “firsts,” and is brushed over the mould to expel the air. The next coat is called “seconds,” and is gauged with size water to give time to lay and brush the canvas before the plaster sets. The two gauges should be done at one time, so that the “firsts” will not be set before the “seconds” can be applied. When the “firsts” is slightly firm, or “tacky,” a small portion of “seconds” is poured on, and lightly brushed over the “firsts,” so as to bind the two coats together, but without disturbing the thickness of the “firsts.” For delicate work, the “seconds” is gently splashed on with a tool brush. This tends to bind the two coats with less brushing.

Great care must be taken that the “firsts” is not set before the “seconds” is put on and brushed; also that the “seconds” is not set when the first sheet of canvas is put on. This is one of the secrets of success in casting fibrous plaster, because if the two coats of plaster are not properly incorporated, the “firsts” will be left in the mould, and if the canvas is not properly worked and brushed into the “seconds,” both will be left in the mould, and the cast will be useless. Having laid and brushed the two coats, the first sheet of canvas is laid—allowing the margin to lie over the rim of the mould; pressing it down into the angles at the sides and ends, also into sunk parts of the mould with the fingers, beginning in the middle of the canvas piece, so as to work out the air and prevent creases. Then using the fingers of the left hand for pressing the canvas more accurately into the hollows, take in the right hand a gauge brush and dip it into the gauge-pot containing the “seconds,” and brush all over the canvas until the surface plaster and the canvas is well knit together. The second sheet is now laid in a similar way, care being taken that the first is in a moist state. If dry, brush it over with “seconds” to give a better binding key for the new sheet. It may here be noted that if the size or shape of the mould necessitates several pieces of canvas to cover the surface, each piece should be laid to lap about 2 inches over the joints of the previous one, and the joints of the second coat of canvas should be made in the same way, and at the centre of the first coat pieces. This method of lapping and breaking the joints makes the cast stronger, thinner, and more uniform. It will be understood that the canvas margin that lies on the mould rim is left unbrushed with plaster until the laths are laid. The laths are dipped in or brushed over with “seconds,” and laid in position, the bed of each being previously brushed with “seconds” to give a solid bed. The canvas margin is now turned back over the laths, following the form of the lath, and then well pressed and brushed into all angles. Turn over one side and sheet at a time, and fold the external angles closely together. When all the margins are finished, stiffen a little “seconds” with dry plaster, and make up the edge of the cast until flush with the mould rim, as shown at R (Fig. 2). These edges are made from $\frac{1}{2}$ inch to 1 inch wide, and ruled fair with the mould rims, so as to leave a smooth edge and a true bearing for fixing purposes. Casts with extra thick edges or rims are strengthened by placing the rim laths on edge, or by using two thicknesses of laths and canvassing and brushing. Thick edges are also made up with strips of canvas dipped in plaster and brushed in position. A strong way is to make the edges up with tow

and plaster. Care should be taken that all canvas margins are turned back over the rim laths or on itself to strengthen the edge before the plaster sets, because if set, the canvas cannot be turned over so freely or made to fit so close to the laths or angles. It is also apt to lift the plaster from the face of the mould. It sometimes happens that the canvas and plaster get above the level of the rim. In this case it can be cut down flush with the rim with a sharp knife after the stuff is set.

Fig. 2 shows a portion of the mould and sections of the cast, side laths, and made-up sides or rim of the cast. B is a "body lath" with a portion of a canvas strip unbrushed. Body laths are used to strengthen large casts. Canvas strips should be cut sufficiently wide to cover the laths and about 2 inches on each side. When filling in large casts, there may be more than one gauge of "seconds" required. A small part of each gauge should be put aside as a guide to know when the under coats are set, because the cast must not be taken out till all is set. If the setting is properly timed by the size water, this precaution is unnecessary. Fibrous casts being strong and flexible, and containing a small body thickness of plaster, there is little or no expansion, therefore the casts are much more easily released from the mould than "solid" casts. The terms "brush" or "to brush" means to brush the laths or canvas with "seconds." It is then termed "brushed." The making of all classes of fibrous plaster is based on the foregoing method, but as a further aid to the novice, the method of making ornamental works in fibrous plaster is given hereafter.

TO CAST A FIBROUS PLASTER CENTRE FLOWER.—The annexed sketch (No. 136) elucidates the method of casting a fibrous centre flower in a wax mould. This centre flower is 3 feet in diameter. A portion of the plan, with section, is shown in Fig. 1. Take this section to distinguish the various parts of the centre flower. A is the body, B the border, C the centre, and D the seed, or drop. In the old way for "solid work" the border is cast separately in short lengths, but for fibrous work the whole of the border is cast with the body. It will be seen that the centre is cast separately. A bed, as shown on the section, is made on the body to act as a fixing point for the centre. This method saves a considerable quantity of wax when moulding, especially if the centre has a deep projection. It also gives greater freedom for handling the original when moulding, and the mould and cast when casting. The seed is also moulded separately for two reasons—first, because it is often dispensed with when a metal rose is used with the gasfittings; and second, to allow the centre to be moulded in one piece.

Fig. 2 shows a portion of the wax mould of the body with a portion of the canvas, and plaster and laths in position. A and O are the inner and outer rims of the mould. E and F are the inner and outer rim laths respectively. The rim laths are $1\frac{3}{4}$ inches wide, $\frac{1}{4}$ inch thick, and as long as can be cut out of a deal board. The outside radius should be $\frac{1}{2}$ inch less than the mould rims, to allow a space for the plaster and the canvas to be turned up and over the laths. There must be sufficient rim laths cut to complete the circles, also extra pieces to overlap or break the joints if required. The joints need not butt accurately, any little inequality being made up with plaster and canvas, or, if space permits, covered with overlapping pieces. Splay joints, as shown at F, are stronger than square ones. R is the plan of a rib lath. Four are used and placed at right angles to each other. Large flowers, or those with deep sections, require six, eight, and even ten ribs to strengthen them. The ribs for this size of flower are $\frac{3}{8}$ inch thick, but ribs up to 1 inch are used for larger ones. Ribs $\frac{1}{2}$ inch thick are used for smaller and thinner flowers than the above. The outer rim lath for this one is cut to a radius that will give the most depth, to allow the ribs and the "point laths" to overlap. Should the depth not allow the laths to overlap, they are cut to fit between the rim lath and the rim of the moulding, as shown by the two laths at G. These two "point laths" strengthen the outer edges, also the points of the cast. Where space permits, "point

laths" may be used to lay over or under the rim laths, as shown at P and P'. The latter way will be found useful for strengthening narrow or long points in a cast.

Fig. 3 shows the section of one-half of the mould. SR is the section of the rib laths; SE, S'I, and SP are the sections of the inner and outer rim laths and the point laths respectively. The canvas should be cut in eight radiating pieces, allowing for a 2-inch overlap at each side, and a 4-inch margin beyond the outer and inner rim laths. A quantity of short pieces of canvas are required to fit the border, as shown at H. The border pieces are cut to take the general outline of the border. It is not necessary that the pieces should be cut accurately to fit all the curves. If the edges are deep, leave a margin to be turned over; and if thick, turn over straggling edges, making up any little parts with small pieces of canvas. Galvanised iron wire, bent to the contour of the outer line of the cast, is sometimes used to strengthen thin or tender parts of casts. Having cut sufficient laths and canvas, and oiled and washed the mould out, the "firsts" is gauged and carefully brushed into all the sunk parts, and then the "seconds" brushed or splashed as before. The border pieces

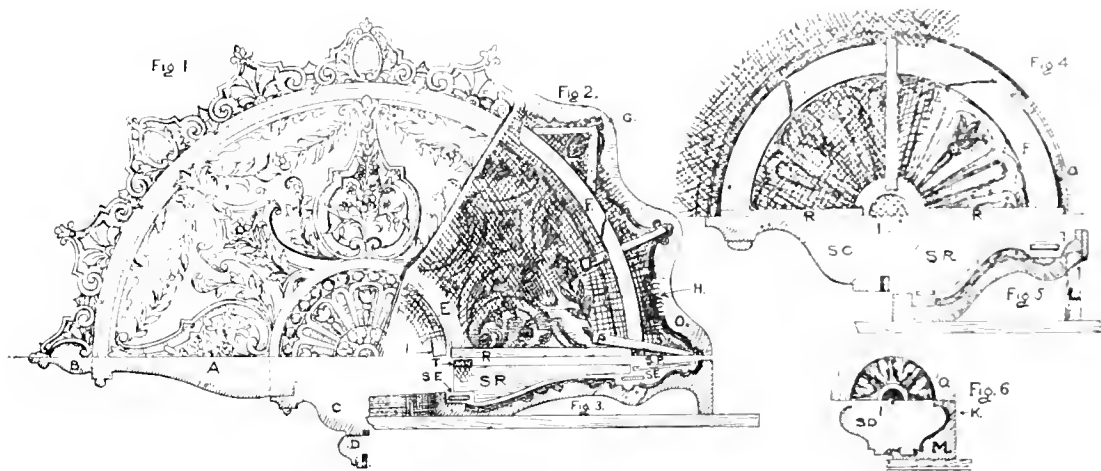

No. 136.—CASTING A FIBROUS PLASTER CENTRE FLOWER.

Fig. 1.—Part Plan, with Section of Centre Flower. Fig. 2.—Part of Wax Mould with Cast partly filled in.—Fig. 3.—Section of Body Mould and Cast. Fig. 4.—Half Plan and Section of Centre. Fig. 5.—Section of Centre Mould and Cast. Fig. 6.—Half Plan and Section of Seed Mould.

of canvas are laid first, brushed and pressed into the angles of the outline of the border, making up any uncovered parts with small pieces. This is repeated until the whole circle of the border is completed. The radiating pieces for the body are next laid, putting down one at a time, and so as to overlap each other, leaving the margin at the inner rim and the margin outside the line of the outer rim laths unbrushed. After all those pieces are laid and brushed, the outer and inner rim laths are laid in position, taking care to brush them and their beds as before. The margins are next turned over and brushed. The four rib laths are next laid, and covered with canvas strips, and brushed. The point laths are next laid, canvased, and brushed, and then the outer rim made up and ruled off flush with the outer rim. Plaster and canvas, or tow dots are formed on the inner top edges of the rib laths (as shown at T, and ruled flush with the outer mould rim. These dots prevent the cast from drooping in the centre while drying, and also form resisting points, to keep the centre of flower true when being screwed up. Should the overlapping of the radiating pieces and the small pieces of canvas, which are sometimes used for filling in extra deep parts in the

mould, not complete two coats of canvas, the deficiencies are made up with small pieces, and brushed. The whole surface is then brushed with "seconds," to bind all margins, and give the whole surface a more finished appearance. The mould is now placed in warm water until it becomes warm and pliable, when it is taken out and eased round the rim, and the cast gently pulled out. When using large wax moulds which cannot be conveniently put in a hot-water tank, they may be made pliable by pouring hot water over the back of the cast, also by using hot-water cloths made of old sacks or canvas.

Fig. 4 shows an enlarged plan of one-half of wax mould for the centre, with a part of the plaster, canvas, and laths in position. I and O are the inner and outer mould rims respectively. E and F are the inner and outer rim laths. The R's show the plan of three of the four rib laths. sC is the section of the cast.

Fig. 5 shows a section of one-half of the mould. L is one of four legs which are placed at equal distances apart in the liquid wax, and flush with the top. When the wax is firm on the top surface of the mould, it is "bled" by cutting a hole in the side, and allowing the interior liquid wax to run out into the wax-pot, then pressing the top skin down, thus leaving the mould nearly uniform in thickness, and the legs as supports to carry the outer rim. This allows for the wax which has run out to be used for other purposes. The mould is also more pliable than if solid. The section of the inner and outer laths will be seen under sR, which is the section of the rib laths. The dotted line indicates the outline of the perforated flutes. The first coat of canvas for this mould is cut in four radiating pieces, with margins as shown over the inner and outer mould rims. The second coat is cut to the same size, if space permits, for the second thickness of margin; but if the cast is thin at the outer edge, then the second coat is cut to fit the surface of the mould at the outside. It will be understood that a margin is left for the inner rim, where the thickness of the cast is not confined to any particular measure. The canvas is laid as before, breaking the joints, and covering all the surface, including the perforated flutes. The rim laths are laid, and then the margins are turned over and brushed. The four ribs are next placed in position and brushed, and the rim made up and ruled off as before. When the cast is set, the canvas and plaster which covers the perforated flutes are cut off flush with the wax, and ragged edges made smooth by brushing. When making originals for perforated work, the sinking should only be about $\frac{1}{4}$ inch deep. If deeper than this, the edges at the perforations of the cast stand up from the surface line, and are more liable to get broken or bent. Where the perforations are large, it is usual to lay and brush canvas strips around, and flush with the projecting parts in the mould which form the perforations.

Fig. 6, shows a plan of one-half of the seed mould. I and O are the inner and outer rims respectively. The inner rim forms the hole for the gas-pipe. sD is the section of the cast. M is the section of the mould. This mould has two parts (a front and back), with the joint at K. As this is too small to admit of laths, canvas, or, better still, tow soaked in plaster, will make the cast sufficiently strong. The inner outline of the cast is denoted by a dotted line. This leaves a shouldered part at the top, which forms a key for fixing on to the centre. The seed is best fixed with tow and plaster. If there are any plantings to fix, trimming or stopping required, it should be done while the casts are green. Centre flowers or other flat work while surface drying should be laid flat to prevent them from twisting. When the external dampness has gone off the cast's surface, it is usual to lay them in an oven or a drying-room to accelerate the drying. Canvas sometimes shows on surface parts of new casts. These canvas patches (if not too rough) will dry out, and will be scarcely perceptible when the cast is dry. Canvas patches are caused by the

"firstings" being unequal in thickness, also by soft gauging. Mouldings, or other parts that require smoothing, are rubbed with fine glass paper after the casts are dry.

UNDERCUTTING FIBROUS PLASTER.—It is often desirable to undercut some parts, such as fruit, flowers, and foliage, which have been stopped down on the original to allow a wax mould to draw, and as fibrous plaster is thin, and difficult to cut clean, it is necessary to make a provision for this. This is done by first stiffening a portion of "seconds" with dry plaster, and then working it with a small tool round the proposed undercut parts in the mould, and before this is set the mould is filled in as before. If the undercut parts in the original are large, it is best to make plaster pieces at the parts before the mould is made. The small seams caused by the joints at the plaster pieces are easily taken off with a small tool or a fine file. Undercutting by hand is the best way for small parts. The work is more varied and artistic in appearance when done by hand.

FIBROUS PLASTER CORNICES.—Mouldings of any reasonable length may be made in fibrous plaster, but they are generally made in 10 to 18 feet lengths, or in such sizes that two or three casts will make up the length of an ordinary-sized room. For example, if a room is 33 feet by 20 feet, the mould would be made 13 feet long, out of which would be cast three 11-foot pieces to make up the full lengths of one side, and two 10-foot lengths for one end of the room, the other side and end being made up the same way. Short pieces for breaks or other parts are cast out of the same mould. The mould is made longer than the longest cast required, to allow for a bed for the "mitre stops" that are used for forming internal and external mitres, and also for square butt joints on the casts, hence the reason for the above mould being 13 feet. The extra length of mould is regulated by the projection of the cornice. Fibrous plaster cornices are often cast in "reverse moulds." This useful part of plastic art should be mastered before attempting the casting of fibrous plaster work. A quick way of producing fibrous plaster enriched cornices is by the use of jelly moulds. A moulding-piece is first made by running a length of moulding on a bench, then fixing the enrichments, keeping both ends jointed. The model is then cased, moulded, and the casts made.

MITRE AND JOINT STOPS.—Mitre stops being required before the cornice cast is made, the method of making them is given first. Mitre stops are made of plaster, and are used as fences to form mitres and joints in cornices, &c. They are laid on the casting mould, and being movable, any desired length of cornice (less than the length of the mould) can be made, and each length with any desired form of mitre or joint at both ends of the cast.

Fig. 2, in illustration No. 137, elucidates the method of making mitre and square joint stops. This also shows the section of a reverse casting mould for a plain cornice, having a projection about $7\frac{1}{2}$ inches and a depth of $7\frac{1}{2}$ inches, with sections of the laths used for the cornice cast. LHE is a left-hand external mitre stop; LHI is a left-hand internal mitre stop; and s is a square joint or butt stop. The right-hand mitres are, of course, cut to the opposite angles. Mitre stops are made by first covering a sufficient length of the casting mould with damp paper, laid to the contour of the mouldings. The paper allows the plaster piece to leave the mould freely, and prevents chipping. Gauged plaster is then laid on the papered surface to the desired thickness, and ruled square with the mould rims. If wood rules are laid flat on the rims to act as fences, no ruling off is required. The plaster (for small mouldings) is made up to the square of the rim lines, so that the mitre stops will act as ruling-off bearings, or points for proving the square of the cast when being filled in. When mitre stops are not made up to the square, boards cut to the square are fixed at the mitre stops as guides for testing the squareness of the casts. This is only necessary where the space between the mould's surface and the square of the rims will only admit of the laths and a sufficient thickness of plaster and canvas, which makes up the cast nearly to the square of the rims, as shown

by the sections and the dotted lines in Figs. 3, 4, and 5. Where there is ample space, and the laths well within the square, as shown in Fig. 2, a thickness from 2 to 3 inches will give sufficient strength for the stops and width of bearing for ruling off or testing the square of the cast. After the plaster piece is taken off, the various lengths of the stops are set out and sawn to the required angles. The mitres are best sawn in a mitre box. Each stop should be lettered, to save confusion. All measurements for stops and cornices should be taken from the wall line. If the cornice is large, or has acute angles, or is difficult to draw in places, the stops must be made in two or more longitudinal sections.

CASTING FIBROUS PLASTER PLAIN CORNICES.—Illustration No. 137 also elucidates the method of casting plain cornices having various profiles. Fig. 1 shows a reverse casting mould (in plaster, on a running board, with the plaster, canvas, and laths in position. This cornice has a ceiling projection of 12 inches, and a wall depth of 10½ inches. RB is the running board or bench; s is the section of the casting mould, the dotted part being the plaster; CR is the "ceiling rim";

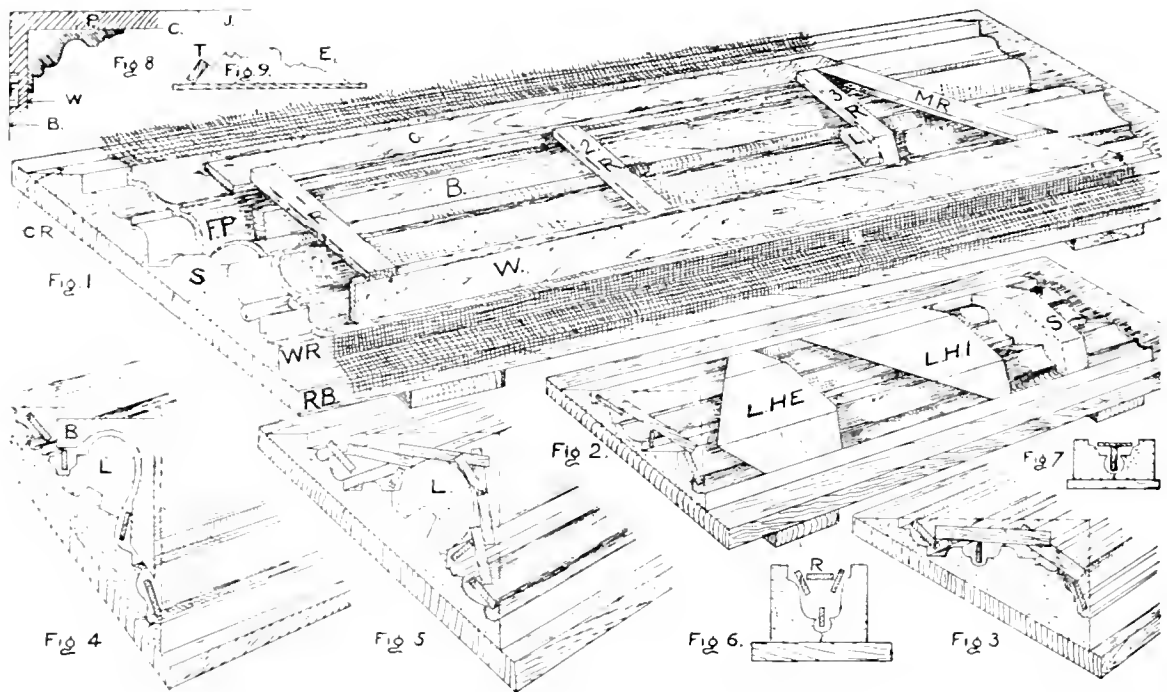

NO. 137.—CASTING FIBROUS PLASTER PLAIN CORNICES.

and WR is the "wall rim" of the mould. These rims are also known as the "striking-off edges" of the mould. They represent the ceiling and wall lines. No laths, canvas, or plaster must protrude beyond the square of these lines. The square of the ceiling and wall lines is indicated by the dotted lines on Figs. 2, 3, 4, and 5. The ceiling and wall lines are horizontal and perpendicular respectively. FP is the first coat of plaster and canvas brushed together. The unbrushed canvas margin lies over the mould rims and on the board, ready to be turned over when the ceiling and wall laths are laid in position. The various laths, before being canvased and brushed, are also shown in position. C is the "ceiling lath"; W is the "wall lath"; and B is a "body lath." The ceiling and wall laths are about 2 inches wide, $\frac{1}{4}$ inch thick, and in lengths according to the cast. Thicker and wider laths are required for larger cornices. The body lath is about 2 inches wide, and $\frac{3}{4}$ inch thick. The extra thickness is to enable the lath to better carry the weight of the cornice until fixed; two or more

ceiling or wall laths may be used to make up the desired thickness of a centre body lath. Two or more body laths are required for larger cornices; the centre, or main lath, should be placed on edge and near the centre of the cast, or at a prominent square member, as shown at B. This secures the utmost available strength for the cast generally, and also strengthens the part which next to the ceiling and wall parts, is most frequently handled while being fixed. The R's, 1, 2, and 3, are "rib laths." No. 1 laps over the ceiling and wall laths, and No. 2 butts against them, thus forming a lap and butt joint alternately, which gives greater strength than if laid all one way. It sometimes happens that space will not permit for overlapping joints, butt joints are then compulsory; but if the laths are rough, and the canvas well and closely laid and brushed, there is no fear of the joints coming asunder, especially for small cornices or where there is no great weight or strain. It requires a considerable amount of force to pull a well-brushed piece of canvas off a rough lath. No. 3 shows a rib lath in two pieces. This plan is adopted when the angle of the cornice will not permit of a single straight lath. The joint is strengthened by means of a "lap lath," L. In order to show the method of making a joint in rib laths where ceiling, wall, or angle space is limited, this lap lath is placed against the joint; but where space or angle permits, a stronger joint is obtained by placing it over the joint. MR is a "mitre lath." It is placed at the desired angle to strengthen the mitre. Rib laths are placed from 2 to 5 feet apart, according to the strength requisite to support the moulding being cast. Rib laths take the place of cornice brackets, and connect the ceiling and wall laths, and prevent the moulding collapsing. Thin laths laid flat are sometimes required to strengthen the splayed edges of mitres. In order to show the position of the mitre laths more clearly, the "mitre stop" is omitted.

Having seasoned the mould and stops with shellac, the length of the proposed cast of moulding is now set out on the mould, the stops fixed with clay, and the whole surface oiled. A sufficient quantity of laths and canvas is cut and laid in a convenient place, keeping each kind and size in a separate place to save time and confusion. Two sheets of canvas are cut to the length and width of the mould, allowing for an overlapping margin at the ceiling and wall laths as shown, where it lies over the mould rims. The length of the canvas is best taken with a rod, and the width with a string, laid on the mould so as to follow the contour of the mouldings. An ample quantity of long and short canvas strips to cover the body and rib laths, also a number of small pieces to cover lap and butt joints, are necessary. The "firsts" and "seconds" are gauged and laid as previously described, and then the first sheet of body canvas is laid and brushed. Each sheet is laid so as to follow the contour of the mould, and leave an equal margin at the mould rims. Commence the pressing and brushing from the centre of the mould, and work outwards all ways. The second sheet is laid in a similar way. The ceiling and wall laths are then laid in position, keeping them close to the mould's rims, so as to strengthen the outside edges of the cast. They should also be laid so as to give the strongest and best position for screwing through when the cast is being fixed. The margins—one at a time—are then turned over, pressed into the longitudinal angles, and brushed. The body laths are next laid, taking care that their positions will give the best available strength. This is regulated by the form and size of the mould, but where practicable all laths should be laid flat and on edge alternately, which gives the greatest resisting force to strains and weights.

When the body laths are covered with canvas strips, the rib and mitre laths are laid, canvased, and brushed, taking care that all lath joints are covered with extra strips and well brushed. The rims of the cast or bearing parts at the ceiling and wall lines are next made up, and ruled off flush with the mould rims. When the laths can be got close to and nearly flush with the mould rims the canvas and plaster alone will make up the cast rims. When all is set, the stops are removed, and the

cast eased at the ends, and then taken out and placed on a straight board to dry. Should the cast warp slightly, it can be screwed straight when being fixed. Warping is caused by using bad timber for the laths, also by too rapid or unequal drying. If warping is excessive, or shows as soon as the cast is taken out, it should be weighted down, or screwed to a straight board while green, and left until dry.

Fig. 3 shows the section of a reverse casting mould for a plain cornice, having a projection of 1 foot and a depth of 6 inches. The positions and sections of the ceiling, wall, body, and rib laths are all shown. The various laths will be known by their positions, as already described. As a further distinction, the rib laths in Figs. 2, 3, 4, and 5 are shown by the greater thickness, which is about double to that of the longitudinal laths.

Fig. 4 shows the section of a reverse mould for a cornice, having a projection of 9 inches and a depth of 15 inches. Two body laths, as shown, are required for this size and form of moulding. Brackets are in some instances used in place of rib laths for coves or other curved work, such as the "ogee cove," shown in this section of mould. Brackets should be cut to overlap or butt as near as possible to the longitudinal laths, as shown by the bracket B. Large brackets are made up in two or more pieces of timber, similar to long templates, as shown for Gothic mouldings. Brackets are seldom used for general work. Small curves can be made up with short laths, as shown in Fig. 5. L is a loose piece in the mould, which is requisite in this section for drawing purposes. It will be seen that the loose piece is made with a keyed or rebated joint. This keeps it in position, and prevents it shifting while the cast is being filled in.

Fig. 5 shows the section of a reverse mould for a cornice, having a projection of 12 inches and a depth of 12 inches. This profile of cornice also requires a loose piece, as shown at L. Section of the laths is also shown. As already stated, the curve of the cove is made up with short laths. It is unnecessary to use as many pieces as shown for this size of a cove. This form is only given to illustrate the general method for forming curved ribs where brackets are not obtainable.

Fig. 6 shows the section of a rib moulding (4 inches wide by 4½ inches deep), and the laths. R is a rib lath, placed from 3 to 4 feet apart. Two longitudinal laths only are used for small mouldings. The laths are placed in the form of a T, as shown at Fig. 7. The top lath is used for fixing purposes. It also takes the place of rib laths.

Fig. 8 shows the section of a cornice, having a small projection or thickness at the ceiling and wall members. This is given to illustrate the methods for gaining increased space, so as to allow for a requisite thickness of ceiling and wall laths, where the members are too thin to admit of same. The method may also be used where an increased thickness of laths is required, so as to give increased strength for large or heavy work. Reference to the sketch will assist the explanation of the methods. B is the brick (or other constructional) wall line, and J is the joist line; P is lime plaster, and F is the section of a wood fillet used for fixing purposes; C is the finished ceiling line; and W is the finished wall line. The desired extra space is obtained by extending the outer lines of the ceiling and wall members, as shown by the dotted line at E in Fig. 9, which is a section of the casting mould. This is done when setting out the reverse running mould. Another way is used where the casting mould is already made, and is done by laying a thickness rule on the mould rims, as shown at T on Fig. 9. The extra space must not extend beyond the brick wall and joist lines. All sketches of fibrous cornices herein given are taken from the finished ceiling and wall lines, and in each case there is sufficient space for all laths. This hint will be found useful when setting out full-sized mouldings and reverse running moulds for fibrous plaster work.

CASTING FIBROUS PLASTER ENRICHED CORNICES: BEDDED ENRICHMENT SYSTEM.—These

enriched cornices are best cast in reverse plaster moulds. This method is expeditious, and produces accurate and clean work. There are three systems for forming the enrichments in enriched cornices, viz., "bedded," "fixed," and "cast." Each system has some individual merit, which may be of advantage for special purposes. For the bedded system the fibrous enrichments are cast in long pieces. They are then bedded face downwards in the reverse cornice mould, taking care that they are accurately jointed and mitred. The whole surface of the mould and the backs of the enrichments are canvased and brushed, as described for plain cornices, thus forming the plain and enriched members in one body. As the face of the casts are downwards, and cannot be seen in the mould, it requires considerable skill and memory to correctly joint and mitre the enrichments. This is best done by temporarily placing the casts face upwards so as to see the joints and mitres in position to the desired lengths of cornice, and when the joints and mitres are regulated, the

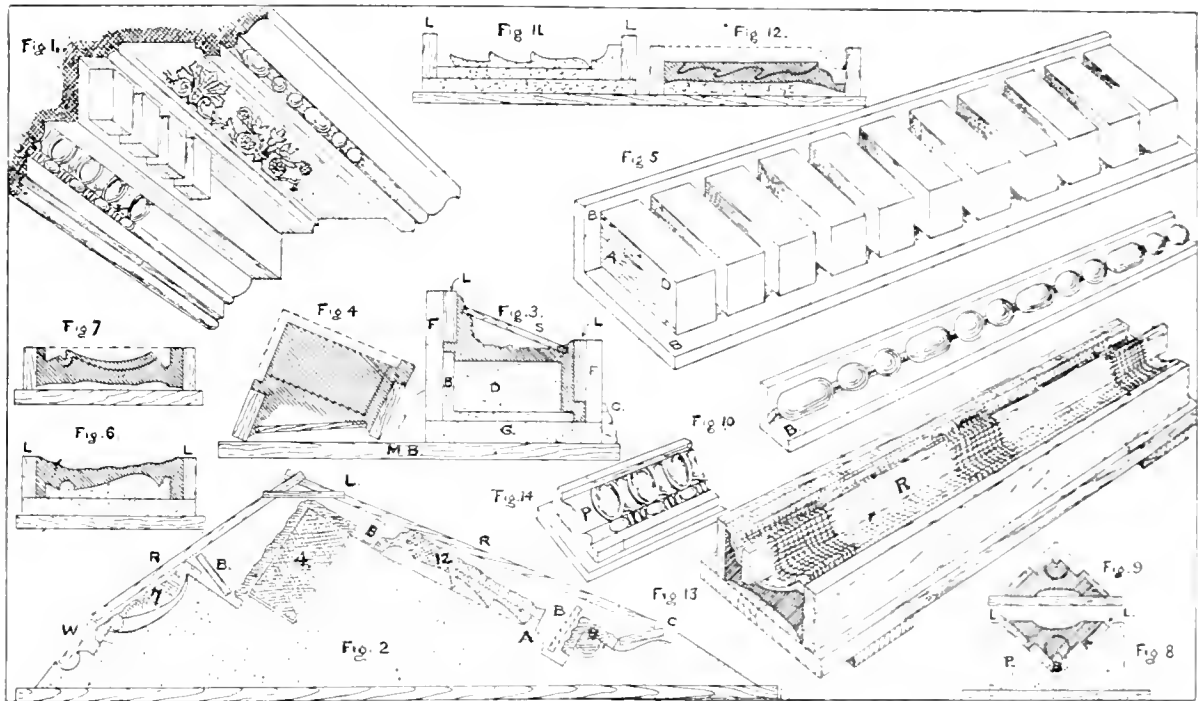

No. 138.—CASTING FIBROUS PLASTER ENRICHED CORNICES BY THE BEDDED ENRICHMENT SYSTEM. REVERSE AND FRAMED WAXED MOULDS FOR ENRICHMENTS.

casts are numbered consecutively, and laid in the cornice mould in their proper positions and rotation. The casts are held in position with plaster dots to prevent them moving while they are being canvased and brushed with the plain members. A bed for each enrichment must be formed when setting out the reverse running mould. The bed in this case is made in the outer section of the cornice, being the reverse of that used for solid work, because the bed has to receive and fit or fit at the most prominent parts—the face section of the casts. This and other parts of the process will be best understood by referring to the illustrations.

The annexed illustration No. 138 elucidates the method of casting enriched cornices in fibrous plaster by the bedded system. This illustration also elucidates the method of "moulding" and "casting" fibrous enrichments, both of which are a part of the work in hand. Fig. 1 shows a section and perspective view of an enriched cornice, having a projection about 1 foot 5 inches and

a depth of 11 inches intended to be constructed in fibrous plaster, and the enrichments to be "bedded." Fig. 2 shows an enlarged section of the reverse casting mould for the above cornice, showing sections of the fibrous enrichments and laths in position. Nos. 4, 7, 12, and 9 are an enriched bead, soffit, dentil, and bed-mould respectively. The section surface is indicated by crossed lines. The numbers in this case are made to correspond with Figs. 4, 7, 12, and 9, which are the casting moulds respectively of the enrichments. The dotted lines on these moulds indicate the back surface of the casts. The back surfaces of the casts in the cornice mould are shown rough or irregular. The reason for this will be seen in the casting of the enrichments. A reverse casting mould for a cornice with bedded enrichments seldom requires loose pieces, because the enrichments act as loose pieces, and tend to free the whole cast from the mould. The enrichments being required before the cornice is cast, their method of casting claims precedence.

After all the enrichments are cast, they are laid in the cornice mould, as shown in Fig. 2. Having arranged the joints and mitres, and fixed the casts with small plaster dots (as already explained), canvas strips are then cut to the length of the cornice mould, and as wide as will cover the plain members between the enrichments, allowing for a margin to lie over the joints and on the enrichments. Two strips are also required to cover the plain member at the ceiling and wall lines, allowing for a margin to be turned over the laths. The long strips are laid and brushed as before, and a second canvas coat is laid in the same way, and the margins at the ceiling and wall lines (C and W) are turned over and brushed. The three body laths (B, B, and B) are next laid, canvased, and brushed; and then the two rib laths (R and R) and the top lath (L) are laid as before. Some men lay the canvas in sheets (as described for plain cornices), placing the canvas over all the plain and enriched members in one sheet, then following with another sheet. This way may be all right for large mouldings and enrichments; still it is an unnecessary waste of canvas, as there will be four canvas coats at the enriched members, besides another coat on some parts, caused by the strip for the body laths. Long canvas strips laid by the first method enables the work to be well brushed without overweighting the enrichments. The two coats of long strips and the lath strips will be found to give ample strength for ordinary-sized cornices, such as Fig. 2. For large work, laths are laid in the cavities of the dentils. The laths extend from the inner face angles to the ceiling part of the rib lath, and then another lath is laid at right angles, and extending to the wall part of rib lath. The dentil laths being connected with the rib laths are of course laid at intervals. To some it may appear that there is a great amount of timber required for fibrous cornices, but the total will not nearly cube to the amount required for the brackets and lath used in solid work for a cornice of equal girth. Judgment is requisite for the proper placing of laths, so as to obtain the greatest possible strength. A lath $1\frac{1}{2}$ inches wide and $\frac{1}{4}$ inch thick, if fixed in the proper place and angle, will afford as much strength as a lath twice the size laid at random. It will be understood that laths laid to connect other laths, such as rib laths, are not made up solid at the intervening spaces between the lath and the cast, but are simply canvased, and only brushed on the laths and on the body of the cast, thus leaving the spaces between the laths and the cast hollow. In many cases canvas strips laid across the ends of the laths, and where they touch the prominent parts of the cast, and then well brushed over, will be sufficient to bind and strengthen the various parts of the work. On pencil or ink drawings it is usual to indicate the inner sections of mouldings for ordinary plaster work by parallel lines. In this and the following sketches I have used crossed lines to indicate fibrous plaster; and I venture to suggest to architects to adopt this method (unless colours are used), so as to distinguish it from the old lime plaster or "solid work." The method of moulding and casting fibrous plaster enrichments for fibrous plaster cornices is as follows:—

MOULDING FOR FIBROUS PLASTER.—Moulds for casting fibrous enrichments are usually made of wax, gelatine being used for undercut work. Moulding pieces are made in lengths from 3 to 5 feet for small work, and from 5 to 7 feet or even 12 feet for large work, but there is no limit to the lengths, as fibrous casts may be got out the full length of the cornice. Moulding pieces are made by casting as many casts of the ordinary size as will make up the required length. They are then fixed on a ground or a profile, according to their sections. For bedded work, a part about $\frac{1}{2}$ inch wide of the plain members at each side is run with the profile bed. The joints must be made so that there will be no trimming or jointing on the casts, because the canvas comes close to the surface and edges, therefore it cannot be trimmed so easily as solid plaster. Fibrous casts are much thinner than solid plaster, so the depth at the sides and joints of the moulding piece need not be so great as for solid work. If the section at the joints is deep or undercut when using wax, make a plaster piece, as shown at P, Fig. 14, on illustration No. 138. This allows the mould and the cast to draw, and forms jointed ends at the casts. This is made as described for a jointed mould in Chapter IX. Long moulds are best made with wood sides and ends. This method strengthens wax moulds, and keeps those of gelatine straight. Fibrous laths, or ordinary running rules, are used, and are let in while the wax is soft, or where practicable they are fixed in a similar position to clay or plaster fences. The wax or gelatine, as the case may be, adheres to the wood fences, thus giving the desired strength. When the moulds are done with, the wood is freed from the mould, and the materials kept for future use. These moulds are termed "framed moulds." Where practicable, the sides and ends of the frame should be nailed together before being placed in position.

Fig. 3 shows the sections of the moulding piece, fences, and wax mould of the dentil on the moulding board MB. G is the ground of the moulding piece, and B is the "backing" which carries the dentils D, forming a "lapping part" of the plain members at the top and bottom of the dentil. The lapping parts also keep the casts in position while being canvased and brushed, and make a better joint than if made at angles, or at the joints of plain and enriched members. The backing and lapping parts will be further understood by comparing B and B on Fig. 5, which is a sectional view of the cast, and then comparing the section No. 4 on Fig. 2. The sections of the plaster moulding pieces on all the figures are indicated by a dotted surface. (This also applies to the plaster fences F and F on Fig. 3. The section surfaces of the wax moulds are shown black. On Fig. 3, L and L are sections of the frame laths, and S is a stay or brace which is placed at intervals to support the mould. The lower frame lath is temporarily fixed to the fence with thick clay water or thin gauged plaster, and then placed in position and secured with clay or plaster dots, as shown at c. The high fence is then fixed in a similar way. After this the wax is poured on until it reaches the level of the low frame, when it is worked up over the side of the high frame, and then the stays put in where required. The wax is worked up by the aid of a gauging trowel. For clay work, use the fingers to draw the wax when near the original, so as not to injure the model. After the wax is set, take the fences off, and then the mould, and lay it on a board as at Fig. 4, which is a section of the mould ready for filling in. The section of the mould on Fig. 3 is taken through a dentil, and the section on Fig. 4 is taken through the division that divides the dentils. Fig. 6 shows a section of the moulding piece and mould of the bed-mould enrichment. This is moulded in a similar way to the dentil, with the exception that plaster fences are not required. The wood laths, or running rules, l and l, which form the frame, also act as fences. Fig. 7 shows the section of casting mould ready for filling in. The section at Fig. 6 is taken through the egg, and the section of Fig. 7 is taken through the spindle of the bead.

and in a line with the egg and the dart. The dark line in the black surface is the profile of the egg, and the line above, or finish of the dark surface, is the profile of sunk part between the egg and the dart. Fig. 8 shows sections of the moulding piece, mould, and frame laths. P is a plaster profile or "bed" to receive the beads. The backing B, and the spindle of the bead (just above the B), are run with the bed. The beads are then fixed over the spindle, the whole thus forming the moulding piece. The backing and lapping parts are also seen at B, which is a sectional view of a cast of the bead. The frame laths L and L are simply laid on the moulding piece, and the wax poured on as before. Fig. 9 shows the section of the bead-mould. This and the section at Fig. 8 is taken through the spindle. The section of the bead in each case is indicated by the dark line in the dark space. Fig. 11 shows the sections of the moulding piece of the soffit, and the frame laths L and L ready for moulding. The enrichment being undercut, it is moulded with gelatine, which is poured on until flush with the top edges of the frame laths. No case is required, hence the term "open jelly mould." If the mould is wide, or thin in parts, the jelly is only run until about 1 inch from the frame edges, and the difference made up with plaster, as shown at Fig. 12, which is a section of the mould. Two ways are shown for forming the bearing and lapping parts of the soffit. The inner side is formed with a plain member, as shown on Figs. 11 and 2. This is necessary, because the foliage on the soffit extends to the plain member, leaving no margin for a bearing or lapping part. On the outer side the foliage does not extend to the plain member, thus leaving a plain margin on the soffit, which is utilised as a bearing and lapping part. A provision for this must be made when setting out the reverse running mould, so as to form a raised part in the width of the soffit in the casting mould, as shown at A in Fig. 2. Where practicable, the latter way is the best, as there are no plain mouldings to cast in short lengths, therefore no joints in the plain members, and a better lapping joint is obtained. This will readily be seen by comparing the joint at the cavetto members at each side of the soffit on Fig. 2. An original dentil should be made and moulded to cast as many as will make up the full length of the moulding piece. The original dentil is made with a slight draft on both sides, and springing from the inner angles and diminishing to the face and end arris, as from A to D, Fig. 5. The face and end of the dentil being equal in width, the inward draft is imperceptible, especially in a row of dentils. This allows the mould to leave the moulding piece, and the cast to leave the mould, without excessive dragging or fear of chipping. Where there are several moulds required, it is advisable to have a solid moulding piece. This is often compulsory, from the fact that a long moulding piece having several short casts fixed on the ground, one or more casts often come apart when the first mould is taken off. A solid original is then taken out of the mould. If the enrichment is deep at parts, and has but little draft, these parts in the first mould will be drawn up and form ragged edges. The edges are cut off, and the wax smoothed with glass paper, or with Dutch rush, using paraffin oil as a lubricant. Smith's Metal is an excellent material for moulding enrichments for reverse moulds. For permanent moulds, it is a good substitute for wax.

CASTING FIBROUS ENRICHMENTS.—Casting fibrous enrichments for bedded work is a simple process. Two sheets of canvas are used, but no laths, unless the work is large, such as friezes or coves, girthing over 6 or 7 inches. The backs and edges of the casts need not be made smooth, in fact the rougher the better, as this gives a better key when canvased and brushed with the cornice. After the first two or three casts are taken out, the others will come easily. When the plaster is set, the moulds (if wax) are placed in warm water to make them more pliable. It will be seen that the wax moulds on the sketches are hollow on the backs. This not only saves the wax for other and immediate purposes, but also allows the mould to be more quickly warmed, and made pliable. The frames give sufficient strength to a mould, however thin the wax may be. As the

casts are thin, and have no laths, they are difficult to take out without collapsing. This is avoided, and the cast strengthened, by placing a piece of running rule on the cast, and then laying strips of canvas about 9 or 10 inches apart, and brushing the ends that lie on the cast. These rules are termed "hand rules." They afford a good leverage, and give a point of resistance to the end of a file or a chisel when prizing the cast up, and a good grasping place to lift the casts out of the mould. Fig. 13, on illustration No. 138, is a view of the mould and cast of the bed-mould. This shows the sections of the mould and the cast, the latter being white and the former black, with the frames at each side. R is the hand rule, with three strips of canvas, ready for the ends to be brushed. Two rules, one at each side, are used for wide casts. When the casts are out, the strips are cut at the lower edges at both sides of the rule, which frees the rule for the next cast. The brushed strip ends are left on the cast. When the casts are extra thin or difficult to draw, a canvas strip is brushed over the full length of the hand rule. As previously stated, the dotted lines on the casting moulds indicate the back surfaces of the casts, but no nicety is required for the backs, as they may run below the edges of the frames, as shown at Fig. 12. This enables the cast to be drawn out more freely. When filling in the dentils, small pieces of canvas are required to fit each dentil, in order that the canvas may be brushed into all the angles, and to render the cast light yet strong.

CASTING FIBROUS PLASTER ENRICHED CORNICES: FIXED ENRICHMENT SYSTEM.—Enrichments for this system are cast separately, and then fixed on the cornice cast. The general process is similar to that used for solid work, except that the fibrous casts are made in long pieces, and fixed on the cast of the cornice with fine nails, and sometimes with putty and plaster. The enrichments are cast with two coats of canvas for large work, and one coat for small work. Two small laths, each from $\frac{3}{4}$ inch to $1\frac{1}{2}$ inches wide, and from $\frac{1}{2}$ inch to $\frac{3}{4}$ inch thick, are laid along each side of the cast, and the canvas margins turned over and brushed. These laths are termed "fixing laths," and as their name implies, they are used for fixing purposes. When casting the cornice, corresponding laths are inserted at the beds of enrichments to receive the fixing nails. The moulding pieces and moulds for the enrichments are formed in similar lengths and in a similar way to that described for bedded enrichments, with the exception that no bearing and lapping parts are required. The ground or run profile must be made to fit the bed of the enrichments on the cornice casting mould. This of course is done when setting out the reverse running mould. The casts are fixed with fine sprigs, or French nails, using plaster for the side and end joints, as described for fixing fibrous cornices. Small thin casts may be fixed with fixing plaster alone. This was the first system used for forming fibrous enriched cornices, and is still the most common in use, being the most easy, and more like the old or "solid" way. The completed cornice casts are not so light, or the joints between the plain and enriched members so strong, as by the "bedded" and the "cast" systems, but it allows more freedom for seeing and arranging the mitres.

CASTING FIBROUS PLASTER ENRICHED CORNICES: CAST ENRICHMENT SYSTEM.—Enrichments by this system are cast with and at the same time as the cornice, or in other words, the cornice and the enrichments are cast in one operation, hence the term "cast enrichments." By this system the moulds of the enrichments are laid in the cornice casting mould, thus forming one complete mould, which allows the enriched and plain members to be cast complete in one operation. The moulds are made in long pieces, and jointed as with fibrous casts for bedded work. They are made with wax or jelly as required, and can be used as "loose pieces."

The annexed illustration (No. 139), drawn to scale, elucidates the cast enrichment system. Fig. 1 shows a combined section and elevation of an enriched cornice. S is the section and E is the elevation. A on the elevation is an enriched crown-mould. The depth of the flutes is shown by

the dotted line on the inside of the section. C is an enriched cove. The profile of the ornament is expressed by the dotted lines on the outside of the section. B is a bed-mould with a raised enrichment, as shown by the dotted line on the outside of the section. P, on the section, is a "pendant patera" which is placed at regular intervals on the soffit, as shown in the elevation, and on the plan of the soffit at Fig. 2. This has a sunk panel SP between the pateras. One of the pateras is omitted to illustrate another method of working, but its position is indicated by the circle line CP. The panels are formed by the circular styles (C,C) which connect the fillets or straight styles (S,S). In order to show these straight and circular styles while being made and when finished, the joint at one side is shown open, and the other as stopped. The sunk panels

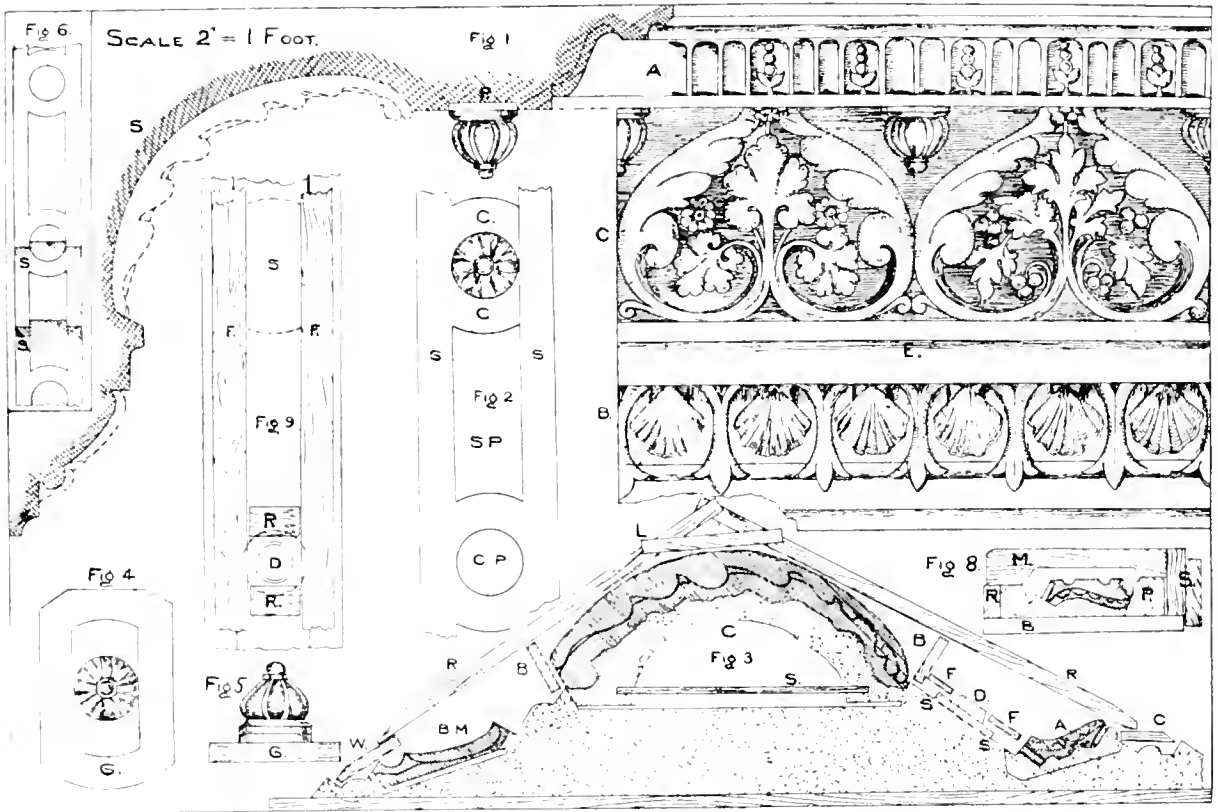

NO. 139. CASTING FIBROUS PLASTER ENRICHED CORNICES BY THE CAST SYSTEM. COMBINED PLASTER AND WAX REVERSE MOULDS.

can be constructed by two different methods. By the first method, as used in the present case, the straight styles are cast with the cornice, as shown at S,S on Fig. 3, which is a section of the casting mould. The circular styles and patera are cast and then fixed between the straight styles, thus dividing the space from mitre to mitre into panels. For this purpose, a moulding piece of the combined circular styles and patera is made, moulded, and the required number of casts got out. The plan of the combined styles and patera is shown at Fig. 4, and the section at Fig. 5. G in each case is the ground of the moulding piece. This also illustrates the method of making a moulding piece for a jelly mould. One end of the ground has splayed angles to form a distinction from the other. This gives a ready guide for always placing the case on the moulding piece in the same

position as first made, so that it will not injure the model. This distinctive guide is also used for correctly placing the jelly mould in the case when casting. The above is the method adopted when joggles are not used. The pateras in this design spring from or are placed on the surface line of the styles, but in most designs they are placed on the surface line of sunk panels—indeed they look better in the latter way. The former is only given to show one method of constructing combined parts. The second method is the reverse to that of the first. The first part of the second method is done when setting out the reverse running mould to run the cornice casting mould; the surface lines of the straight styles must be continued to form one straight surface as indicated by the dotted line from *s* to *s* on Fig. 3; this forms a bed for the panels. Moulding pieces of the oblong sunk panel (*SP*) and the circle sunk panel (*CP*), on Fig. 2, are made and moulded with wax or plaster, and as many casts got out as there are panels in the length of the cornice mould. They are then fixed on the style surface, as from *s* to *s*, the position of each being previously set out, thus forming the style surface into a reverse casting mould, which enables the cornice mould to produce the sunk panels and the other plain and enriched members in one complete piece. Fig. 6 shows the plan of styles and panels as placed in the cornice mould. *s* and *s* are the sections. The panel casts (and all other made-up parts of reverse casting moulds) should be fixed with fixing plaster, and then further secured with screws to enable them to resist the damp and repeated pulling when casting.

Fig. 3 shows the section of the cornice casting mould, with the moulds of the enrichments in position. The plaster with which the cornice mould is formed is indicated by a dotted surface, and the wax moulds by black-lined surfaces. A framed wax mould is used for the lower bed-mould (*BM*). The bed in the cornice mould must be made about $\frac{1}{4}$ inch larger than the wax mould to allow for fixing it firmly and true. The bedding is shown by the clear space between the main and the wax moulds. The top bed-mould (*A*) is also made with a framed wax mould. Sections of the frame rules are in each case shown in the moulds. Although not actually required for this section of cornice, the enrichment mould (*A*) is shown as a "loose piece" to illustrate another method which is desirable in some works. The method of making an "enriched loose piece" is as follows:—

Fig. 8 elucidates the method of constructing a wax mould to act as loose pieces in a plaster reverse casting mould. A run profile, as *P*, which is precisely the same as the enriched part, is required as a ground for making and moulding the enrichment with a running mould. As it is difficult to get a series of wax moulds all one thickness and form on the backs so as to accurately fit the bed in the main mould, which is imperative for a loose piece, a "run plaster case" is used to give a uniform shape and size to each length of mould. This is done by means of a running mould cut to the section of the bed. When the wax mould is made, the back is left rough, to give a key for the case. The exposed parts of the run profile are shellaced and oiled (but not the wax mould). Gauged plaster is then laid over the whole surface, and the back formed with the running mould. The various parts are shown in this figure, and are as follows:—*B* is a section of running board on which the profile (*P*) is run. The dark-lined surface is the wax mould. *M* is the running mould with a rebated slipper (*S*) to run on the side of the running board, and the nib to run on the running rule (*R*). The mould with its plaster back is shown in position at *A*, Fig. 3. The cove mould (*C*) on Fig. 3 may be made in wax or jelly as required. A case or backing for this mould must be used. The plaster case is indicated by the dotted surface. *S* is a section of one of the stays or braces, which are placed at intervals to strengthen the mould. The moulding pieces for the enrichments are made in long pieces, and the moulds jointed as described for "bedded enrichments." The moulds—especially if made with jelly—are best when made to the full length of

the proposed cornice cast. This saves jointing, and it is as quick and as easy to make one long mould as it is to make three or four short moulds to make up the desired length. A bed for the enrichment moulds must be allowed for when setting out the reverse running mould for the casting mould of the cornice. Having run the main mould, and made and bedded the enrichment moulds, filling in the whole mould to obtain a complete cast now claims attention.

Casting or filling in the mould is performed as described for previous cornices, but in order to explain a subject in connection with fixing points and patera fixing, in this class of work, further details are given. Fig. 3 shows sections of the various laths used for the cornice cast. The letters correspond with those already described, C, W, B, R, and L being the ceiling, wall, body, rib, and lap laths respectively. F and T are fixing laths which are laid, canvased, and brushed with the cornice cast so as to form fixing points for the casts of the combined styles and patera, as made by the first method for sunk panels. Fig. 9 shows the plan of the fixing laths (F and T). The position of the cast is indicated by the dotted lines at S. Similar laths are used for the casts. The corresponding laths afford secure fixing points for the nails or screws which are used for fixing the casts to the cornice casts. This method is precisely the same as that used for "fixed enrichments." A slightly different method is adopted for pateras that are used alone, or fixed on the surface line of panels. The first thing is to form a series of fixing holes in the cornice cast, each hole being made in the panel or other part intended to receive a patera. This is done by fixing a raised "die" or block on each panel surface line, as shown by the section of one at D, Fig. 3, and on the plan at D, Fig. 9. The dies may be cast or cut out of a plaster ground, as required. The diameter of the dies should be about 1 inch less than the diameter of the bearing parts of the pateras, so as to allow for a bearing on the panel as shown by the dotted line at D, Fig. 9. The continued double line is the radius of the die, and the dotted single line is the radius of the patera. When the cornice cast is being filled in, the fixing laths (F and T) and the "rib fixing laths" R and R', as shown at D, Fig. 9, are used to form fixing points, and to strengthen the edges of the holes. The canvas is laid over the dies, but not brushed on the raised surface. When the cornice cast is set, the unbrushed canvas is cut in three or four places—from the edge to the centre—so as to form three or four "tags." These are left on the cornice cast, and are afterwards used for fixing the patera to the cast. When the cornice cast is taken out of the mould, the pateras are fixed on it by the aid of two or three fine nails or screws. The canvas tags are then turned down into the hollow inside of the patera and well brushed, thus giving a secure fixing and a sound joint. Fixing by the tags alone is sufficiently strong for small and light hollow casts. The tags may be supplemented by brushing canvas strips over the inside joints. Tow is also used for this purpose. It makes a strong joint, and is useful for small or acute angles, or where there is insufficient space for canvas. When brushed, it clings to dry fibrous work even better than canvas.

FIXING FIBROUS PLASTER CORNICES.—Fibrous plaster cornices, and most fibrous works, are fixed with French nails or with screws. The latter are preferable, because screwing up is not so apt to jar or chip the work as the hammering of nails. Brick or stone walls require to be "plugged," and wood fillets fixed on the plugs, to form a ground for fixing the cornice on. The fixing is done through the ceiling and wall members and laths. The ceiling member of the cornice is fixed to the joists. If the joists which run longitudinally at two sides or ends of room are not in a line with the ceiling member, a special fillet must be fixed between the joists for fixing purposes. If the walls are lath and plaster, the members can be fixed to the wall or partition studs. Fixing grounds must also be inserted at the joint where large cornices are made in two or more longitudinal sections. Iron girders or other iron framework intended to be covered with fibrous plaster should be

perforated or so arranged that it can be plugged or wedged to receive fixing fillets. Concrete walls or ceilings can be constructed with wood plugs, fillets, or concrete fixing blocks. These are built in as the work proceeds, as described for concrete stairs and floors. When all the fibrous work is fixed, the joints and mitres, also the countersunk screw holes, are stopped with plaster gauged with size water. The parts to be stopped and made good should be wetted with size water. This stops the suction sooner than pure water, and therefore is not so liable to soften the plaster. Nail and screw heads (unless they are galvanised) should be coated with shellac before the holes are stopped, to prevent rust or discoloration appearing on the surface of the work. When fibrous plaster cornices are made to the finished ceiling and wall lines, they should be fixed on the floating coat, and the setting laid up to the cornice. If the walls are set before the cornice is fixed, the setting can be cut down to the floating, allowing a margin about 1 inch wide at the ceiling and wall lines, and when the cornice is fixed the margins are made good. The margins may also be left while the setting is in progress. This makes a cleaner and stronger joint than if fixed direct on the finished surface. When it is imperative to fix on a finished surface, the cast rims should be made true and strong, and well stopped when fixed, to prevent the joints opening. Fibrous work is often required to be fixed on old plaster work. In this case the walls (unless lathed) must be plugged at intervals to form fixing points. All joints between fibrous work and solid work should be stopped with plaster gauged with lime putty water and slowed with size water. The putty water corrects plaster expansion and renders it more tenacious. Wide or deep joints should be made up with plaster and canvas. When the rims of the casts are increased in thickness to allow for thicker laths, the cornice is fixed to the brick and joist lines. This should be done on the actual work before the mould is made. Room must be allowed for this, also for a fillet. Unless these precautions are taken, difficulties will arise when fixing, and the cornice may not have the same projection at the ceiling and wall lines as shown on the drawings.

FIBROUS PLASTER MEASUREMENTS.—All dimensions for fibrous plaster work should be taken (where practicable) from the actual work or foundation intended to be covered, for unless this precaution is taken, it will be necessary, in many cases, to alter the size of the fibrous work by cutting or making it up to fit the structural work, which, in some instances (especially iron work), vary in size or form from the drawings. The expense incurred by the alterations has generally to be borne by the plasterer, whereas it should be paid for by the contractor, whose work is not in accordance with the drawings. Even if allowed for, it is often the cause of much unpleasantness. When setting out fibrous work for cornices and ceiling or wall panelling, care must be taken to allow for the extra thickness required for the lath framing in large casts, also the wood fillets or wall battens that are used for fixing purposes. It is usual to allow about 1 inch for lime plaster, but the thickness for fibrous work will vary from 1 inch to 2 inches or even 3 inches for large casts or heavy work.

FIREPROOF FIBROUS PLASTER.—Plaster is one of the best known fire-resisting materials, but when used in combination with wood, as in fibrous plaster, there is not a sufficient body of plaster to protect the wood backing, and unless proper precautions are taken, fibrous plaster may be overcome by fire in the same way as any wood work used in the construction of buildings. The outer or plaster surface will resist the effects of fire equally as well, if not better, than constructional wood work. The weak part is the back where the wood is exposed to flames, as for instance, fire that takes place in overhead floors, wood partitions, or similar constructional wood work. When fireproof work is required, it is necessary to protect this wood backing. This may be done by brushing all exposed wood and canvas with plaster gauged with slag dust,

or with fine engine ashes, or tile, brick, or terra-cotta dust, or by covering these parts with slag wool, either in a dry state, or mixed with gauged plaster. Canvas may be rendered incombustible by steeping it in a strong solution of borax. A solution of phosphate of ammonia with sal-ammoniac will answer the same purpose. Wood is also rendered less incombustible by immersion in either of these solutions.

Metal sheets or laths may be substituted for the wood backing and laths, and in some cases wire-netting for the canvas. When the Alexandra Palace was destroyed by fire in 1873, it was stated in one newspaper that the rapid progress of the fire was due to the fibrous plaster with which the ceilings and principal decorations were composed. This statement is incorrect. The rapid spread of the fire was entirely due to the great amount of constructional wood used, large coves, domes, and other surfaces being simply covered with a thin body of fibrous plaster work, the large spaces behind causing draughts, which drew the flames to the wood work, and practically fed the fire. The fire, I believe, originated by a plumber's "devil" on the roof. Fragments of fibrous plaster found among the ruins were blackened and scorched on the outer surface, and in some instances the wood backing was charred down to the plaster surface. J. Wilson, a plasterer, who was at work on the original building, and at the rebuilding, had several of these fragments in his possession for many years. When the Oxford Music Hall was burnt down in 1868, there was a small portion of fibrous plaster which resisted the effects of external fire, the greater portion being destroyed by inward fire and falling walls, yet some small fragments found in the *débris* showed that the plaster, although practically useless, had to a certain extent resisted the combined effects of fire and water. I am not aware if this fibrous plaster was specially prepared, but being painted, it would probably better resist the effects of fire. Fireproof fibrous plaster may resist fire and for a time stay its progress, but unless the work on which it is fixed is also protected, it will be impossible to make the building fireproof.

FIBROUS PLASTER DECORATIVE SHEETS.—Fibrous plaster sheets have been successfully used as a decorative finish or covering for plaster walls and ceilings, and for wood, stone, and iron surfaces. Fibrous plaster sheets can be made to any desired design or size, and are constructed as follows:—For example, take the design as being 3 superficial feet before being repeated. The design having been modelled, it is then moulded with wax, and as many casts got out as will make a moulding piece 9 or 12 feet long, as required, the width being the same as the original model, or it may be repeated and made 6 feet wide, but in either case it must be jointed so that the design will intersect at the sides and ends. The depth at the sides and ends of the ground of the moulding piece to the surface must not be more than $\frac{1}{16}$ inch, this being sufficient to allow the mould to give the line of the joint. This is moulded with wax, jelly, or plaster, as desired. Wax is the best for most purposes, as it is clean, sharp, durable, and pliant for a large flat surface. The mould is filled in with extra fine plaster, gauged firm with the best size water, and then a sheet of extra fine and thin canvas is laid and brushed, taking care that the ground of the cast is not more than $\frac{1}{8}$ inch thick. No wood is used for this kind of work. The cast is taken out and laid on a flat surface to dry. After this, it can be rolled up in a loose form, as to "Linerusta Walton." If colour is not objected to, the cast can be rendered very tough by coating or soaking it in a strong solution of hot glue. The casts are fixed on walls or ceilings with strongly gauged putty and plaster and size water. If the walls are dry, the casts can be fixed with a paste composed of white lead thinned down with linseed oil, and then gauged with fine plaster. The fixing material, whatever it may be, is spread evenly on the wall, and the cast pressed on to it, using flat pads or brushes to press them down. The joints are then stopped in

the usual way. An example of this work, designed by Mr W. Emden, architect, can be seen on the staircase walls at St James's Hall, Regent Street.

MUSLIN PLASTER CASTS.—Fine and thin casts for plaques, delicate panels, or coving wood or metal work, are made with one or two sheets of fine but open muslin and plaster, made in a similar way to fibrous plaster sheets. The casts are light and strong, and being as thin as paper, they are quite flexible, and may be bent to any curve. They can be fixed with glue, with white lead, or plaster, according to the material to which it is to be fixed. Muslin plaster casts may also be used for a variety of decorative purposes, by fixing a series of casts on to a canvas ground, and then fixing the whole in one piece, or several large pieces, to make any desired design.

PLASTER AND TOW CASTS.—Tow which has been well chopped or teased, and then gauged with plaster and size water, can be used with advantage for small or thin work, also in thin or narrow parts of moulds, when canvas would be too thick or difficult to turn over. A little teased tow makes an excellent material when dipped in gauged plaster for fixing plantings on fibrous work, also on solid work. The planting is fixed on the face of the main cast with "seconds," in which short chopped tow has been mixed. The cast is then turned over, unless in a position to work it from both sides, and the joint is brushed over with "seconds," and loose dry teased tow laid on and over the joint, and then brushed with "seconds." This makes a strong and clean joint. When casting pieces for plantings, or fixing on the work, tow may be used for the whole cast, or for the sides only, according to the size or kind of work; but in either case the whole of the tow should not be dipped or brushed with plaster, so as to leave a part at the edges in a loose and dry state. This dry part, which projects above the edge of the cast, is brushed on and over the joint of the main cast when fixing. This makes a strong key to unite the two pieces together. When casting circular casts for planting, a combination of canvas and tow will be found useful, canvas being used for the inside or flat parts, and tow for the small parts and the outside edges. No wood or wire will be required for small work, if tow, well saturated with plaster, is used to form an edge. It has already been stated that plaster and tow are used for modelling figure and theatrical decorations and properties; also that tow, instead of canvas, is used for fibrous plaster in France. The further use of tow will suggest itself for many plastic purposes. Tow is very strong, as may be proved by trying to break a single fibre.

RAPID PLASTERING.—Ancient records and examples afford ample evidence that plaster slabs were used in remote ages by the Egyptian, Saracenic, and Moorish plasterers. Slab plastering is used for producing ceilings and partitions in plaster or cement, whereby the operation of "lathing," "pricking up," and "floating" are dispensed with. Moreover, the delay necessary to allow the lime plaster to dry after each of the above-named operations is avoided, as the foundation or body of the ceiling is made beforehand, and requires only to be nailed up and set with a thin layer of plaster or cement in the ordinary way. Papier-mâché slabs were first used in England by Bielefeld as a substitute for lath and plaster on the ceiling of the Reading Room at the British Museum. The present form of plastic slabs is the outcome of fibrous plaster. The rapid system of plastering by means of fibrous plaster slabs and a thin setting coat was patented in 1875 by R. W. Hitchins, a London plasterer.

These slabs consisted of a layer of plaster, two sheets of canvas, and a lath in the sides. They were about $\frac{1}{2}$ inch thick, and the sides and ends bevelled so as to overlap each other. In 1882 Hitchins obtained a provisional protection for "improvements in, and in machinery for making slabs of plaster or composition for ceilings and other purposes." The plaster was

gauged by machinery, and the slabs made in a continuous length, and cut with a guillotine knife to the length required. Hand-made slabs have been successfully made, but machine-made have not proved in practice what was advanced in theory. The advantages claimed for slab work are rapidity, strength, cleanliness, and lightness. It is rapid because there is no lathing or lime and hair required, and the slabs are fixed and the surface set in one operation, therefore there is no waiting for each coat of plaster to dry. Strong, because having a certain amount of plasticity, and being bound with canvas, they are not liable to crack or fall when subjected to the vibration of machinery, or the moving of heavy goods above. Clean, because being made in the workshop, and only requiring a setting coat when fixed, there is little or no dirt and rubbish caused in the building. Light, because it is nearly one-third the weight of three-coat plaster work. It is practically sound and fireproof, and is far superior to match boarding, owing to its greater resistance to fire. This fact is so recognised by the Fire Insurance Companies that the premiums are less for plaster than for wood linings for walls and ceilings. The London School Board are equally agreed as to the dangerous character of match boarding, and have adopted slab plastering for their new schools. It can also be made and fixed in much larger sections than is possible with match boarding, and there is no shrinkage or opening of joints, therefore no harbour for dirt and vermin, as is often found in match boarding. This proves its superiority from a sanitary point of view. Slabs can be made to any desired size or form, but they are generally made 2 feet 6 inches wide, and in lengths from 3 feet to 4 feet, the lengths being so regulated that the joints will come on the centre of the joists. For special purposes the lengths and widths are regulated so that whatever way they are fixed the joints will be on the centre of the joists. When dry, they can be cut with a saw to fit any angle, or make up small parts. They are generally made from $\frac{1}{2}$ inch to $\frac{3}{4}$ inch thick, according to the class of work for which they are intended. The thickness should also be regulated according to the distance apart of the joists. For instance, slabs $\frac{1}{2}$ inch thick, when fixed on joists 12 inches apart, will stand the strain of trowelling while being set, and they will resist vibration or overhead rolling or falling of heavy bodies; but if the joists are 14 or 15 inches apart, the slabs should be $\frac{3}{4}$ inch thick, to give them equal power for the increased span. Increased thickness also renders ceilings or partitions more sound-proof. The slabs are made with one face left rough to receive a finishing coat when fixed. The other side being smooth, they can be used for temporary building by fixing the smooth surface outward, and then stopping the joints with plaster, and colouring the whole as required.

Fibrous slabs can be advantageously used for counter ceilings, and for pugging or deafening boards, also for covering wood or iron work as a protection from the effects of fire. They may also be used for warehouses and similar buildings, where time is a desideratum. Plaster being the principal material, and the most in bulk, that is used in their construction, great care is requisite in its proper gauging and general manipulation, for unless this is attended to, the slabs will be soft in body and unequal in surface hardness. Plaster that is excessively or unequally gauged becomes soft and spotty, *i.e.*, alternately soft and hard patches, and it will not stand the test of time like the old-fashioned lime-and-hair plaster work, which is improved by repeated gauging and working. It may be thought that the setting coat will give a hard and uniform surface. The setting will certainly cover, and for a time hide the slab's defects, but the work will never be sound, safe, and satisfactory. It is well known that no superstructure or veneer, however strong in itself, can be laid sound and solid on weak or unequal foundations. Soft or spotty slabs are not only difficult to set, but take nearly double the time required for well-made slabs. These defects, which are often the results of unskilled labour, are liable to bring a useful branch

of the plasterer's craft into disrepute. Slab-making is a useful branch of the craft, as it can be used for the employment of plasterers during frosty weather when building work is suspended.

FIBROUS PLASTER SLAB MOULDS.—Following the proper rotation in the manufacture of fibrous slabs, the method of mould making is given first. Slab moulds are usually made on a bench, the top surface of which forms the surface of the mould. They are termed "bench slab moulds," to distinguish them from an independent mould. The top of the bench is generally composed of plaster or Portland cement, and sometimes wood, iron, or zinc sheets are used, but plaster being the readiest and cheapest, it is best for temporary purposes. It will be seen by the illustration No. 140 that this bench is made to contain four moulds, each one being for a full-sized slab, viz., 4 feet by 2 feet 6 inches. The frame of a bench this size is generally supported on eight legs, but if the top rail is extra thick and well secured, six legs will be sufficient. The bottom long rails are fixed on the inside to give greater leg room for the worker. A centring of rough board T is nailed on the

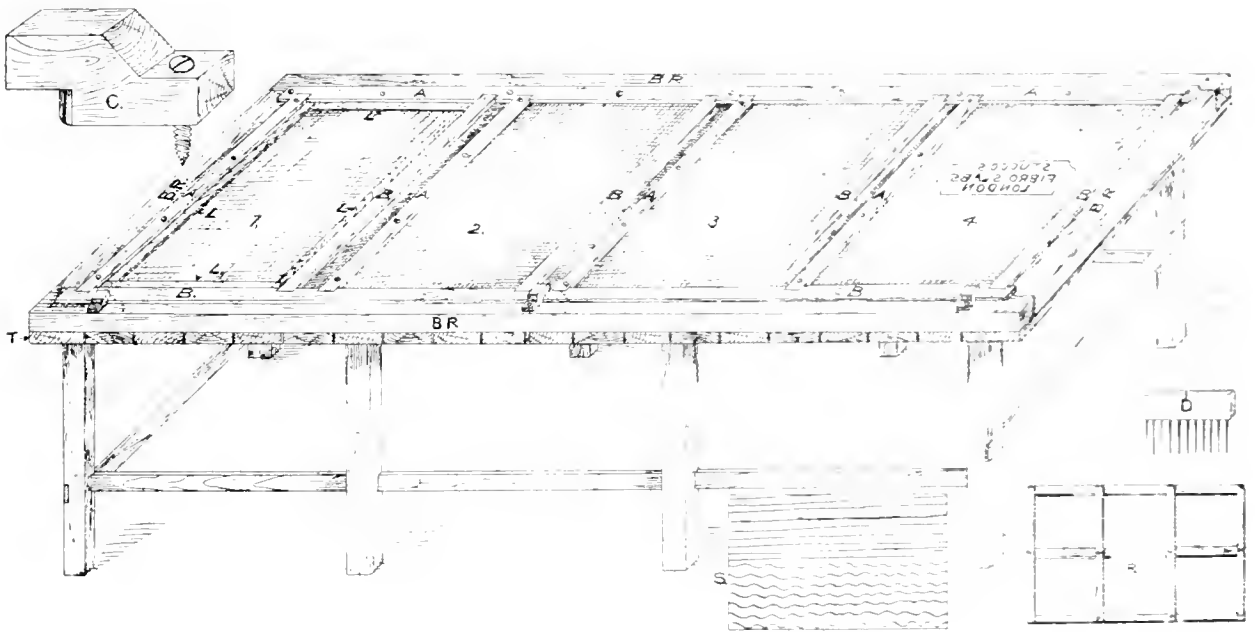

No. 140.—BENCH SLAB MOULD.

frame, keeping the joints about $\frac{1}{4}$ inch apart, to allow for any after-swelling that may ensue after the plastic top surface is laid. On this centring the bench rules BR are fixed. They form a permanent bench edge and fence to keep the plaster surface in position. The bench rules are 3 inches wide and $\frac{3}{4}$ inch thick, and planed on the upper and outer surfaces. Two or more widths may be required for the ends of the bench, to allow for fixing points for the mould rules and the clip screws. Having fixed the bench rules firm and level with each other, nails are then driven into the centring surface. They are placed about 4 inches apart, and left projecting, to form a key for the plastic top. Neat plaster is generally used for the finished surface, but owing to the continual damp when in use, it does not wear well. A more durable surface is obtained by admixing 1 part of ground lime to 3 parts of plaster, and gauging it stiff. Hydraulic lime gives better results than chalk lime for this purpose. For permanent purposes nothing equals Portland cement, or iron plates, or zinc sheets. If plaster is used, it must be seasoned with linseed oil,

though litharge oil applied hot makes a better and harder surface. Soft soap should not be used, because although it stops the suction, it does not harden the surface, and the plaster is apt to scale and chip when used for slab-making. The soapy nature makes it difficult to repair. Having finished the surface, it is set out into the mould sizes. The sides and ends of the moulds are formed with wood rules, termed "mould rules." They are about $2\frac{1}{2}$ inches wide and $\frac{1}{2}$ inch thick, and in lengths as required. They are planed on all sides and edges, and are brushed with liquid shellac. The shellac tends to harden the surface and prevent the oil or grease from being absorbed when casting. This also allows the slabs to leave the mould more freely, and the rules to be freed from plaster splashes with greater ease. The long and cross mould rules marked A are fixed rules. The rules marked B are loose mould rules. The cross ones fit into sockets which have been previously cut in the long mould rules, thus keeping the four cross ones in position. The four cross fixed rules the A's hold the loose front rule in its longitudinal position. This is locked by means of the three clips as shown. C shows an enlarged view of a clip. It revolves on a screw, thus forming a speedy fixing, and always on the spot and ready for use. The finished bench is about 2 feet 6 inches high, or according to the stature of the worker. A man can work with greater ease and reach farther over a low bench than he can over a high one. A platform is sometimes made under the bench, resting on the lower rails, for storing cut laths, &c. Never keep canvas underneath, as it is apt to become hard or lumpy through plaster splashes. Canvas is best kept overhead within easy reach. The mould rules are sometimes held in position by means of pegs or pins, but the above method with the fixed and loose rules and the clips is the quickest and most reliable way for ensuring an equal size and form of slabs. Smaller slabs can be cast out of the same moulds by laying width rules in the mould as required. It sometimes happens that slabs from different makers are sent to one place. It is therefore advisable to have the maker's name on each slab as a means of identification. This also forms a good advertisement, and is done at a small cost by fixing a metal or hardened plaster name-plate on the surface of each mould, as shown in No. 4 mould. The foregoing explanation of the bench slab mould in the illustration will make the method of making and its use tolerably clear. The other sketches on this illustration elucidate the method of making slabs, which is as follows:—

FIBROUS PLASTER SLAB-MAKING.—The materials for, and the method of making fibrous slabs, are as for fibrous plaster plain panels. But an additional body coat of plaster, alone or with other materials, is given, to make up the requisite thickness. The canvas is coarser and more open than for fine fibrous work, and the frame laths vary from 1 inch to $1\frac{1}{2}$ inches in width, and from $\frac{1}{8}$ inch to $\frac{3}{16}$ inch in thickness, the lengths being regulated by the size of the slabs. Various materials are gauged with plaster for the body coat. One of the first used was fibre or coir. This is the outside coating of cocoa-nuts, and may be obtained from matting factories. Waste fibre or short ends are also used for slab-making. A mixture of fibre and sawdust in equal parts gives good results. Mr T. Jones, a well-known Liverpool plasterer, makes good slabs with only sawdust and plaster for the body. Waste cork, bark from tan-pits, peat moss, shavings, straw, hay, bracken or ferns, reeds, rushes, bamboo and other canes (split and whole), and similar materials have been employed as aggregates for this purpose. When bark or similar materials are used, they must be beaten or chopped to free them from lumps, and also dried, before gauging with plaster. Coarse plaster alone is sometimes used, but this makes the slabs heavy and brittle; while if gauged with fibre or sawdust, or both in combination, the coarse plaster is less heavy and more tenacious. The moulds are usually oiled with Gallipoli oil (a cheap class of sweet oil). Another way is to grease them with a "tallow pad." This is made by laying about half a pound of common tallow in a

double ply of canvas, about 8 or 10 inches square, and then tying up the ends with a string. If the tallow is hard, beat it on a wood block until the tallow will work freely through the canvas. The moulds are quickly and more equally greased with the tallow pad than with oil. The slabs also leave the moulds freely, cleaner, and with less chipped edges. When the moulds are in good working order, they will only require greasing once or twice per day, and then using a solution of soft soap for the other casts. Having cut as many laths and sheets of canvas as will last for a day or more, and greased the moulds, the gauging is next proceeded with. Gauge as much plaster in a pail as will cover the surface of the mould with a surface coat about $\frac{1}{4}$ inch thick. This must be gauged stiff and quickly. Also gauge another quantity of plaster with size water. Both gauges should be done at the same time, a man gauging the "neat plaster" while a boy gauges the "sized plaster." All the plaster should be scraped out and the pail washed out after each gauge. Pour the neat plaster into the mould, and spread it with a laying trowel; then lay a sheet of canvas over it, leaving an equal margin lying over the mould rules or rims as described for plain panels, and then with a trowel press and lay the canvas evenly and close up to all angles and sides of the mould. Next charge a large brush an old stock brush will do with sized plaster, and brush the whole surface, to thoroughly incorporate the surface coat and the canvas in one body. After this, brush the bed of the laths, and lay them in position, as shown by the four L's in No. 1 mould, and then brush the laths and fill up any crevices that may be left between the laths and the sides of the mould. While the laths are still moist, turn the canvas margins over the laths, and brush them well into the angles. The body coat is then gauged and laid flush with the mould rims and scratched. The body material is usually termed "fibro," and, as already stated, consists of coarse plaster alone, or more often gauged with an equal part of fibre or sawdust. Whatever material is used for the body, the plaster must be gauged stiff, and the aggregate mixed with it until the whole is of the consistency of well-tempered coarse stuff. While the canvas is still moist, the fibro is laid in the centre of the mould, and spread with a laying trowel, then ruled flush with the mould rims; and before the fibro is set the surface must be well scratched with a coarse broom or a wire drag, so as to give a good key for the setting coat. One sheet of canvas is sufficient for ordinary work, if the plaster is good and properly gauged. Two sheets are used for special work, or where the joists are extra wide apart.

When the slabs are set, turn the clips, and take off the loose front rule and the loose cross rules, and then insert the blade of a trowel in between the slab and the bench, and ease the slabs. They are then taken out and laid on a "slab rack." The novice had better try "his prentice hand" with one mould at first, and when he has mastered the gauging, noted the time of setting, and the amount of materials required for one mould, he can fill in two moulds at the same time, filling in Nos. 1 and 3 first, and while they are setting, fill in Nos. 2 and 4. The moulds are filled in alternately, to allow more space and freedom for working. This also allows more time for the first or intermediate slabs to set. When the slabs are taken out, it is usual to stack them on edge in racks. The racks are so arranged that there is a $\frac{1}{2}$ inch space between each slab, to allow a free current of air. The racks are fixed in a drying-room, which is heated by coke fire, or if time or atmosphere permits, the slabs can be dried by air currents. After they are dried, they are stored closely together on edge. Another way is to lay them on flat slab racks, which are made to the same size as the slabs, and are formed with wood fillets about 1 inch wide and $\frac{1}{2}$ inch thick. A rack is laid on the floor, and then a slab laid on the rack, and so on until the stack is man-high. This keeps them from buckling. On no account should slabs be laid

close together until thoroughly dry, as any contained moisture will render the plaster soft, and the slabs weak and flabby. The slab stacks should be kept in a dry place, and where there is a strong current of air. R (illustration No. 140) is the plan of a single slab rack. D is a wire drag. This is formed with a wood stock about 6 inches long, 2 inches wide, and $\frac{3}{4}$ inch thick. Into this is fixed a series of steel wires about $\frac{1}{8}$ inch in diameter, and placed about $\frac{1}{4}$ inch apart. The wires should be flattened at the points. The drag should be drawn along the surface in a zigzag form, holding it at an angle of 70°, so that it will give a wavy key. It may not be generally known that a series of zigzag indentations will afford a stronger key than a series of straight indentations. Both forms are shown on the plan of a slab s.

SETTING FIBROUS PLASTER SLABS.—Fibrous slabs are fixed with $1\frac{1}{2}$ -inch galvanised nails having good-sized flat heads, the nails being about 6 inches apart. When the slabs are all set, the joints are stopped with plaster, gauged with size water, leaving the surface rough. For common work they are set with gauged putty and plaster. If required for immediate use or painting, they are usually set with Parian, adamantine, or other white cement. Owing to the dry and porous nature of most slabs, it is necessary to correct the excessive absorption before commencing the setting, or the stuff will be difficult to trowel off, and liable to peel. The absorption may be stopped by brushing the surface with size water, and following on with the gauged putty and plaster as quickly as possible. If setting with white cement, the slab surface should be brushed with a thin solution of the cement intended for the setting coat, and then following on as before. This is best done by one man brushing the surface with the solution, and his partner following up and laying a skimming coat with a float. After this is all done, one man lays a thin finishing coat with a trowel, and his partner follows up and trowels off. The whole is then brushed off in the usual way.

FIREPROOF SLABS.—As already mentioned, plaster is one of the best-known materials for resisting the effects of fire, and to obtain a fireproof slab and the requisite strength it is necessary to use only those aggregates which are of themselves fireproof. Therefore, for this form of slab wire-netting is used in place of canvas, and fine slag, brick, tile, or engine ashes instead of fibre and similar vegetable aggregates for gauging with the plaster. The wire-netting should have a mesh from a $\frac{1}{4}$ inch to 1 inch, according to the required strength of the work. The wire is cut to the size of the mould, and laid so as to be in the centre of the thickness of the slab. This is done by laying the gauged plaster, mixed with an equal part of fine slag (or any of the other named aggregates), into the mould until about half full. This stuff is then beaten down and the wire laid in position. The remaining half of the thickness is made up with the same gauge, beaten, and ruled off flush with the mould rims, and the surface scratched as before. The moulds are the same as those used for fibrous slabs.

SALAMANDER SLABS.—Salamander slabs were patented by R. W. Hitchins. They are formed in a similar way to fibrous slabs, and are composed of silicate cotton and plaster. When these slabs are backed with silicate cotton they will withstand for a lengthened period a degree of heat which no other known material employed for building purposes can resist.

COMBINATION SLABS.—The foregoing notes demonstrate that silicate cotton is an important factor in fireproof plastic construction. This substance, which is also known as slag or mineral wool, being an incombustible, and non-conductor of heat or sound, is now largely used in conjunction with plaster for fire and sound proof purposes. It can be manipulated by means of wire-netting, and applied in a sheet-like form for fireproof plastering slabs, pugging, and fibrous plaster casing for iron columns and girders, and similar wood constructive work.

It is a waste substance from iron smelting furnaces. The wool is formed by causing a jet steam to play upon a stream of molten slag. Its great power as a non-conductor of heat is due to the fact that it contains a great volume of air. It is a well-known scientific fact that the material containing the highest percentage of air is the poorest conductor of heat. Air is subtle and rapid in movement when unconfined, and so slow to convey heat, except by its own motion, that it is at once the very best distributor of heat, and also the greatest barrier to its transmittal. 192 lbs., or 1 cubic foot, of raw slag make 192 lbs. of slag wool, or 8 cubic feet, hence it is seen that the wool encases eight times the quantity of air that the slag did. It is also an antiseptic, that is, a substance which assists or arrests putrefaction; therefore it is an excellent sanitary material, and will not harbour vermin. These properties render it useful for many plastic purposes. Fibrous slabs, and in fact all kinds of fibrous work, may be rendered practically fireproof by a combination of silicate cotton. This is done by encasing the upper or back surface of the slabs with a layer, about 1 inch thick, of silicate cotton, which is secured by means of wire-netting, and then fastened to the slabs. D. Anderson & Son Limited of Belfast, London, and Glasgow, who are the largest manufacturers of silicate cotton in the United Kingdom, supply this material for slab-making and other fireproof and sound-proof purposes in plastic and building purposes.

FIBROUS METALLIC SLABS.—Fibrous metallic plaster is a substance used for plain and decorative slabs and mouldings, &c., patented by the author. The work can be made to any desired form or size, whether plain or ornamental, and is intended for external purposes. It will resist rain and frost, and other atmospheric changes. It has been used as a constructive and decorative covering on wood framing for various buildings. It was employed for a portion of "Old London" and other exposed buildings in several of the South Kensington Exhibitions designed by Mr Wilson Benison, Architect to the Royal Agricultural Society. One-half of the façade of the American Exhibition, London, 1887, is executed with this material. It still wears as well as the solid-built half of the façade. It was used in the construction of a shooting-box in Belgium, and for many other similar buildings. The materials for fibrous metallic slabs have already been described.

EXTERNAL SLABS.—These slabs are made in a similar way to fireproof slabs, substituting Portland cement for plaster. They are generally made about 1 inch thick, the lengths and widths being regulated to joint on the wood standards or framing on which they are intended to be fixed. Owing to their hardness when set, provision for the screw holes must be made while they are being cast. This is done by means of pegs which are let into the mould surface, or as described for perforated slabs. Where lightness is desirable, coke-breeze or pumice-stone should be used as an aggregate in the proportion of 1 of cement to 3 of aggregate. Pumice-concrete weighs about 25 per cent. less than ordinary concrete. The slabs are set with neat Portland cement, or the Portland cement may be gauged with lime putty, as already described. The smooth face can also be used on the outside, and the joints neatly stopped with Portland cement, or they can be panelled by fixing small cement mouldings over the joints. The foundation for the slabs is thin wire-netting, or perforated metal sheets, tow being employed for acute angles. Slag wool in conjunction with cement, and held in position by wire-netting, is used for backing up parts where exposed to excessive heat. The slabs and mouldings are fixed with screws, but for fireproof purposes they are so arranged that they can be hung on metal hooks, or screwed from the back, so that no metal work appears on the outer surface. The inside fastenings are covered with a similar compound. Although it is not advisable to hasten the setting of Portland cement for solid or

constructive work, it may be done for this class of work without fear of failure. The quick setting may be obtained by mixing various materials with the cement, as already described.

REED SLABS.—The use of reeds or rushes in connection with plaster dates from the earliest period of plaster work. As already stated, reeds were used by the ancient plasterers long before the Christian era. They were used by the Egyptians and the Saracens in the construction of their mosaic and plaster work. Reeds are also found in the earliest examples of English plaster work, and they have been used up to the present time in the Midlands for the construction of plaster floors. As a substitute for wood laths, they have been employed up to the middle of the present century. They are also used in Germany in the construction of plaster blocks and slabs. Reeds are found in large quantities in the Fen districts. They are light, tough, and pliable, and form an excellent strengthening material for many plastic purposes. Reed slabs are made in similar moulds and ways as that used for fibrous slabs. The whole thickness of the slabs is composed of plaster (fine and coarse in equal proportions), with two layers of reeds. The reeds are placed in the centre of the slab's thickness, one layer crossing the other at right angles. The slabs are stacked and dried in a similar way to fibrous slabs. Bamboo makes an excellent material for strengthening slabs or other plastic work. The Japanese use plaster and bamboo for constructing some of their idols.

A. & O. MACK'S PATENT SLABS.—Mack's patent slabs are largely used in Germany and America in the construction of partitions, ceilings, and fireproof floors. They are made in various forms and sizes, and are usually composed of neat plaster. The slabs vary in thickness from 1 to 2 inches, and are perforated longitudinally with round channels.

GROOVED SLABS.—Grooved slabs are made in a similar way to reed slabs. They are usually composed of neat plaster, and vary in thickness from 1 inch to 1½ inches. Although simple, they are patented abroad, the merit claimed being the form of groove. The grooves are undercut, so that the finishing coat, when applied, will have a perfect dovetail at each groove. The grooves are about ¼ inch wide, and ¼ inch deep, and ¼ inch apart, and are formed by means of metal fillets, which are inserted in channels in the surface of the mould, and are drawn out when the plaster is just set, and before it begins to swell. Flexible fillets fixed on the surface would not be quite so costly as the sliding metal ones, and would answer the purpose equally well. Flexible fillets can be made with rubber, leather, or with gelatine, treated with bichromate of potash, which renders them insoluble in water. Undercut grooves may also be made by simply drawing an undercut drag or scratcher across the slab surface while the plaster is in a soft state.

PERFORATED SLABS.—Perforated slabs are an American invention, by which the slabs are constructed with a series of perforations for fixing purposes, each perforation and the whole slab being strengthened by wires. The moulds are made of wood or metal, with a series of wood or metal pins or pegs on the surface. The pegs are tapered and fixed about 9 inches apart, in rows to correspond with the ceiling joists, and left projecting flush with the mould rims. The wires are stretched longitudinally from end to end of the mould, and twisted or coiled round the pegs. They are coiled loose, so that they may draw off the pegs, and are placed near the centre of the slab's thickness. The moulds are then filled in with plaster in the usual way.

FINISHED FACE SLABS.—Finished face slabs, or "plain face," as they are sometimes termed, are used for panel surfaces, ceilings, covering rough surfaces, and a variety of other plaster purposes. They can be made in any desired shape and up to 60 superficial feet in size. They are made in similar moulds, and by the same method, as used for plain fibrous panels. Plate glass is sometimes used for the mould surfaces. This produces a fine, smooth, and polished slab surface. Kerosene oil or salad oil is employed for oiling the glass. The annexed illustration (No. 141) elucidates the

method of making plain face. Fig. 1 shows the plan of the casting mould and the various laths in position. The mould rules (the MR's) are 3 inches wide and $1\frac{1}{2}$ inches thick. Two sides are fixed, and two are loose. The latter are held in position by the former, and locked by the four clips H. Finished face slabs are either made with flush joints or with rebated joints. The latter way is used for the present purpose, and its use will be seen when fixing. Provision for the rebated joints is made by fixing rules ($1\frac{1}{4}$ inches wide and $\frac{1}{8}$ inch thick) on the mould surface, and close against the mould rules. Fig. 2 is a section of the mould and laths taken at T in Fig. 1. M is the wood and plaster surface, and R and S are the end and side sections of the rebating rules. The other letters refer to the slab, the making of which is next described. The letters on Figs. 2, 3, and 4 correspond with those on Fig. 1.

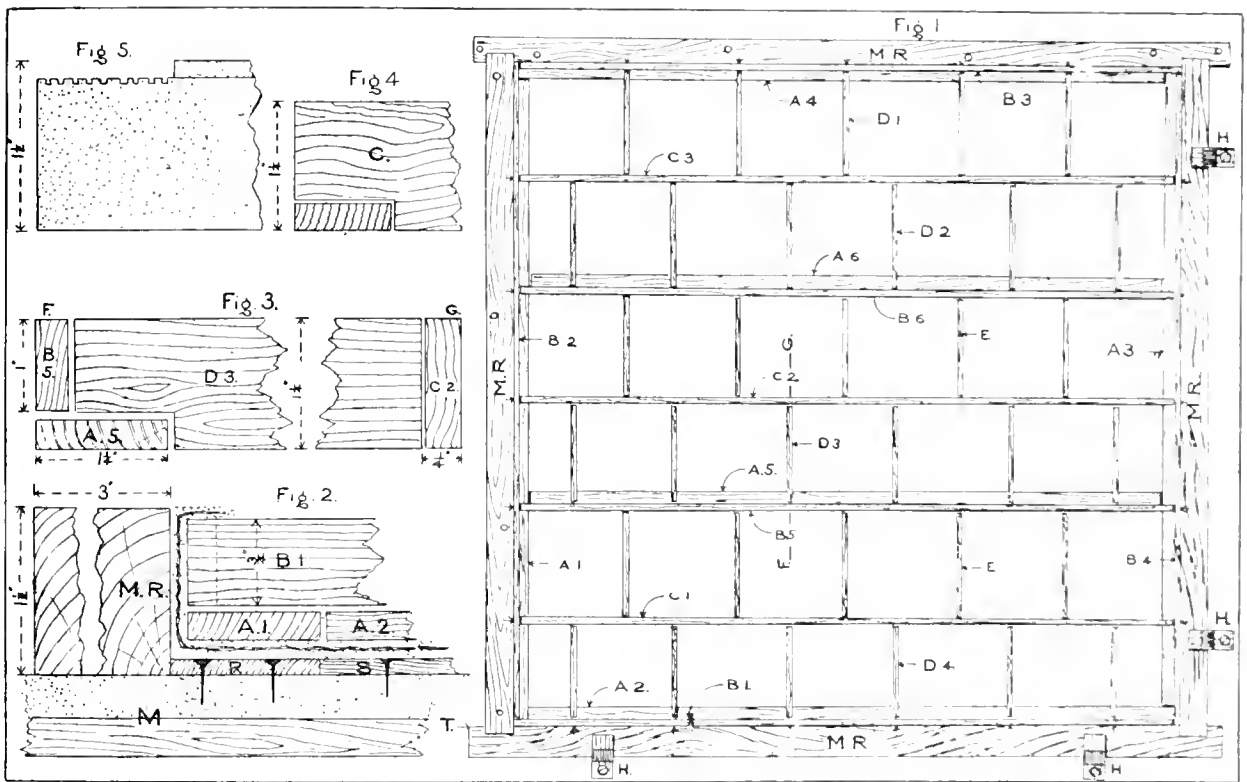

No. 141.—FINISHED FACE SLAB MOULD, SHOWING SLAB DURING THE PROCESS OF MAKING.

Various ways are used for placing laths in finished face slabs and other large fibrous casts. The main object is to obtain the greatest lateral and transverse strength and surface rigidity with the least amount of wood. The plan here adopted of using thin laths, and laying some on their flat for fixing, and the others on their edges for strengthening purposes, is the best up-to-date method, and renders the work not only strong and easy in fixing, but also light and flexible. This slab is 6 feet by 6 feet, and $1\frac{1}{2}$ inches thick at the edges, and it will be seen that the surface is divided by laths into sections about 1 foot square, and a few at the sides half that size. The positions of the laths should be marked on the mould rims, as shown. This saves time, and allows the various laths to be laid uniformly. Begin laying the lath from the sides of the mould, and work towards the centre. Two sheets of canvas are used for this class of work.

and they are laid and brushed as described for plain panels. This done, the laths are laid and brushed in their due rotation, as follows:—First, lay the four rim-fixing laths (A 1, 2, 3, and 4) on their flat, and close to the mould rules, then lay the two body-fixing rules (A 5 and 6) on their flat, and then lay the four frame laths (B 1, 2, 3, and 4) on their edge, and close to the mould rules, taking care to break the joints over the rim-fixing laths, as shown. The rim and body fixing laths are $1\frac{1}{4}$ inches wide and $\frac{1}{4}$ inch thick, and the frame laths are $\frac{3}{4}$ inch wide and $\frac{1}{4}$ inch thick. The decreased width of the latter is to allow for the thickness of the rim-fixing laths and the plaster and canvas. The lengths in all cases are made so that each lath will butt against the laths that traverse at the ends. The canvas margins are then turned over and brushed. Fig. 2 shows sections of the laths at the angle of the cast at T, Fig. 1. A 1 is the end section, and A 2 the side section of the rim-fixing laths. B 1 is the elevation of the frame lath. The end section of B 2 is indicated by the dotted lines, the plaster by the dotted surface, and the canvas by a thick and rough line. The letters on the sections correspond with those on the plan, Fig. 1. When the canvas margins are brushed, lay the two body-bearing laths (B 5 and 6) on edge on the body-fixing laths (A 5 and 6), and cover them with canvas strips, and press them well down on the surface. The two body-bearing laths are 1 inch wide and $\frac{1}{4}$ inch thick. The three rebated body laths (C 1, 2, and 3) are next laid on edge, canvased, and brushed. They are $1\frac{1}{2}$ inches wide and $\frac{1}{4}$ inch thick, and rebated at both ends so as to lap over the rim laths, as shown at C, Fig. 4. The four rows of rebated rim laths (D 1, 2, 3, and 4) are next laid on edge, and canvased and brushed. They are $1\frac{1}{4}$ inches wide and $\frac{1}{4}$ inch thick, and rebated at one end so as to lap over the flat fixing laths, as shown at Fig. 3. This is a section taken through FG on plan, Fig. 1. The letters and sizes correspond with those on the plan. The two rows of plain rib laths (E and E') are next laid, and canvased and brushed. They are $1\frac{1}{4}$ inches wide and $\frac{1}{4}$ inch thick, and square ended. The upper edges of the frame laths (B 1, 2, 3, and 4) and the body-bearing laths (B 5 and 6) are then made up and ruled flush with the mould rules or rims. This gives resisting points and bearings while the cast is drying and being fixed. The clips are then turned, the loose mould rules released, the cast taken off the mould, and then the rebated edges scratched with a sharp steel drag, to give a key for jointing. Fig. 5 is a section of an external angle of the cast, showing the rebated edges and keying. It will be seen that all the laths are $\frac{1}{4}$ inch thick, with the exception of the four frame laths, which are $\frac{3}{4}$ inch wide, and the two body-bearing laths, which are 1 inch wide. All the others are $1\frac{1}{2}$ inches wide. The slab surface is divided into three longitudinal sections by the fixing lath laid flat, and the bearing laths laid on them and on edge, which act as fixing and bearing points, the other laths being used for the general strength of the slab. Slabs that can only be fixed on the outer edges are constructed with thicker frame laths.

It may seem to the casual observer that there is a great quantity of wood required, but this is not so, considering that there are no plaster laths required for the ceiling or other surface. In fact, the total contents of wood in 1 superficial yard of slab do not amount to 1 cubic foot. There is also another matter in connection with this, viz., that there is a very small thickness of plastic material, the average thickness being only $\frac{1}{2}$ inch. As to the objection of expense, that must of course be estimated by the importance of the work. Like many other good and useful works, the cost of labour exceeds that of materials.

FIBROUS PLASTER LATHS LAID DIAGONALLY.—Laths laid diagonally in finished face slabs, or other fibrous plaster work, render it rigid and strong. The laths are laid on edge, therefore they can also be used as fixing laths, as well as doing duty as body laths. This is a more simple

and cheaper way than that given for finished face slabs. This diagonal system of laying laths will be found useful for most kinds of fibrous plaster work. The method of making diagonal lathed work is elucidated in the annexed illustration (No. 142). This shows the plan of a fibrous plaster panel, with the frame and diagonal body laths in position. The laths marked with A's are the frame laths, the B's are the long diagonal body laths, and the C's are the short diagonal body laths. The frame laths are $1\frac{1}{2}$ inches wide and $\frac{3}{4}$ inch thick, and in lengths and widths according to the mould, allowing the usual space at the end for canvas and plaster. All the body laths are made one width and thickness, viz., $1\frac{1}{4}$ inches wide and $\frac{1}{2}$ inch thick. The long body laths are cut to the necessary lengths, so that they may be equally spaced. The short body laths are cut equal to the spaces between the long diagonal laths. All these laths are laid on edge. The frame laths are laid first, and then the canvas margins are turned over and brushed. The long diagonal laths are next laid and brushed, their position and width apart being regulated by the marks which have been previously marked on the mould rims. The short diagonals are then laid and brushed. This method is more expeditious than the last-mentioned process, but it requires more wood, and the work is generally heavier, and not so strong. Care must be exercised when fixing this form of work that the nails or screws are accurately centred, so as to catch the centre of the laths. The method of placing diagonal laths may be used for many other purposes besides plain panels. The distance between the body laths may vary from 8 to 14 inches, according to the size and requirements of the work.

FIXING FINISHED FACE SLABS.—Finished face slabs are fixed by means of screws. They are countersunk, and the heads are coated with thick shellac to prevent rusting. The holes are then brushed with size water, and stopped with plaster. The joints are brushed with size water, and covered with canvas strips (about 2 inches wide), and brushed, then stopped with plaster and ruled flush with the surface with the aid of a wooden rule. After this they are smoothed with a margin trowel, or a small thin joint rule and a damp brush. Slabs made with a square flush

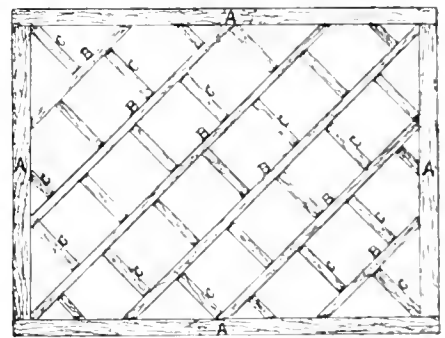

No. 142.—FIBROUS PLASTER PANEL, WITH DIAGONAL LATHS.

joint require great care when being stopped, and unless firmly fixed at the joints, and carefully stopped, the joints will show or crack when finished, especially if there is any overhead jarring. There is no fear of this with rebated joints. The canvas covering makes it impossible for the joints to open or crack, besides there is a sufficient body of plaster to make a smooth and fair joint. Another way is to cover the joints with small rib mouldings, thus forming a panelled ceiling, at a small extra cost. The slabs can be made to any shape, so that panelled ceilings or walls of any design can be constructed by this method.

GESSO SLABS.—Slabs as a groundwork for gesso work are made similar to finished face slabs. The first sheet of canvas should be laid near the surface, so that the key for the deep parts of the gesso may be easily obtained by scratching the plaster surface with a fine and sharp steel drag. This will fray the canvas, and give a pliant yet strong key for the gesso. The use of plastic slabs enables gesso, sgraffitto, fresco, or similar works to be done in the studio.

SGRAFFITTO SLABS.—Slabs for sgraffitto are constructed by first making a wood frame to the desired size. This is then lathed, or covered with strong wire-netting, or with metal sheet lathing. The frame may form the edges and ruling-off points, or rules may be temporarily fixed

on the outsides of the frame to give the desired thickness of plastic material. The frame is then plastered with any desired lime or plaster in the usual way.

FRESCO SLABS.—Slabs for fresco work are made as above, an equal and uniform suction being an important requisite for fresco work. Two sheets of wire-netting should be used, a close-meshed sheet being fixed first, so as to form a backing to regulate the thickness of the plaster work key that passes through the main sheet. This may also be done by temporarily fixing boards or a fibrous slab at the back of the main sheet. The upper surface is then laid with any desired lime or cement. This form of backing is also useful for sgraffitto slabs. The plastic materials being regulated at the back as well as the front surface ensures a uniform thickness, and therefore an equal surface suction.

PUGGING SLABS.—Pugging or deafening slabs are made in much the same way as fibrous slabs, their width being regulated according to the space between the joists, the length being 3 feet, and thickness 1 inch. For ordinary work they are composed of coarse plaster and fibre, sawdust, or any other similar aggregates, with a sheet of canvas in the centre. Fireproof pugging slabs are composed of coarse plaster gauged with fine slag, brick-dust, coke-breeze, or fine engine ashes, having a sheet of wire-netting in the centre. They are laid on wood fillets, previously nailed on each side of the joists, and bedded or stopped with coarse plaster gauged with size water. For best work, a double layer of slabs is used, the intermediate space being filled in with slag wool, or coarse plaster gauged with sifted breeze or ashes.

HARDENING FIBROUS PLASTER SLABS.—Several materials and methods are used for hardening neat plaster and fibrous plaster work, but they are too costly, slow, or unsuitable. After many experiments, I have found that the following solution gives the best results. For reference purposes it is named "Litharge Oil." It is made as follows:—

LITHARGE OIL is composed of 1 lb. of litharge (oxide of lead), 1 lb. of paraffin wax, $\frac{3}{4}$ lb. of resin, and 1 gallon of linseed oil. It is best made in an iron pot over a slow fire. The wax is melted in another pot and poured into the oil-pot. The litharge and resin, in a powdered state, is then put in, the solution being kept constantly stirred. It is allowed to cool before using, and when required, should be melted and applied hot on the work, which has been previously dried. The oil is laid on with a brush, and the work should be made warm, to allow the oil to penetrate into the surface, and to work freely. One coat is generally sufficient for ordinary purposes. When two coats are applied, the first is allowed to stand in a warm place for two or three hours. The second coat is then applied in a hot state. This process renders the work so hard that it will resist a nail. It becomes waterproof, and is effectively protected against any atmospheric changes. If the back of fibrous work is alone coated with this oil, the work will resist the action of saline acids and damp. It is also useful for indurating work intended for exposed positions. The work can also be painted and gilded soon after it is cool. This solution does not enter into any great chemical combination with the fibrous plaster, but being of a hardening nature, and filling up the pores, it hardens the work and prevents the action of moisture. It may be used with advantage for indurating ordinary plaster for various purposes.

DAMP-PROOF SLABS.—A cheap and ready method for rendering fibrous slabs damp-proof is done by brushing the backs once or twice with a solution of coal tar or pitch. Pitch, Stockholm, and coal tar are rendered more durable, damp-proof, and not so readily affected by heat, if mixed with fine brick dust, or ground lime. This solution should be well worked on the slabs with a hard stumpy stock brush. The process is effectual for slabs intended for damp or exposed positions.

FIBROUS PLASTER SIGN-BOARDS.—Another and novel use for fibrous plaster has recently

arisen in the manufacture of fibrous plaster sign-boards, letters, and advertisement tablets. There is a recent patent for fibrous letters and sign-boards, but fibrous advertisement tablets have been in use for the last decade for theatrical, patent medicine, and similar advertising purposes. The tablets are modelled, and contain raised figure and emblematical subjects; and are then painted, coloured, and gilded as required. They are lighter and cheaper than wood or iron, and more effective and durable than paper. Letters can be made in every conceivable type and size, and can be made singly, or on skeleton wire-work, to form clear and effective advertisements. Sign-boards are made plain for painting or writing on. They are also made with the letters standing out in bold relief, all in one piece, and being cast in moulds, they are perfectly true and uniform in shape, with a fine surface. They retain gold longer than wood, are light and strong, and perfectly weather-proof. They are made in a similar way to fibrous plaster panels, fine wire-netting being substituted for canvas, and tow for deep parts. They are usually made with a wooden frame round the edges, and a skeleton back frame for fixing purposes. A series of plaster moulds of letters is kept for stock purposes. These letters are laid on a moulding board to form the desired words. The joints are temporarily stopped. The frame is laid so as to form a fence, and then the main cast is made. Ornamental signs and letters are first modelled and then moulded from the clay with wax, jelly, or plaster, and then cast, thus producing an exact facsimile of the modeller's work. A ready way for making a sign-board with raised letters is done by fixing two thickness rules to the desired width on a bench, filling in the space with clay, ruling it flush with the rules, and then cutting out the letters down to the bench. When finished, the clay is coated with shellac and oiled. A wood frame is then laid on the surface and the cast filled in, using tow or perforated metal for the deep parts of the letters, and wire-netting for the main surface. The frame is so arranged with a wood fillet that the wire netting can be fastened to it. The cast is then dried, and coated with litharge oil to render it weather-proof. A mould frame made with fibrous plaster, and having an outside wood or metal member, may also be used for the above method. Fibrous signs may be supplemented with coloured glass, illuminated with inside lights, also by gas or electric light, and made in a variety of other ways to form a bold advertisement.

FIBROUS PLASTER BLOCKS.—These have been used in America and Germany for constructing partitions, ceilings, arches, and domes. The blocks are made in wood moulds, metal or plaster being used to form divisional parts. They are composed chiefly of strong coarse plaster. Reeds, sawdust, fibre, wood-wool, or ashes as aggregates are occasionally used. They are made in various forms and sizes, according to the intended purpose. For partitions, they are generally 3 feet long, 1 foot wide, and 2½ inches thick. Every three blocks of this size measure 2 yards, counting both sides, and each block weighs from 15 to 25 lbs., according to the size of the perforation, the amount and class of aggregate. They are made with round perforations extending longitudinally from end to end. This is effected by means of rods covered with brown paper to allow the rods to be withdrawn, or the rods are brushed with a thick solution of clay. The perforations may also be made by tapered rods. They are laid in the mould the reverse way, alternately, so as to give a uniform strength to the block. They are sometimes grooved on all edges to give a key for fixing purposes. They are also made with dowel holes for fixing purposes, the wood or metal dowels being inserted as the building proceeds. When they are fixed between iron or wood joists, the exposed parts of the joists are covered with wire-netting to give a key for the finishing coat. Domes or arches made in one piece or in large sections are generally composed with a skin of fine plaster, and backed with coarse plaster, and left with a finished face. No originality can be claimed for plaster blocks, the idea being taken from the stalactite ceilings of the Moors.

CHAPTER XIII.

REVERSE MOULDING.

REVERSE MOULDING—ITS USES AND TERMS—TO SET OUT A REVERSE RUNNING MOULD—TO MAKE A REVERSE CASTING MOULD FOR CORNICES—PANEL MOULDINGS—RIE MOULDINGS—PLAIN CAPITALS, DIMINISHED AND FLUTED COLUMNS AND PILASTERS, AND PLAIN COLUMNS—HOLLOW CORES AND COLUMN CASTS—REVERSE MOULDS FOR OVERDOORS.

REVERSE MOULDING.—Reverse moulding is an English invention, introduced about thirty-five years ago by J. McDonald, who was formerly foreman for Desachy; since then he has held an important post with Messrs G. Jackson & Sons, London. It is the natural outcome of fibrous plaster work, and derives its name from the simple reason that the methods used are the reverse of those which are generally employed for the formation of plaster and running moulds. The running mould for forming a reverse casting mould is cut from the inner profile of a design or moulding, being the reverse way used for an ordinary running mould, which is cut from the outer profile of a design. A casting mould made by the reverse method requires no model to mould from, but is run direct with a reverse running mould, which is the contrary way employed for an ordinary casting mould taken from a model or moulding piece. A reverse piece mould for a cornice is run in one operation, while an ordinary piece mould is formed by hand from a model which requires complicated manipulation. The uses of and the improvements in reverse moulding during the last two decades have developed in a variety of ways. The most important improvements are due to one Tom Sweeney, formerly an employé of G. Jackson & Sons.

The art of reverse moulding is more expeditious than ordinary piece moulding, and a round saving is effected in general fibrous plaster work, but it is not applicable for figures or foliage. It is adopted advantageously for casting concrete. Being comparatively new, its practice is limited to a few. There being no general terms to distinguish the various stages and processes of the work, it is necessary to define the nomenclature adopted, and describe the general process, before describing the individual parts.

The "ground line" drawn on the design of the intended moulding represents the ground or bench line, and is used for setting out the form and position of any required loose pieces, as well as the width of bearings for the nib and slipper of the running mould. The "square edges," or "striking off" edges, forming the rim of the casting mould, are the same as the ceiling and wall lines, and are usually square with each other. A "loose plate" is a plate temporarily screwed on to the running mould to form a bed for a "loose piece," which is a movable portion of the casting mould. It is made where any member, or part of a member, is undercut, or which would prevent the cast from drawing. The loose piece comes with the cast when the latter is taken out of the mould. It is then taken off the cast, and replaced in the mould. If a loose piece should get broken when taking it off the cast, the pieces can be put in their places in the same manner as a piece mould, and any defects stopped with clay or plaster, and the seams cleaned off the cast.

Large loose pieces are made lighter and stronger by inserting canvas strips in their centres while being run. As there is little or no swelling in a fibrous cast, the loose piece is easily removed by gentle tapping with a mallet. The core is a bracket made of wood, brick, or other rough material. It is used in large work to save plaster, and prevent swelling. The casting mould is simply termed "the mould" to distinguish it from a running mould. Committing the foregoing terms to memory will enable the method of setting out, and making of reverse running moulds, to be more readily followed, and afterwards put into practice. The accompanying sketches illustrate the method of making a reverse running mould, and casting moulds for various purposes. As the foundation of reverse casting moulds lies in the setting out of the running mould, a section of the running mould for each casting mould, and also a description of setting out one for a cornice casting mould, is given.

TO SET OUT A REVERSE RUNNING MOULD.—The annexed illustration No. 143 elucidates the method of setting out a reverse running mould for a cornice. Take Fig. 1 as the given profile of a cornice to be produced in fibrous plaster or cement. As already explained, the first

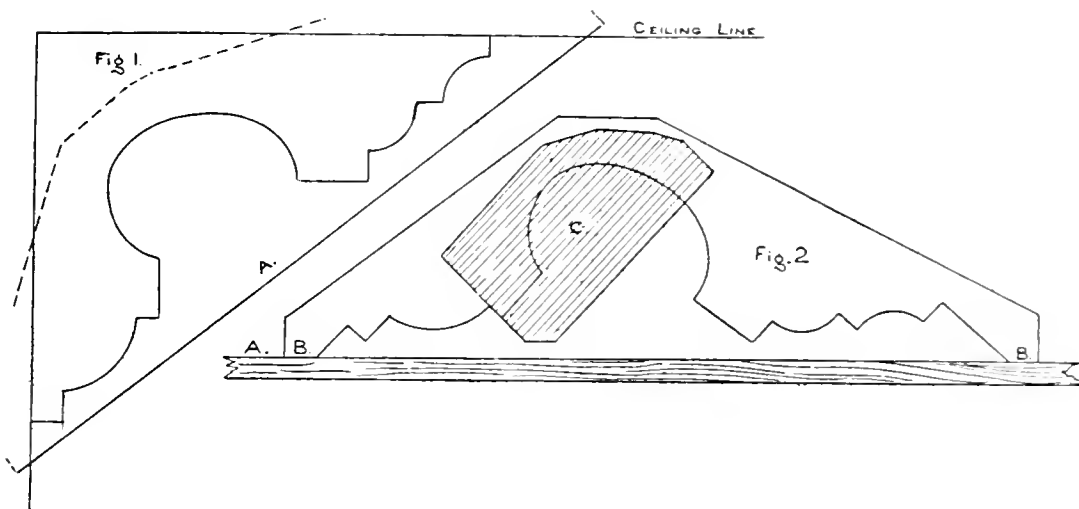

No. 143.—TO SET OUT A REVERSE RUNNING MOULD FOR A CORNICE.

thing required is the ground or bench line (A), taking care to leave sufficient thickness between the most prominent points of the moulding and the ground line. This thickness is the body of plaster which constitutes the casting mould, and should not be less than 1 inch thick, because if less, the plaster dries, and is apt to lift from the bench. When forming the ground line, it must not be forgotten to have a sufficient depth of the ceiling and wall lines, as they form the rim or striking-off edges of the casting mould: also continue the line across the wall and ceiling lines to allow for a bearing for the nib and slipper of the running mould, as B, B on Fig. 2. After having settled the proper position and length of the ground line, the form of the plate of the running mould is then set out to the ordinary width, beginning at one end, and continued to the other end, as shown by the dotted lines which spring from the ground line (for want of space this line is broken). The space between the dotted line and the inner section of the cornice is the plan of the mould plate, and of course is precisely the same in form as the section from B to B in Fig. 2. It may here be remarked that, in order to keep the architect's drawing clean and free from the pencil lines necessary for setting out purposes, a tracing should be taken from the original drawing, and

transferred to ordinary white paper (wall lining paper is good and cheap for this purpose), and on this the section of the plate and the loose piece and its plate can be freely set out.

Fig. 2 shows the section of the mould plate, and on it the loose piece plate (c). The face of the bench (A) is the same as the ground line (A) in Fig. 1. It will be seen that the undercut formed by the cove member would prevent the cast from drawing out of the casting mould. This difficulty is got over by using a loose piece, as shown. When setting out a loose piece, care should be taken that it is cut to draw in the same line as the greater portion of the members, as expressed by the longest side of the loose plate. Loose pieces should also be made with the joints in flat parts of a member, so that they may be easily cleared off. For enriched cornices they should (when practicable) be made in the bed of an enrichment, as any unevenness in the mould at these parts can be easily made good, and the seam in the cast covered with the enrichment casts. In this example one joint is made near the centre of a member (the cove), and the other is made in a line with a straight part of a member (the fillet). The latter way leaves the joint of the loose piece at an arris, and unless the loose piece is closely fitted for every cast when casting, it will leave a seam at an arris of the cast, which requires considerable care and skill to clean off. A seam on or near an arris is more difficult to clean off or make good than one on a flat surface. This form of joint, although not so good as the first, is given to show what is sometimes used for special

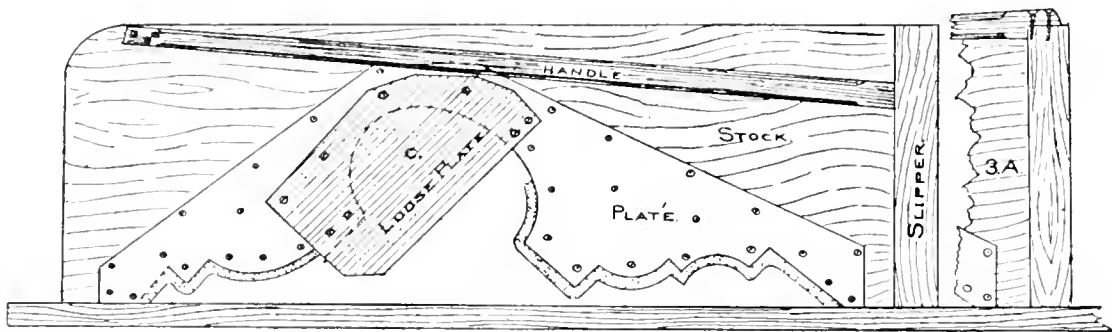

NO. 144.—REVERSE RUNNING MOULD FOR A CORNICE CASTING MOULD.

purposes. It is better than forming one on a small round member, such as the quarter round below the present joint, as shown in the sketch, or a small bead. It has one advantage, namely, that a joint on the under part of a member is not so noticeable as one on an upright or vertical member. Loose pieces should be made large and strong, so as to lie firm and steady in their beds, as well as to stand the frequent moving and handling when casting, but not so heavily as to overweight the cast. Sharp angles in the bed of loose pieces should be cut off, as shown below C. This allows the bed to be easily cleaned out, and prevents a sharp edge of the loose piece, which would wear off, and cause dirt in the joint. These precautions tend to secure a close and even fitting joint after each cast. The loose-piece plate should always be made large enough to lie well over the stock of the running mould to give a good bed for fixing.

TO MAKE A REVERSE CASTING MOULD FOR A CORNICE.—Having set out the mould plate, the position and form of the loose piece, and cut the plate for the loose piece, the whole is horsed. Running moulds for reverse casting moulds require to be more strongly "horsed" than ordinary running moulds for lime or cement work. Reverse casting moulds are generally composed of neat plaster, therefore the running mould should be stoutly horsed, to enable it to resist the force of the plaster when it begins to swell or set while being run. The stock should be

from $\frac{3}{4}$ inch to $1\frac{1}{4}$ inches thick, according to the size of the proposed mould. The strength of the running mould is greatly increased by fixing two handles (one at each end of the slipper from the slipper to the nib end of the stock. The fixing point at this end should extend as far as the outer member of the profile. Two handles allow two men to work freely together, one to push the mould along, and the other to push and hold the nib of the mould down, so that the mould will run steady and true, avoiding humps in the work. For extra wide mouldings, the handles should be fixed on the top of the slipper, as shown at 3 A in annexed illustration (No. 144). This method is stronger, and gives a better grip for the workers, than if fixed on the inside of the slipper, as shown by the section of the running mould in the same sketch. One handle is generally sufficient for small work. There are two methods used for running a reverse casting mould which requires a loose piece. By the first and original method, the main moulding and the loose piece are run in two distinct operations; and by the second method, the main moulding and the loose piece are run in what may be practically termed one operation. For example, take the section of the running mould (illustration No. 143) of the foregoing cornice, which will illustrate both methods. For the first method the mould plate is cut into three parts; the first and third parts are those which run the main mould, and the second or middle part is that beneath the loose-piece plate, or in other words, the mould plate is cut in an exact line with the side joint of the loose plate. The three parts are then fixed on the stock exactly in the same position as it would be if in one piece. This done, the loose plate is fixed over the second part of the mould plate, and then the moulding is run in the usual way. After this, the first and third parts of the mould plate, also the loose-piece plate, are taken off, thus leaving the second part of the mould plate on the stock, and with this mould the profile of the loose piece is run, taking care to first shellac and oil the bed of the loose piece and also the main moulding, to allow the loose piece to be easily taken off, and any plaster splashes that may fall on the main moulding, while the loose piece is being run to be cleaned off. It will be understood that the running mould must be muffled with plaster before the moulding is run, and after the moulding is roughed out, and the plaster swollen to its full extent, the muffling is taken off, and then the moulding run off or finished. This allows the plaster core to swell fully, and the moulding to be run off freely.

The second method is employed for the present casting mould, and the process is as follows:—As already mentioned, the illustration (No. 144) shows the section of the reverse running mould for running a casting mould for a cornice, as set out in the previous illustration. This section shows the loose plate and loose-piece plate screwed on the stock, also the handle and the end section of the slipper. The names of the various parts are shown on each part. The loose plate forms the bed of the loose piece (c). The dotted line beneath the loose-piece plate indicates the continued profile of the main plate, which, of course, is also the profile of the loose piece. The plaster muffling is indicated by the dotted parts outside the profile of the mould plate. In order to make a true and sound joint between the main and loose parts, about $\frac{1}{2}$ inch at each side of the loose piece is left unmuffled. The moulding is roughed out, and then the muffling is taken off, and the finished surface run off.

Fig. 1 in the annexed illustration No. 145 shows the section of the casting mould when run with the muffled mould, leaving a finished surface at the bed of the loose piece (c), and a finished part at the joints of the loose piece, the dotted lines indicating the profile and thickness of the fine plaster used for the finished surface. The bed of the loose piece is next shellaced and oiled, and then filled in, and the rough surface of the mould laid with fine plaster. The whole is then run off in one operation. Fig. 2 shows the section of the complete mould with the loose piece (c)

and the finished surface. The rough core and the thickness of the finished surface (with the joints formed by the unuffed part of the running mould) are indicated by a rough dotted surface and a fine dotted surface respectively. By comparing this figure with Fig. 1 and the section of the running mould, the whole process will be seen in a clearer light. With regard to the filling in of the mould, the cast must not protrude beyond the dotted lines that spring from the rims or "striking-off" lines, as shown in Fig. 2. The striking-off lines represent the wall and ceiling lines, and any projection beyond these lines would prevent the cast from being fixed plumb, level, or

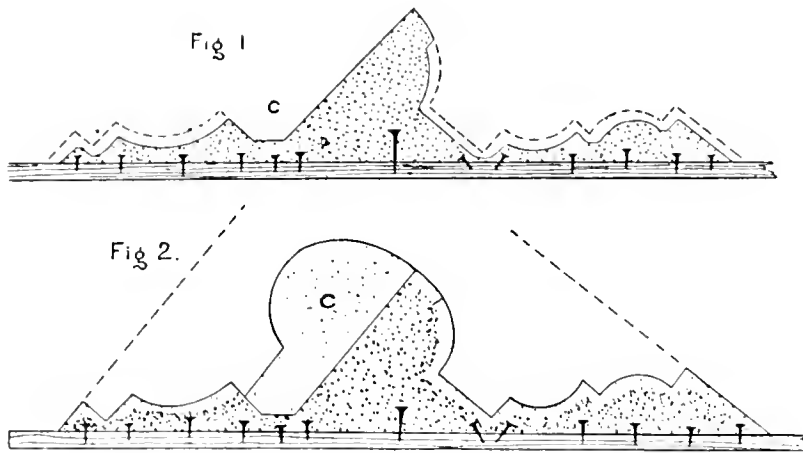

NO. 145.—REVERSE CASTING MOULD.

Fig. 1.—Section of Mould when run with the Muffled Running Mould. Fig. 2.—Section of Casting Mould with Loose Piece.

square. In some instances, cornice casts are fixed on the ceiling joists and wall plugs. Where this occurs, an allowance must be made for this when setting out the running mould. It will be seen that the formation of a reverse running mould for a plain moulding is simple, and when the method of setting out loose pieces is mastered (some mouldings require several loose pieces), their use for a variety of purposes will suggest themselves to the thoughtful plasterer.

TO MAKE A REVERSE CASTING MOULD FOR PANEL MOULDINGS.—Illustration No. 146 elucidates the method of making a reverse casting mould for sunk panel mouldings for beams,

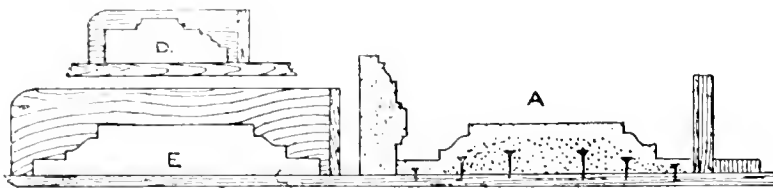

NO. 146.—REVERSE MOULDS FOR PANEL MOULDINGS.

arches, &c. The section of the sunk panel casting mould on the running board, with the fixing nails to prevent the moulding from lifting, is shown at A. One side of the mould is shown with a plaster piece used as a side piece if the side or front is moulded. The other side shows a board standing on edge and secured with a rule on the flat as used when a plain side is required. E is the section of the running mould for the sunk panel mould at A. The section of the running mould for the moulded side is shown at D. This moulded side is sunk and raised

to show that the same method of forming the running mould applies to both. If the sunk panels are required for an arch, the mould pieces must be run on a saddle made to the desired curve or radius. For circular panels on flat surfaces the mould pieces are run from circular templates, or by fixing a radius rod to the running mould. The running moulds are set out as already described. The stock, which, in this case, also represents the profile of the plate of the running mould, is indicated by horizontal irregular lines, and the slipper by vertical irregular lines. These remarks also apply to the running moulds in the following examples of reverse casting moulds.

TO MAKE A REVERSE CASTING MOULD FOR RIB MOULDINGS.—The annexed illustration

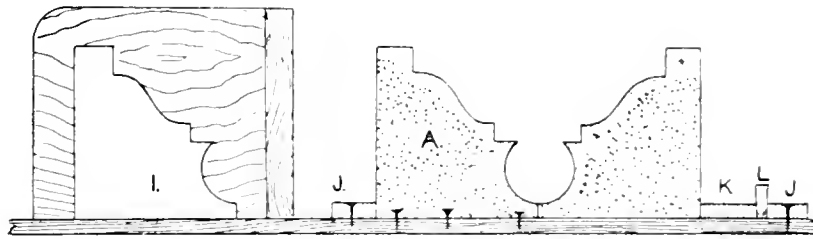

NO. 147.—REVERSE MOULDS FOR RIB MOULDINGS.

(No. 147, shows sections of the running mould I, and the casting mould A for rib mouldings. There are two methods of constructing the casting mould. By the first, one-half of the mould is run as a fixture, as shown by the fixing nails, and the other is run as a loose piece and held in position by the side rules, as shown by their sections. J, at the left side, is a fixed rule, which is only used if both pieces are movable. J, at the right side, is also a fixed rule, and is used as a stay for the wedge L, and K is a movable rule placed along the side of the mould. This method is better than using wedges between the fixed rule and the mould, as the wedges, bearing only at intervals on the mould, are apt to break it while being forced home. Again, if the plaster is hot,

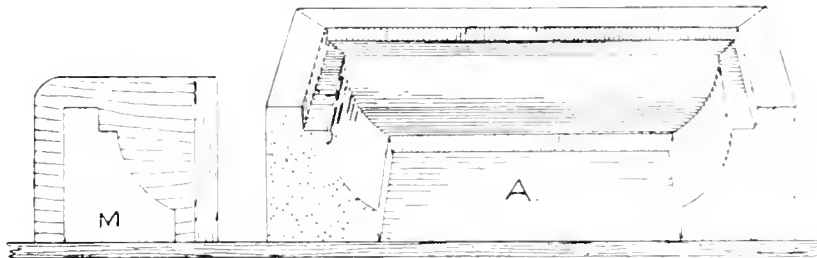

NO. 148.—REVERSE MOULDS FOR PLAIN CAPS.

or liable to swell or twist, the unequal pressure, or rather the pressure at certain parts, causes the mould to twist at the intervals, whereas the movable rule has a bearing the whole length of the cast. Another advantage is, that should the half mould get broken, the rule will keep it in position. When the mould is filled in, remove the wedges and the side rule, then draw the half mould with the cast up to the fixed rule, and the cast can be easily taken out. By the second method, both sides of the mould are made as loose pieces, and held in position by side rules, as shown. Another way to hold the pieces together is to dispense with the wedges and fixed rules and use clips, as described for "slab bench-moulds" page 369. If circle ribs are required, and their length does not extend beyond their diameter, the inner half is run first, and made as a fixture.

The outer half is run as a movable piece. If a full circle or more than half a circle rib is required, the casting mould is run the full length required, and then cut into sections, so as to form a piece mould to allow the pieces to draw easily off the casts.

TO MAKE A REVERSE CASTING MOULD FOR PLAIN CAPITALS.—The figures in the annexed illustration No. 148 show sections of the running mould (M) and the casting mould (A) for a plain moulded capital. In making the casting mould, first run a sufficient length of moulding to form the front and sides of the mould, then cut it to the required lengths and mitres, and place them on a moulding board, as shown. The mould pieces are held in position as described in the previous example. Casting moulds for circular capitals commonly called "caps", also for square or other shaped piers and copings, are constructed by the above method.

TO MAKE REVERSE CASTING MOULDS FOR DIMINISHED FLUTED COLUMNS AND PILASTERS.—The annexed illustration No. 149 elucidates the method of making reverse moulds for diminished and fluted columns and pilasters. There are divers ways in which reverse casting

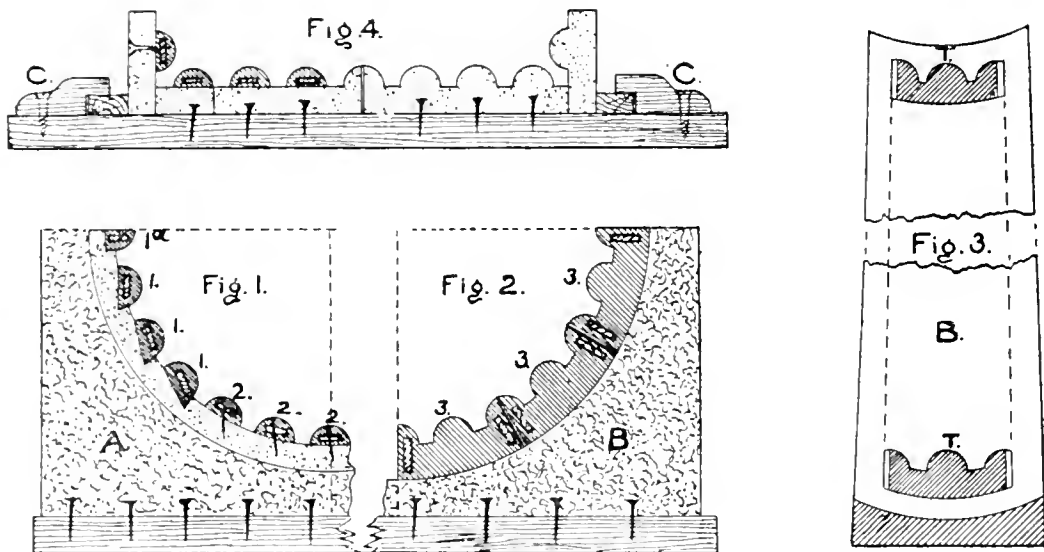

NO. 149.—REVERSE CASTING MOULDS FOR DIMINISHED FLUTED COLUMNS AND PILASTERS.

Figs. 1 and 2.—Sections of Reverse Moulds for Columns. Fig. 3.—Plan of Ground for forming Flutes.

Fig. 4.—Section of Reverse Moulds for Pilasters.

moulds for diminished fluted columns can be made. The two methods here given—introduced by the author—are simple in construction, and accurate in production. Fig. 1 shows the section (one-half) of the reverse casting mould for a diminished and fluted column. The dotted lines indicate the top and centre of the mould. It may here be mentioned that two casts are got out of this mould, and screwed together, to make the complete column. The body of the mould, of which the dotted surface (A) is one-half of the section, is first made. This is done by cutting a reverse running mould of the necking, with about 2 inches of the shaft, and another running mould of the first fillet of the base, with about 2 inches of the shaft. A part (a little more than half the circumference) of the necking and base mouldings is run, and each is then cut to the true half. They are then fixed on a stout moulding board or bench (similar to T and T in Fig. 3), so that a man can work on each side of the mould. The necking and base moulds are fixed a distance apart, equal to the length of the proposed column, taking care that they are linal with each

other, and level at the upper or jointing edges. A board is fixed at each side as a fence. The intermediate space is then cored out with boards or brickbats and plaster, and the surface made up with plaster, and ruled with a diminished rule. This rule must be cut to the reverse contour to that described for forming diminished column *in situ*. The flutes are next formed. This is done by first setting out the positions and forms of the flutes on the ground of the mould. A solid one, from which the mould for the other flutes is taken, is made in the centre of the mould. This flute will allow the half-column casts to draw; therefore it is made permanent. The ground should be well keyed, and a few nails driven in, and left projecting, to give a further key for the plaster with which the flute is formed. Templates are then cut to the size of the lower and upper diameter of a flute. They are then temporarily fixed on the body of the mould at the end of the flute lines. The intervening space is then filled in with plaster, and ruled with the diminished rule. The templates are then removed, and the circular ends of the flute formed by hand, using the circular end lines on the ground as a guide. A plaster mould is then taken from this, and the required number of fibrous casts are got out, and fixed on the ground of the mould. When casting the flutes, place a lath in the centre of each (as shown by the sections) to strengthen the casts, and allow for fixing to the body of the mould. It will be seen that only five flutes will draw, viz., the centre, and two on each side. Provision must therefore be made to allow the flutes to draw in the shape of loose pieces. Two different methods of making and fixing are shown. For the first method sinkings are made in the ground to receive the flutes, and hold them in position, as shown at 1, 1, 1, and 1a. The sinkings are first cut to a uniform depth, keeping the ground at an angle that will allow the movable flute to draw with the cast. A single flute is then made on one of the rebated grounds, and moulded and cast as described for the centre flute, and then placed in their respective positions. Should any difficulty occur in cutting the sinkings uniformly, each flute may be formed on its own bed. The half flute 1a requires a deeper sinking, as shown, to act as a counterpoise for the projecting weight. It will be understood that the bed of each flute is shellaced and oiled before the flute is made. The same method is employed for the other half of the mould. It will be seen that these sinkings allow the flutes, which are undercut on the lower sides, to draw with the cast. When the cast is taken out of the mould, the flutes are taken off and replaced in their respective positions. An old way is to hold the flutes in position with pegs or French nails, which are fixed through the flute and into the body of the mould at an angle to allow the flutes and nails or pegs to draw with the cast. For small work the laths in the flutes may be omitted. An extra layer of canvas or tow will be ample for the requisite strength.

Fig. 2 shows the section of the casting mould as made by the second method. For this method a reverse piece mould is made, each piece consisting of a whole flute, two fillets, and two half flutes, as shown at 3, 3, and 3. For this method a different section, having a larger diameter, is required for the body of the mould (B), so as to allow for the extra thickness of the pieces. This is formed by first cutting two templates, one to fit the upper, and one to fit the lower diameters of the shaft, taking care to allow $1\frac{1}{2}$ inches for the thickness of the pieces. They are then fixed the desired width apart, and the intermediate space filled in and ruled off with a straight-edge, as shown by the section of Fig. 3. Two templates are then cut to the upper and lower sections of the combined flute, fillets, and half flutes. They are then fixed on the ground of the body of the mould (as shown by T and T in Fig. 3), and the intermediate space is filled in with plaster, and the upper surface ruled off with a diminished floating rule, and the two sides ruled off with a straight-edge. The sides may also be formed by temporarily fixing a board on each side of the template (as indicated by the dotted lines in Fig. 3) to act as a fence. Care must be taken that the sides are

straight, and that the surface or profile is formed with a diminished floating rule, so as to form a true and uniform arris. The model of the flute may also be run with the aid of a hinged running mould. The ends of the flutes are then formed by hand, and the model moulded and cast as before. For large work laths (as shown) are inserted to give strength. The casts are easily extracted by the aid of three strips of dry canvas, which are laid in channels formed in the body crosswise (one near each end and one central). The strips are cut long enough to lay on the channels under the flutes, and over the sides of body, so as to afford a grip when extracting the cast. The strips also prevent the flutes falling off the cast.

Fig. 3 shows a plan and section of the ground, with the joint lines of the flute and fillet piece set out. T and T are the upper and lower templates in position on the ground, ready for the model of the piece to be filled in at B. This also illustrates the method for making single flutes.

Fig. 4 shows a section for a reverse mould for casting pilasters. The flutes may be worked solid by the aid of templates, as described for the columns, as shown on one-half of the section, or they may be cast in fibrous plaster, and fixed, as shown on the other half. The sides are held in position with rules and clips, as shown at C, C. The method of making and using the clips is the same as described for slab bench moulds in Chapter XII.

TO MAKE A REVERSE CASTING MOULD FOR PLAIN COLUMNS.—Illustrations Nos. 150 and 151 elucidate the method of making a reverse casting mould for plain columns, also for making

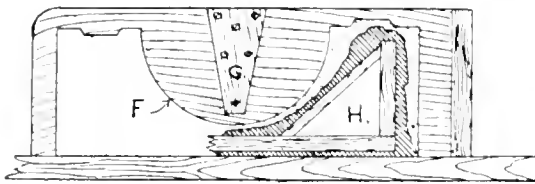

NO. 150. REVERSE RUNNING MOULD, FOR REVERSE CASTING MOULD FOR PLAIN COLUMN.

hollow moulds and casts. No. 150 shows the section of a reverse running mould (on a running board) for running a casting mould for a plain column 4 inches diameter of any desired length. F is the profile of the mould, G is a wood cleat screwed on the stock to strengthen the deep part, and H is the section of a hollow core, as used for hollow moulds and casts. Great care is necessary when cutting the mould plate to ensure true fitting of the male and female joints or

joggles, as shown in the section of the casting mould on No. 151. This is best done by first roughing out the profile on a sheet of zinc, then cutting it through the centre—taking care to cut it true, so that the two halves will fit close at the joint when fixed on the stock—thus allowing both sides to be placed in a vice and be filed together in one operation, so that both sides of the profile will be exactly alike. This also enables the joggles to be fitted accurately. This method of cutting the plate through the centre and filing the halves together will be found useful when making mould plates for equal-sided mouldings, such as rib mouldings, &c. In making a casting mould, say for a column 4 feet long, run a full 8 feet length of moulding, and cut the piece in two, then place one on top of the other, binding them with hoops to keep them together while casting. This casting mould, as also the other reverse casting moulds here illustrated, may be called a "run plaster piece mould," as the pieces are run instead of being made by hand, as is done in ordinary plaster piece moulds. The joggles in this example are also run instead of being made by hand. This is a method which I have introduced and used advantageously. The joggles being run with the mould piece are termed "run joggles," but while they prevent the mould pieces from moving sideways, they will not prevent the pieces moving lengthways, and as any displacement of the pieces while casting would cause distorted cast work, this is effected by converting parts of the run joggles into "stop joggles" to hold the pieces both ways. Stop

joggles are made by cutting about 2 inches off each end of the male joint, and then "stopping" a corresponding length in the female joint. The stopping is done by cutting off the desired length at both ends of the male or raised joint, then oiling the cut parts to prevent cohesion, and then placing this mould piece on the other, and filling in the female or sunk joint at the ends with plaster, which are previously keyed and wetted. Intermediate "stop joints" are made by cutting off a part of the male joint where required, then cutting a hole through the female joint to allow the plaster to be poured in to form the stop joggle.

At one angle of the section of the casting mould a triangular-shaped block of wood is shown. This is used as a core in large moulds to save materials and lighten the mould while casting. Two blocks, one at each side, are fixed on the running board before the mould piece is run. After this, the moulding is taken off, thus forming the splayed angles, one of which is shown on the section of the mould. The fine and coarse dots on the surface section indicate fine and coarse plaster. It does not follow that because there are no loose pieces in the mould, the running mould should not be muffled. When the moulding is roughed out with a muffled mould, it allows the plaster to swell before the finished face with fine plaster is run, so that the moulding can be run with greater ease and accuracy. It also allows for the use of coarse plaster. Fine plaster for a large mass is an unnecessary waste. It is sometimes required that the cast should be of a given thickness, so that it will fit a structural iron column, or that the inner surface should be of a certain profile. Both these forms are obtained by fixing templates on the ends of the mould to act as ruling-off points, or as guides for working straight or curved rules. The section of a quarter of a template for this purpose is shown at T, on illustration No. 151.

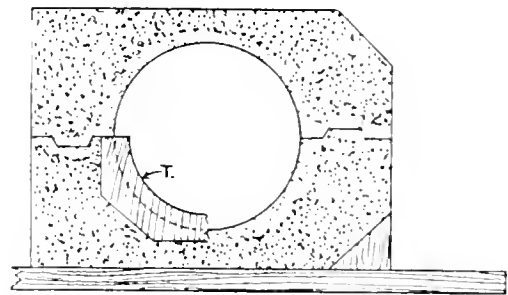

NO. 151. — REVERSE CASTING MOLD FOR PLAIN COLUMNS, SHOWING RUN JOGGLES.

HOLLOW CORES. — The method of making hollow cores is elucidated by illustration No. 150. H shows the section of a hollow fibrous plaster core. This method is more often adopted on the score of economy for permanent purposes than for temporary works. It is useful, however, for extra large moulds that have to be moved about, and while it saves about one-half of the weight of ordinary solid work, it gives more than double the amount of strength. The method of making is as follows:—The wood frame is first made and fixed together before being used. It should be made somewhat less in diameter than the actual size, so as to allow for plaster, canvas, and in the case illustrated, for the fine finishing coat of plaster. After the frame is made and fitted, a coat of "firstings," and then "seconds," and canvas is laid on the bed, and the frame is placed in position, allowing plenty of canvas for the two ends to overlap the frame. Another strip of canvas is then brushed over the joint or uncovered place, as for fibrous plaster. Before the stuff is set, the muffled mould is passed backward and forward, to see that there is no excess of material. The surface should be left as rough as possible, so as to give a key for the finishing plaster coat. A little teased tow stuck into the fibrous work while soft, and left loose on the surface, affords a good key. The finishing coat should be laid and run while the core is green. If the gauged stuff is brushed on, a better key is obtained than if merely laid with a trowel, especially when following the different curves and deep parts of a moulding. The cross lines round the frame represent fibrous plaster, and the part with the dotted surface the fine plaster used

for the finished surface. This method can also be used for some parts of hollow fibrous plaster or for ordinary plaster work.

HOLLOW COLUMN CASTS.—If hollow casts of columns in cement are required, stand the mould on end, then place a tapered wood core upright in the centre, secured at the bottom end by inserting the end into a socket which has been previously made in the wood ground. The core is easily removed after the stuff is set by tapping with a heavy hammer. The gauged cement is poured in from the top and rammed home with the aid of a piece of rule having the sharp arris taken off, or the end of the rammer covered with a piece of felt. This is to protect the surface of the mould. If a hollow plaster cast of a column or other circular work is required, the mould, if large or heavy, is rolled on the bench or slung with ropes from the roof, and rolled or turned round

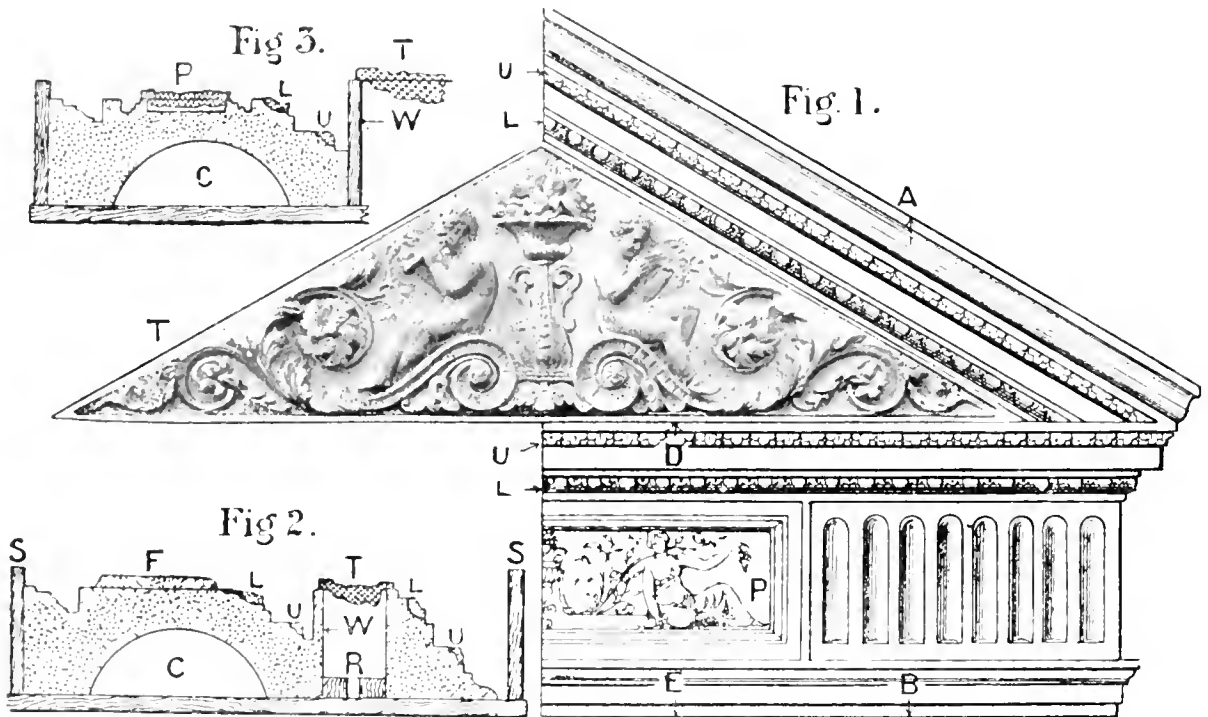

NO. 152.—FIG. 1.—ELEVATION OF OVERDOOR, PALACE CLUB, LONDON, DESIGNED AND MODELLED BY WM. MILLAR, 1875.

FIG. 2.—SECTION OF REVERSE CASTING MOULD, THROUGH A B. FIG. 3.—SECTION OF REVERSE CASTING MOULD, THROUGH D E.

while the plaster is setting. If fibrous casts are required, one-half of the mould is filled in the way already described, and having a wood lath at each edge. The joints are kept flush with the edges of the mould, and when two casts are got out, they are placed evenly together and screwed through edge laths, and further secured by passing a long strip of canvas previously soaked in plaster. The wet canvas is pulled backwards and forwards over the joint, and pressed on by the aid of a stump of a brush fixed on a wood lath and worked from each end of the mould. The mould is then turned over, and the other joint treated in the same way. Another way, useful for white cement and fibrous plaster work, is to make a rough fibrous plaster core and place it in the mould, and then fill in the space between the core and the mould with plaster or white cement as required. The core must be "green" as well as rough, so that the surface material will adhere to the core. When the material is set, the mould is released, and the cast with the core in one piece extracted.

TO MAKE REVERSE CASTING MOULDS FOR OVERDOORS AND PEDIMENTS. — Illustration No. 152 elucidates the method of making a reverse casting mould for an overdoor and pediments. Fig. 1 shows the half elevation of a pedimental overdoor 6 feet long in fibrous plaster, as carried out at the Palace Club, London. This overdoor was designed and modelled by the author, and the reverse mould was made by C. Handwell. In order to render the method of making the mould more clear, the various parts of the overdoor, as shown on Fig. 1, are described first. A is the inclined cornice, and D to E is the horizontal cornice. The latter includes the fluted frieze (with the enriched panel P), and the architrave. The upper and lower enriched bed-moulds, U and L, in the inclined cornice, are, of course, the same in design as the enriched bed-moulds U' and L' in the horizontal cornice. The enriched panel, T, is the tympanum of the pediment. With regard to making the reverse mould, first set out the plan of the overdoor on a moulding board which would be similar in form to the elevation. It is not necessary to draw all the lines of the mouldings, the width of the inclined and horizontal cornices will be sufficient. Extra lines representing the width of the sides or rims of the run reverse casting moulds of the cornices must be made on both sides of the width lines, so as to form fixing points when the various parts are placed together. If the sides



NO. 153.—PANEL FOR OVERDOOR, PALACE CLUB, LONDON. MODELLED BY WM. MILLAR, 1875.

are formed with boards the extra lines are not required. The present example shows run plaster sides and wood sides, to illustrate both ways. The reversed running moulds for the inclined and horizontal cornices are cut and "horsed," as previously described, but taking care to allow for a reverse bed for the enrichments, also a bed for the enriched tympanum, as these enrichments are cast separate and laid in the main mould in a similar way as described for "Cornices with Bedded Enrichments" in Chapter XII. Having run the reverse casting moulds of the cornices, cut them to the required angles or mitres and lengths, and lay them on the moulding board according to the plan. Three rules are fixed to the form of the tympanum on the board, to hold the two parts of the inclined cornice and the horizontal cornice moulds in position, and prevent them moving inwards. They are prevented from moving outwards by means of rules and wedges, as already described. The flutes are formed by making a reverse model of a flute, then moulding it and casting as many as required, and then fixing them on the frieze. A reverse running mould for the panel moulding at P is made. Then a length of reverse casting mould is run and cut to the desired angles, and then they are let into the frieze and the mitres stopped. The returned ends of the horizontal mould being upright, separate pieces must be cut to fair external mitres and square ends.

The returned ends of the inclined cornices are set out and formed as described for raking mouldings in Chapter VII. Fig. 2 shows the section of the casting mould, as from A to B on the elevation, Fig. 1. The section shows the various parts of the mould, also the fibrous casts of the enrichments. R are the rules fixed at the inside of the tympanum, which prevent the inclined and horizontal moulds from moving inwards. The inclined and horizontal moulds are indicated by dotted surfaces. C is a cored part in the horizontal mould to save plaster. F is the side section of a flute. S and S are boards which form the upper and lower sides of the outside members. U L and U L are sections of the two enrichments in the inclined and horizontal cornices, which correspond with U L and U L on the elevation at Fig. 1. T is a section of the enriched tympanum. These enrichments being composed of fibrous plaster are indicated by crossed diagonal lines. The sections and positions of these enrichments are given, to illustrate the method of casting the complete overdoor, this being the form of the mould ready for filling in. Fig. 3 shows the section of the reverse casting mould, as from the darts at D E on the elevation, Fig. 1. This has the same section as the horizontal mould at Fig. 2, with the exception that a section of the panel moulding, with a sinking for the panel enrichment, P, is shown. A small part of the enriched tympanum, T, is shown. The enrichments U L and U L are the same as in Fig. 2. An enlarged view of the panel, P, is shown on illustration No. 153. The top member of the horizontal mould in Fig. 2 is formed in plaster, and is run with the main part of the run mould, as shown at W. This way is only adopted where there is an ample splay or weathering on the top, otherwise the cast would not draw. The best way for this purpose is to make a side piece with a board, as shown at W, Fig. 3. This allows the piece to be taken off after the cast is filled in, and the cast to be easily taken out. A sufficient sinking must be made in the body of the frieze panel to allow for the projection of the enrichment. The tympanum is left open to allow for the projection of the enrichment. The grounds of the tympanum and frieze panel enrichments are made about $\frac{3}{4}$ inch larger than the openings, to allow for a bedding ground on the casting mould. A corresponding bed, but double width, is made on the casting mould to receive the enrichments. The bedding grounds of an enrichment and the mould is shown at T and T, on Figs. 2 and 3. The enrichments may also be fixed on the main cast, as described for enriched cornices by the fixed system in Chapter XII. This method of making a reverse piece mould for the pedimental part of the overdoor can be advantageously employed for casting Portland cement pediments *in situ*, as mentioned in Chapter VII.

CHAPTER XIV.

COMPOSITIONS.

PAPIER-MÂCHÉ—MANUFACTURE AND USES FOR DECORATIONS—STAGE PROPERTIES—PAPER CASTS WITHOUT MOULDS—CARTON-PIERRE—ENGLISH AND FRENCH CARTON-PIERRE—FIBROUS SLAB OR PATENT WOOD—PÂTE COULANTE—PASTE COMPOSITION—MAKING SULPHUR MOULDS FOR COMPOSITION—CASTING AND FIXING COMPOSITION—GESSO—GESSO DURO—METHOD OF MAKING AND MANIPULATING—PATENT PLASTER DECORATIONS—DÆKORIA—SMITH'S PATENT METAL.

PAPIER-MÂCHÉ.—Papier-mâché, as its name proclaims, is of French origin. Good examples are still to be found in many French buildings of the sixteenth century. The grand trophies and heraldic devices in the Hall of the Council of Henri II. in the Louvre, as well as the decorations at St Germain and the Hotel des Fermes, on their ceilings and walls, are executed in papier-mâché. In 1730 a church built entirely of papier-mâché was erected at Hoop, near Bergen, in Norway. The inside and outside are covered with this material, which was made waterproof and nearly fireproof by an application of vitriol water, and lime slaked with whey and white of eggs. The decorations of the Pantheon, London, were executed in papier-mâché by Bielefeld. In 1847 E. F. Bielefeld obtained a patent for making moulds for this material; also for making papier-mâché maps in relief. In 1858 White and Parley obtained a patent for improvements in the manufacture of papier-mâché and carton-pierre. The dome of the Palais de Justice of Brussels, which weighs 16 tons, is composed of this material.

PAPIER-MÂCHÉ MANUFACTURE.—Papier-mâché work usually requires two moulds, one for the face of the enrichment, and a counter or core mould to form the cast to the required thickness, which is generally about $\frac{1}{4}$ of an inch. The cast is therefore of less weight, and a saving of material is effected. In some manufactories the paper and ingredients are mixed up in a machine. They are then rolled out into sheets of the required dimensions, placed into the moulds, and subjected to hydraulic or screw pressure. The casts are next placed in a drying-room to accelerate their hardening. When dry, they are carefully trimmed and finished. This substance is used for the decoration of wood cornices; the enrichments for cornices and centre flowers are pressed in parts, and afterwards joined up by mounters. The moulds for stock enrichments are made of brass, copper, type-metal, box-wood, or sulphur. Large pieces, such as panels or flowers, are backed up with wood to strengthen them.

Another mode of making papier-mâché is by gluing or pasting different layers of paper together, and subjecting them to a high pressure until the different strata of paper become as one.

Yet another method, for architectural purposes, is to make a composition of paper pulp and resin. This mass is placed in the moulds, and then layers of strong paper are pressed on the pulp until they adhere and form a homogeneous body.

PAPIER-MÂCHÉ STAGE PROPERTIES.—Modellers and plasterers often find employment in the property rooms of theatres in modelling, moulding, and making masks, heads of animals—the

bodies are made of wicker work, and architectural decorations for solid or built scenes. Papier-mâché properties are produced from plaster piece moulds. Large sheets of brown and blue sugar paper are pasted on both sides, then folded up to allow the paste to thoroughly soak in. The first part of the paper process is known as a "water coat." This is sugar paper soaked in water and torn in small pieces and laid all over the face of the mould, to prevent the actual paper work from adhering. The brown paper is then torn into pieces about 2 inches square, and laid over the water coat, and coats of sugar paper are laid in succession in a similar way until of sufficient thickness to ensure the requisite strength. The various pieces of paper are laid with the joints overlapped. Care must be taken that each coat of paper is well pressed and rubbed into the crevices with the fingers, and a brush, cloth, or sponge, so as to work out the air and obtain perfect cohesion between each layer of paper, and form a correct impress of the mould. After being dried before a fire, the paper cast is taken out of the mould, trimmed up, and painted. A clever man can, by the use of different colours and a little hair, give quite a different appearance to a mask, so that several, taken out of the same mould, will each look quite different. The use of different coloured papers enables any part of the previous coat that may not be covered to be seen and made good. Some property men do not use a water coat, but dry the mould, and then oil or dust the surface with French chalk to prevent the cast sticking to the mould. Others simply paste one side only of the sugar paper that is used for the first coat.

PAPIER-MÂCHÉ MOULDS.—A cast is sometimes required of some part of a building, furniture, or an ornament, which cannot be taken in a plaster mould, or a wax or clay squeeze. In such instances a paper mould, made as follows, may be substituted. Brush several sheets of sugar paper with clean cold water, and lay sheet on sheet to keep it damp. When the paper is pliable, but not wet, lay small pieces on the object to be cast, and press and rub them on with the fingers, modelling tools, and a brush. After the object is all covered, lay brown paper (previously pasted) in the same way, rubbing it well into every part. Give it four or five coats, and when dry, take it off carefully. If possible, make a case by laying plaster over the back before taking the mould off; but if not possible, a plaster case with care may be made after the paper mould is taken off. When dry, give the mould a coat of linseed oil, and let it stand for twenty-four hours, then give it a coat of shellac, and it is ready for casting.

TO MAKE PAPER CASTS WITHOUT MOULDS.—Paper casts, suitable for some purposes, may be made without making a mould, as follows:—Paste some sugar and brown paper on one side, dip the sugar paper in water, and roll it in a damp cloth. Fold up the brown paper and set it aside, ready for use. Then tear the sugar paper into the required sizes, and lay it piece by piece until the object is all covered, using a brush and a modelling tool for pressing it into ornamental parts, taking care that there are no ridges or lumps on the surface. Then lay a coat of the brown paper, keeping it as smooth and uniform in thickness as possible; and finally finish with a coat of sugar paper, leaving the surface smooth and fair. When dry, it is carefully taken off, and strengthened by coating the inside with glue. If the object being imitated is on the round, such as a figure or vase, the cast is cut vertically on both sides with a sharp knife, to free it from the object. If the object is not much undercut, one side only of the cast is cut, and then eased off by degrees. If this is done carefully, the cast will spring back, or it may be bent back to its place. The joints are then glued, and pasted over with paper. It must not be forgotten to oil, or dust the object with French chalk, to prevent the mould or cast sticking. If the pasted papers, when laid aside to absorb, should become fixed or difficult to open, dip them in water, which will free them. Paste is made with flour and cold water well worked together, then boiling water is poured on, and the mass well stirred.

Permanent paste, as used in Italy, is made as follows:—Dissolve 1 oz. of alum in 1 quart of warm water, and when cold add flour until of the consistency of thick paste, then add $\frac{1}{2}$ oz. of resin, 1 oz. of sugar of lead, and as much boiling water as is requisite for the desired thickness.

CARTON-PIERRE.—This substance has a paper base like papier-mâché, and is used for similar purposes. It is an improvement on papier-mâché, and was first introduced by M. Mizière, a Parisian modeller, and further carried out by M. Hire, another Parisian modeller, who reduced the paper to a pulp, mixing it with plaster and dissolved glue. This substance, however, was coarse in texture, and had to be coated with plaster, which again had to be cleaned up by hand. These disadvantages were entirely overcome by M. Romagnesi, who, by reducing the paper pulp to a fine state, adding glue, and mixing whiting as required, was enabled to take very fine lines from delicate originals.

The decorations of the principal apartments of the Tuileries, some in the Louvre, the Palais-Royal, and the Prince of Wales' house at Sandringham, were composed of carton-pierre. It was the leading material for internal decorations in France and Belgium. Statues of all dimensions are made in carton-pierre, and have the advantage of being very light. The annexed illustration (No. 154) shows two candelabras in carton-pierre manufactured by Messrs Jackson & Son, London, who are the principal manufacturers of carton-pierre in England. These beautiful works will show to some extent to what this material can be adopted.

There are various proportions of the several ingredients used, some makers using more glue than others. Some also use plaster to make it set more quickly. The English carton-pierre is much stronger than the French. This is due to the larger percentage of whiting used in the French carton-pierre. Metal moulds are sometimes used for stock patterns. Plaster piece moulds are mostly used for carton-pierre, and the dough-like mixture is hand pressed into the mould in the following manner:—The moulds are seasoned with linseed oil, or shellaced and oiled as required. The soft carton-pierre, or dough, is rolled on a smooth slate or other solid slab, and is mixed with fine whiting, to which a little plaster is sometimes added to give it the required consistency. No more should be stiffened than can be conveniently used, as it may become too stiff to press easily. Cut a small piece off, and roll on the slab to give it a smooth face, and press it into the mould with the point of the forefinger and a small wooden tool. When this piece is firmly and evenly pressed, the ragged joints should be cut clean and square, then wetted with water to make a better joint for the next piece to be laid on. Centre flowers and foliage, &c., are cast without any ground, and in order to strengthen the several parts, thin copper wire is embedded in the weak or thin parts. Very

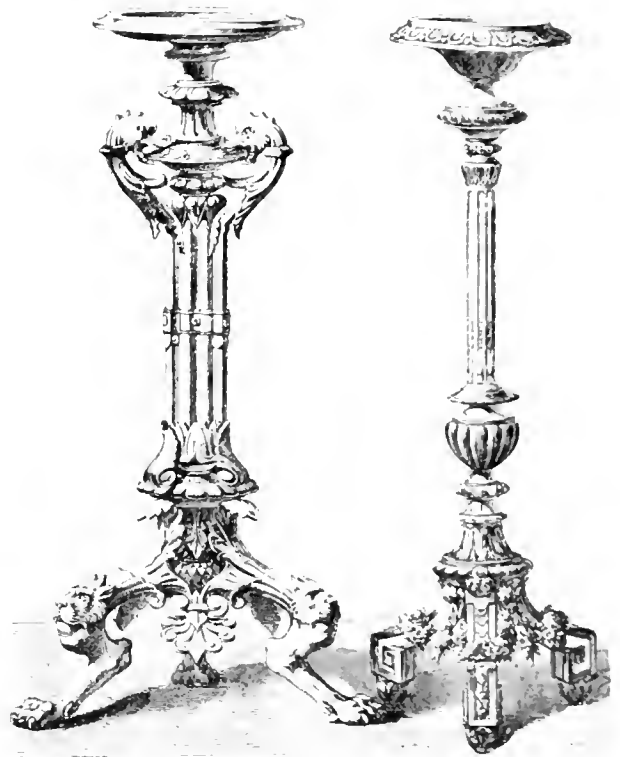

NO. 154.—CANDELABRA IN CARTON-PIERRE.
BY G. JACKSON & SON, LONDON.

thin wire is also carried across from one weak part to another, as in tying one weak tendril to the main stem, to support it until fixed. The wire is then cut off. When the cast in the mould is all pressed and made flush at the edges and rim, it is allowed to stand in a warm place to get firm. Should there be any hollow places in the back of the cast, they are filled up with dry plaster or fine sawdust to keep the cast from sinking. A board large enough to cover the mould is then placed on the top and drawn backwards and forwards, to level the dry filling. The mould is now turned upside down, care being taken to keep the board close to the rim of the mould. The case of the mould is removed, and then the plaster pieces one by one. The cast is kept on the board, and placed in a warm place until properly set. The seams caused by the joints of the mould are now cleaned off by the use of gouge files or small tools, and afterwards sand-papered. The plaster or sawdust on the back, to keep the hollow parts from sinking until set and cleaned up, are cleared out, and as this material becomes very hard, it is necessary to make small holes in the stems and other places before the cast is set, so as to admit of fine brads, screws, or needle points for the purpose of fixing. When fixed on wood, it is usual to glue it on, and drive needle points into the cast to keep it in its place until the glue is set. A thin paste of carton-pierre is also used for fixing it on plaster, further supporting it by the aid of screws or fine brads. Carton-pierre casts can also be made by pressing in jelly moulds. The following proportions are used by the best London and Paris makers. It will be seen that some use alum. This is to prevent the dough from turning mouldy, or having a bad smell. Some use plaster and whiting in equal proportions for stiffening, others only whiting. The better the paper, the stronger the carton-pierre. Old ledgers, or paper made from rags, give the best results. The paper used for wrapping oranges in makes strong work.

Recipe No. 1.—2 lbs. of best glue dissolved in 2 quarts of water, to which is added $\frac{1}{2}$ lb. of flour and $\frac{1}{2}$ lb. of good paper reduced to a fine pulp by boiling and beating. The paper is weighed dry. This mass is all boiled together for one hour, and allowed to simmer for one hour, after which it is poured out on to a slab, and stiffened with sifted whiting. In all cases the whiting should be dried, so as to be more easily ground fine and sifted.

No. 2.—2 lbs. of best town glue dissolved in 3 pints of water, $\frac{1}{2}$ lb. of flour, $\frac{1}{4}$ lb. of ground alum, and 1 lb. of paper. Cut or tear the paper into small pieces, and boil for ten or twelve hours. While hot, add the dissolved glue, also hot, then shake in the flour, alum, and $\frac{1}{4}$ lb. of fine sifted whiting. Stir this mass well, pour out on to a bench, and beat it well, adding sifted whiting until it becomes of the consistency of dough. Fine plaster and whiting is added as required for use. The paper should be taken out, strained, and beaten with a wooden beater, having one end studded with lath nails, so as to reduce the paper to a fine pulp, and boiled again, and strained so as not to retain too much water, which would weaken the glue.

LONDON CARTON-PIERRE.—This recipe is used in many London shops. The following quantities will make a 2-lb. batch:—1 lb. Scotch glue, $\frac{1}{4}$ lb. paper, 5 pints of water, and 14 oz. of flour. The paper used for packing oranges is usually employed for the above. It is simply torn to shreds, and mixed and boiled with the other materials. If a small proportion of chloride of zinc is added to the paper pulp, it will render papier-mâché or carton-pierre nearly as tough as leather.

FRENCH CARTON-PIERRE.—2 $\frac{1}{4}$ lbs. of glue dissolved in 7 pints of water, $\frac{3}{4}$ lb. of paper reduced to a pulp. The glue is added hot to the hot pulp, and the mass boiled together, adding best French whiting. It is then stiffened with plaster when required for pressing.

French carton-pierre was, during the last generation, greatly employed in London for internal decoration. Bénier fils, 96 Rue Blanche, Paris (where the author was engaged for a considerable time in the modelling and carton-pierre studios), had large commissions for the decoration of banks,

offices, and mansions in London and the provinces. The work was made in Paris, and fixed in England by French workmen. The designs were elaborate, but the material and fixing were of a weak and unsatisfactory nature. Jackson & Sons, W. Cubitt & Co., Brown, the Papier-Mâché Company, and other London makers, turn out good, strong, sharp, and clean work, and have turned their French rivals out of the field. Both carton-pierre and papier-mâché have been to a large extent superseded by fibrous plaster, owing to the cheapness and utility of the latter.

FIBROUS SLAB OR PATENT WOOD.—The name given to an invention patented by C. F. Bielefeld, which consists of rolled slabs of carton-pierre. The dome, 140 feet diameter, of the Reading-Room of the British Museum, designed by S. Smirke, R.A., 1856, is constructed internally of this material. The sizes of the panels, composed of three pieces, are 22 feet long by 11 feet 6 inches wide, and were raised in their spherical form to a height of 110 feet, and fixed in one piece to the iron work.

PÂTE COULANTE.—Pâte coulante or liquid paste is a cheap form of carton-pierre, and is principally used for work that requires gelatine moulding, or where the work is used in positions not exposed to much wear. It is much more quickly done than the carton-pierre previously described, because it can be poured into the moulds in a similar manner to plaster, thus avoiding the slow process of hand pressing. Pâte coulante casts are generally made in jelly moulds.

Pâte coulante is made in two different ways. The common way is to mix equal proportions of plaster and ground whiting with as much dissolved glue as will make the whole run freely, adding ground alum as required. The addition of alum not only hardens the plaster, but also hastens the setting, thus allowing the cast to be taken out of the mould more quickly. The other method of making pâte coulante is by adding a proportion of fine paper pulp to the plaster whiting and glue. Tissue paper is the best for this purpose.

COMPOSITION.—This substance, it is said, was invented by one Liadort, a Swiss clergyman. It has been used in France from the time of Louis XIV. in the decorations of buildings, and picture and mirror frames. It was introduced into England about 1767 by Robert Adam. He employed it for the decorations of ceilings, walls, chimney-pieces, doors, and window-shutters in many mansions throughout the three kingdoms. There are numerous examples of this work, designed by Adam, now to be seen, which for sharpness and cleanliness cannot be distinguished from wood. In point of fact, it has withstood the test of one hundred and thirty years better than the stone and wood on which it is fixed, this ornament being as perfect to-day as when it was first fixed. This material was first made in London by Italian workmen, who jealously guarded the secret of its preparation; but it was eventually discovered by John Jackson, the grandfather of the present firm of G. Jackson & Sons, who was employed on some houses in Portland Place, designed by Adam, where the Italians were decorating the interiors with composition enrichments.

It was then made and shown by Mr Jackson in a shop in Goodge Street, in the form of balls strung on threads, and as small ornaments, &c. After Mr Jackson's discovery it was largely used in the decorations of houses, chimney-pieces, mirror and picture frames, furniture, musical instruments, chandeliers, public bars, and similar works, as a substitute for wood-carving. It was largely used in Edinburgh, Glasgow, Dublin, and other towns for the decoration of wood mouldings on shop fronts, many of which are still in existence, and the composition seems harder and in a better state of preservation than the wood work on which it was fixed. This gives ample evidence of its durability, even when exposed to all weathers. Granite, stone, and Portland cement having to a great extent superseded wood façades, composition, or "paste-compo," as it is technically termed, is

not so much used as formerly for exterior work. It is still in general use for decorating mirror and picture frames, also ship saloons and capitals of iron columns, and interior wood work.

Owing to the flexible nature of paste-compo when moist, it is often used for forming mouldings and decorations on circular work. When set, it is not so liable to be chipped as most woods. It can be painted and gilded as required. There are various ways and quantities of materials used for making paste-compo, each maker having a special recipe, but they all come nearly to the same thing. The late G. Baldwin, foreman plasterer to W. Cubitt & Co., London, made this and carton-pierre a study, and improved both materials considerably. He introduced the use of Burgundy pitch, which deprives paste-compo of its shrinking faults, also Venice turpentine, which has the same effect, and renders it tougher. When made, the compo batches are kept warm for use by means of a pan or "steamer," having a close-fitting lid, and the bottom perforated to admit hot steam. The batches are kept warm and pliable by covering with a piece of old blanket, or house flannel, to retain the steam. For a small job, or where paste-compo is not often required, the handy shop-hand can soon turn an old oil-can or pail into a steamer. This is best done by fixing a perforated bottom about half-way down the pail, which has its bottom either knocked out or well perforated, or by placing a small pail inside a larger one, the bottom of the small pail being well perforated to admit the steam. An old pail without a bottom, so as to form a stand, will do for the large or outside receptacle. The pail is placed in boiling water, care being taken that the water does not reach the dough.

The moulds are generally made in sulphur, but some large manufacturers keep metal and box-wood and pear-wood moulds for stock designs. Metal moulds are usually made of brass, copper, iron, or pewter. Smith's Metal is an excellent material for this purpose. Box-wood or pear-wood moulds require to be carved, which only a skilled carver can do, as they have to be cut or sunk the reverse way to the given design.

SULPHUR MOULDS.—Sulphur moulds are made by dissolving the sulphur (which is generally sold in sticks) over a slow fire in an iron pot, continually stirring to prevent burning. When melted, it is allowed to stand until sufficiently cool to pour on the original. The originals are soaked in water, and treated in the same way as for wax moulding. A good guide to know when it is fit for pouring on is to let it stand until a thin skin has formed on the top, then break the skin at the side of the pot intended for pouring out. The mould should be taken off as soon as possible, for being so hot, it might otherwise burn the face of the original. It also comes off easier before contraction has taken place by the cooling of the sulphur. To make the mould stronger, so as to resist the force of screw pressure, steel or iron filings are put in the back of the mould before it gets cool. Old moulds, when broken up for remelting, have these steel or iron filings in them, which fall to the bottom of the pot during the process of melting. They require to be continually stirred to keep them from forming into a solid lump, or getting too hot and setting fire to the sulphur, as sometimes happens. Should the sulphur catch fire, remove the pot from the fire, and cover it with an old plaster or cement bag to extinguish the flames. It only requires attention to prevent this mishap. Burnt sulphur does not run so freely, and does not take so fine an impression, as when pure.

When all the sulphur is melted, it is taken off and stirred for a few minutes, and then allowed to cool until a skin is formed, as previously described. When the mould is full, a quantity of the filings are taken out of the pot by means of an iron ladle (the stirring ladle), and placed in the back of the mould. When the mould is taken off, it is bedded with Parian cement or plaster into a wooden block, which has a sinking about $\frac{1}{2}$ inch larger in length, breadth, and depth than the size

of the mould, the space between the mould and the wood being for the cement, to ensure a close and firm foundation for the mould. The mould is fixed about $\frac{1}{8}$ of an inch below the level of the block, so as to protect the mould from the screw pressure. The block should have a margin of about 3 inches all round the mould. When the mould is deep, the block is bound or clamped with iron to strengthen it. Cast-iron cases are also used for stock designs.

Sulphur, commonly called brimstone, is a yellow brittle solid. It is not soluble in water, but is soluble in carbon disulphate, oil of turpentine, and benzole. When heated at its lowest possible temperature, about 100 degrees, it forms a limpid liquid of a light yellow colour; but if this liquid be heated to about 150 degrees, it begins to become viscid and dark coloured, it is thick and so tenacious that it cannot be poured out of the pot. If heated still more, it regains its fluidity in part, is still dark coloured, and finally, when it begins to boil, is converted into an amber-coloured liquid. Sulphur is also used for moulding delicate work, such as medallions, plaques, and metal panels.

CASTING COMPOSITION.—When the mould and the paste-compo are ready, the mould is oiled with linseed oil, thinned with paraffin oil (sweet oil is a bad ground for paint), and a piece of the compo large enough for the intended purpose is then taken up in a warm state, and rolled about the length and width of the mould. The smoother the face of this roll, the better the cast, and the less chance of seams or wrinkles. The roll is pressed into the mould by hand. The compo should be about $\frac{1}{4}$ inch above the level of the block to allow for pressure. A wet board, about the size of the block, is placed upon the surface of the compo, and the whole is then put under a powerful swing screw-press, by which the compo is pressed into every part of the mould. The same pressure causes the wet board to adhere to the upper surface of the compo, so that when the mould is taken from under the press, the board may be pulled straight up with the cast adhering to it. There will be a ground of compo about $\frac{1}{4}$ inch thick, according to the amount of pressure. The cast is cut (with a broad double-handed knife) from the ground, which is a good guide for cutting the cast straight. The ground is then cut or peeled off the board, and put into the steamer for the purpose of being warmed up again. The mould and the board are now ready for another cast. It is usual to have three or four boards for one mould, so that a cast can stand to harden a little, when it is cut more easily. The casts are allowed to stand until hard, and to allow for shrinkage before being fixed. The casts are exceedingly pliant and supple, and may be bent into any form without breaking. They can be applied to the round, the flat, or the hollow with equal ease. When the casts are kept too long, and become hard, they may be made soft and pliable by steaming, or by laying the back of the casts on hot steamed flannel. The casts are fixed on with glue and needle points; and if the casts are soft, the backs are dipped in or brushed with hot water, which, by softening the glue contained in the compo, forms a cementing paste that adheres to wood, but the former way is the best. The casts require to be jointed like plaster casts, care being taken to keep the joints as square as possible, so that there may be no hollow parts at the joints. The joints are stopped with a piece of soft compo. If the joints are cut true and square, and the casts well pressed up against each other, little or no stopping will be required.

The following quantities are used by different makers of repute:—

No. 1.—3 lbs. of best town glue dissolved in as much water as will just cover it, $1\frac{1}{2}$ lbs. of resin, 3 gills of linseed oil, $\frac{1}{4}$ lb. of Burgundy pitch. The glue is allowed to swell in the water for four or five hours, and then dissolved by means of heat in a water-bath. The oil, resin, and pitch are melted in a separate pot (taking care that it does not boil over), and when cooled, is poured into the pot containing the melted glue, all being well stirred together. It is afterwards poured on a slab, or clean smooth bench, on which is formed a ring of well-dried and sifted whiting. It is then well

mixed up, kneaded, rolled, and beaten, until it becomes a smooth, tough, elastic kind of dough or oil putty. No more whiting is used than will make a stiff dough, and divide the batch into cakes, and put them aside until required. They are softened by steaming when required for pressing.

No. 2.—Best glue, 2½ lbs.; resin, 2 lbs.; linseed oil, 1 pint. The ingredients are melted, mixed, and rolled until they assume the consistency of a dough, as described in No. 1.

No. 3.—Good Scotch glue, 3 lbs.; resin, ½ lb.; linseed oil, ½ pint; boiled oil, ¼ pint; Burgundy pitch, ¼ lb.; Venice turpentine, ¼ lb. The ingredients are mixed in the same way as in the other recipes, the Burgundy pitch and Venice turpentine being melted with the resin and oil.

It will be seen that the proportions are all nearly alike, being nearly 1 lb. of resin and 1 gill of linseed oil to 1 lb. of glue. When Burgundy pitch is used, the quantity of resin is less, and the quantity of oil is regulated according to the strength of the glue. The best glue only should be used. The whiting should be well dried and ground fine, or it will lie in small dry patches in the work, and spoil it. Gilders' London white is best. When a screw-press, with swing ball, is not at hand, an ordinary copying-press may be utilised for small work. Some plasterers use a compo composed mostly of glue and whiting, and a small quantity of resin, for gallery fronts, or other places not exposed to wear and tear. This is hand pressed, but it has not nearly the same amount of strength as the machine-pressed work.

LONDON COMPOSITION.—The following quantities will make a 16 lb. batch. This is an old recipe, and is mostly used in London shops. Dissolve 16 lbs. of town glue and 5 pints of water in one pot, and dissolve 9 lbs. of ground resin and 3½ pints of linseed oil in another pot. When both are dissolved, pour the glue into the resin-pot, and stir well with a stout stick. Sprinkle in sifted whiting until of the consistency of thin dough, and then turn the mass out on a slab, and knead it well, adding whiting as required.

Composition for picture or glass frames is made as follows:—Dissolve 7 lbs. of best Scotch glue in 2½ pints of water, then add 5 gills of linseed oil, 3½ lbs. of resin, and ¼ lb. of pitch. Boil the whole together, keep stirring until dissolved, then add as much sifted whiting as will make it into a stiff yet pliable dough. It is then ready for pressing into the mould.

The addition to either of the above recipes of 3 oz. of coarse sugar dissolved in water to each pound of glue will keep the material more pliable, and assists in combining better with the linseed oil. The glue for fixing is further improved by adding 1½ oz. of sugar and 1 oz. of linseed oil to each pound of glue.

GESSO.—Gesso is a very ancient process, and like most ancient processes, is very simple. Its remote ancestor was probably the craft of painting in "slip" clays on vases or other fictile productions, and in this form it still survives on the commonest earthenware, and in those most refined and beautiful works in *pâte-sur-pâte*, whereon M. Solon records the art history of our time—works which will be valued in the future as we now value a Greek cameo. From the use of clay to that of chalk the transition is easy, and calcined chalk in the form of whiting was soon found to be the best couch to receive the painted or gilded decoration of the wooden statues and pictured panels of the earliest times, as witness the Egyptian mummy cases and other work which the dryness of the African climate has preserved to us.

To render this whiting or "gesso" stable, it was necessary to mix some viscid liquid with it, such as glue or size. This was soon found to be a convenient vehicle for obtaining low relief, and thus modelling in gesso took its place amongst the decorative arts, and especially as an accessory to the painter. The work of the early Byzantine painters illustrates this.

A visit to the National Gallery will demonstrate the use made of "gesso" by the early artists,

and the retable in Westminster Abbey affords a valuable illustration of its use as an architectural accessory. At the Renaissance of decorative art it covered the cassoni, the larger articles of furniture, and the panels of the wainscotting. Gesso became the general basis for the more delicate work of that refined period, lingering on till the latter half of the last century. Sir E. Burne Jones, Mr G. T. Robinson, and Mr Walter Crane have given an impetus to the art of "gesso," which bids fair to carry it onwards, until its modern history may rival its past. Mr Robinson says he first used plaster instead of whiting, making use of glue and a little oil to render it fluent. This produced a remarkably hard body, capable of being either laid on with a brush or modelled up with steel modelling tools. When gilt, it looked like wrought metal work. It adheres so closely to glass, marble, porcelain, or polished wood, that purposed fracture of the base on which it is laid will go through the gesso without chipping it from the surface. Whiting is easier to work than plaster. The beginner should use the best gilders' whiting, which is much purer than the ordinary whiting of commerce. The glue should be of the best make, macerated in cold water until it will not swell, and the linseed oil should be of the oldest and cleanest kind. The quantities for each vary according to the nature of the work proposed to be done. It is difficult to give any definite proportions, but a few experiments will readily enable the worker to ascertain the mixture best suited to his purpose.

Mr Walter Crane's recipe for the preparation of "gesso" is as follows:—Boil 1 part of powdered resin in 4 parts of linseed oil and 6 parts melted glue, and mix well together. Soak whiting in water, and add to the above mixture to make it the consistency of thick cream. Mr Robinson does not use resin, and thinks it is not at all necessary. It may retard absorption of moisture of the material by the ground, but is apt to cause the work to flake off from it. Absorption may be prevented by other means, and the gesso itself is less liable to crack when the resin is omitted.

The mode of applying the material depends upon what is wanted to be done, and what it is to be done upon. It can be used upon any material, and if it is wood, give the surface a thin coat of French polish if the wood is required to remain visible. If the surface is required to be covered all over with "gesso," glue thin canvas or "skrim" over it to give it a key, and rub this over with thin glue. If on fibrous plaster, after tracing the outline, scratch well the ground to make the gesso adhere, and stop absorption by a thin coat of shellac, or give two coats of thin glue. The work is now ready to commence. If it is in high relief, roughly boss out the higher portions with fine tow or cotton wool steeped in the "gesso." Wait until it is partially set, and then with a brush paint over it, coat by coat, with fluent "gesso," until the general form is attained, using thin glue and water whenever the absorption becomes rapid. The finishing coats and finer work should have a little more oil added to them, so that the mixture may dry with a smooth and even surface, or it may be finished with a modelling tool. To do this, it is well to let the work dry first, and soften the surface by the application of glue water. The vessel containing the mixture should be kept standing on a stove in another full of hot water, that the "gesso" may be kept at about the same consistency, as if it chills it becomes "ropy," and has a tendency to flake in drying. If modelling comes easier than brush work, the work may be commenced with a mixture thickened with stiffened glue and more whiting, modelling with it as with clay or wax, care being taken not to put it on too thickly at a time, and also to oil the finger and tools. When a high finish is required, it may be worked up with graver or small tools, polishing the surface, if required, with fine pumice-stone or Dutch rush. Beautiful and rich effects can be produced on backgrounds by a repeated ornament, arranged diaper-wise, and impressed by a stamp. The stamps may be moulded from

original designs or from any intaglio ornament in a mixture of plaster of Paris and flour paste, which also, when rolled out thin, forms an admirable ground for "gesso" ornamentation. This is the "pastiglia" of the Italians, and its adaptability may be learned by examining the model of the Villa Madama in the South Kensington Museum.

The whiting may be stained almost any colour, and by using relief of one colour and the groundwork of another, it will produce cameo-like effects. It can be gilded, lacquered, or painted to any degree, but in the latter two cases more labour and less oil must be used in the finishing coats.

Gesso has been described as relief painting. The gesso is mixed to about the consistency of cream, and applied with a brush, as already stated. The brushes are composed of hog's hair and camel's hair—fitches and pencils—using steel modelling tools for high relief. The design is traced on the surface and the gesso laid on while yet plastic. As it dries rapidly, the worker must be prompt to begin and finish the part in hand.

CEILING IN GESSO.—Plate XLIV. depicts a most charming and highly artistic ceiling, in the Saloon at Coombe Park, Sevenoaks, designed and executed by Mr Walter Crane, assisted by the late Osmund Weeks, in 1880. The following description of this ceiling is by Mr Crane :—

"The main mouldings which separate the panels (left blank in the plate) represent the position of existing mouldings, and my work was to fill the blank panels thus spaced. The theme of the design is a combination of the planets, and the seasons and times of day. The centre circle represents the revolving wheel of the seasons, with the sun in the centre, and the signs of the Zodiac on the rim. Two winged figures support the circle at each end of the panel, and two fans repeat the radiating and circular forms. In the long panels, right and left, are (right hand) Mercury in the circle, Morning in the square below, Noon above, while Evening and Night fill the corresponding panels on the other side, with Luna for the centre. These subjects are connected and enclosed by a framework of figures typical of the hours, with globes and sickles and hour-glasses. At each end of the central panel is a squarish panel filled by a figure of Jupiter and Saturn respectively, enclosed in circles, with smaller figures at the corners representing their satellites, crescent forms being afterwards adopted for these. The four panels at the corners of the ceiling represent the planets Mars, Venus, Urania, and Neptune. These figures are about 5 feet high.

"The figure panels were all worked in gesso or rather stucco, consisting of plaster of Paris, size, and cotton wool upon fibrous plaster panels with a roughish ground, supplied by Messrs Jackson & Sons, of Rathbone Place, who also executed the casts of the repeating portions from my models, and also the repeating mouldings of the framework; but casting was only used for the repeating portions of the work. All the rest, both of the figure and ornamental work, was done in the stucco direct on the panels, which were worked in the studio, and afterwards put up.

"The ceiling was coloured in tones of white and yellow metal and bronze, repeated in different proportions in the general scheme of coloration in the room."

PLASTER AND GESSO CEILING.—As already stated, gesso is often used in combination with fibrous plaster and in lime plaster for ceiling decoration. An example of a plaster ceiling with gesso panels, from a design by M. Lenard, is displayed on illustration No. 155. The three panels with figures are designed for gesso work.

GESSO DURO.—*Gesso duro* simply means hardened or durable plaster. Gesso is a name very frequently misused for stucco. There are various sorts of gesso. *Gesso duro* is gauged with plaster, and *gesso sottile* with whiting instead of plaster. *Gesso grosso* is specially prepared plaster.

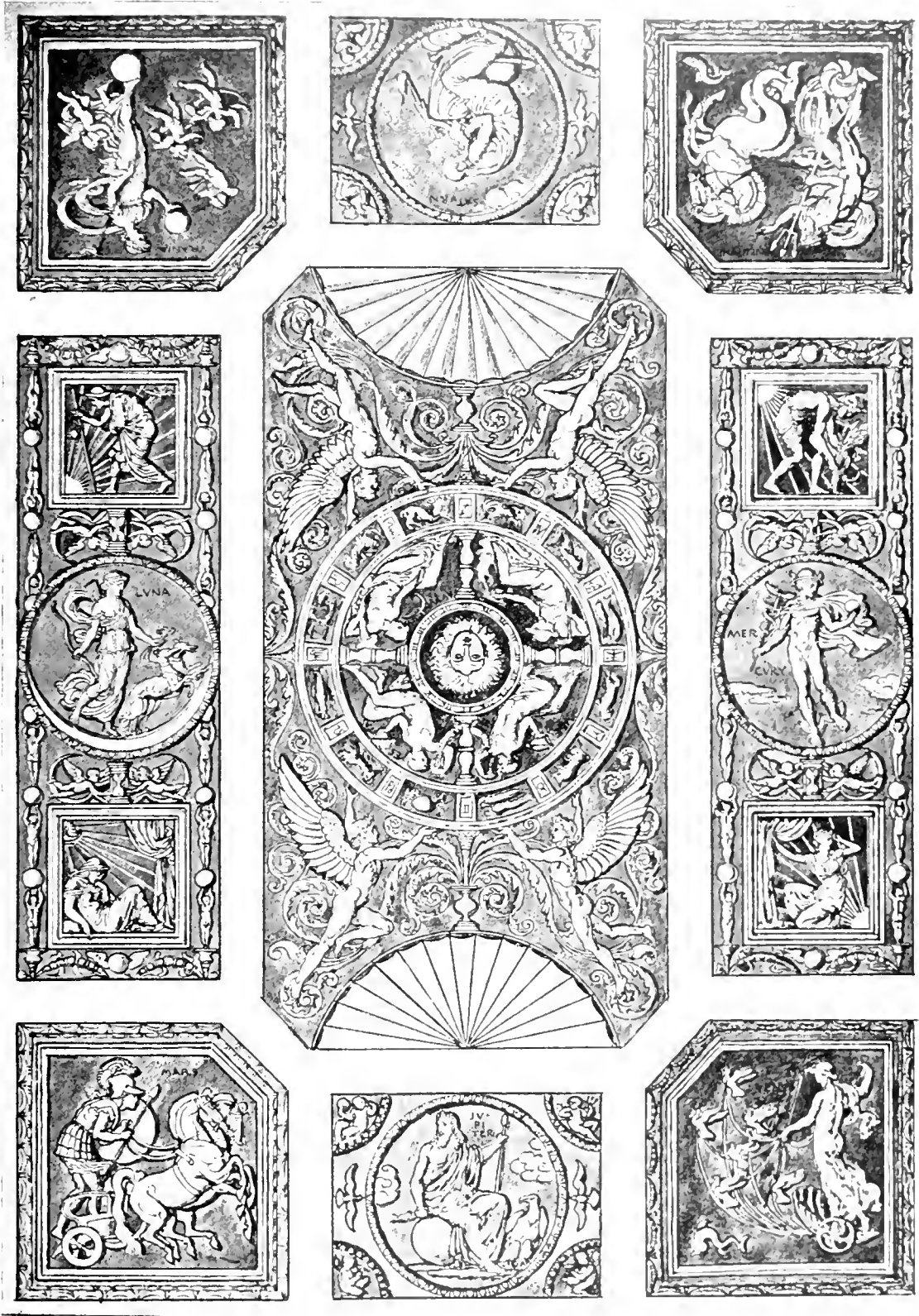

CEILING IN GESSO, IN THE SALOON AT COMBE PARK, SALISBURY, DESIGNED AND MODELLED BY WALTER CRANF, 1880.



The following extracts from the MS. of Cennino Cennini a pupil of Agnolo, himself a pupil of Giotto, written in 1437, and translated by Mrs Merrifield in 1844, will be interesting and invaluable, as throwing light on the methods of gesso and tempera painting, dissolving glue, the use of plaster, glue, and linen, and giving recipes for *gesso grosso* and *gesso sottile*:—

How to Begin to Paint Pictures.—In the first place, a panel of the wood of the poplar, lime, or willow tree must be prepared, on which to paint the picture. Let it be made quite smooth.

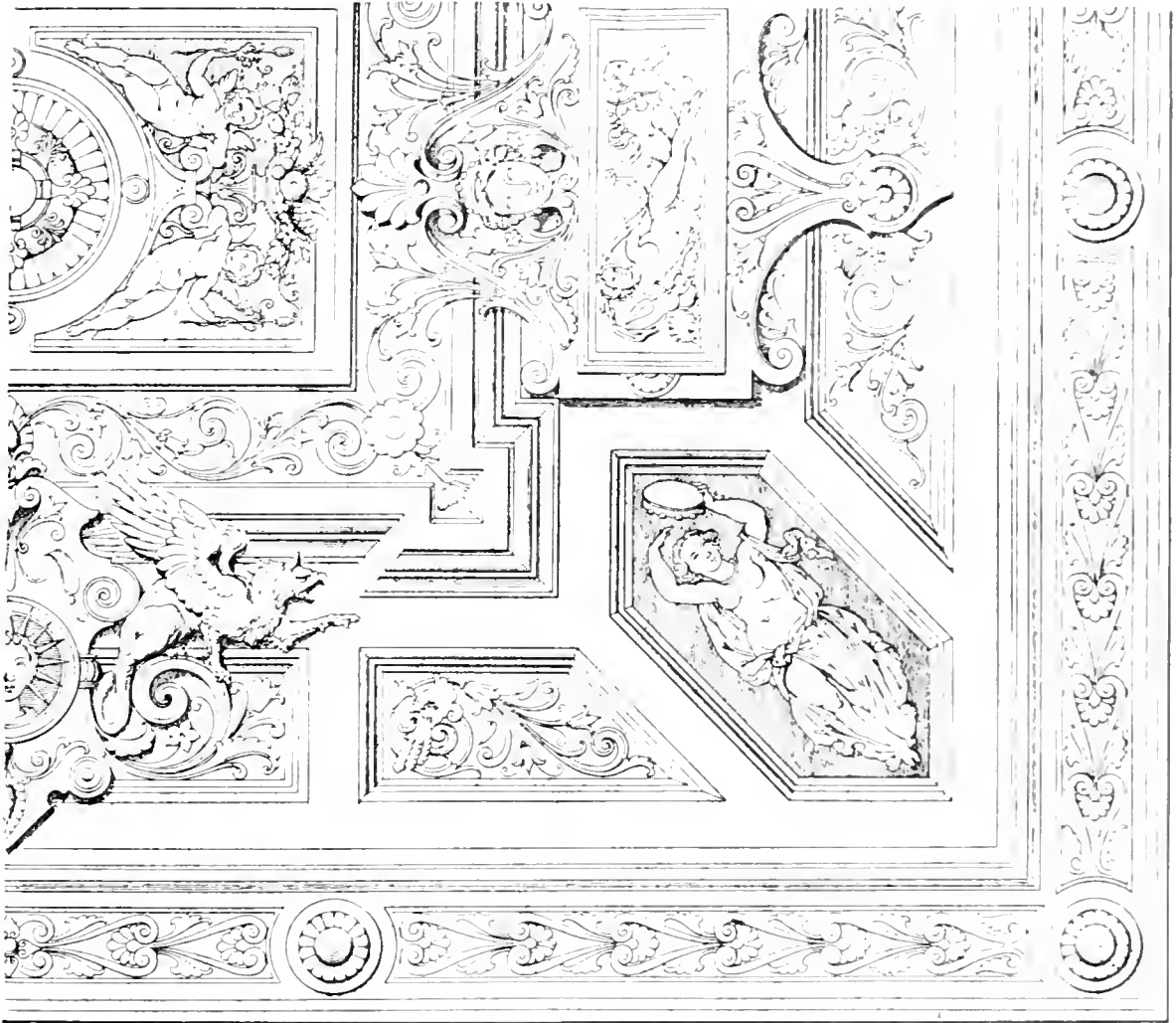

NO. 135.—PORTION OF A PLASTER CEILING, WITH FIGURE PANELS IN GESSO, MODERN.

If it be defaced with knots, or if it be greasy, you must cut it away as far as the grease extends, for there is no other remedy. The wood must be very dry; and if it be such a piece that you can boil in a cauldron of clean water, after the boiling it will never split. Let us now return to the knots, or any other defect in the smoothness of the panel. Take some glue *colla di spicchi*, and about a glassful of clean water; melt and boil two pieces *spicchi* in a pipkin free from grease; then put in a porringer some sawdust and knead it into the glue; fill up the defects

or knots with a wooden spatula, and let them remain; then scrape them with the point of a knife till they are level with the rest of the panel. Examine if there be any nail or other thing that renders the panel uneven, and knock it into the panel; then provide some pieces of tinplate, like *quattrini* (small pieces of money), and cover over the iron with them; and this is done that the rust of the iron may not rise through the ground. The surface of the panel cannot be too smooth. Boil some glue, made of parchment shavings, till the water be reduced to one-third of what it was at first, and when put on the hands, if one hand stick to the other, it is sufficiently boiled. Strain it two or three times, put half this glue into a pipkin, add a third part water, and boil well together; then, with a hog's-hair pencil, large and soft, pass a coat of the glue over the panel, or foliage, or pyxes *cibori*, or columns, or whatever you work upon, that is to be covered with a ground *ingessare*, and let it dry; then take some of your first strong glue (*colla forte*), and pass twice over your work, letting it dry well between each coat of glue, and it will be glued to perfection. Do you know the effect of the first glue? A weak water or liquor is absorbed from it by the wood, which operates exactly as if, when fasting, you eat a few comfits and drink a glass of wine, which gives you an appetite for dinner; so this glue prepares the wood for the glue and grounds to be applied afterwards.

How to Fasten Linen on Panels.—Having thus spread the glue, get some linen cloth, old, fine and white, and free from grease. Take your best glue, cut or tear this linen into large or small strips, soak these in the glue and spread it with your hands over the surface of the panel, remove the seams and spread it well with the palms of the hands, and leave it to dry for two days. And remember it is best to use glue when the weather is dry and windy. Glue is stronger in the winter. For gilding, the weather should be damp and rainy.

How to Lay Grounds of Gesso Grosso on the Surface of a Picture with a Spatula.—Where the panel is very dry, take the point of a knife like a rasp (*mello*), rasp it well, and make the surface quite even. Then take some gesso grosso, that is to say, volterrano, purified and sifted like flour. Put a porringerful on the porphyry slab, grind it well with this glue, as you would grind colours, collect it, and put it on the surface of the pictures, and with a very smooth and rather large spatula cover the whole surface, and wherever you can use the spatula do so. Then take some of this ground plaster *gesso*, warm it, take a soft hog's-hair pencil, and give a coat on the cornices and foliage and on the even surfaces with the spatula. Give three or four coats on the other parts of the cornices, but on the other level parts you cannot use too much. Leave it to dry for two or three days. Then take the iron rasp (*mesella*), and level the surface; procure some small iron rods, which are called *riffiette*, such as you will find in the painters', who use several kinds of them. Pick out all the cornices and foliage which are not flat, and with these make every part of the surface of the ground smooth and free from knots.

How to Prepare a Fine Ground (Gesso Sottile) for Pictures.—You must now prepare a plaster for fine grounds, called gesso sottile. This is made from the same plaster as the last, but it must be well washed (*purgata*), and kept moist in a large tub for at least a month; stir it up well every day until it almost rots (*marcise*), and is completely slaked, and it will become as soft as silk. Throw away the water, make it into cakes and let it dry, and this plaster (*gesso*) is sold by the apothecaries to our painters. It is used for grounds for gilding, for working in relief, and other fine works.

How to Prepare a Ground of Gesso Sottile on a Picture, and how it is to be Tempered.—Having laid on the gesso grosso, rubbed down the surface, and polished it well and delicately, put some cakes of the gesso sottile into a pipkin of water, and let them absorb as much as they will. Put a small portion of it at a time on the porphyry slab, and without adding any water to it, grind it to an

impalpable powder. Put it then on a piece of linen cloth, strong and white. When you have ground as much of it as you want (for you must consider what quantity you will want that you may neither have to make two portions of tempered plaster nor to throw away any good plaster,) take some of the same glue with which you tempered the gesso grosso. You must make sufficient at one time to temper both kinds of gesso. The gesso sottile requires less tempering than the gesso grosso; the reason for this is that the gesso grosso is the foundation of all your work, and that how much soever you press the gesso grosso, a little water will still remain in it. For this reason, make the same kind of glue for both. Take a new pipkin which is free from grease, and if it be glazed, so much the better. Take a cake of this gesso sottile, and scrape it fine with a knife, as you would cheese, and put it into the pipkin. Put some of the glue on it, and stir the gesso as you would a paste for making fritters, smoothly and evenly, until there are no longer any lumps. Procure a cauldron of water and make it very hot, and put into it the pipkin containing the tempered gesso. Thus the gesso will become warm, but will not boil, for if it should boil it would be spoiled. When it is warm, take your picture, and a large and very soft pencil of hog's bristles, dipped in the pipkin, and taking up a proper quantity at a time, neither too much nor too little, spread it evenly over the level surfaces, the cornices, and the foliage. It is true that in doing this the first time you should spread and rub the gesso with your fingers and hand wherever you can, and this will incorporate the gesso grosso with the gesso sottile. When you have done this, begin again and spread it with the brush, without touching it with the hand. Let it rest a little, but not so long as to dry thoroughly; then pass over it a third time with the brush, and let it dry as usual. Then give it a coat on the other side, and in this manner, always keeping the gesso warm, give the panels eight coats. Foliage and relievos require less, but you cannot put too much on cloths. This is on account of the rasping or rubbing down, which is done afterwards.

"How to Begin to Smooth the Surface of a Panel on which you have Laid a Ground of Gesso Sottile.—When you have finished laying the ground (which must be done in one day, even if you work at it in the night, in order to complete it in the usual way, let it dry in the shade for two days and nights at least. The drier it is the better. Tie some powdered charcoal in a piece of linen, and sift it over the ground of the picture. Then, with the feather of a hen or goose, spread this black powder equally over the ground, because the panel cannot be made too smooth, and because the iron with which you rub the picture is smooth also. When you remove it, the ground will be as white as milk, and you will then see whether it requires more rubbing with the iron.

"How to Plane Surfaces on which Gesso Sottile has been Laid, and of what use the Planing is.—Take a flat raffietto, about as wide as a finger, and gently rub the surface of the cornice once; then, with a sharp rasp (*mella arrotata*), which you must hold as freely and lightly as you possibly can, rub over the surface of the panel with a very light hand, brushing away the loose gesso with the feather. And know that this dust is excellent for removing grease from the pages of books (*carte de libri*). In the same manner rub smooth the cornices and foliage, and polish them as if they were ivory. And sometimes, for you may have many kinds of work, you may polish cornices and foliage by rubbing them with a piece of linen, first wetted and then squeezed almost dry."

The bands of old linen evidently serve the purpose of the sand in the Egyptian method. They afford a tooth for the plaster, and at the same time must help to hold the panel together, and also help to prevent soap or resin rising through the gesso surface. Apparently, linen was also used for the best coffins in Egypt in the same way. The gesso volterrano is, according to Mrs Merrifield, plaster of Paris, which was obtained from some gypsum quarries in the neighbourhood of Bologna, and Vasari gives a long account of this gesso volterrano in his life of Andrea Verrocchio,

who used it to make casts of dead persons. It will be noted that the gypsum for the final coating of gesso is thoroughly slaked by keeping in water for some weeks.

A very fine example of gesso work exists in the old cathedral church at Coire. They have there a box which they claim to be as old as the ninth century. It is entirely covered with gesso, on which a design in low relief has been roughly scrolled. The gesso has been polished, so as to give the appearance of ivory. At the corners, where it has got chipped off, the ends of the linen can be seen, which has evidently been put next the wood, as Cennino Cennini advises.

PATENT PLASTER DECORATIONS.—A new patent plaster has recently been introduced by the Mural Decorations Company. This material has plaster as a basis, to which is added wood-wool and fibre fabric, the whole being treated in a peculiar method, so as to produce a hard, tough, yet light substance. It is claimed that the patent was granted, because it is the only plaster decoration with that relief, which is the *ultima thule* of the piece moulder's art. It can be easily fixed by screws or nails to any surface. The designs of the stock decorations are unique and highly artistic.

DIKORIA—Under this designation a novel specialty has been introduced by Messrs H. & A. Hooydonk. Plaster forms the basis of *dakoria*, which is specially prepared so as to produce a hard and tough material. It will reproduce the highest relief, with all the fine details and undercut of carved work and chased metal.

SMITH'S PATENT METAL.—This metal is an improvement on Spence's composition metal, and is used in the construction of casts as well as moulds. Reproductions in this metal give the most delicate lines and forms in figures and foliage. Being of a very durable nature, and not affected by acids, lime, or damp, it has special advantages for making moulds for casting fine concrete, Portland cement, and white cements. It is a useful substitute for sulphur for casting composition enrichments; also for wax for casting fibrous plaster enrichments. It may also be employed in the construction of the moulds of enrichments in reverse moulds for casting fibrous plaster cornices. Casts in this metal, taken out of moulds having a polished surface, have a glossy or polished surface equal to the polish on the moulds. Beautiful casts, highly undercut, can be produced in it from gelatine moulds. This metal is dissolved and used in a similar way as sulphur, but iron filings are not required. Piece moulds in this metal are made as described for piece moulding in wax.

CHAPTER XV.

SCAGLIOLA.

HISTORICAL—ARTIFICIAL MARBLES—SCAGLIOLA—MANUFACTURE—MIXING—COLOURS AND QUANTITIES—POLISHING AND FIXING—EGYPTIAN GREEN—BROWN BELGE—ROUGE ROYAL—GREEN GENOVA—VERT—VERT—GRIOU—SPANISH BUFF—VERD ANTIQUE—BLACK AND GOLD—VERIA ALPS—ROME DE LA VANTZ—DEVONSHIRE RED—MAREZZO—MAKING AND POLISHING—GRANITE FINISH—GRANITE PLASTERING.

HISTORICAL.—Scagliola derives its name from the use of a great number of small pieces or splinters; *scagliole* of marble being used in the best description of this work. It is said to have been invented in the early part of the sixteenth century by Guido Sassi, of Cari, in Lombardy, but it is more probable that he revived an old process, and introduced a greater variety of colours in the small pieces of marble and alabaster used to harden the surface, and better imitate real and rare marbles. It is sometimes called *mischia*, from the many mixtures of colours introduced by it. The use of coloured plaster for imitating marbles was known to the ancients, although the pure white, or *marmoratum opus* and *albarum opus*, mentioned by Pliny, was more used. The plastic materials used by the Egyptians in coating the walls of their tombs partook of the nature of marble. The ancients also used a marble-like plaster for lining the bottoms and sides of their aqueducts, which has endured for many centuries without spoiling or cracking. In the decoration of their domes the Moors used coloured plasters, which have stood the ravages of time. The beautiful *chunam*, or plaster of India, as used by the natives, has a hard surface, takes a brilliant polish rivalling that of real marble, and has withstood for many ages the sun and weather without sign of decay. The roofs and floors of many houses in Venice are coated with smooth and polished plaster, made at a later date, strong enough to resist the effects of wear and weather, without visible signs of crack or flaw, and without much injury from the foot. Scagliola was largely employed by the Florentines in some of their most elaborate works. It has been used in France with great success for architectural embellishments, and was first introduced into this country by Mr J. Wyatt about the middle of the last century, and was used for the columns in the Pantheon in Oxford Street. Mr Wilson, in the *Edinburgh New Phil. Journal*, 1841, writes: "Plastering is now carried to great perfection in Italy. The rooms are so finished that no additional work in the shape of house-painting is required, the polish of the plaster and its evenness of tint rivalling porcelain. Scagliola is the material chiefly used. At times the surface of the plaster is fluted, or various designs are executed in intaglio upon it in the most beautiful manner."

The walls of the grand staircase at Buckingham Palace were covered with scagliola. The work was done *in situ* upon lathwork, but through the carelessness of some other class of workmen, working overhead, who spilt some saline matter, the walls were spoilt, and had to be painted. There is a range of columns in the Throne Room, some of which are a bright scarlet, and others a rich blue, in imitation of *lapis lazuli*. The fluted three-quarter columns supporting the roof and gallery in the Reform Club are of scagliola, worked *in situ* upon stone cores. The fluted three-

quarter columns in the drawing and coffee rooms were cast in 3 feet lengths, each backed with tiles bedded in coarse plaster. The scagliola on the walls of the staircase is worked on brickwork, panelled, moulded, and inlaid. A church at Wilton Wells has some fine scagliola columns, some of which are black and gold, composed of Keen's cement, and worked upon stone cores, and two twisted columns in the chancel are formed with plaster. A beautiful specimen of this work was done eighty years ago at Whitehall, London, and is an exquisite imitation of jasper. Twenty-seven tints may be counted in a square foot on the surface. There are some magnificent examples at the Duke of Hamilton's Palace, near Glasgow. The walls of the hall and staircase of a house at Hillhead, Glasgow, were covered with scagliola slabs equal in size to the required courses. These slabs were cast in a bench mould, the veneer or coloured plaster being laid in first, and then backed up with coarse plaster, bedding in thin pieces of slate to strengthen and keep them from warping. They were cast with a groove round the edges to form a key for fixing. The fixing was done by inserting painted iron clamps into the upper edges of the slab, and screwing into horizontal wall battens. The joints were bedded with coloured plaster as the work proceeded, and were finally polished. Several houses in Charlotte Square, and other parts of Edinburgh, designed by the brothers Adam, are enriched with this work. Many of the City Guilds Halls in London are decorated with scagliola, notably the Goldsmiths' and Fishmongers', also the Royal Exchange. St Mary's Church, Islington, has some fine yellow antique plaster on its walls, and St Philip's, Regent Street, London, has some scagliola columns, made with strong timber cores to carry a weight. St Pancras' Church contains some fine imitation verd antique columns, while in a church at Grinstead, at the chancel and altar steps, there are some of inlaid scagliola bearing inscriptions.

Octagon and round scagliola columns, in imitation of porphyry, are formed on stone cores at Raby Castle. The walls of the hall and staircase at what was once Crockford's Club-House, St James's, were done upon slate slabs, $\frac{1}{2}$ inch thick, sawn on the surface with cuts about $\frac{1}{8}$ inch deep to form a key for the scagliola. The slabs were then screwed on to the walls and polished. One of the first specimens of scagliola was executed at Northumberland House, Charing Cross (now the site of the Grand Hotel). The walls of the staircase were giallo antique, relieved with Corinthian pilasters in verd antique and bronzed capitals. These pilasters were removed and fixed in a house in Hamilton Place by Messrs Bellman, Ivey, & Carter. The music gallery was formed in porphyry. The Duke of Sutherland's town house, originally built for the Duke of York, is rich in scagliola. The staircase walls are in giallo antique, the architraves and fluted columns supporting the roof are in granite, and the balustrade richly moulded in brocatello. Some slight idea may be formed of the gorgeous splendour of this apartment by conceiving a room 50 feet square with the walls, galleries, and columns rising with a richly coloured and highly polished surface. All this work was restored in 1895 by the same firm. Scagliola has also been used for floors in some London buildings, also at Sion House, Isleworth, "where," it is said, "a floor that had been down for seven years was taken up and replaced with one richly inlaid, and composed entirely of plaster." Scagliola floors were also laid in Crewe Hall, Cheshire.

About sixty years ago large quantities of scagliola wares were sold in auction rooms. Pedestals for busts and statues, table tops, vases, brackets, slabs for cabinets, caskets, found a ready sale, until imitators of the art, combined with cheap labour and materials, brought the true scagliola into disrepute, and finally drove it out of the market.

The most profitable part of the manufacture of scagliola then, as it always will be, was for the execution of work in large masses. Scagliola is still in use for architectural purposes, principally for columns, pilasters, pedestals, wall and other surface embellishments; but the demand is

limited, owing partly to its price, and partly to its true merits being practically unknown to many. Its use is almost confined to club-houses, a few private mansions and public buildings, one of the latter being the Albert Hall, where the columns are scagliola formed in plaster, and the Corinthian capitals are in Keen's cement polished white. This work was done by A. Gaul since dead, the modelling being by the author. Recent works are in Windsor Castle, Fulham Town Hall, City Bank, New Travellers' Club, St Ermin's Mansions, London; Court of Justice, York; Theatre Royal, Cheltenham; County Council Offices, Derby; Law Courts, Dublin. These works were all executed by Messrs Bellman, Ivey, & Carter, London.

Scagliola is one of the most beautiful parts of decorative plaster work, and it is regrettable that there should not be a greater revival of such a charming and beautiful art. Its limited use in recent times is greatly owing to its manufacture being restricted by rules and rigid methods and even prejudices, and being confined to monopolists, who kept the method secret until it was looked upon as a mystery, which greatly enhanced its cost. But through the information now at hand, combined with a little practical experience and enterprise, there is no valid reason why architects should not adopt it for second or even for third class buildings. It possesses great beauty, and is capable of affording grand effects and the richest embellishments in architecture. Scagliola, in skilful hands, can be produced in every variety of colour and shade, in every possible pattern, in every conceivable form and size, from a paper weight to the superficial area of a large wall. It can be made at a price that would enable it to take the place of the most durable material now in use. Experience has proved that it will last as long as the house it adorns, and with an occasional cleaning, it will always retain its polish and beauty. It has been produced in past days in our own and other lands, and carried to such high excellence, that many of the precious marbles, such as jasper, verd antique, porphyry, brocatello, giallo antique, Sienna, &c., have been imitated so minutely, and with such an astonishing degree of perfection, as to defy detection. It will not only retain its polish for years, but can be renovated at a much less comparative cost than painting and varnishing marbled wood, or plaster work. It is cheaper and more satisfactory to use scagliola in the first instance than to go to the expense of plastering walls, columns, &c., with Keen's or other kindred cements, used for their hardness and ready reception of paint, which are to be afterwards marbled and varnished. Both are imitations, but painted marble can never be compared with scagliola, which has the look, colour, touch, and polish of the more costly natural marbles.

VARIOUS ARTIFICIAL MARBLES.—Various patents have been taken out for the production of artificial marbles, having for their bases plaster of Paris. These patents will be briefly mentioned here.

EVAUX'S ARTIFICIAL MARBLE is composed of plaster mixed with albumen and mineral colours, the ground being zinc white. Rowbotham also employed plaster and albumen soaked in a solution of tannic acid. Lilienthal makes an artificial marble with Keen's cement, slaked lime, and curdled milk.

PICK'S "NEOPLASTER."—This composition was patented in 1883, and is composed of 75 per cent. of plaster, mixed with felspar, marl, coke dust, and pumice-stone. Guleton and Sandeman patented an artificial marble in 1876. It is composed of Keen's cement backed with fibre, and soaked or brushed on the back with a solution of asphalt. The slabs were made in glass moulds. Laroque's patent marble is formed of plaster and alum gauged with gum water, the veining being done with threads of silk dipped in the required colours. The backs of the slabs or panels are strengthened with canvas.

MURO MARBLE is composed of a mixture of Keen's and Martin's cement in equal proportions,

made into a paste, with a solution of sulphate of iron and a small quantity of nitric acid in water. The slabs are dried and tarred at a temperature of 250° F. for about twenty hours, and when cool are rubbed, coloured, varnished, or japanned, as required. There is another patent formed of plaster gauged with a solution containing tungstate of soda, tartaric acid, bicarbonate of soda, and tartrate of potash. Another is composed of Keen's cement 10 parts, ground glass 1 part, and alum $\frac{1}{2}$ part, dissolved in hot water.

GUATTARIS MARBLE is obtained by transforming gypsum (sulphate of lime) into carbonate of lime (marble). There are two methods. The first consists in dehydrating blocks of gypsum, and then hardening by immersion in baths containing solutions of silicate of soda, silicate of lime, chloride of lime, sulphate of potash, soda, acid phosphate of lime, &c. The blocks are cut into slabs or carved before being put into the bath. The second method consists in dehydrating the gypsum, and bathing in some of the above chemicals. They are then dried and burnt at a red heat, and allowed to cool. After a second burning and cooling, the products are ground as for plaster. This powder is called "marmorite." The marmorite is gauged in a trough with some of the water from the baths as above, kneaded into a paste, and the colours added and mixed. The paste is then put into moulds and pressed, and when set they are taken out, dried, and finally polished. Mineral colours are used. Yellow and its tints are obtained with citrate of iron dissolved in oxysulphate of iron, sulphate of cadmium, chloride of yttrium, chromate of lithium, and yellow of antimony. Red and its tints are obtained with dragon's blood, sesquioxide of iron, mussaride red, and sulphate of didymium, and the salts derived from it, which give a rose colour. Azure blue is obtained with sulphate of sodium mixed with acetate of copper and tartaric acid and oxide of cobalt. Green and its tints are obtained with verdigris, hydrochlorate of cobalt. Black is obtained by pyrolignite of iron reduced by boiling in gallic acid with sirco black. Black marble is also obtained by immersing gypsum blocks or slabs or the cast marmorite in a hot preparation of bitumen. During this operation the dehydration of the material under treatment is accomplished, and the bitumen not only penetrates the mass, but fills up all the pores and spaces evacuated by the water which was contained in the material treated, and a hard mass of brilliant black is obtained in every way equal to Flanders marble. It is said that the above imitation marbles are largely used in Florence.

C. Warren, a London plasterer, and A. Gaul, a Scotch plasterer, were past masters in the art of scagliola. The most recent makers are the Plastic Marble Company. E. Robbins patented several improvements in the manufacture of Marezzo. Some of the above patents have been worked with more or less success, while some ended at the Patent Office. The most prominent scagliolists of the present day are Bellman, Ivey, & Carter, of London. This firm, under the title of Bellman & Ivey, was formerly one of the leading firms of master plasterers in London, and did many fine plastering works in England. These scagliola artists have no patents, but simply work on the lines herein set forth, and their works stand unrivalled for general superiority and artistic finish.

SCAGLIOLA MANUFACTURE.—Scagliola can be made *in situ* or in the workshop, according to the requirements of the work; but in either case it is necessary that the workplace should be kept at a warm temperature, and the work protected from dust or damp atmosphere. The plaster should be the strongest and finest in quality, and free from saline impurities. It should be well sifted to free it from lumps or coarse grains, which otherwise would appear as small specks of white in the midst of the dark colours when the polishing is completed. Glue water should be made in small quantities, or as much as will suffice for the day, as it deteriorates if kept too long. Glue tends to harden the plaster, and gives gloss to the surface. Unfortunately it is also the cause of its

subsequent dulness and decay when exposed to moisture and damp air, hence the necessity of using the best glue, good and fresh glue water. If scagliola is required to be done *in situ* on brick walls, the joints should be well raked out and the walls well wetted. This gives a good key, stops the excessive absorption, and partly prevents the evil effects of saline matters, that are found in most kinds of new bricks. These saline matters are the principal cause of subsequent efflorescence which sometimes appears on plastic surfaces, and is so unsightly and disastrous to surface decorations. Saline matters are also caused by acids, used in the manufacture of some cements. Saline is also found in mortars made with sea water, or with unwashed sea sand. These impurities can be avoided by careful selection, mixing, and working of the materials. Brick walls for scagliola should be allowed to stand as long as possible, and wetted at intervals. This allows more time for the saline to exude and be washed off. The exudation may be hastened or the salts absorbed and killed by brushing the walls with a solution of freshly slaked hot lime. This is allowed to stand until dry, and then cleaned off by scrubbing with warm water and a coarse broom. If space permits, a wall battened and lathed is the best preventive. Scagliola slabs, screwed to plugs or battens, are protected from saline and internal damp.

Iron columns to support overhead weights, and fixed as the building proceeds, are often covered with scagliola. If the work is done *in situ*, the iron core is surrounded with a wood skeleton and strong laths, or painted wire lathing. Two wood templates are cut, equal to the lower and upper diameters of the columns, and one fixed at the top and bottom of the shaft. The groundwork is then ruled fair with a diminished floating rule. This gives a guide and equal thickness for the "scag" — the trade abbreviation for scagliola stuff.

The floating coat is composed of the best and strongest plaster procurable, and gauged as stiff as possible with sufficient strong size water, so that it will take from twelve to twenty hours to set. The floating is generally brought out from the lath in one coat. A tenth part of well-washed hair is sometimes mixed with the gauged plaster, to give greater toughness and tenacity. The surface must be carefully scratched with a single-pointed lath, to give a sound and regular key for the scag, which is laid on in slices, and pressed and beaten with a stiffish, square-pointed gauging trowel, somewhat like a margin trowel. The scag is laid about $\frac{1}{4}$ inch fuller than the true outline, and when set, the surface is worked down with a "toothed plane." This plane is similar to that used by cabinetmakers for veneering purposes. The irons are toothed in various degrees of fineness, and set at an angle of 70° . If the columns are fluted, a half-round plane is required for the flutes. As the planing proceeds, the outline is tested at intervals with a rule, as a mason does in using a straight-edge when working mouldings. A planed or chisel-cut surface shows up the grain and figure of the marble much better than if ruled. A rule is apt to work out or otherwise spoil the figure of most marbles. The beating on the slices may disturb the figure of the marble at the outer surface, but if the scag is gauged stiff, the inner portion will be intact, hence the advantage of planing. To obtain greater cohesion between the scag and the floating, the latter is brushed with soft gauged stuff just before each piece of the former is laid. The scratching is also filled up at the same time, so as to obtain the full power of the key with the least amount of pressing on and beating the scag slices in position. When the shaft is planed, the wood collars are taken off; then the base and necking moulding, which have been previously cast, are screwed in position, using plaster coloured the same as the ground of the marble for the joints. When dry, the whole is stoned and polished. Pilasters or other surface work done *in situ* are executed by similar processes. Cast and turned work should always be supported by strong wooden frames, formed with ribs, and covered with $\frac{1}{4}$ inch to $\frac{1}{2}$ inch thick sawn laths. The strength of the frames is regulated according to the position and purpose

of the intended work. For example, a column with base placed on a square pedestal would not require so strong framing as the pedestal which has to support the column and base; also, being on the floor level, it is more exposed to contact and possible pressure. Framing is also necessary for fixing purposes, and to allow for the work being handled freely when being moved from the workshop to the building, and when being fixed. Small work may be made without framing. Turned columns are framed in two different methods, each way being for a special purpose. If it is an "independent column," or in other words a completed column, not intended to surround a brick or iron core, the frame is made strong and in one piece. If a "case column," which is intended to surround a brick or iron core, the frame is made lighter and thinner, and in such a way as to admit the column to be cut either in two equal parts, or with one-third out, or just as much as will allow the larger part to pass over the iron core. Care must be taken that the inner diameter of the skeleton frame is greater than the diameter of the iron core. This is to allow for fixing. The outer diameter of the frame is made about 1 inch less than the finished outline of column, to allow $\frac{1}{2}$ inch for the core and $\frac{1}{2}$ inch for the scag. The two parts of the frame are fixed with wood pegs (not nails), so that they may be sawn when the column is cut into halves. This is not done until the column is polished and ready for fixing. The parts are best separated by cutting with a thin and fine-toothed saw. The thinner the cut, the better the joint. The two parts are fixed on the iron core with brass screws or clamps, from 3 to 4 feet apart, and the joints made good with coloured plaster as before. Sometimes a zigzag joint is made, the one side fitting the other, to give the marble or figure a more irregular and natural appearance. The joints are then stopped with various tints, these being the same gauge as used for the face.

Sometimes the framing is made longer than the shaft, so as to project at each end. These projecting parts are used as fixing points for screws, and binding round with hoop-iron before the plinth and cap are fixed. These parts protect the edges of the work while being moved and fixed. Considerable skill and patience is required to make a strong joint, well polished, and imperceptible to the eye. The frames are made with solid ends, with a square hole in each to fit the spindle. The solid ends are cut out of inch deal, and are used to keep the skeleton firm and in a central position when the spindle is turning on the bearings. One of the ends is fixed to the flange of the spindle with screws. If a case column is being made, the solid ends are taken off before the column is cut; but they form permanent parts of the framing for an independent column. The mould is fixed at one side, and level with the centre of the spindle, which is the centre of the column's diameter. Care must be taken that the profile of the mould plate to the centre of the spindle is one-half of the required diameter at each end of the shaft. Vases are generally made without wood framing. They are turned on a spindle with a plaster core screwed to the flange in the form of a parabola, to give the form of the hollow inside. On the core a coat of scag is laid and allowed to set. This is scratched to give a key for the coarse plaster which forms the body of the vase. This is formed to the desired outer profile by means of a mould fixed on the outside, and muffled to allow for a thickness of outside scag. When the core is run, the muffle is taken off, and the scag laid, keeping it about $\frac{1}{4}$ inch thicker than the true profile, to allow for turning and stoning. When the scag is set, it is turned, and then the vase is taken off the spindle and plaster core. The spindle hole is used as a key for a slate or iron dowel for fixing the vase on to the square plinth. The vase is then polished. Cheap work is usually run or turned with a mould. This is done to save turning with chisels, but it spoils the true figure of most marbles.

A more recent way of imitating marbles is known by the name of Marezzo, which does not require so much polishing, being made on plate glass or other smooth surface. Keen's superfine

plaster is used. The mode of making Marezzo is described later on. Specimens of the real marbles, to give the colour and form of veining, spots, and figures, will be of great service to the beginner.

MIXING.—Mixing the colours is an important part of scagliola manufacture, and the following colours, mixing, and mode of using, will serve as an index for the imitating of any other marble that is not detailed:—Fine plaster not cement is used for making the best class of scagliola, gauged with size water, which is made by dissolving 1 lb. of best Scotch glue with 7 quarts of water. (This is known in the trade as “strong water.”) The stuff, when gauged, will take about six hours to set. All mixing is done on a clean marble or slate slab. One of the principal arts is the mixing, but there are no two men who mix exactly alike, and it is largely a matter of experience. The chopping or cutting into slices with a knife is another important point in the mixing, apart of course from the special colours. Where there are two shades of one colour in any given work, the cutting does not affect their original shades. No dry colour is used, only ground water-colours. The beginner had better experiment with a small sample of “Penzatti” or Penzance marble. With 1 gill of size water, gauge plaster middling stiff, then mix thoroughly with the gauged plaster a little red. Do the same with a little black. See quantities below. Blend this stuff properly by working it on the bench with the hands not tools, then roll it out, and cut it into slices about 1 inch thick. Take up these slices, and part them with the fingers about the size of a walnut, and put them aside, a little distance apart, on a bench.

The veining in this instance is white. Over these little lumps scatter half a handful of crumbs, made by reserving a little of the gauged plaster, and making it crumbly with dry plaster, mixing with it a few small bits of alabaster or marble. Then gauge a little plaster in a basin, and with a tool brush, about 2 inches wide, dip into this gauged plaster, and smudge the little lumps all over with it. Knock these lumps together into a big one, and chop the big lump three times. This chopping means cutting with a knife into slices once, and knocking up again; cutting with a knife a second time, and knocking up again; and then cutting with a knife a third time, when it is finished. This lump is then ready to be cut up into slices, and applied to any purpose required; but in this case, being wanted for a specimen, it is cut into slices about $\frac{1}{2}$ inch thick, and laid close together flat on a sheet of paper, and allowed to remain until set. It is then planed, and when dry polished. This operation is an embodiment of the principle of “scag” mixing nearly from beginning to end, only submitting one colour for another for the various marbles. The mixing is generally known as plain and rich, and may be described thus:—Take a Sienna pedestal, for instance. Two shades of sienna, plain mixing; one or two shades of dark with veining, rich mixing, both done on the same principle as Penzatti. They are cut into slices and laid on alternately. All veining of any colour is done as described above, only modified by the consideration that if strong veining is wanted the stuff must be stiffish, and for fine veining it must be slightly softer. Various-sized measures for the water and scales for weighing the colour should be used. Pats of each gauge should be set aside as test pats to determine when the main portion of stuff is set. It is advisable to number the pats for future reference as to quantity of colours, time of setting, and tints when dry. The various colours and tints are gauged and chopped as previously described, and according to the marble required. The core being laid on the skeleton, and left in a keyed and rough state until dry and expansion ceased, it is ready when set for the scag. The core is now damped and well brushed with the white or other vein that has to be made. The veining is gauged thin, and being brushed and laid in the core, will tend to make the slices adhere better, and fill up the interstices caused by the jagged edges of the cut slices. The slices are then taken and pressed firmly on to the core, arranging in proportion to the figure of the marble. To render the work

more dense, beat it with a flat-faced mallet and a large gauging trowel with a square end. Try the work with a rule to see if the surface is fair. The rough surface should not be less than $\frac{1}{8}$ inch thicker than the true line of the work, to allow for planing and stoning. When required, pieces of alabaster are inserted before the stuff is set. Metallic ores are used in some marbles, also pieces of granite and real marble. When the seag is laid, the work is left until set and dry. It is then planed, stopped, stoned, and polished. Columns and circular work are turned on a lathe, and the rough surface reduced to the true profile with long chisels similar to those for turning wood or other materials. This should not be attempted until the materials are thoroughly set.

COLOURS AND QUANTITIES.—The following are the colours and quantities used for various marbles. The proportions of strong water are as near as can be given, but as the strength of glue from which the strong water is made varies, the due quantity should be tested by gauging small pats of plaster to ascertain the time of setting. As the tints of real marble vary in some species, the mixing must to some extent be left to the ingenuity of the workman. With a little practice and perseverance, a careful and observant man will soon succeed in getting the required tints.

PENZANCE MARBLE.—10 oz. of light purple brown to 1 pint. Veining (plain mixing), 2 oz. black to 1 gill; veining (rich mixing), 5 oz. black to $\frac{1}{2}$ pint; veining (rich mixing), 1 oz. black to $\frac{1}{2}$ gill. All liquid measurements refer to strong water.

EGYPTIAN GREEN.—5 oz. black to 1 pint. Veining, $\frac{1}{2}$ oz. green to $\frac{1}{2}$ pint (light shade); veining, $\frac{1}{4}$ oz. green to $\frac{1}{2}$ gill. White the same, black chopped three times; a few black spots same as brown Belge.

BROWN BELGE.—Four shades—1 light purple brown (indigo); 2 middle shades (blue black); 1 very dark shade (vegetable black). Veining, burnt sienna with red alabaster spots—4 oz. (light shade) to $\frac{1}{2}$ pint; 4 oz. (middle) to $\frac{1}{2}$ pint; 4 oz. (very dark) to $\frac{1}{2}$ pint; $\frac{1}{2}$ oz. burnt sienna to $\frac{1}{4}$ pint; $\frac{1}{4}$ oz. black to $\frac{1}{4}$ pint; $\frac{1}{2}$ pint for the grey, with crumbs, and red alabaster spots.

ROUGE ROYAL.—Colour, light purple brown, with a little sienna, and umber, with ultramarine, blue or blue black.

DARK PORPHYRY.—Colour, light purple brown, with black, and a little ultramarine, blue spots, black, vermilion, grey, and a little red.

GREEN GENOA.—2 $\frac{1}{2}$ oz. green to $\frac{1}{2}$ pint (rich mixing); 5 oz. black to 1 pint. Veining, $\frac{1}{2}$ oz. green to $\frac{1}{4}$ pint. White veining the same, with alabaster spots, and black.

VERT-VERT.— $\frac{1}{4}$ oz. green to $\frac{1}{2}$ pint; dark green with sienna; dry green plaster.

DEVONSHIRE RED MARBLE.—All sienna work. *Light Mixing*—1 shade grey; 1 shade lemon chrome; 1 shade light purple brown; 1 shade flesh colour. Veining, burnt sienna. *Dark Mixing*—1 shade light purple brown, with indigo blue in it; 1 shade dark purple brown; 1 shade middling purple brown; 1 shade grey; 1 shade lemon chrome. Veining, burnt sienna, with small alabaster spots.

SIENNA MIXING.—5 oz. sienna to $\frac{1}{2}$ pint, dark shade; 3 oz. sienna to $\frac{1}{2}$ pint, middle shade; 2 oz. sienna to $\frac{1}{2}$ pint, light shade.

GRIOTTE MARBLE.—10 oz. of light purple brown to 1 pint; 5 oz. of dark purple brown to $\frac{1}{2}$ pint, with alabaster spots and crumbs, with dry black. Veining, black; very stiff.

SPANISH BUFF.—Burnt sienna, 2 shades, with large alabaster spots. Veining, white and blue black, with small alabaster spots. Ground with red veins, and small spots.

LIGHT VERD ANTIQUE.—2 $\frac{1}{2}$ oz. green to $\frac{1}{2}$ pint; 1 $\frac{1}{2}$ oz. black to 1 gill; $\frac{1}{2}$ gill black to 1 gill grey shade.

DARK VERD ANTIQUE.—Green spots cut; grey spots cut; black spots with green and grey.

Veining, 2½ oz. green to ½ pint (rich mixing); 2½ oz. dark green to ½ pint (rich mixing), ¼ oz. black to ½ pint (rich mixing).

Plain mixing, same as above, with small alabaster spots, and small black spots.

BLACK AND GOLD.—5 oz. of black to 1 pint. Veining, 2 shades burnt sienna to ½ pint (rich mixing); 2 shades dark sienna to ½ pint (rich mixing); 2 shades light to ½ pint (rich mixing); 2 parts light and grey, with alabaster spots, and crumbs. Veining must be stiff; 3 oz. of black to 1 gill.

WALNUT.—2 parts burnt umber; 1 part rose pink.

VERTA ALPS MARBLE.—5 oz. black to 1 pint. Veining, 1¼ oz. of green to 1½ gills; ¼ oz. green to ½ gill, with black crumbs chopped three times for the ground.

ROSSE DE LA VANTZ MARBLE.—Rich mixing with indigo blue—1 shade light purple brown; 1 shade dark purple brown; 1 shade Venetian red. Veining, black for the ground, and white and green veining for the mixing, with alabaster spots, and crumbs.

POLISHING WHITE SCAGLIOLA.—White scagliola is often made with superfine Keen's cement. A small portion of mineral green or ultramarine blue is added to improve and indurate the white colour. White work requires special care to prevent discoloration or specks. When the work is left for drying purposes, or at the end of the day, it should be covered up with clean cotton cloths to prevent the ingress of dust, smoke, or being touched with dirty hands. The tools should be bright and clean. Steel tools should be as sparingly used as possible. When the cement has thoroughly set, and the work is hard, it is first rubbed down with pumice-stone, or finely grained grit-stone, by the aid of a sponge and clean water, rubbing lightly and evenly until the surface is perfectly true. It is then stoned with snake-stone Water of Ayr, using the sponge freely and the water sparingly until all the scratches disappear. Afterwards well sponge the surface until free from glut and moisture. It is now ready for the first stopping. Stopping is an important part of the polishing process, and should be carefully and well done, to ensure a good, sound, and durable polish.

First gauge a sufficient quantity of cement and clean water in a clean earthenware gauge-pot. The gauged stuff should be about the consistency of thick cream. It is well dubbed in, and brushed into and over the surface, taking care that no holes or blubs are left. When the stuff on the face gets a little stiff, scrape off the superfluous stopping with a hardwood scraper having a sharp edge. Then repeat the brushing but not the dubbing with the soft gauged stuff, and scraping two or three times, or until the surface is solid and sound. The work is now left until the cement is perfectly set. It is then stoned again for the third time with a piece of fine snake-stone, or Water of Ayr stone, and stopped as before, with the exception that the superfluous stopping is not scraped off, but wiped off with soft clean rags. The work is left until the cement is set and the surface dry. It is then polished with putty powder (oxide of tin), which is rubbed over the surface with soft clean white rags, dampened with clean water. In polishing mouldings, the stones must be cut or filed to fit each separate member of the moulding.

POLISHING SCAGLIOLA.—The polishing of scagliola is slightly different. It is first rubbed down with a soft seconds marble grit or gritty stone (say Hare Hill stone), using the sponge and water freely until the surface is true. The grit and glut are cleaned off with a brush and sponge, using plenty of clean water, until the pores are free from grit. The moisture is sponged off, and the work left until sufficiently dry. It is then stopped in the same manner as white work, but using stiff stopping for large holes and steel scrapers instead of wood. The stopping is made with the same kind of plaster, size water, and colour as was used for the ground colour of the

marble that is being imitated. The stopping and stoning are repeated as before, and it is finally polished with putty powder, using pure linseed oil instead of water. The repeated operations of stopping and stoning must not be proceeded with until the previous stopping is perfectly set, and the work dry. A small portion of spirits of turpentine is sometimes added to the gauged coloured stuff to facilitate the drying. The work between each combined stopping and stoning will take from one to five days to dry, according to the size and thickness of the work and the state of the atmosphere. Never dry the work by heat. The thorough dryness and hardness of the work are most essential before proceeding to polish with the putty powder and linseed oil, because any contained damp will work out and spoil the polish. Work not perfectly dry may take a high polish, but it will soon go off when the damp comes through. Columns or large hollow work are not so liable to be affected by the damp, as it may escape through the back; but there must be some opening or ventilation to allow it to finally escape.

If the polishing is well and carefully done, the polish produced on scagliola will equal, if not surpass, that on real marble. Tripoli polishing stone, sometimes called *alana*, is a kind of chalk of a yellowish-grey colour. Water of Ayr stone is also used for polishing. In large work a rubber of felt dipped in putty powder may be used. Salad oil is sometimes used for finishing. Linseed oil makes the hardest finish, and dries quicker.

MAREZZO. — Marezzo artificial marble manufactured from plaster or Keen's cement and mineral colouring matter is made in wood or plaster moulds for moulded work and on slate or glass benches if in slabs. If thick plate glass is used, the worker has the advantage of being able to look through it to see if the figure of the work requires altering. Glass also has the advantage of leaving a smoother and more polished face. All wood and plaster moulds should be got up with a good face, and properly seasoned, to save stoning and polishing the face of the work. Keen's cement may be used advantageously in making Marezzo, especially for chimney pieces, or other works required for exposed positions. Keen's cement for Marezzo should be of the highest class. If the cement is not of the best, it will effloresce, rendering the work of polishing difficult, if not spoiling it altogether. Keen's cement requires no size water, but in gauging either Keen's or plaster, no more should be gauged than can be conveniently used. The quantities of colours, Keen's cement plaster, and size water should be measured, and gauged pats kept for future reference. All gauge-pots should be of earthenware, as they are more easily cleaned out, and do not rust, as is the case with metal pots. All the tools should be kept bright and clean, as when working scagliola.

Marezzo is made in the reverse way to scagliola, as the face or marble is put in the mould first, and the core or backing put on afterwards.

All the mineral colours should be of good quality, in fine powder, and ground in water, known as "pulp." A number of basins should be handy, and there should be a supply of fine twist silk in skeins varying in diameter from $\frac{1}{4}$ to $\frac{1}{8}$ of an inch, and cut into lengths of 14 to 18 inches. For common work, good long flax fibre may be used. Canvas is also required. One end of the silk or fibre skein must be knotted. These are known as "drop threads."

After the moulds are made, seasoned, and oiled, the young hand may begin by trying to make some easy marble, say "St Ann's," for a slab or chimney-piece. Gauge Keen's extra superfine cement or superfine plaster, in a large basin labelled No. 1, well mixing it until about the consistency of cream. This is pure white. Now pour a small quantity of this white pulp into two small gauge-pots, Nos. 3 and 4. Pour a third of what remains in the No. 1 pot into another gauge pot, No. 2. Take some black-coloured pulp, and make No. 1 a blackish-grey. Colour in the same

way No. 2, only very much blacker than No. 1. No. 3 is now slightly tinted with pulp from No. 1. This leaves No. 4 pure white. Then take a skein of twist or threads, dip into No. 4, the pure white, and well charge it by stirring it about with the fingers; take out the threads, taking each end between the thumb and forefinger of each hand, and with the remaining fingers of each hand separate the threads, allowing plenty of "swag," and strike this into the face of the mould, making each stroke at different angles, recharging the threads when necessary. Repeat this process with pulp from No. 3, but in a lesser quantity; then dip your finger ends into No. 2, and fling drops about the size of large peas all over the veining. These drops must be thrown on with considerable force, so as to cut into the veins as much as possible. Dip the fingers into No. 1, and throw on with a considerable degree of force larger drops, and more thickly. Repeat this process again with No. 2, using alternately from each gauge-pot until you get a uniform thickness of surface "scag", about $\frac{1}{8}$ inch in thickness. Now run a trowel over this to lay down any ridges. Cover the work with a piece of canvas, laying it evenly, smoothly, and without wrinkles. Be careful to put the canvas in the proper place, as moving it would spoil the lines of veining; then spread a quantity of dry coarse Keen's lightly over the entire surface. This will absorb any superfluous moisture through the canvas. After the canvas and coarse Keen's have lain from ten to twenty minutes, or according to the stiffness of the gauge of the marble, the canvas and coarse cement are carefully lifted off. Should any portion of the face of the scag leave the mould, and adhere to the canvas, it is taken off and put back in its place in the mould. The whole surface is now trowelled to render it dense and hard. The moisture should be sufficiently absorbed, or the trowelling may spoil the figure. The proper absorption of the moisture by the dry cement through the canvas, and well trowelling, are most essential to good work, ensuring hardness and density.

The core or backing is now made by using the coarse Keen's previously used for absorbing the moisture from the face, gauging it with some fresh coarse Keen's as stiff as possible. This is laid on as thick as required. If the face of the scag should be very dry, spread a little thin coarse gauged Keen's, so as to give a perfect cohesion between the marble and the backing. The flat surface of the backing should always be ruled or floated straight with a uniform thickness, so as to give a true bed for the cast when it is taken out of the mould, and laid on a bench ready for stoning, stopping, and polishing. This can be done as soon as it is thoroughly set and hard, and in the same manner as scagliola.

Marbles having long stringy veins require a different method of putting in the veins. Take the skeins, or "threads," by the knot with one hand, and thoroughly saturate them with the veining mixture, and run the finger and thumb of the other hand down the threads to clear them of any excess of veining colour with which they may be charged. Then give the end not knotted to your partner, holding the knot in your left hand. Pull the threads asunder, so as to take the form of the veins of the marble you are copying, then lay them in the mould, leaving the knots hanging over the edge of the mould, or at least visible, to facilitate their removal when required. The threads should be arranged on the mould so as to take the form of the veining. The other coloured materials are then thrown upon the thread veins, which quickly absorb the colouring matter from them; care being taken that the various colours are thrown or dropped from the finger tips, to form the figure of the body of the marble that is being copied. When the mould is sufficiently and properly covered with the marbling, take hold of the knots and withdraw the threads. These should be cleaned by passing down the finger and thumb for future use, saving the superfluous stuff for filling up any holes in the marbling. The absorption by the use of canvas and dry coarse Keen's, and the filling in of the backing or core, is then proceeded with as before described.

Granites, porphyries, &c., are made in a different manner. For porphyries with white and black specks, make a slab of white Keen's about $\frac{1}{8}$ inch thick, and another in black, the same thickness. When they are set and hard, chop them into small pieces, then run them through a sieve, having a mesh to let through the pieces of the required size only. The pieces retained in the sieve can be broken and sieved again. The whole is now sieved again through a smaller mesh, which retains only the size wanted. The refuse can be used for small work or backing up. When the gauged stuff for the facing is mixed of the required tint—a reddish-brown, damp the black and white specks, so that the moisture be not absorbed when mixed. Then mix the black and white specks with the gauged colour by means of a trowel and rolling, care being taken not to break the edges and faces of the black and white specks. When it is well mixed, lay it on to the face of the mould about $\frac{3}{16}$ inch thick, pressing it as firmly and evenly as possible. Then absorb the moisture by means of canvas and dry coarse Keen's; trowel it well to give density, and fill in the backing or core as before. For "Rouge Royal," "Verd Antique," &c., requiring large white patches of irregular size, the sieving can be dispensed with. The white pieces are broken haphazard, and pieces of alabaster can also be inserted in these, and many other marbles, due regard being given to the size and quantity, so as not to produce an unnatural effect. The remainder of the figure is formed with the "drop threads," and the other colours being thrown on.

From this description of Marezzo, the workman will understand that in the case of marbles classed as "Breccias," such as "Rouge Royal," "Black and Gold," &c., having patches and rough jagged veins in them, he must have flat pieces of the required colour previously made and broken up, or alabaster, as the case may be, inserted into them, and the veining done with the "drop threads," and that fine or long veining threads are not required; that unicoloured marbles require no veining threads; that the long veined marbles require the long threads, and in some cases the "drop threads" as well, and that granites, porphyries, &c., require no threads; that black is difficult to make owing to the pure white cement requiring so much colour; and finally, that in all cases, whether Marezzo or scagliola, the polishing is done in a similar manner, whether using plaster or Keen's cement.

The details given must be carefully followed to produce work artistic in figure and appearance. The directions for making "St Ann's," so far as manipulation is concerned, apply to all others. A little patience, practice, and perseverance will soon give confidence and expertness in producing sound scagliola and Marezzo.

GRANITE FINISH.—Granite finish is a peculiar finishing coat of plaster, which is sometimes used in some districts of America to imitate granite. For granite finish, first render the walls with hydraulic lime, and when nearly dry lay with a thin coat of the same material but coloured light brown. Then while this coat is still moist splash the surface lightly with white stuff, then with black stuff, using only half as much as used for the white splashing, and finish by splashing with red stuff, using as much as used for the white stuff. The red stuff is best applied by dotting the surface with a small brush charged with the coloured stuff. After these coloured lime stuffs are firm, but not set, the surface is carefully trowelled, using the minimum of water so as not to mix the various coloured stuffs. The surface is sometimes left in a rough state, or as left when splashed. After the surface is firm, it is set out and jointed to represent blocks of granite.

GRANITE PLASTERING.—Granite plastering is a method, introduced by the author, to imitate granite. This mode of imitating granite is based on the scagliola process. It is also somewhat similar to the granite finish, and gives better and more reliable results. The method of executing granite plaster work is as follows:—First select the most suitable lime or cement for the situation,

such as Portland cement or hydraulic lime for exterior work, and Parian or other white cement for interior work. Having decided on the material, gauge three different coloured batches, one white, one red, and one black, taking care that the stuff is gauged stiff and expeditiously so as to obtain a hard substance. The material is coloured to the desired shades, as described for scagliola or coloured stuccos. When gauged, the stuffs are laid separately on a bench and rolled until about $\frac{1}{4}$ inch thick, and when nearly set they are cut into small irregular cubes and allowed to set and harden. The wall is then floated, ruled fair, and the surface keyed, and when set it is laid with a thin bedding coat of similar stuff used for the floating, but coloured light brown. The coloured cubes are then mixed together in due proportions, and gauged with a portion of the light brown coloured stuff and laid on the thin coat while it is still soft. The whole is then firmly pressed with a hand-float until a close, compact, and straight surface is obtained, taking care when pressing the stuff not to break the cubes. After the stuff is set, and perfectly dry and hard, the surface is rubbed down and polished, as described for scagliola or for marble plaster. The bedding coat should be sufficiently thick to receive the coloured cubes, otherwise the larger cubes will project at parts, and cause extra labour in making a uniform and straight surface. Unless the cubes are fairly level when pressed, the surface will have a spotty appearance, besides being more difficult to polish. Where expense or time is a consideration, a striking appearance is obtained at less cost than polished work, by simply finishing the surface with a cross-grained hand-float, and a semi-polished surface is obtained by trowelling, or by scraping the surface with a joint-rule. Grey or light-coloured granites are imitated by altering the colours of the cubes and the bedding coat as desired. Bold and striking effects on wall surfaces can be obtained by a combination of different coloured granites, laid out in bands and borders. The effect can be increased by the introduction of borders in sgraffito, with the bands in granite plaster.

CHAPTER XVI.

FOREIGN PLASTER WORK.

INTRODUCTORY—SARACENIC—PERSIAN—SPANISH AND MOORISH—INDIAN (ONE-COAT, TWO-COAT, AND THREE-COAT WORK)—CHINESE—ITALIAN—ITALIAN STUCCO—FRENCH—CARVED PLASTER—GERMAN—GERMAN MORTAR—AUSTRIAN—BELGIAN—RUSSIAN.

INTRODUCTORY.—The heading of this chapter may perhaps need a few words of explanation, seeing that the plaster work of Italy and France, named above, has been treated of and illustrated in the Introductory Chapter written by Mr G. T. Robinson. It should, therefore, be explained that whereas in that chapter all work is dealt with from the historical point of view, in the present—although some historical notes will be found—the main intention is to give an account of the craft as it has been, and is now practised, in the various countries brought under consideration.

SARACENIC PLASTER WORK.—Saracenic or Arabian architecture dates from the time of Mohammed in the seventh century. Saracen, which simply means Eastern, was the universal designation of Moslems in the Middle Ages, the word conveying the two ideas of oriental and mediæval. Saracenic architecture spread to Syria, with Damascus for its centre. Another form of it is seen in Morocco, Persia, Armenia, and even Turkey in Europe. This architecture is distinguished by the form of arch known as the "horse-shoe," which is supposed to be an invention of the Eastern Christians.

The Mohammedan law placed stringent limits upon the form of ornament to be used in the endless designs for mosaic, marquetry, or stucco work. There must be no image of any living thing, vegetable or animal. Naturally these imperious limitations conduced to the formation of a unique style of decoration, vegetable forms being excluded for the first time. Mere curves and angles or interlacings had to bear the chief burden of a design, but this was distinguished by a lavish variety of colour. The lines, curves, and angles gradually developed into a characteristic species of tracery or interlaced strap-work, very agreeably diversified by the ornamental introduction of inscriptions. The gorgeous domes and minarets, and the decoration of their surfaces with ingeniously complicated and geometrical figures cut in stone, plaster, or wood, the whole being beautifully coloured and gilded, are also distinctive features. The mosque at Medina, built in A.D. 622, had partitions constructed with wattles and plaster. The Mosque of Ibn-Tulun, Cairo, was begun in A.H. 263, and finished in A.D. 878. The court in this mosque is surrounded on all four sides by arcades of painted arches resting on plastered brick piers. The capitals, like the rest of the building, are plastered and enriched with buds and flowers. The spaces between the arches are partly filled in with windows and engaged columns. The surfaces are enriched with a series of plaster rosettes worked by hand, and the inner parts with a knop and flower pattern. Illustration No. 156 depicts these arcades. It will be seen that portions of the wall plaster are broken, but the whole is in fair preservation, considering it has been exposed for a thousand years.

The decorative borders in the Mosque of Ibn-Tulun are the earliest examples that have been found of the geometrical designs and scroll work which are so characteristic of Saracenic ornament. With the exception of the grilles and the fountains, the entire mosque is built of burnt brick, plastered on both sides. Domes are generally built of brick, not moulded to the curve, but simply laid, each tier a little within the lower tier, so as to form the proper curve. The plaster which coats most of the domes inside and out conceals the slight irregularity of the brick-work. Wooden frames are also used to support the lighter plaster domes, somewhat like the framework in our modern fibrous plaster. The

surfaces of the domes are ornamented in various ways. Some are covered with an intricate geometrical design, with a star centre, others with bands of zig-zags or chevrons, running horizontally round the dome from base to apex. Others again are fluted, and some are covered with arabesques arranged in large outlines, which form a sort of diaper.

The Sultan Hasan's Mosque contains some beautiful plaster decorations and Kufic friezes (Kufic is a form of Arabic writing). Illustration No. 157 shows a portion of a Kufic frieze from this mosque; and No. 158 shows a portion of a frieze without an inscription) in the Mosque of En Nasireeyeh. The Mausoleum of Kalaum (A.D. 1284) is the most perfect example of plaster ornament in Cairo. The borders of the arches supporting what was once the dome, the borders of the clerestory windows above, and an infinity of other decorations, are wholly

of plaster, and nothing more delicate and lace-like can be imagined. The bud surrounded by leaves forms a central idea, but it is developed until scarcely recognisable. The designs are chiefly characterised by a broad treatment of large foliage, worked round into a scroll-like continuous pattern.

Plaster in this Eastern work is evidence of early date, though it would be difficult to assign a satisfactory reason for it. Nevertheless, as a fact, the earlier mosques are generally decorated with plaster work in many varied and rich designs. The Ashar, built in 971, is adorned with Kufic friezes

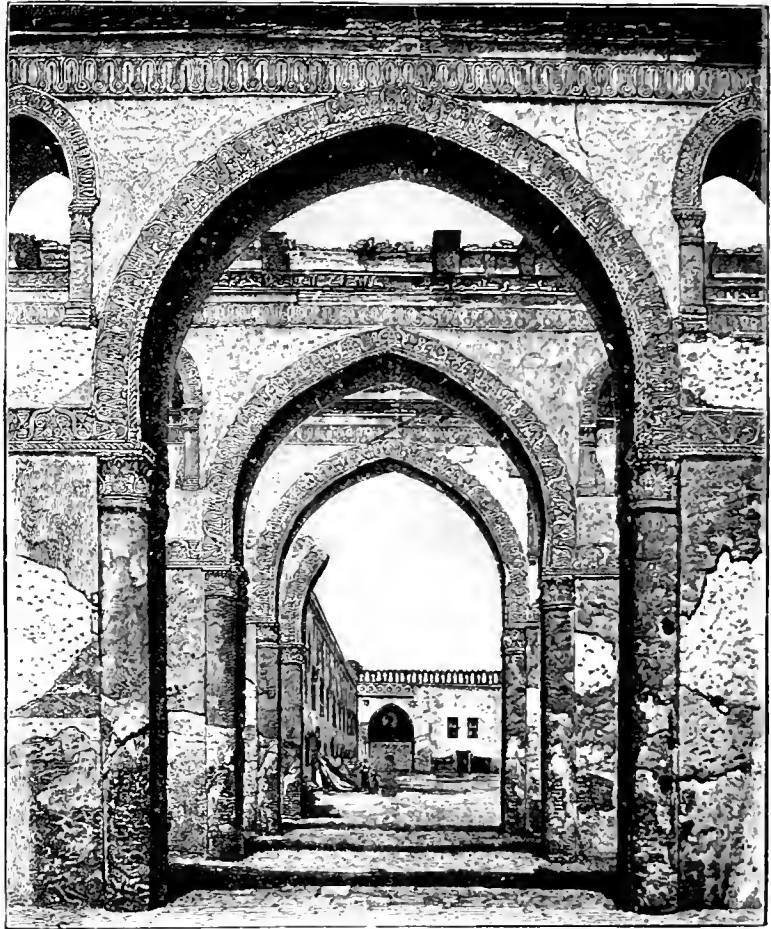

NO. 156.—ORNAMENTAL PLASTER WORK ON THE ARCADES IN THE MOSQUE OF IBN-TULUN, NINTH CENTURY.

and arabesque ornament, all in plaster work. The plaster work of Cairo is chiefly surface work, put on with tools while the stucco was in a moist state, and never cast in moulds. The difference is very striking, the softness and flexuous grace of the hand-worked patterns being in strong contrast to the hard uniformity of mechanical castings.

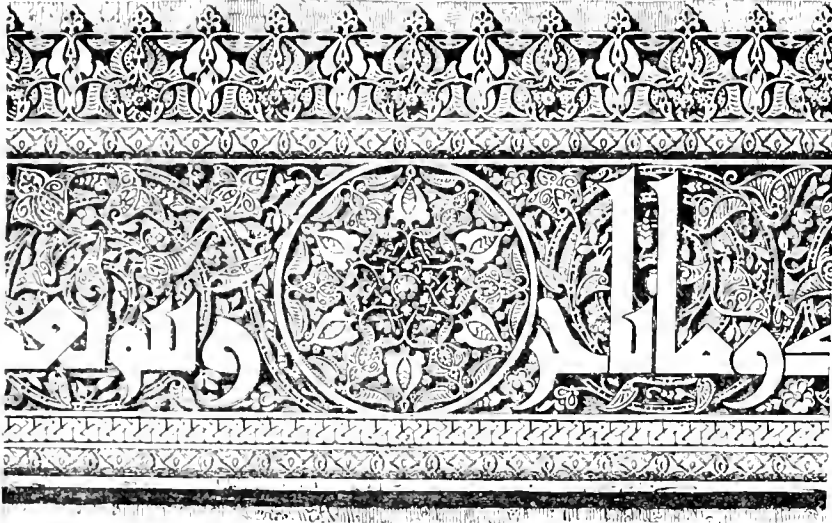

NO. 157.—PLASTER FRIEZE IN MOSQUE OF SULTAN HASAN, FOURTEENTH CENTURY.

our own fibrous plaster. The panels between the beams are divided into small coffers, and similarly plastered, painted red and blue, with gold and white to give light. All this work is done down and only fixed in its place when finished.

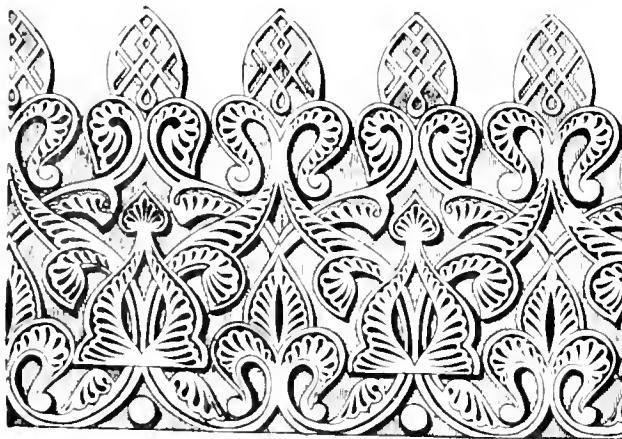

NO. 159.—PLASTER FRIEZE IN THE MOSQUE OF EN NASIREYYEH.

Another mode of decorating ceilings was to nail thin strips of wood on to the joists that form the roof in geometrical designs, and to cover the whole with a thin coat of plaster on which arabesques and floral enrichments were then pressed before the plaster was set. When dry, the whole was painted or gilded. The colours chiefly used are blue and red. A portion of a ceiling, with octagonal coffered panels, from the Mosque of Sultan Kalanoun (fourteenth century) is shown on illustration No. 159. The conjunction of the ceiling with the wall is formed by a stalactite-shaped cornice, as shown on No. 160. An interesting feature in connection with this ceiling is the material used in the formation of the ornament. This is a peculiar kind of carton-

pierre, chiefly made of fibres of palm leaves. Willows, flax tow, and canvas are often found in plaster work in Egypt. A striking example of an arabesque from the great mosque, Damascus, is shown on illustration No. 161, and an Arabian panel on No. 162.

In both mosques and houses the ceilings are often the most beautiful part of a room. The coffered ceilings are formed by the beams, which are sometimes allowed to appear in their natural (half round or round) form and position. In houses the outline of the beams is often preserved to within a couple of feet of the end, when stalactites mask the transition to the square. The beams, whether round or square, are covered with a coating of canvas saturated with plaster like

our own fibrous plaster. The panels between the beams are divided into small coffers, and similarly plastered, painted red and blue, with gold and white to give light. All this work is done down and only fixed in its place when finished. Another mode of decorating ceilings was to nail thin strips of wood on to the joists that form the roof in geometrical designs, and to cover the whole with a thin coat of plaster on which arabesques and floral enrichments were then pressed before the plaster was set. When dry, the whole was painted or gilded. The colours chiefly used are blue and red. A portion of a ceiling, with octagonal coffered panels, from the Mosque of Sultan Kalanoun (fourteenth century) is shown on illustration No. 159. The conjunction of the ceiling with the wall is formed by a stalactite-shaped cornice, as shown on No. 160. An interesting feature in connection with this ceiling is the material used in the formation of the ornament. This is a peculiar kind of carton-

impervious plasters is fully attested by the numerous examples herein mentioned. Another example is the red stucco in one of the chambers of the Pyramids in Egypt, executed about four thousand years ago. Again, the interior of the ancient cisterns at Alexandria are covered with a thick red stucco that is not permeable to water.

A curious use of plaster is seen in the windows of mosques and houses in Cairo. Over the niche of a mosque, and over the lattice wood work of a *meshrebīya* in a house, one generally sees examples of the characteristic stained-glass windows of Cairo. In houses they are generally set in a row, in slight wooden frames over the lattice, to the number of eight or more. The Cairo room in the South Kensington Museum has eleven of these stained windows, which are called in Arabic *kamarīyas* or *shamsīyas*, "moonlike" or "sunlike." They consist of a rectangular frame of wood, about 2 inches broad by 1 thick, and form an oblong about 30 inches high by 20 broad. The frame is filled with an arabesque, floral, architectural,

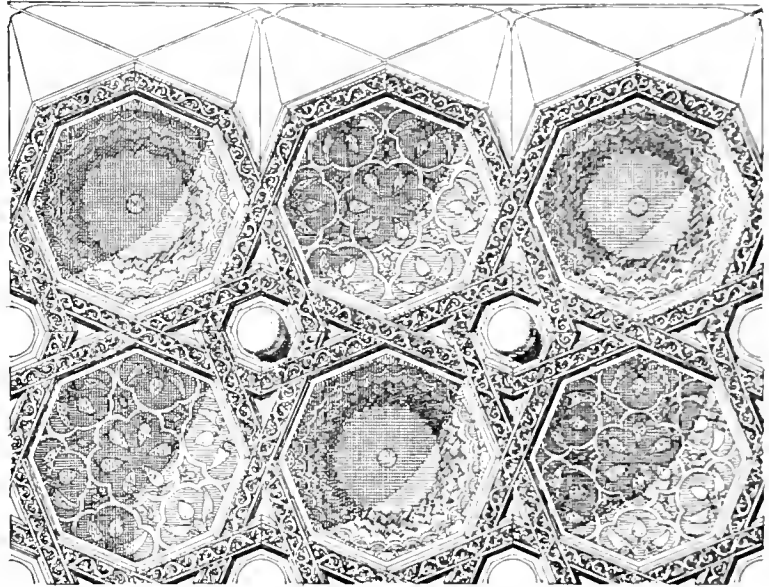

NO. 159.—PORTION OF CEILING, KALANOUH MOSQUE, IN CAIRO, FOURTEENTH CENTURY.

or inscriptional design in open plaster work, the perforations being filled with stained glass. The mode of making these windows is the simplest. A bed of plaster is poured into the frame and suffered to set, and the design is then cut out with a gouge or other tool, after which the stained glass is fixed with more plaster on the outside of the window, which is then put in its place, flush with the inside of the wall, and set in a slight wooden frame with a flat architrave round it forming a margin which conceals joints between the several windows.

A couple of buttons keep the window from falling inwards, while the architrave secures it on the outside. It will be seen that no special skill is required for most of this work. The plaster is easily cut, and the glass requires no fitting, for its superfluous edges are concealed by the plaster. Where the art comes in is in the shaping of the perforations which form the design. The shape and slant of these holes are skilfully regulated according to the height they are to be raised above the spectator, and the thick plaster setting of the bright little facets of glass gives the light that comes through the latter a shaped appearance which is singularly charming.

The material is fragile, but moderate care on the part of the workmen would ensure the safety of the *kamarīya* between its cutting and its placing in the window. The work could be made considerably stronger by inserting a twisted galvanised wire in the outer edge of the plaster while soft, taking care to keep it clear of the perforations in the design. A twisted wire is as strong as three pieces of straight wire of equal thickness and

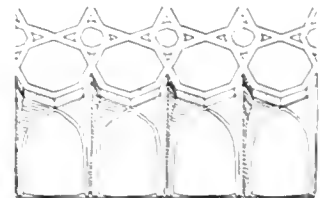

NO. 160.—CORNICE, KALANOUH MOSQUE, IN CAIRO.

length for this purpose. Illustration No. 163 shows one of these curious stained-glass windows. The original of this and others from Cairo are now in South Kensington Museum.

Through the courtesy of Mr C. Purdon Clarke, of the South Kensington Museum, I am enabled to reproduce a portion of very fine plaster work (Plate XLV.) in the mihrab of Abdul-Hacen's Mosque in Algiers, built in 1296. A mihrab is a niche in the wall of a mosque, indicating the position of Mecca, towards which Mohammedans look while praying.

It has already been stated that the Saracenic style of ornamentation extended to Turkey in Europe. Turkish ornament may be described as a modification of the Arabian and Saracenic,



NO. 101.—ARABESQUE FROM THE GREAT MOSQUE, DAMASCUS.

but inferior to it in elegance and refinement. The decoration of the dome of Soliman I. at Constantinople is exceptional in its beauty and excellence of taste. One marked feature in the colour decoration of the Turks is the predominance of green and black. An example of Turkish ornament—a frieze from Constantinople—is shown on illustration No. 164.*

PERSIAN PLASTER WORK.—Although the Persians were a civilised people, very little is known of their ancient methods of building. The Saracens invaded and conquered Persia in A.H. 16 (A.D. 636), in the reign of the Caliph Omar, but the Persian Empire, which extended to the

* For some of the illustrations and notes I am indebted to "Saracenic Art," by Mr Stanley Lane Poole.

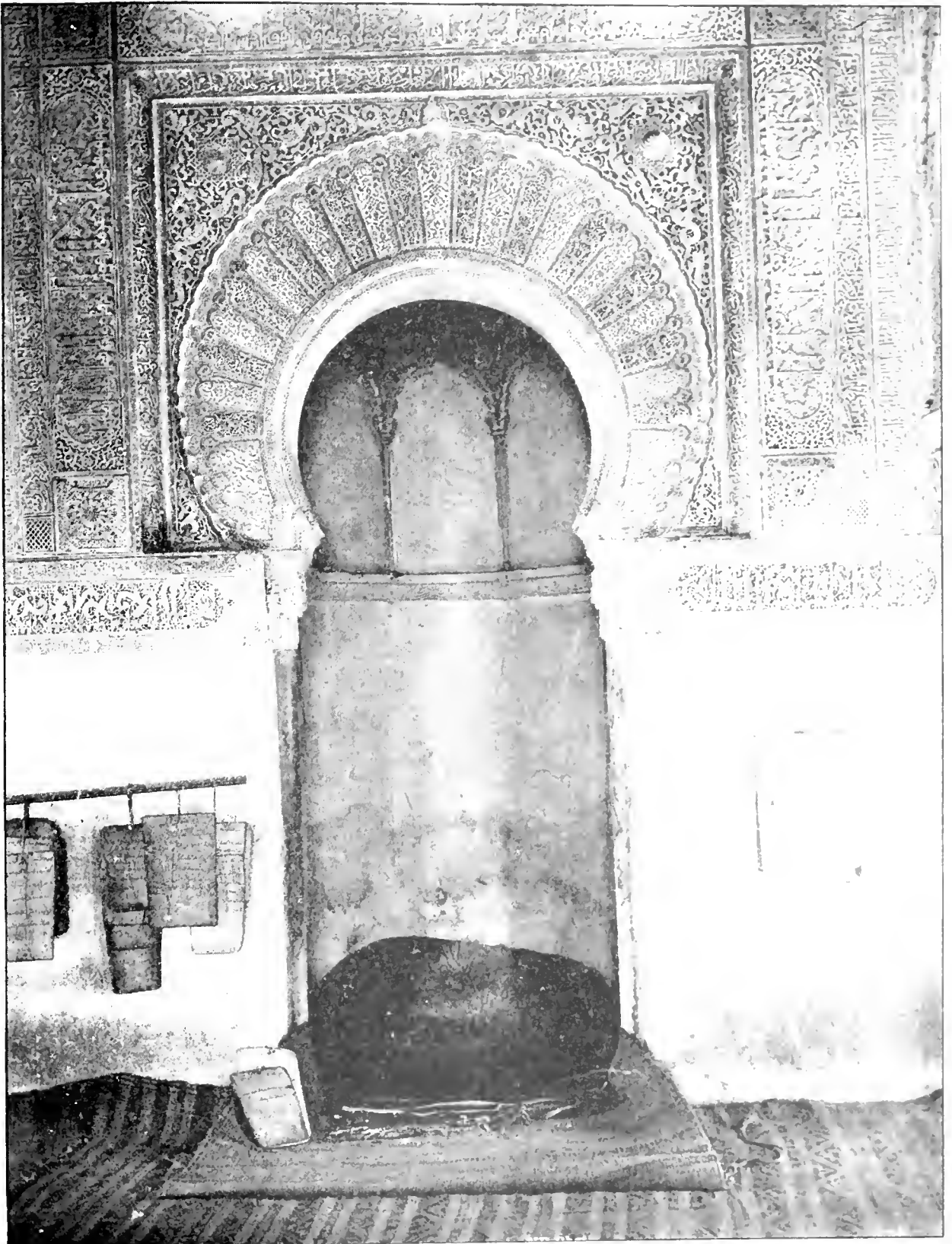

PLASTER WORK OF MEDINA — A. J. HAYES, S.M. — A. 1903.



Oxus and Indus, was not conquered till the reign of Moawia. When the Saracens first invaded Persia they found many magnificent buildings, one of the principal being the palace of Chosroes, which contained many grand halls, finely enriched with plaster work. The city of Baghdad was founded by the Caliph Mansur. The Djüma Mosque at Ispahan is said to have been built by the same caliph. This mosque is about 460 feet long and 400 feet wide, and is richly plastered. The Mosque of Mesdjid-i-Shah was built by the great Shah Abacs I. This mosque is about 420 feet wide and 340 feet deep, and is decorated with highly gilt plaster work. There are numerous other mosques, palaces, and monuments with stalactite domes and cornices, niches, and minarets all plastered, and in

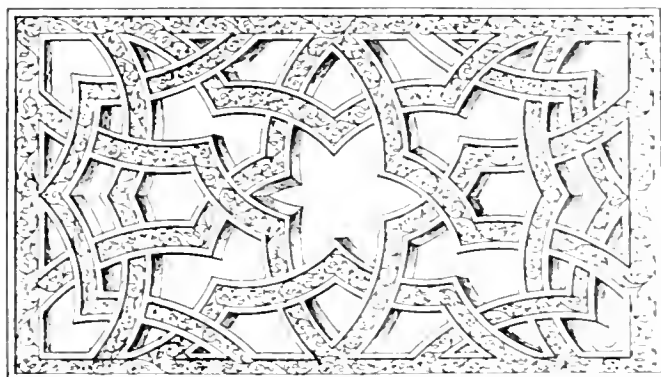

No. 162.—ARABIAN PANEL.



No. 163.—PLASTER AND GLASS WINDOW FROM CAIRO.

some cases further enriched with plaster and enamelled tiles, the constructive and decorative features being their peculiar forms of arches plain and cusped, their domes, niches, and stalactite enrichments which show the wonderful powers and variety of Moslem art.

Mud houses are plastered with a mixture called "kahgill," which is composed of soft mud and chopped straw. The interior of mud houses are sometimes ornamented with hand-work gatch or gypsum, whereby a high finish is produced. Squire, in his "Land of the Incas," describes the palace of Chium, where the adobes, or sun-dried bricks, were covered with stucco, on which beautiful arabesques were produced.



No. 164.—PLASTER FRIEZE FROM TURKEY.

Perrot and Chipiez, in their "History of Art in Persia," state that the Persepolitan ornaments imitated at Ferüz-Abad—an ancient palace of Fars (ancient Persia)—were plaster throughout, and they go on to observe that the extensive use, or it may be said abuse, of stuccoed decoration is a distinguishing feature of Arab architecture. Plaster, when fresh, is soft and malleable in its nature, so that it affords the craftsman an opportunity of showing his dexterity of hand in those singularly delicate quillings, gofferings, fillets, beading, and what not; but there is danger of their merging into mere fineness.

Plaster of Paris, termed "gatch" in Persia, is put to a curious but hideous use in Persia, where it is used for the execution of prisoners. This form of execution is called "gatching," and consists

of a hollow column being erected over a hole about 2 feet deep, so that the hole forms a well into which the prisoner is put. Plaster is then emptied in, and between each boxful water is poured down the well. The gatch then swells, and when it sets it stops the circulation, causing the most excruciating agony and prolonged death. After death a plaster capital is fixed on the column, covering the head of the prisoner.

In Persia, where so much attention has been given to decorative plaster work for both outsides and insides of buildings, honour is given to the plasterer as the most skilled artificer in the building trades, and the position of general foreman and art supervisor is generally conceded to him. In England the position of general foreman or "leading hand" is more often accorded to the carpenter. In Persia the plasterer reigns supreme among craftsmen—the work of other branches in the building arts is covered and embellished by him. In Persia, and even in some other Eastern nations, the

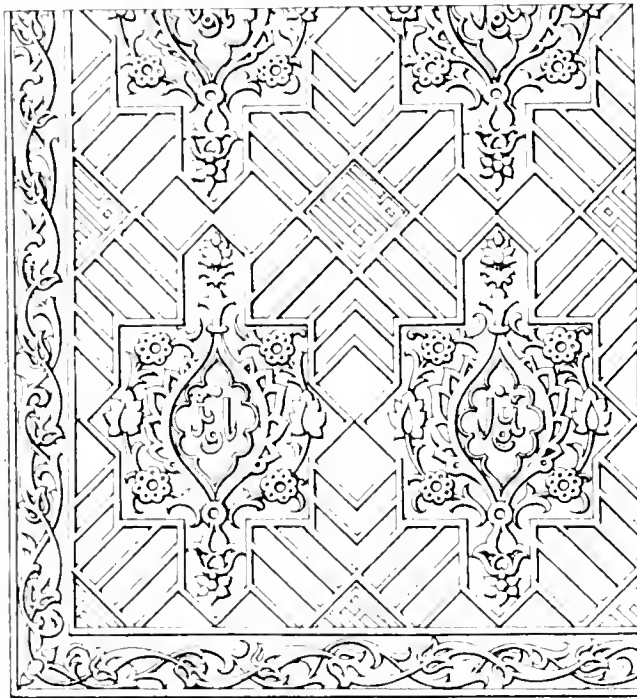

NO. 165.—PORTION OF A CEILING FROM TEHERAN, PERSIA.

interiors and many of the exteriors are covered and decorated with plaster made from the local gypsum. Persian plasterers have no idea of using running moulds for forming mouldings. They literally daub the stuff on until of the required thickness, then work it down and fashion the mouldings with gouges and drags. This method is alluded to in Holy Writ in describing those who cry "peace where there is no peace"—"they do but daub the walls with untempered mortar," illustrating the actual practice of Persian plasterers even at the present day. The Persian plasterers gauge their plaster in a curious way, and one quite foreign to our ideas. The plaster is mixed in a pannikin of water in very small quantities, then worked in the hands by rolling, squeezing, and drawing it out repeatedly—much in the same way as a glazier manipulates oil putty—until it is dead, or the initial setting power is killed. By this process the mass assumes a slight flexibility. It is then dashed on the walls and ceilings, and spread. This is repeated until a rough outline of the proposed work is obtained, after which it is worked as already mentioned. It might naturally be supposed that this inert plaster would never set or become hard. It does, however, attain a considerable degree of hardness, probably due to a reaction in the setting of the plaster caused by the peculiar nature of the crude gypsum. Another cause for a part of its ultimate hardness is the absorption in the brick work over which the plaster is laid. The plaster used for the ornamental work is mixed with a vegetable juice which acts in a similar way to glue water in retarding the setting. The decorative plaster work is done *in situ*.

Examples of eighteenth-century Persian ornament are shown in the accompanying sketches—No. 165 is a portion of a plaster ceiling, No. 166 is a centre-piece, and No. 167 is a panel from Teheran. By the courtesy of Mr C. Purdon Clarke I am enabled to reproduce portions of



PORTION OF A PLASTER CEILING, PERSIA, EIGHTEENTH CENTURY.



the original drawings for plaster work by Mirza Akbar, State Architect to the Persian Court, for a Persian palace erected about 1840.* The first (Plate XLVI.) shows a portion (about one-quarter) of a plaster ceiling, and illustration No. 168 shows a portion of the cornice frieze in the same apartment. Illustration No. 169 shows a portion of a plaster chimney-piece and wall decoration, and No. 170 is a portion of the cornice frieze in the same apartment. The latter sketch is larger in scale than the former. These elaborate but quaint plaster decorations are chiefly modelled by hand and *in situ* as already described. Oval panels and small columns and pilasters are favourite subjects in Persian decorations. The use of plaster for the decoration of chimney-pieces is common in Persian houses.

The late Shah sent some plasterers to the Paris Exhibition in 1878 to erect a pavilion. This had an interesting example of a stalactite dome ceiling. The Persian method of setting out a stalactite dome ceiling is as follows:—The floor of the room is first levelled with ashes or sand. On this a coat of plaster about 1 inch thick is laid, floated, and made fair. On this plaster floor a full-size plan of the ceiling is set out, the working lines being struck with a line blackened with charcoal, in the same manner as our plasterers do on white screeds or ceilings. The plasterers then

cut V-shaped grooves in the plaster, following the black lines and using them as the centres of the grooves. When this is finished, the plaster chippings are swept off, and the floor oiled with hot melted suet. On this mould a coat of plaster is laid, to form the first or lowest plan of the ceiling. When set, it is taken up in sections, and cut into the shapes defined by the projecting ridges. The plaster slabs are fixed with gauged plaster, and further supported with wood and reeds fixed with plaster. The large pendent stalactites are also fixed with plaster and supported with iron chains, which are made rigid by encasing them with plaster. The plasterers work the stalactites by hand to the desired form. The next line plan on the floor is then cast, cut, and fixed in the same way, till the whole series and the ceiling are completed. Their peculiar form of arch, which is somewhat like the four-centred Tudor arch, or involute curve, is set out with a chalk line. A pin to fit the perforation of the reel is fixed in the centre of the small radius, and on this the reel is fixed. A pencil is placed through the loop at the end of the line, and is held by the hand and moved as the line unrolls, until it reaches the centre line. The same process is used for the other side.

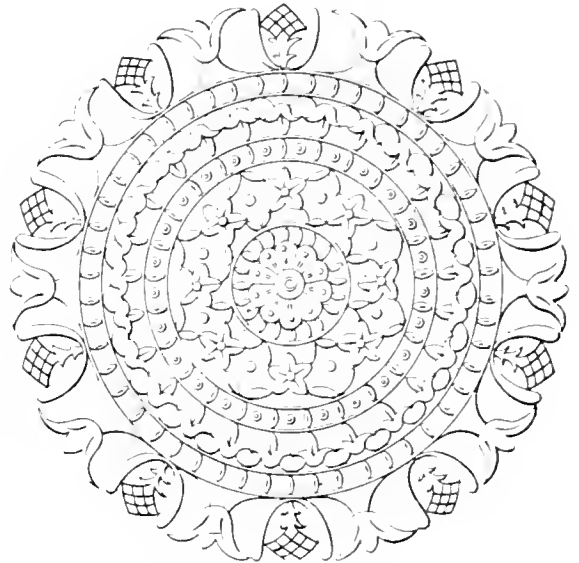

No. 166.—PERSIAN CENTRE-PIECE.

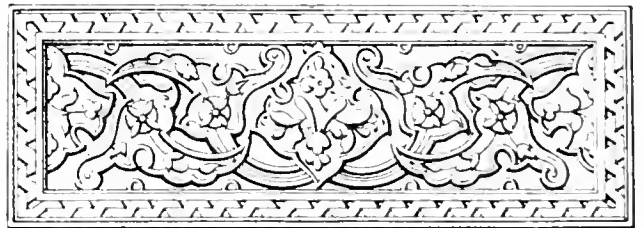

No. 167.—PLASTER PANEL FROM PERSIA.

* These illustrations were traced from the original drawings, now in the Art Library, South Kensington.

SPANISH AND MOORISH PLASTER WORK.—The beautiful plaster work of Spain has a distinct character, being generally carved plaster in flat relief, admirably adapted for the material and the clear fine air of the country for which it is intended. The characteristic treatment of their honey-combed ceiling and diapered wall surface are of unusual interest. The Moorish style of diapering walls with arabesque stucco work came originally from Damascus, and forms a sort of connecting link between the works of the ancients and that of the Renaissance revival in Italy. The Mohammedans being forbidden by their creed to represent the human or animal forms, in ornament adopted a style peculiarly their own, and although thus restricted, they produced a vast variety of fascinating and elaborate designs and created what is known as arabesque ornament. They were the inventors of superposed enrichments and stalactite pendants, by which large flat surfaces of ornament and uniformity of relief and line are symmetrically broken and gracefully accentuated. Their beautiful geometrical tracery is either interwoven with the stiff and angular Kufic, or in the African, or incursive letter-forming inscriptions. One of the most wonderful and beautiful examples of decorative plaster work is that on the walls and ceiling of the celebrated Alhambra of Granada in Spain, which was the palace of the ancient Moorish kings of Granada. It was commenced in 1248 by the Sultan Ibn-ul-Ahmar, and finished by his grandson, Mohammed III., about 1314.

Plate XLVII. shows a portion of the entrance to the Court of the Lions in the Alhambra (so-called from the fountain in the centre supported by these animals). It is a parallelogram of

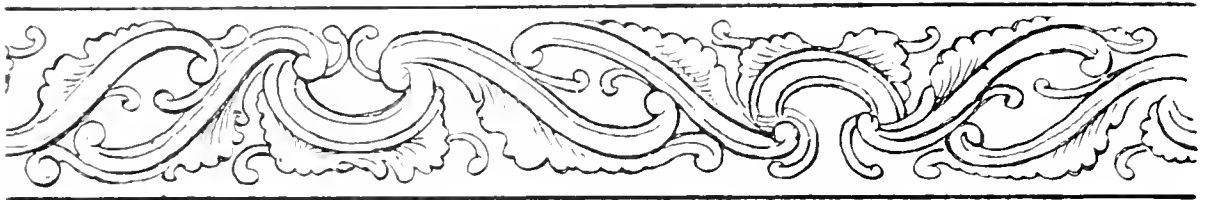

NO. 168.—PLASTER FRIEZE FROM PERSIA, EIGHTEENTH CENTURY.

150 feet by 50 feet, and is surrounded by a portico with small pavilions at each end. The portico and pavilions consist of 128 columns, supporting arches of the most delicate and elaborate finish, still retaining much of their original beauty; the various colours, however, of the ornaments are now wanting. The portion of the entrance shown is from the corridor which separates the Court of the Lions from the Court of the Fish-pond, and the illustration shows a little over one-half of the width. The centre cusp at the top, and abutting on the plain moulding, is the true centre. In order to show the details more clearly the whole height of the entrance is not shown, and is only taken from a little below the capital of the nearest column. A portion of the upper part of the wall is also omitted. A small part of the ceiling between this wall and the next one is shown. The inscription on the band round the spandril of the arch is thus read: "May power everlasting and imperishable glory be the lot of the owner of this palace" (Afr.). "There is no conqueror but God" occurs several times, both in Kufic and African characters. The elaborate cusped and pendentive arches are beautiful and wonderful examples of the plasterer's art and craft.

The ceiling of the Hall of the Bark is a waggon-headed dome of most elaborate pattern. It receives its support at each end from pendentives abutting against the great arches. Illustration No. 171 elucidates the formation of the pendentives. They are of a very curious mathematical construction, and are composed of numerous prisms of plaster, united by their contiguous lateral surfaces, consisting of seven different forms proceeding from primary figures on plan. They

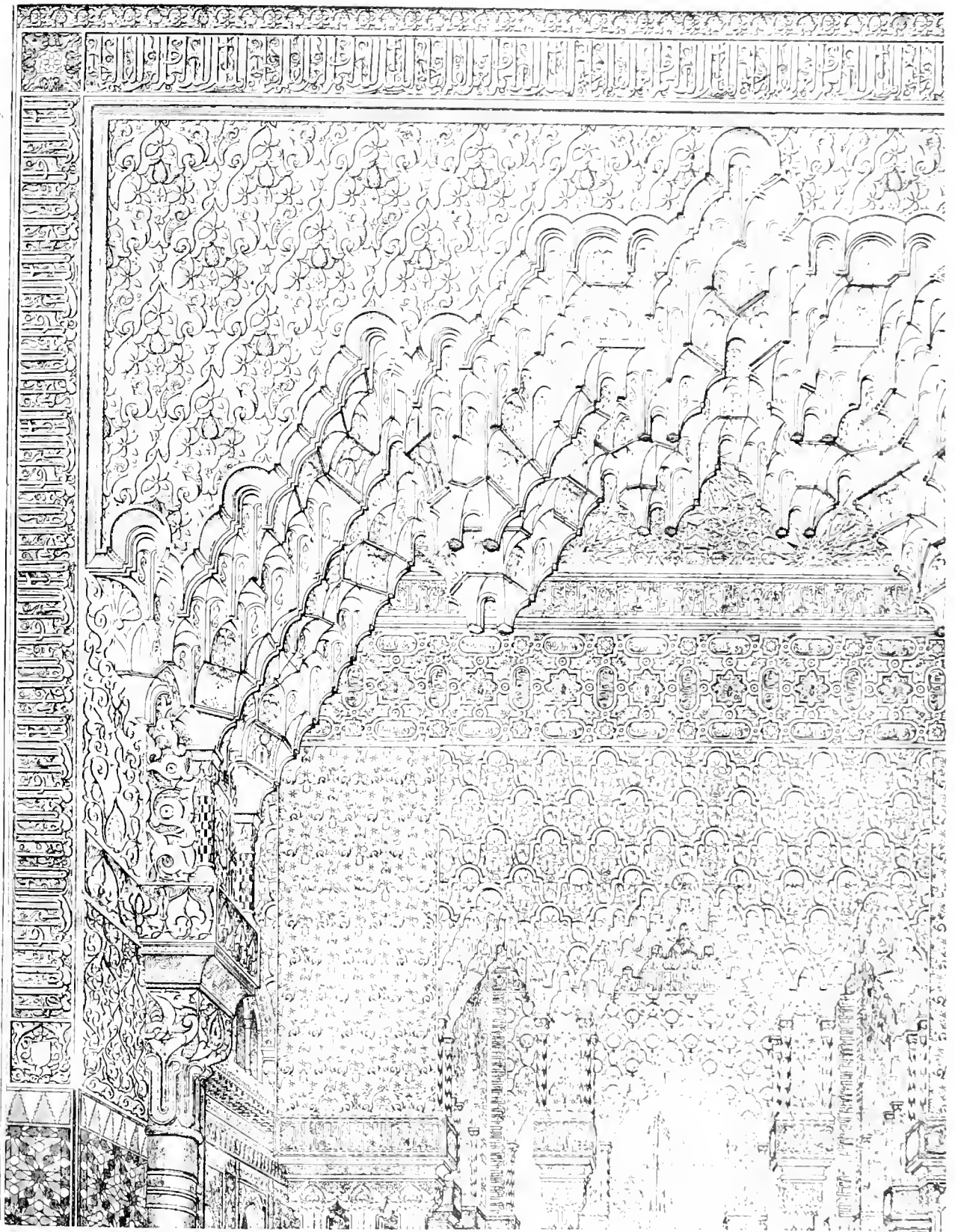

MOORISH PLASTER WORK—ENTRANCE TO THE COURT OF THE LIONS IN THE ALHAMBRA, SPAIN, THIRTEENTH CENTURY.

are the right-angle triangle, the rectangle, and the isosceles triangle, A, B, and C respectively in Fig. 1. In these aa , ab , ac are equal, ba is equal to bb , and the vertical angle of the isosceles triangle (C) is 45° . The figure B has one form in section, the figure A three, and figure C three; the third (C 3) being a rhomboid formed by the double isosceles triangle, as shown in Fig. 3. The curves (lettered X) of the several pieces are similar, by which it will be seen that a piece may be combined with any of the others by either of its sides, thus rendering them susceptible of combinations as various as the melodies which may be produced from the seven notes of the musical scale. The letters on the plan (Fig. 2) and the elevation (Fig. 4) correspond with each other, also the section (Fig. 3).

The conical ceilings of the Halls of Justice, Abencerrages, and Two Sisters, as well as the column capitals and arches of a similar construction, are formed with these plaster prisms. Nearly five thousand enter into the construction of the ceiling of the Two Sisters; and although they are simply of plaster, strengthened here and there with pieces of reed, no part of the palace in the present day is in a more perfect state of preservation. This pendentive construction attests the wonderful power and striking effect obtained by the repetition of the most simple elements.

The arabesque work is executed in pin-point stucco, and unlike the general work, is principally carved, not cast, the original stucco plaque being brightly coloured in the primary hues. The arabesques covering the walls seem to be hand-worked with great care and patience. "The process employed was simple. Preparatory to applying the decoration, the naked walls were divided by lines at right angles, such as artists employ in producing pictures. A series of intersecting segments of circles were then drawn over these, and by their aid the artist could work with quickness and surety. The great instrument of the Moorish artist was the compass, which, however, was not made in the usual way of two limbs of metal joined.

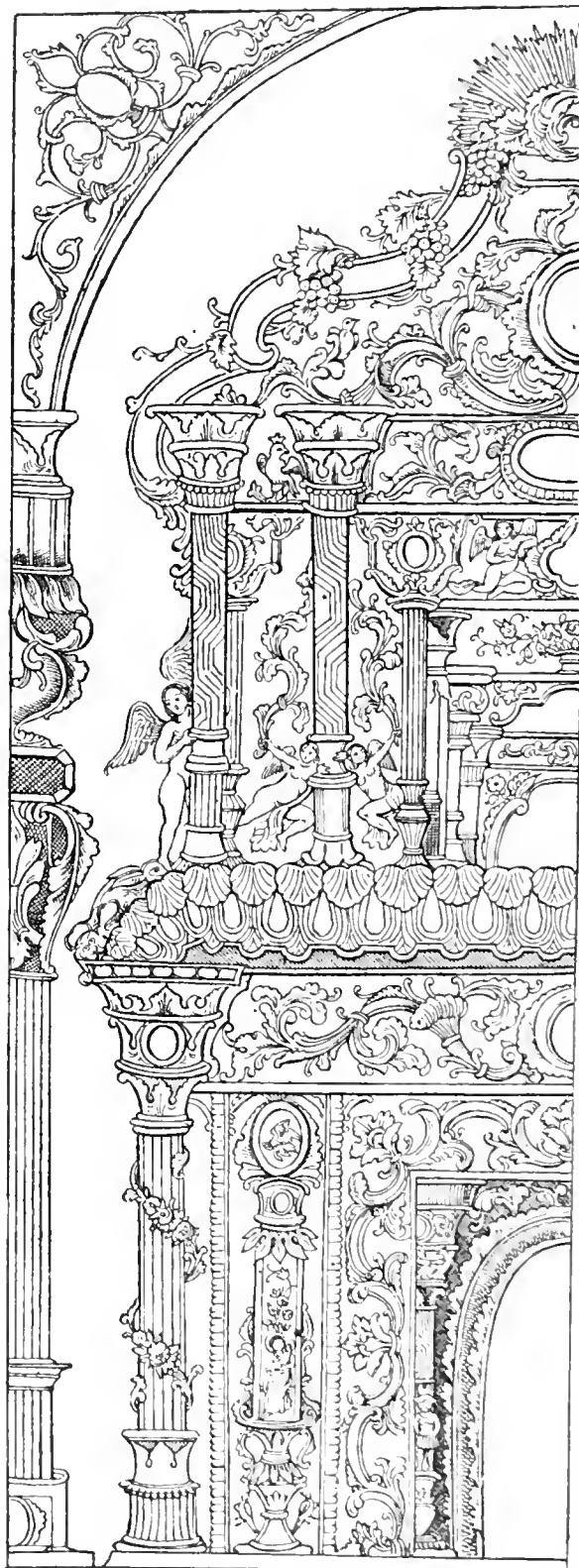

NO. 109.—PLASTER CHIMNEY-PIECE AND WALL DECORATION, PERSIAN, EIGHTEENTH CENTURY.

It was a fixed measure tied by a string, so that for each dimension there was a different compass."

A part of the diaper panelling in the Hall of the Ambassadors is shown on Plate XLVIII. The arches of the Fish-pond are profusely decorated with perforated plaster ornament and inscriptions

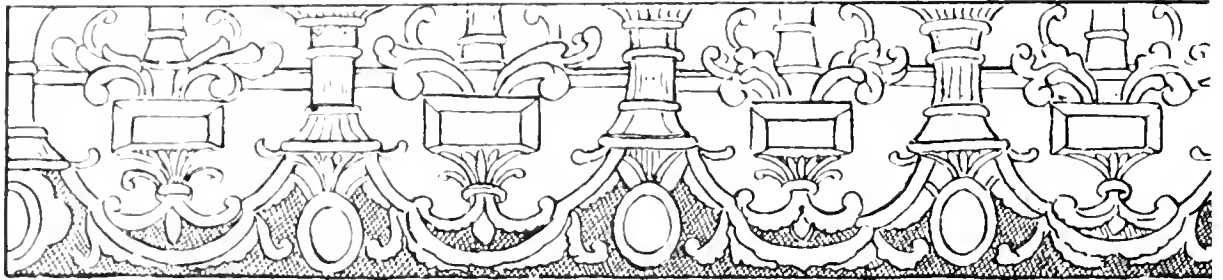

NO. 170.—PLASTER FRITZE, PERSIA, FIFTEENTH CENTURY.

in Kufic characters. Plaster casts from the original works are to be seen in the Alhambra Court at the Crystal Palace, London.⁴

The Moors were always distinguished by the beautiful use they made of plaster. The patterns used are generally such as in stone work would be unhesitatingly attributed to the end of the

fifteenth or first half of the sixteenth century. Mr G. E. Street, when describing Moorish plaster work, says that "plaster may be used truthfully and artistically, and without any approach to the contemptible effect which the imbecility and dishonesty of the nineteenth-century designers of plaster work have contrived to impress on almost all their productions." The walls of the façade of the Alcazar and other buildings in Segovia are diapered in plaster. They are generally tracery patterns of the latest Gothic, left slightly in relief, and repeated over and over again so as to produce a regular diaper throughout. This mode of decoration seems to have been very popular in the fourteenth and fifteenth centuries. Mr Street is of opinion that the diaper work "was executed with a frame cut to the pattern, so as to

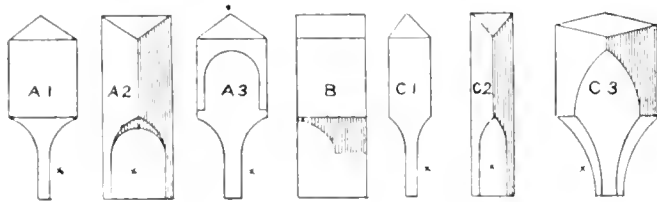

Fig. 3.

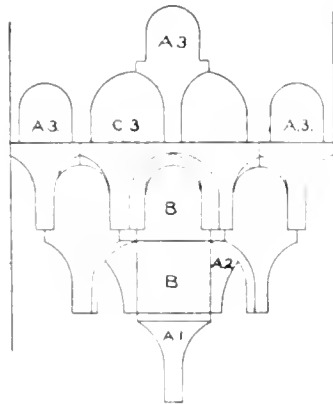

Fig. 4

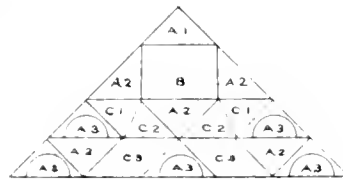

Fig. 2. PLAN

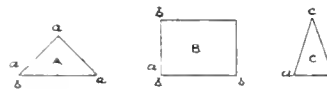
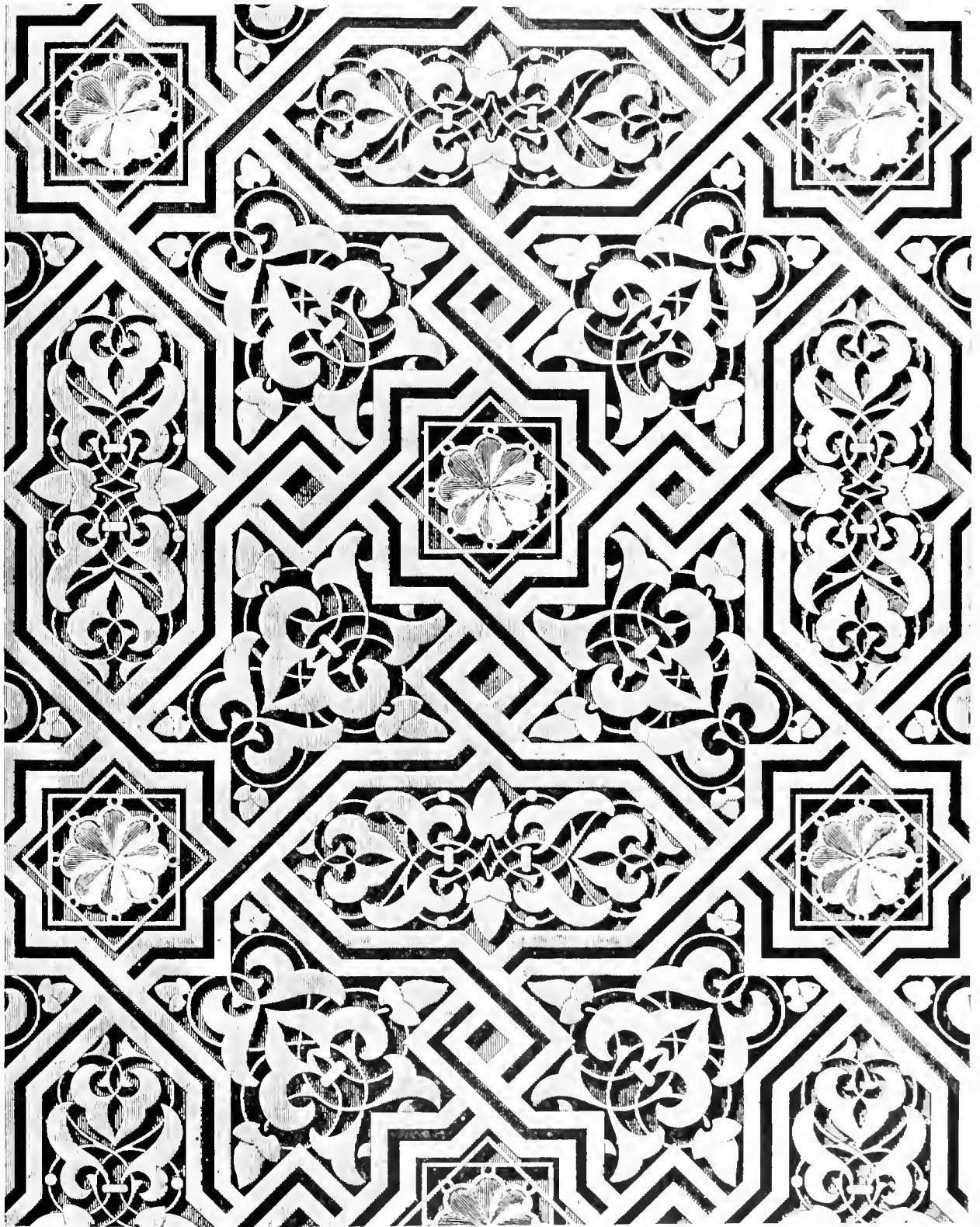

Fig. 1.

NO. 171.—SETTING OFF PLASTER PRISMS FOR PENDENTIVE CEILINGS.

allow of the ground being cut back slightly, leaving the pattern lines formed in the original face of the plaster. This kind of decoration seems to be perfectly legitimate, and here, owing to the care with which the plaster had been made and used, it had stood remarkably well,

⁴ The sketches and part of the description of the Alhambra are taken from Owen Jones' grand work on that wonderful building.



DIAPERED PLASTER PANELLING IN THE ALHAMBRA, SPAIN. THIRTEENTH CENTURY.

though most of the patterns (that he saw) had evidently been executed in the fifteenth century." In the front of the Alcazar these plaster patterns are carried not only all over the plain face of the walls, but also round the towers and turrets of the angles, so that the smallest possible amount of wrought stone is used.

The front of a private house near San Esteban is another fine example of the same kind of plaster work. The patterns in the plaster are three in number, the first carried from the stone plinth up to the sills of the principal windows, where it is cut by a narrow band of ornament, acting as a string course to divide it from the second pattern, which is carried up to the eaves, the tower being covered with a third diaper rather less intricate in design. Near this house is a tower in the walls even more worthy of notice. It is of very considerable height, quite plain in outline, and only pierced with one or two square-headed windows, but surmounted by a fine parapet supported on machicoulis. The whole tower is built with bold stone quoins and horizontal bands of brick work, each band two courses in height, at intervals of about 3 feet. Between these bands the walls are plastered and diapered. Here, as in the other house, only two or three patterns are used, but greater judgment is shown in the repetition for the greater part of the height of the same pattern, which is changed at last near the top where it is desirable to emphasise the work. Most men having three patterns to use would have divided them equally, but the real artist gives all their value to his simple materials by not doing so. The construction of this tower led naturally to its decoration. The wrought stone at the angles, the rough stone work of the walls, and the occasional bonding courses of brick, were all used simply as the best materials for their respective parts; and the rough stone work being plastered and diapered, gave a richness and polish to the whole work which it would otherwise have wanted, whilst it in no degree destroyed the air of stability of the wall, which is secured by the obviously constructional arrangement of the stone and brick. The above description of this highly interesting constructive and decorative work is noteworthy, and will afford many suggestions in plaster decoration in combination with stone and brick work.

Madrid, being a comparatively modern city, has little plaster work of interest. There is a growing fashion of diapering houses all over with a kind of thirteenth-century painting on plaster, but the work is not nearly so effective as the incised plaster work previously mentioned. When Philip II. was building the Escorial at Madrid, he sent for Pelligrino to assist in the plaster decorations. Pelligrino (who was with Primaticcio at Mantua) gave a Renaissance character to the incised plaster work which had since the Moorish occupation prevailed in Spain. Toledo possesses many rich and interesting examples of plaster work.

In a synagogue founded in the twelfth century, but seized in 1405 by the Toledans, and dedicated as a church under the name of Sta. Maria la Blanca, the application of plaster work is conspicuously exemplified. There are eight horse-shoe arches springing from octagonal columns in the arcades, and the whole of the columns and capitals are executed in brick, and finished with plaster. The capitals are very elaborate, but slightly varied in design. All Moorish decorative work seems to have been executed in the same way. This was of very fine quality, and was evidently cut and carved as if it had been stone, and seldom, if ever, stamped or moulded according to the practice of the present day. The consequence is that there is endless variety of design everywhere, and any amount of undercutting. There is another synagogue in Toledo, erected in 1366 by Samuel Levi, a rich Jew. After the expulsion of the Jews from the kingdom in 1493, it was converted into a church called "Del Transito." The building is a simple parallelogram, 76 feet long by 31 feet 5 inches wide. The lower portion of the side walls is quite plain, but above it is very richly adorned with plaster work. There is first a broad band of well-relieved foliage,

with Hebrew inscriptions above and below it, and above this, on each side, an arcade of nineteen arches springing from coupled columns (with elaborate capitals), eight of its divisions being pierced and filled with very elaborate lattice work. The end wall to within 7 feet of the floor is covered with rich patterns, inscriptions, and coats of arms. The arcades are all cusped in the usual Moorish fashion, the outline of the cusps being horse-shoe, but without an enclosing arch. Plate XLIX. shows a portion of one of the side walls, with the inscriptions, arcade, and lattice work. It will be seen that the main ornament on the wall and the capitals vary in design, thus adding to the general effect.*

Many of the façades and walls of buildings in other towns in Spain have their plain surfaces covered over with incised patterns cut into the plaster; the roughened surfaces of the abraded ground giving in that bright climate, when bounded by the clean-cut shadow or brightly-lit edge of the salient parts, a different tone from that of the main surface, forming, in fact, a coarse sgraffito. Some of this work is coloured, which adds to the general effect.

INDIAN PLASTERING.—The history of the plaster work of Indian fabrics, even of modern date, is involved in obscurity. There is ample evidence of the artistic ability of Indian plasterers to be seen in the numerous palaces, temples, &c., to be found in all the principal parts of India. The walls of the rooms at Kandahar, Afghanistan, were plastered with gypsum, and decorated along the cornices with arabesque patterns stamped on whilst the plaster was moist. On this decoration, in its yet moist state, coarsely pounded tale was pounded on, which during daylight shone like frosted silver, whilst by lamplight it sparkled like diamonds. In the North of India a lime known as "kankar" is generally used for plaster work. Burnt brick when ground to powder—known as "sukhi"—is, as a substitute for sand, mixed with kankar lime.

In the Ganjam district of the Madras Presidency the natives rarely use sugar in common building mortar, but in Chumam the plasterers use for ceilings, walls, and verandah pillars a good deal of sugar (*cheener*). The materials used are 100 lbs. of good slaked shell lime, the white and yolk of 16 eggs, 1 gallon of fresh butter milk, 25 lbs. of fine sifted clean sand, 1 lb. of fresh butter, 1½ lbs. country sugar, and 50 lbs. of water. These materials are all well mixed together, placed in a covered tub, and allowed to remain for three days before using. When this is set it takes a high polish, and has a marble-like appearance, and it will stand washing with soft soap water. The Madras Cathedral is a good example of native plastering, which is done in one, two, or three coats, as required. The following is the general mode of Indian plastering:—

ONE-COAT WORK.—The mortar is composed of 1 part of shell lime and 2 parts of clean river sand. This is well mixed and beaten up with a wood beater, and allowed to stand until required. When wanted for use, it is knocked up with water in which jaghery has been dissolved in the proportion of ½ lb. of jaghery to each gallon of water. The mortar is then laid on with a trowel, and floated with a flat wood rule. It is then finished with a wood rubber, sprinkling the face of the work with water in which pure shell lime has been mixed. The rubbing or hand floating is continued until a smooth face is obtained. This one-coat work is scarcely ½ inch thick when finished.

TWO-COAT WORK.—The first coat is laid as in the former process, only no lime water is used for hand floating, and the surface is left rough to receive the second coat. The first coat is allowed to stand for one or two days (according to the state of the atmosphere), and while semi-dry the

* The illustration of plaster decoration in the synagogue is from a photograph kindly placed at my disposal by Mr C. Purdon Clarke, F.S.A. Many of the foregoing descriptions of plaster work are from "Gothic Architecture in Spain," by George E. Street, A.R.A.

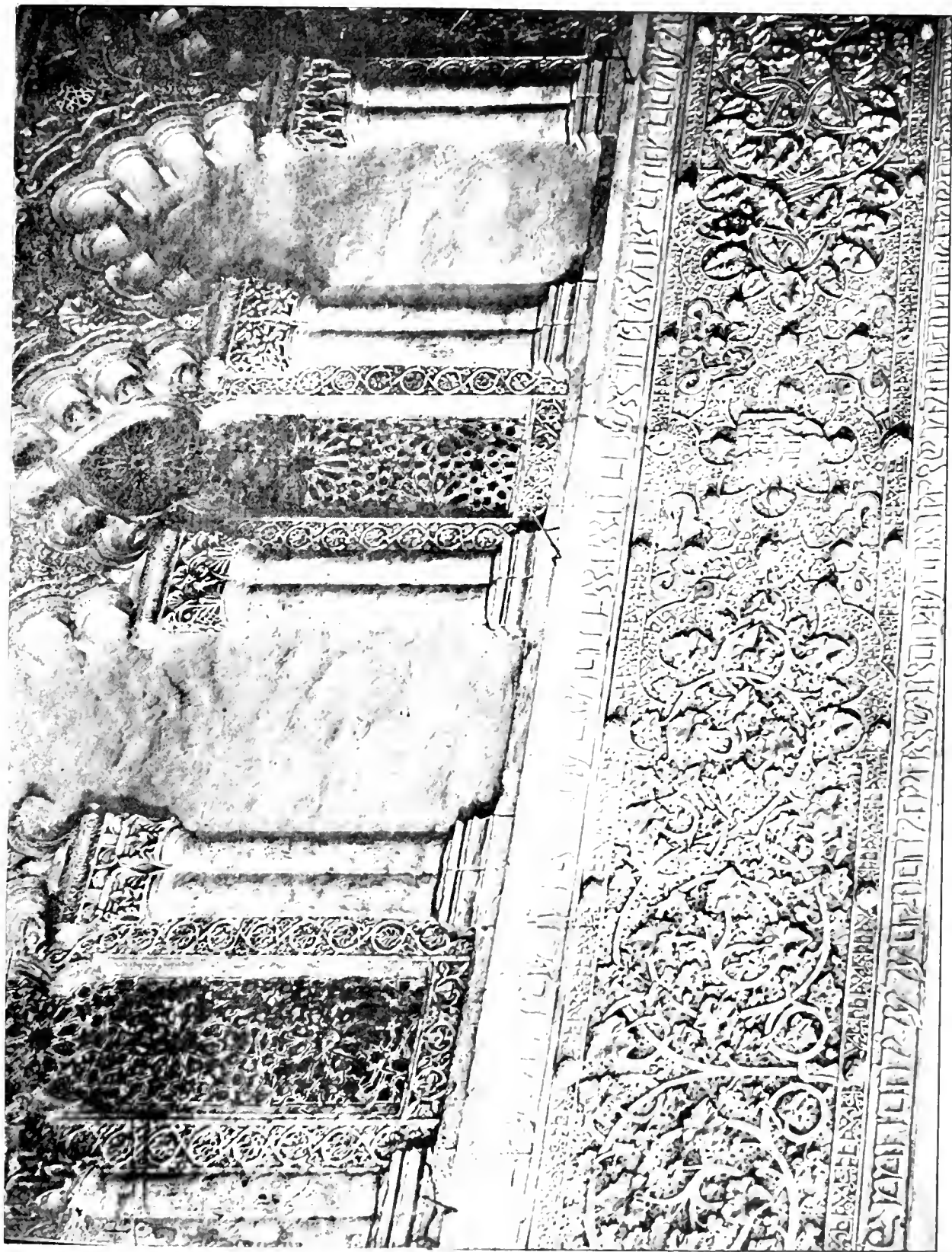

PLASTER DECORATION IN A SYNAGOGUE, NOW A CHURCH CALLED DEL TRASSUDO, IN FORTINO, 1506.

second coat is laid on. This is composed of 3 parts of shell lime and 1 part of fine white sand. These are gauged with the jaghery water, and allowed to stand as before. It is then ground on a large flat stone by means of a small stone roller until the gauge is reduced to a very fine paste, something like our fine putty. It is laid on about $\frac{1}{4}$ inch thick with a broad wooden hand float, and floated with a trowel used in a similar manner to hand floating. It is next polished with a crystal or smooth stone rubber until it has a fine smooth polished face. Afterwards it is sprinkled with very fine powdered ballapam (soapstone or steatite, which is kept in a cloth or fine muslin bag. The sprinkling or dusting is done to increase the whiteness and assist the polishing. No more is laid on than can be done in one day, as it may harden too much during the night to be polished the following morning. The work is polished and dusted until it is quite dry. A number of plasterers are employed in the polishing, so that the work in hand can be finished the same day as laid. The drying is further hastened by frequently wiping with soft cloths. When this class of work is finished it has a very fine appearance.

THREE-COAT WORK.—The first coat is done the same as for two-coat work, with the exception that it is allowed to stand for two weeks or until dry. The second coat stuff is composed of 1 part shell lime and 1 part of well-washed river sand. These are well beaten up in a wooden box or trough. The first coat is slightly damped with clean water, and the second coat is laid on about $\frac{1}{4}$ inch thick with a wooden hand float, and then rubbed or hand floated until the work is consolidated and even on the face. After standing a day or two, or until dry, it is ready for the third coat. This is made in two operations, the materials for the first being 4 parts of shell lime and 1 part of well-washed white sand, mixed with jaghery water, and reduced by grinding (as before described) to a very fine putty paste. This is allowed to stand until the other portion of materials are mixed. This is done by placing in an earthenware jar the whites of twelve eggs, a half gallon of whey with the curds, and well mixing, after which this is added to half a gallon of the putty paste, and rubbed together until the whole is thoroughly incorporated and reduced to a fine thin paste. It is then covered up and allowed to stand until the extra fine stuff for the second operation is gauged. This is simply pure lime ground to a very fine powder, mixed with water in a trough and well stirred until it is of the consistency of cream. This is kept covered up until wanted for use. The first gauge is now well stirred and laid on the second coat, a bare $\frac{1}{4}$ inch thick, with a broad hand float. It is then gently floated to lay it fair and firm, and next brushed over with fine lime cream, and floated gently with a hand-float first, and then more firmly with a trowel, until it attains a slight hardness. It is polished with a crystal or white pebble, being sometimes first rubbed with a piece of steatite. The crystal is generally about 3 inches long and $1\frac{1}{2}$ inches wide, and has a perfectly smooth face. While the polishing is in progress, the dusting with the powdered soapstone is frequently used, and the moisture wiped off with soft dry cloths. The polishing is continued until the work is perfectly dry. This beautiful marble-like plaster stands all the changes of the Indian climate, and is exceedingly durable.

The success of this process depends on the proper quantities and gauging of the different materials, especially for the third coat, on its being floated carefully, and on the polishing with the crystal and powdered soapstone (with intermediate absorption of moisture by cloths) until the work is quite dry. As in our own country, the process and proportions of materials vary more or less in the different parts or presidencies of India.

Steatite or soapstone pulverised to a fine powder has been used for plastering walls and ceilings. It takes a high polish, is pearly-grey in tint, and gives a fine surface for painting either in oil or water colour, and is hard, non-conductive, and non-absorbent. It can be washed, and when

subject to heat, moisture, and chemical fumes, it gives no smell, and does not turn yellow with age.

Besides the tale already mentioned for obtaining sparkling surface effects on plaster work, ground glass is also used for a similar purpose. The ground glass is sprinkled over a damp cloth, which is then turned over, so that the surplus or dry glass falls off; then the glass side of the cloth is applied to the ceiling while the plaster is moist, and the under side beaten or pressed until the glass is impressed into the plaster; the cloth is then taken off, leaving a uniform coat of glass on the surface of the plaster. Another mode of using glass in combination with plaster for decorative purposes is as follows:—Glass cubes of various sizes, forms, and colours are inserted by hand into the soft plaster. By this process a curious combination of coloured surfaces with glittering effects is obtained.

The following composition for indurating and protecting plaster exposed to the weather is frequently used in India, viz., 3 parts of linseed oil boiled with one-sixth of its weight of



NO. 172.—INDIAN CENTRE-PIECE.



NO. 173.—INDIAN CENTRE-PIECE.

litharge, and 1 part of virgin wax. The surface must be perfectly dry before the composition is laid. It should be used hot, and laid with a brush.

Two centre flowers from India are shown in illustrations Nos. 172 and 173. An excellent example of Indian plaster work is exhibited in Plate L. This shows part of a ceiling and wall in the tomb of Jamālī at Delhi. The transition from the square or plain to the round by means of an octagonal gives a fine opportunity for ornamental plaster work. There is a great similarity in the style of this ceiling to the Moorish plaster decoration in Spain and North Africa. Shaikh Fazl-ullāh, *alīz* Jalāl Khan, but better known by his *nom-de-plume* of Jamālī, was a great traveller, a man of literary fame, and a poet. In the year A.H. 935 (A.D. 1528) he built a mosque and a room—afterwards his tomb—in the old village of Qutb Sāhib, and the ruins of the village may yet be seen in their neighbourhood. Jamālī accompanied Humāyūn to Gujrat, where he died on the 10th of Qīqā'd, in the year A.H. 942 (A.D. 1535). His body was brought to Delhi, and interred in the room which he had occupied as a dwelling during his lifetime.*

* Carr Stephen's "Archæology of Delhi."

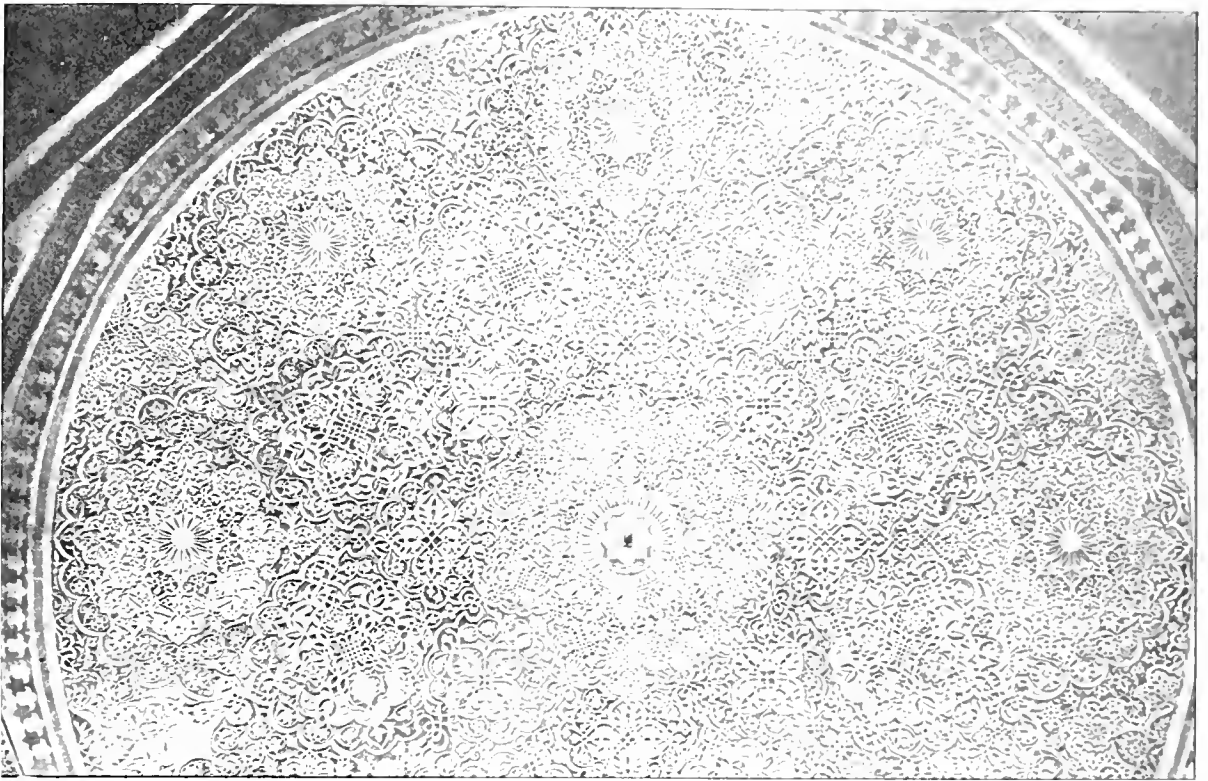

CEILING.

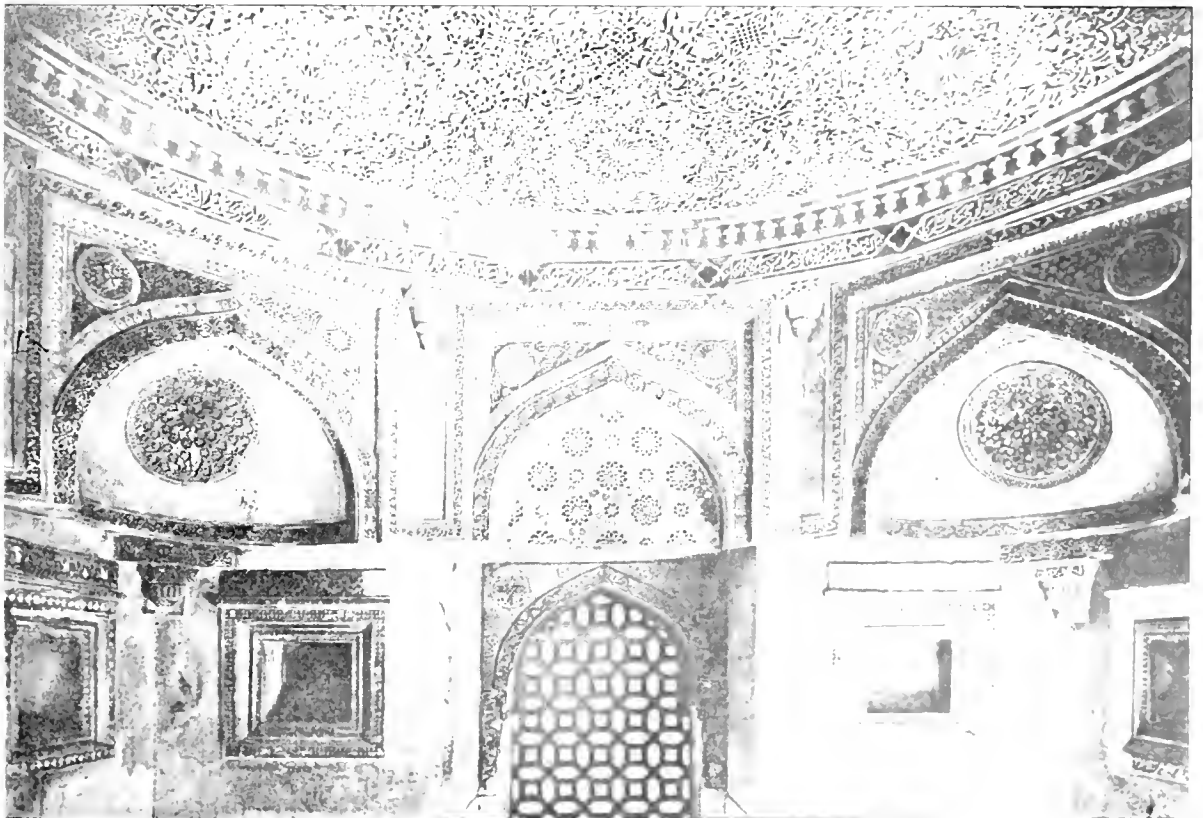

PLASTER CEILING AND WALLS IN A TOMB AT DELHI, 1528.

Mr Lundgren tells a curious story about Indian plastering. When in India after the Mutiny, making sketches in the Punjab, he and his interpreter being overtaken by a storm, sought shelter in an unfinished tomb. The ceiling had just been plastered, and was still soft. A native came in, and with three laths measured the length and width of the ceiling. He then cut the ends of the laths into different shapes, somewhat like modelling tools. After this he got on a tub, set out some lines on the ceiling, and began modelling an elaborate design on the soft plaster. Lundgren being greatly interested, stayed until the plasterer left. He then turned to his interpreter, saying that this plasterer was the cleverest man he had ever met with. The interpreter, with a look of surprise, replied, "He is an idiot." Lundgren rejoined, "I have been an artist for forty years, and I could not do such a thing straight off." The interpreter said: "His father was a clever man; he could do five patterns. He had three sons; one could do three patterns, one two, and this idiot can only do one."

CHINESE PLASTER WORK.—In China bricklayers and plasterers are united. This two-branch operative possesses the accomplishments of modeller and designer of interior and exterior enrichments, which are produced without working drawings. He creates cornucopie in circular pediments over windows; designs and models centre flowers, enriched with foliage and flowers; arranges birds and fishes on rain-pipe heads; executes panelling in parapets and works up cornices with exceeding patience by hand; rejecting straight-edges, running rules, and running moulds, and all such line and rule formalities, rather crippling his mouldings, however, in his independence. The ornamental work is all done *in situ* by hand. In order to protect these works on the exterior of a building until the plaster is set, an immense cage (*tap pong chong*) of bamboo is reared so as to enclose the whole edifice. A good thatching of leaves shelters the stucco work from the heavy rains, that would destroy in a night the work of months. A remarkable feature in the ornamentation of stuccoed fronts is the introduction of ventilating apertures near the main cornice, which communicate with flues that open into the roof when there are plastered ceilings. Other ventilators pierce the slope that connects the walls and ceilings, an inclined plane conforming to the rake of the roof, and lathed upon very slender battens, which serve for ceiling joists. Lath and plaster partitions are sometimes constructed, but boarded divisions are more common. The setting coat of internal plastering is mixed with shreds of white paper, which supplies the place of hair. The lime sets exceedingly hard. The Chinese delight to wash the plaster with a blue colour. Stone mortar *shiu fooi* is lime mixed with coarse grit. Lime mixed with red mud is used for brick-work.

ITALIAN PLASTER WORK.—Italy has always been the nursing mother of plasterers, and in Mr G. T. Robinson's "Glimpse of the History of the Art and Craft," he has shown something of her great and glorious past, and how she sent her sons over almost all Europe to raise the art and status of this craft. Even during the depressing times of her history she religiously preserved its ancient traditions and processes, and in almost all her towns there was some one or two plasterers to whom were confided the restoration, the repair, and the conservation of its frescos or its stuccos. The art dwindled, but it survived. So late as 1851 an English architect, when sketching in the Campo Santo at Pisa, found a plasterer busy in lovingly repairing portions of its old plaster work, which time and neglect had treated badly, and to whom he applied himself to learn the nature of the lime he used. So soft and free from caustic qualities was it that the painter could work on it in true fresco painting a few days or hours after it was repaired, and the modeller use it like clay. But until the very day the architect was leaving no definite information could he extract. At last, at a farewell dinner, when a bottle of wine had softened the way to the old man's heart, the plasterer exclaimed, "And now, signor, I will show you my secret!" And immediately

rising from the table, the two went off into the back streets of the town, when, taking a key from his pocket, the old man unlocked a door, and the two descended into a large vaulted basement, the remnant of an old palace. There, amongst the planks and barrows, the architect dimly saw a row of large vats or barrels. Going to one of them, the old man tapped it with his key; it gave a hollow sound until the key nearly reached the bottom. "There, signor! there is my grandfather! he is nearly done for." Proceeding to the next, he repeated the action, saying, "There, signor! there is my father! there is half of him left." The next barrel was nearly full. "That's me!" exclaimed he; and at the last barrel he chuckled at finding it more than half full: "That's for the little ones, signor!" Astonished at this barely understood explanation, the architect learned that it was the custom of the old plasterers, whose trade descended from father to son for many successive generations, to carefully preserve any fine white lime produced by burning fragments of pure statuary, and to each fill a barrel for his successors. This they turned over from time to time, and let it air-slake in the moist air of the vault, and so provide pure *old* lime for the future by which to preserve and repair the old works they venerated. After-inquiries showed that this was a common practice in many an old town, and thus the value of old air-slaked lime, such as had been written about eighteen hundred years before, was preserved as a secret of the trade in Italy, whilst the rest of Europe was advocating the exclusive use of newly burnt and hot slaked lime. Was there in the early part, indeed even in the middle, of the present century, any plaster image seller who was not an Italian? Indeed, at this present time, almost all the "formatori" or piece moulders for the majority of the sculptors of Europe are of Italian nationality or descent, and chiefly by these has the national craft been maintained.

When after the long European wars of the eighteenth and the commencement of the nineteenth century Italy had rest and power to "make itself" (*faro de se*), the first revival of its industry was felt by her plasterers, and as there were then, as now, more workmen than work, they emigrated to the neighbouring countries; and the major part of the plasterers along the Riviera, in the southern provinces of Germany and Austria, are Italians, who go off with and return with the swallows, to earn that wage the poverty of their own country cannot afford them.

No sooner had the new kingdom of Italy founded itself than the attempts to revive the old triumph of plaster work began. Sgraffitto was revived in Florence and Rome, and in 1890 the endeavour was made to re-create the grand old modelling of the gorgeous ceilings which had once been the pride of Venice, and the Papadopoli Palace succeeded in almost reviving the work of Vittoria, which has already been referred to. The Baron Guggenheim, an antiquary and a dealer in many good things, old and new, set himself to work, and here is his description of the process which he kindly communicated to Mr Robinson, who has placed it at my service. "The materials," says he, "were stone lime slaked for three or more years, and 'marmarino,' that is to say, marble dust from Carrara, pounded very fine into an impalpable powder, and most carefully selected and dried in an oven, with which to cover up the lime, which was then left for another year to gradually mix itself with the marble. It was then tempered into a paste until it was equally plastic as the clay of a sculptor, and with this you could model with equal ease. When partially set you dust the model over with the finest marmarino, and when quite dry, brush it and wash it off." The heavy masses were cored with ordinary mortar lightened by reeds, coke, charcoal, and other light substances.

As already stated, Henry VIII. brought several plasterers to England. There is still extant the will of the head of a travelling company of Italian plasterers in England, by which he left all his tools to his fellow-artists. The Italian plasterers are adepts in the working of coloured stuccos. Several of the ancient Roman baths which have been excavated in England in the present century

were lined with a fine red impervious stucco. This material also formed the floor surface. This proves that the colours were durable, and that the stucco was of a hard nature, otherwise it would not have been used for floorings. Coloured wall plasters, in fine preservation, have also been found in several old Roman villas discovered in England.

In addition to the examples of Italian plaster work already demonstrated in the introductory chapter, several others are given here. Illustration No. 174 depicts portions of five coved ceilings (with details of pateras) for circular rooms, designed by M. Angelo, Bartolomeo Ammanati, Baldassare Peruzzi, and Algardi, and executed in the Capitol (sixteenth century), the Palazzo Mattei (1564), and the Villa Pamfili (1644), at Rome. No. 175 displays two enriched soffits of arches

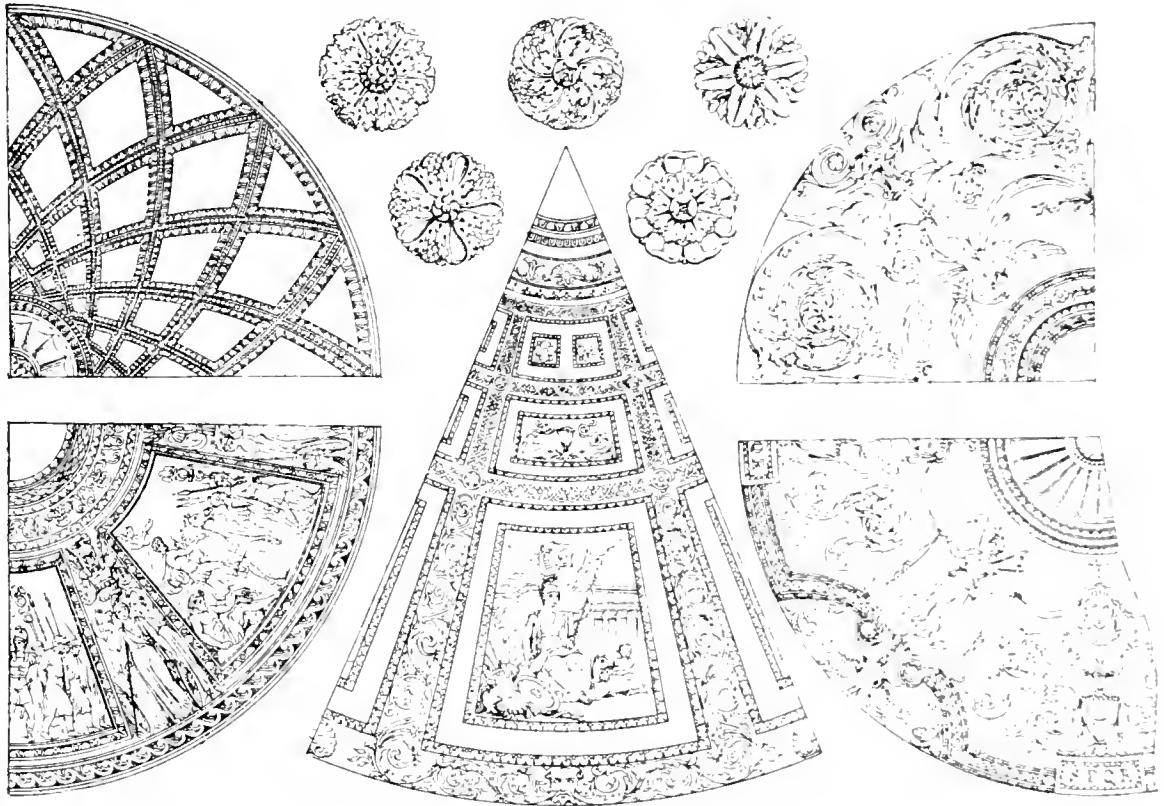

NO. 174.—COVED CEILINGS OF CIRCULAR ROOMS, FROM ITALY.

designed by Raffaele and Ammanati, and executed in St Peter's (sixteenth century) and the Palazzo Mattei, Rome.* Illustration No. 176 exhibits a stucco frieze from the Ducal Palace, Venice, designed by Giac. Albertolli in the eighteenth century.

ITALIAN STUCCO.—Stucco for decorative purposes is supposed to have been invented by Margaritoni, who died in 1317. This stucco was composed of old lime putty seasoned by age, mixed with fine marble dust, and in some cases fine sand and hair. The whole mixture was frequently turned over and well beaten with wooden beaters, a little water being added at each turning. The mixture was then laid on brick floors to absorb the moisture. Afterwards it was taken up and well beaten, until the mass was plastic, tough, and cohesive. This stucco was further

* These illustrations are taken from Sir W. Chambers's treatise, "The Decorative Part of Civil Architecture."

improved by the adding of a small portion of burnt gypsum. The gypsum was burnt in a similar manner to lime, instead of being burnt in an oven. The stucco sets in from ten to twelve hours, according to the amount of burnt gypsum used. This stucco attained great hardness, and was usually called *stucco duro*, or hard stucco. It was the principal stucco used before the introduction of lead or wooden moulds, and was usually modelled *in situ* by hand. A different mode of working was introduced by Vittoria (a pupil of Giacomo Tatti), who pressed the plastic stucco *in situ* with lead or wooden stamp moulds. The general outline was defined by the mould, the details being worked up by hand. When the design was large or repeated, the stucco was pressed into the moulds, and the details worked up by hand after the main parts were fixed.

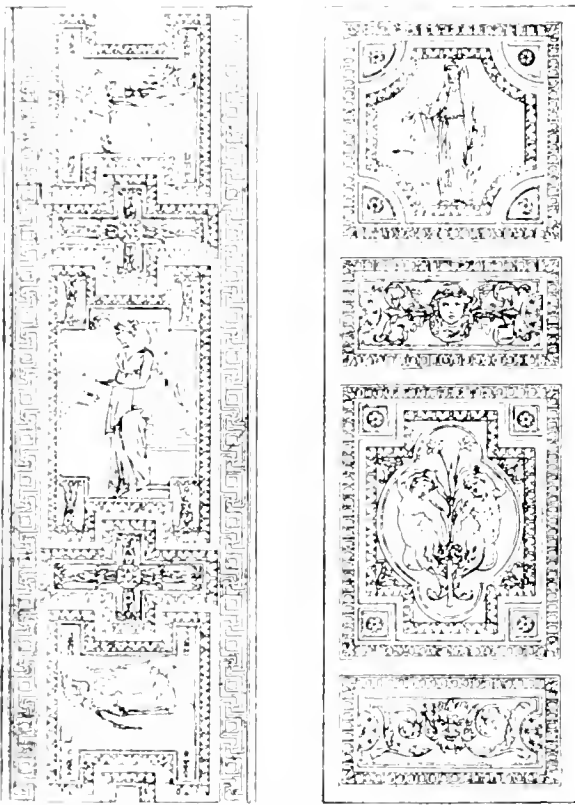

NO. 175. ENRICHED SOFFITS OF ARCHES, FROM ST PETER'S AND THE PALAZZO MAFEI, ROME.

Stucco for plain plastering is generally done in three coats. The methods are somewhat similar to our own, but the materials vary slightly. The first coat is done with ordinary coarse stuff, and the floating coat with stuff containing a larger proportion of lime. The finishing coat is made of rich lime, and after being slaked the putty lime is allowed to stand for three or four months before it is used. It is then frequently beaten up and mixed with ground Carrara marble, and for internal work with gypsum. The ground marble and putty lime, made into a stiff paste in equal quantities, is well beaten till the whole is perfectly homogeneous. This is then laid on about $\frac{1}{2}$ inch thick, and then scoured and trowelled to a smooth surface.

FRENCH PLASTER WORK.—The plastic decoration in the salons of France is largely composed of papier-mâché, such as the decorations in the Hall of the Council of Henri II., the Louvre, in the rooms at St Germain, and the Hotel des Fermes, &c. Carton-pierre has also been extensively used for the same purpose. The most notable examples were to be seen in the Tuileries, and also at the

Palais Royal, and portions of the Louvre. Modelled plaster or stucco was first used about the beginning of the sixteenth century. Good examples are to be seen at the Gros Horologe at Rouen, executed about 1530, and the Manoir of Yville-sur-Seine. Stucco chimney-pieces and wall decorations of considerable merit are to be found in many parts of France, especially in the vicinity of Toulouse. There are fine examples of decorative plaster work in the Louvre, executed by Van Ostell and M. Arnoldin. Plaster of Paris has been the prevailing material for both plain and enriched façades for ages. Victor Hugo, in the "Hunchback of Notre Dame," punningly remarks in the description of Paris, that "our fathers had a Paris of stone; our children will have a Paris of plaster." Typical examples of French plaster work are shown on Plates XX. and XXI.

French architects sometimes use plaster work in situations where the presence of plaster

work would not be suspected. For instance, in the *Bibliothèque Nationale*, Paris, the coffers and other ornamental work which spring from the piers in the hall are plaster work of good quality, but from its great height, and the absence of plaster work in other parts of the hall, would not be suspected. Again, in the Church of the Holy Trinity, the richly decorated interior of which is

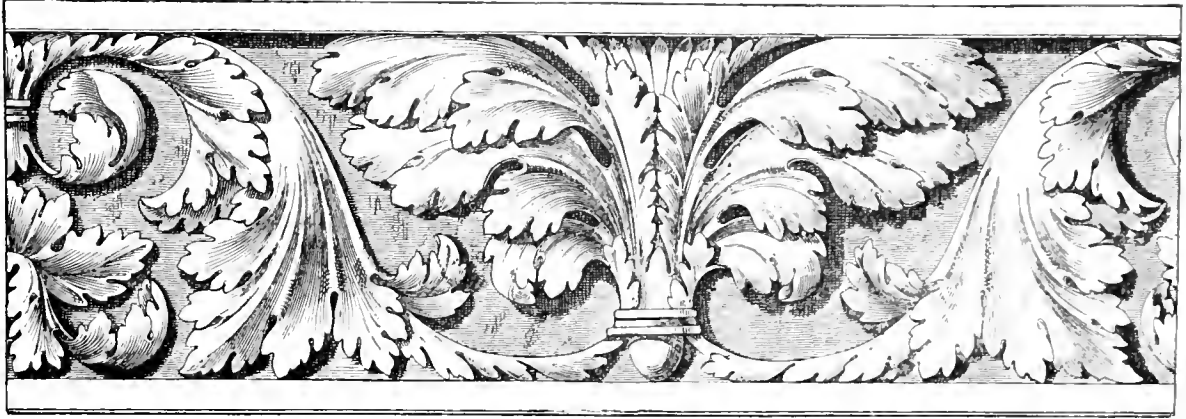

No. 176.—STUCCO FRIEZE FROM THE DUCAL PALACE, VENICE, BY GIAC. ALBERTOLLI, EIGHTEENTH CENTURY.

in stone, with the exception of some massive pillars separating the galleries from the body of the church. These alone are of plaster work, and among the best plaster work in Paris; and these columns harmonise completely with the colour of the stone work, so that even when close to them one would not take them for other than stone work. The ceilings in many of the secular

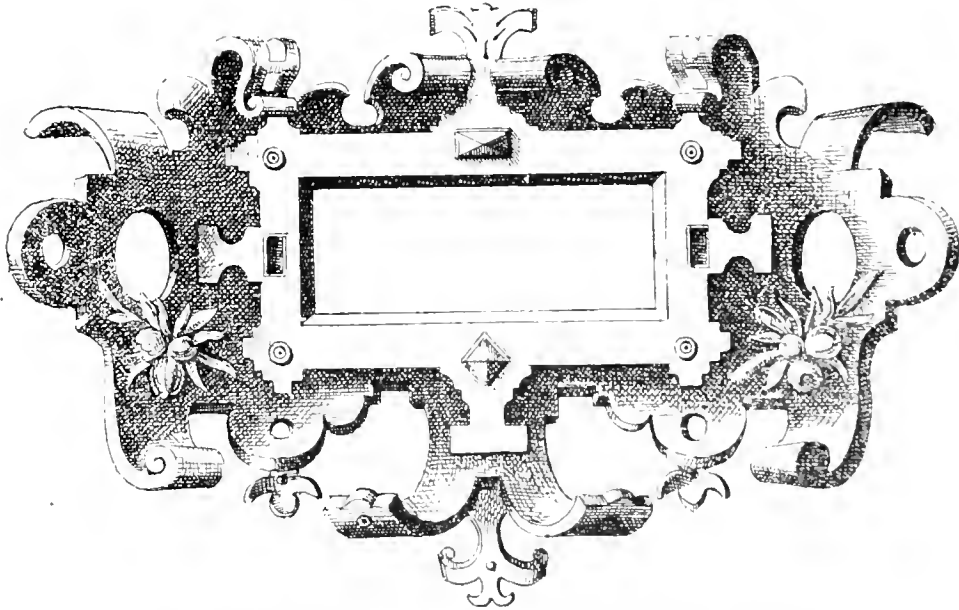

No. 177.—CARTOUCHE, FROM THE BIBLIOTHEQUE NATIONALE, PARIS.

buildings are seldom enriched with plaster mouldings, but they are imitated in oil paint or in water colours. The annexed sketches exemplify a Renaissance style of Flemish origin sometimes seen in France. No. 177 is a cartouche from the *Bibliothèque Nationale*, and No. 178 is a cartouche from Lyons.

With regard to plastering generally, there are two methods employed in France. The first is somewhat similar to our method of forming concrete floors and walls. A centring of wood is formed in a line with the proposed ceiling, and then the gauged plaster is poured on from above. Partitions are formed in a similar way. The second method, as executed in Paris by Frenchmen, seems to be far behind our own, though they turn out fairly good work, but with a waste of material that would soon make an English employer bankrupt. For example, for a plain ceiling about 10 feet by 12

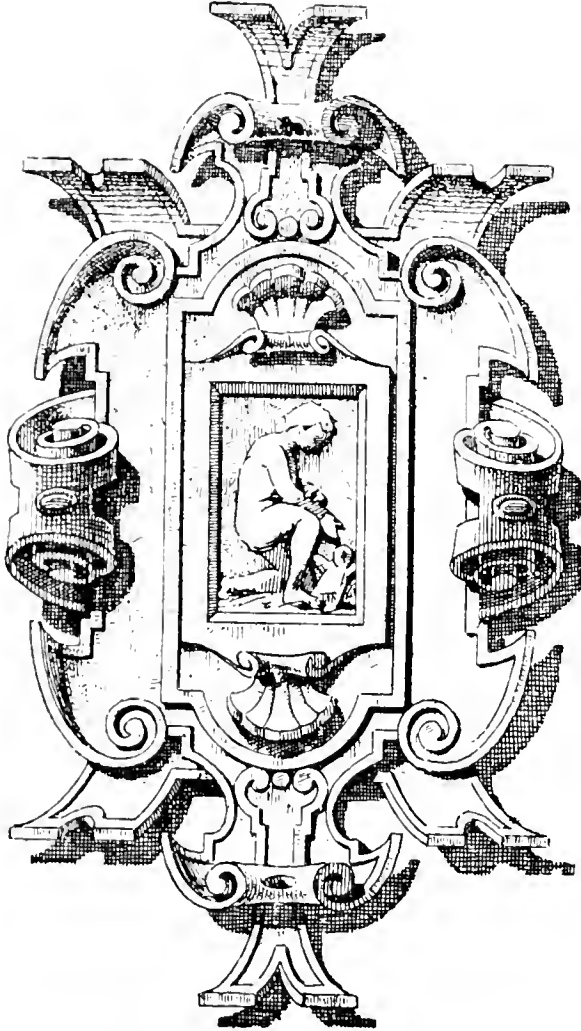

NO. 178.—CARIOUCHE, FROM LYONS, FRANCE.

feet, four men are employed, two plasterers and two labourers (or companions, as they are called). The plaster is turned out in a loose heap on the floor, and the labourers, who are supplied with boxes which contain about 2 bushels, half fill two of them with water, and add sufficient plaster to make it of a proper consistency. The boxes are then placed on the scaffold, and the plasterers begin to mix with the left hand and a trowel in the right. This trowel is made of brass, in the shape of a very wide gauging trowel, about 5 or 6 inches in width and tapering to 4 inches, with a length of 7 or 8 inches. The point being cut off straight, it is adapted to fit the corners of the box, and leave it clean as soon as the plaster begins to set. When the plaster is gauged, they splash it on the part they mean to cover. By the time this is done the plaster begins to thicken as it begins to set, and then they take it out with the trowel on to a hawk of a peculiar construction. It has a handle about 9 inches long, the board is about 18 inches and 11 inches wide, and the longest edges are formed of two strips of hardwood flush with the board. Having placed sufficient stuff on this to conveniently manipulate, they press the stuff on it against the part to be plastered, and spread it about with the flat face of the hawk, using the hard edges backward and forward to bring the work to an even surface. Two men to each box empty it, and by this time the companions supply them with a fresh pair of boxes, and so on until they have covered the whole flush with a narrow screed, formed by filling to a straight-edge bearing on dots of the required thickness. They then start to straighten the whole surface by scraping off all the bumps which are inevitable by their method of application. For this purpose they use a toothed drag. This is constructed of a steel blade about 8 inches long, toothed on one edge, while the reverse edge is straight, with an iron bow fastened to each end of the blade and a handle attached to the apex of the bow. With this they scrape down the inequalities, using the toothed edge till

feet, four men are employed, two plasterers and two labourers (or companions, as they are called). The plaster is turned out in a loose heap on the floor, and the labourers, who are supplied with boxes which contain about 2 bushels, half fill two of them with water, and add sufficient plaster to make it of a proper consistency. The boxes are then placed on the scaffold, and the plasterers begin to mix with the left hand and a trowel in the right. This trowel is made of brass, in the shape of a very wide gauging trowel, about 5 or 6 inches in width and tapering to 4 inches, with a length of 7 or 8 inches. The point being cut off straight, it is adapted to fit the corners of the box, and leave it clean as soon as the plaster begins to set. When the plaster is gauged, they splash it on the part they mean to cover. By the time this is done the plaster begins to thicken as it begins to set, and then they take it out with the trowel on to a hawk of a peculiar construction. It has a handle about 9 inches long, the board is about 18 inches and 11 inches wide, and the longest edges are formed of two strips of hardwood flush with the board. Having placed sufficient stuff on this to conveniently manipulate, they press the stuff on it against the part to be plastered, and spread it about with the flat face of the hawk, using the hard edges backward and forward to bring the work to an even surface. Two men to each box empty it, and

they get a fair surface, by which time the scaffold is covered deep with plaster, in which they tread about till the companions shovel it down off the scaffold. They then use the reverse end of the drag, and so scrape the surface to a smooth face.

It will be readily understood by any one having even an elementary knowledge of the methods adopted by English plasterers that two men could do the work of these four with more certainty of being correct, and in less time, without the waste incurred by the French system. In the English system there is art scientifically applied; theirs may be art, but without science. Their method of forming mouldings is as ours, with running mould and running rules, only they use all plaster; but for the mitres they have no notion of our system of working and taking off the stuff while in a plastic state with the joint rule. They, on the contrary, fill the mitre with gauged plaster, and with a series of tools of a plane-like form shave the stiff stuff off till they form the mouldings to a mitre, just as a mason would do with soft stone. Many of the men who do plastering in Paris are masons, or have been closely allied to them in their training. So much is this the case that they form one body for all general purposes, and at the Bourse du Travail they are recognised as one trade. This may in some measure account for the apparent similarity in their methods of doing work. The material also admits of this mode of treatment. It is plaster of Paris always, and nothing but plaster, except in rare instances, and plaster of a wholly different consistency to ours, for when gauged their ordinary plaster is of a loose granular quality, and has a somewhat soapy character in working, which makes it easy to cut and drag.

So far is plaster brought into use, that not only are the interiors done with it, but also large and imposing fronts with cornices, architraves, pediments, pilasters, columns, and all the other adornments that go to make classic architecture, or the expression of the architect's ideal in any style or combination. This will seem strange to many English plasterers—for, according to our insular notions, plaster will not stand exposure—yet in Paris all the houses that are built of rubble stone are faced in plaster, and it stands good for many years. The material is so cheap that if it does fail in any part it can be easily and cheaply renewed.

It is a common occurrence to see the fronts of large and handsome houses replastered outside, and though the fronts are only a little smoke-begrimed, yet they are stripped of the entire plastering, and done afresh in the semblance of a nice soft white stone. No paint being applied annually or bi-annually to these fronts, so much as it would cost could be saved to replaster them, and thus have a new front for another series of years. Lime and sand with hair, as we use them, are unknown, or nearly so; but where it might be expected that the strain of the expanding plaster would lead to cracks, as over bracketing in cornices or the like, they use a large quantity of tow in core, which they lay about and mix in with the plaster while in a plastic condition.

Plaster is the general material for interior and external work. Carton-pierre, papier-mâché (as previously stated), and fibrous plaster termed *staff* are extensively used for decorative purposes. Portland cement is rarely used except for concrete work. Parisian plasterers are a courteous, sober, and generally thrifty body of men. In working attire their everyday clothes are well protected by a large clean blouse, which looks better and seems more adapted for the purpose than the scanty jacket and short apron often only the latter as worn by most of the London plasterers. Their wages vary from 8d. to 8½d. per hour. They work ten hours in summer, and eight to nine hours in winter—Sunday included. But few of them work more than six days in any one week; if they do, they generally take a holiday the next week. They have little or no piece-work, and they are paid monthly on the first Sunday in the month. They have no rushing or driving, as is often the case in London. No one seems in a hurry, yet none seem to be idling.

The trade is generally regular throughout the year in Paris. There is an interesting description of Parisian plasterers in the "Artisans' Report to the Mansion House Committee on Plastering at the Paris Exhibition, 1889," by Mr T. Smythe, plasterer, London.

CARVED PLASTER WORK.—In and around Paris, many of the large mansions have their entrances, halls, and principal staircases decorated with carved plaster. The work is done *in situ*, and the material is prepared and manipulated in a peculiar way. It is composed of coarse plaster and finely ground lime, and is worked up exactly in the same manner as that employed by the Persian plasterers (described on page 426). It is then laid on the walls and ceiling, and made level with the trowel. When partially dry it is wrought to a fair surface with drags, and then the ornamental parts are carved like soft stone. When perfectly dry it is rubbed down with a fine sandstone, and is then as like stonework as possible. This work becomes exceedingly hard, and is very durable.

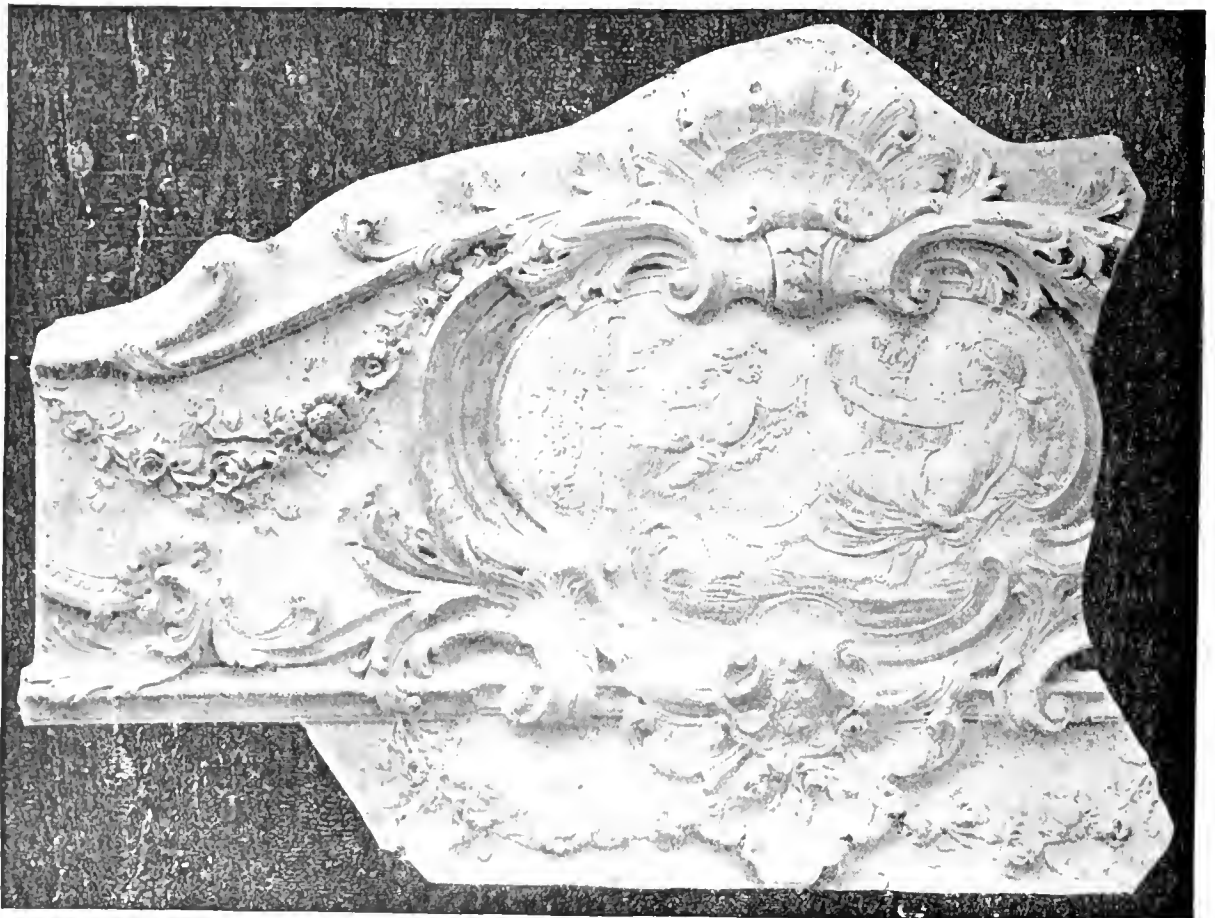

NO. 179.—PORTION OF PLASTER CEILING (MODERN GERMAN), DESIGNED AND MODELLED BY R. SCHIRMER, BERLIN.

GERMAN PLASTER WORK.—German plasterers make excellent work. Their method more nearly approaches to the English than that of other Continental workmen. They have good designers and modellers. The Government authorities take a great interest as to the best kinds of materials and methods of working. They also give great encouragement to fireproof construction.

It is a noteworthy fact that floors protected with plaster work have given the best results. Neat plaster is used for slab work, also ordinary plastering on a network of wood rods and iron, or iron alone. This is quite feasible, bearing in mind that the conductivity of common plastering, compared with firebrick or building brick, is as 26 to 66, and that an ordinary plaster ceiling on metal lathing, with the iron well embedded, will resist an intense heat for a considerable time.

Plastering in Germany is usually done on reeds instead of wood laths. Plaster slabs have lately been introduced, and are used to a considerable extent for internal plastering. The Germans manufacture fine Portland cement. About two decades ago a number of London plasterers were sent to Berlin to construct concrete houses and plaster house fronts with Portland cement. Since then the German plasterers have been fairly proficient in the manipulation of Portland cement.

It has already been mentioned that the German Government offered valuable prizes for the best method of indurating plaster casts so that they would resist the weather, also for the best kind

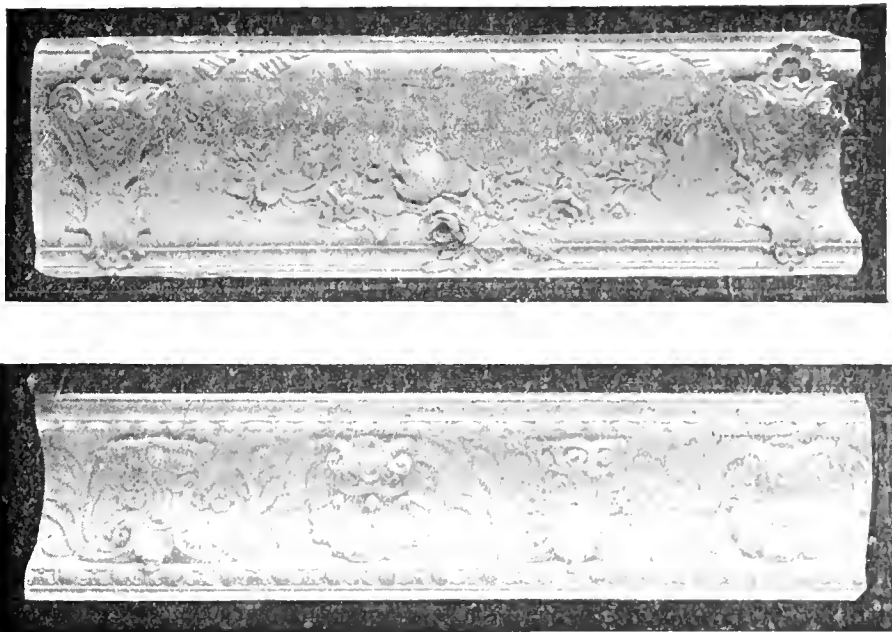

NO. 180.—PLASTER CORNICES (MODERN), BY R. SCHIRMER, BERLIN.

of materials and method of using same for exterior plastering. The methods are described hereafter. The annexed illustrations are good examples of modern German plaster work. Plate LI. shows a centre flower, partly oval in outline, with a bold design and effective modelling. Illustrations Nos. 179 and 180 show portions of a plaster ceiling and two cornices, and No. 181 a wall panel. These are taken by photography from the actual casts.*

GERMAN MORTAR.—Some years ago the "Verein zur Beforderung des Gewerbefleiss in Preussen" (Society for the Promotion of Prussian Industry) offered a prize for the best composition of plaster for brick walls. The conditions imposed at the time were—(1) That the composition should not be affected by the weather, and present an even smooth surface when applied, becoming neither cracked nor loose by exposure to sun or frost; (2) That the composition should admit of a

* They are reproduced from a series of excellent plates, published under the title of "Plastische Ornamente," designed by Robert Schirmer, and published by Hessling & Spielmeier, of Berlin: London Agent, B. T. Batsford.

uniform durable colour being applied to it, the colour to penetrate either through the whole mass or at least to a depth of one-tenth of an inch from the surface; (3) It was further stipulated that although the application of this composition might somewhat exceed the cost of ordinary painted plaster, still its use should be cheaper than "stucco lustro." The silver medal of the Society, supplemented by a money prize of £75, was awarded to Ambroselli, a mason of New Barmin (near Wurzen), after his plaster composition had been proffered to the Society, and stood a practical test of several years' exposure to the weather. Before proceeding with the description of its application, it may, however, be well to remark that no new principles or materials are advocated in the composition; but on the other hand its application demands great exactness of workmanship and a careful selection of the ingredients. Moreover, the laying-on process demands that the wall surface on which it is to be applied be built of hard, well-burnt bricks, free of marl, and previously thoroughly dried. The materials used are lime and sand, which must be entirely freed



NO. 181. PLASTER WALL PANEL (MODERN), BY R. SCHIRMER, BERLIN.

from all impurities by special cleansing, and as the following description will show, three different kinds are prepared from three qualities of sand. The inventor describes one of its most difficult applications, namely, the imitations of sandstone dressings, as follows:—The brickwork itself should be as near as possible to the desired profile, so that the laying on may be done in as uniform a manner as can be obtained. The wall surface, being previously well damped with water, is now ready to receive the first coat. This is composed of one-third of well-slaked lime (which should be slaked not less than a fortnight previous to using it), and two-thirds of the sharpest sand. After the mass has been thoroughly mixed together, Portland cement is added in the proportion of one-fourth of the volume, and the first mortar composition, after having thus been prepared and well mixed, is applied in a wet state to the surface of the wall as evenly as possible. To prevent air-bubbles or cracks occurring, the different layers should not be applied too rapidly, and time should be always allowed between the layings on, in order that the mortar may set. The

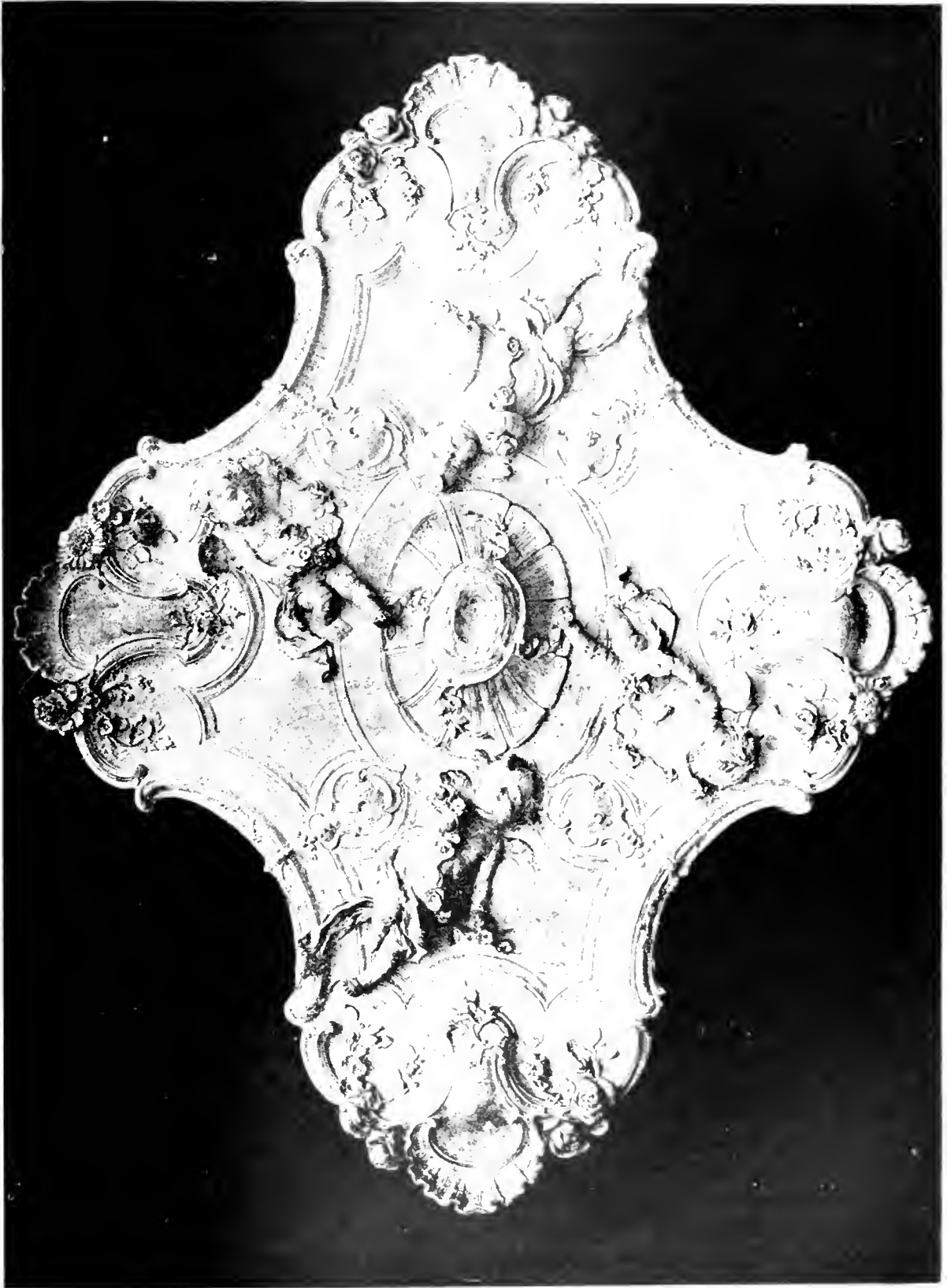

desired profile having been nearly attained with mortar No. 1, a finer mass (No. 2) may now be laid on. The latter is prepared by adding to 2 parts of lime and 2 parts of fine sand 0.12 parts of Portland cement, and so much of the requisite colouring liquid as is necessary to produce the desired tint when stirred together with mass No. 2. Two layings on with this second mortar

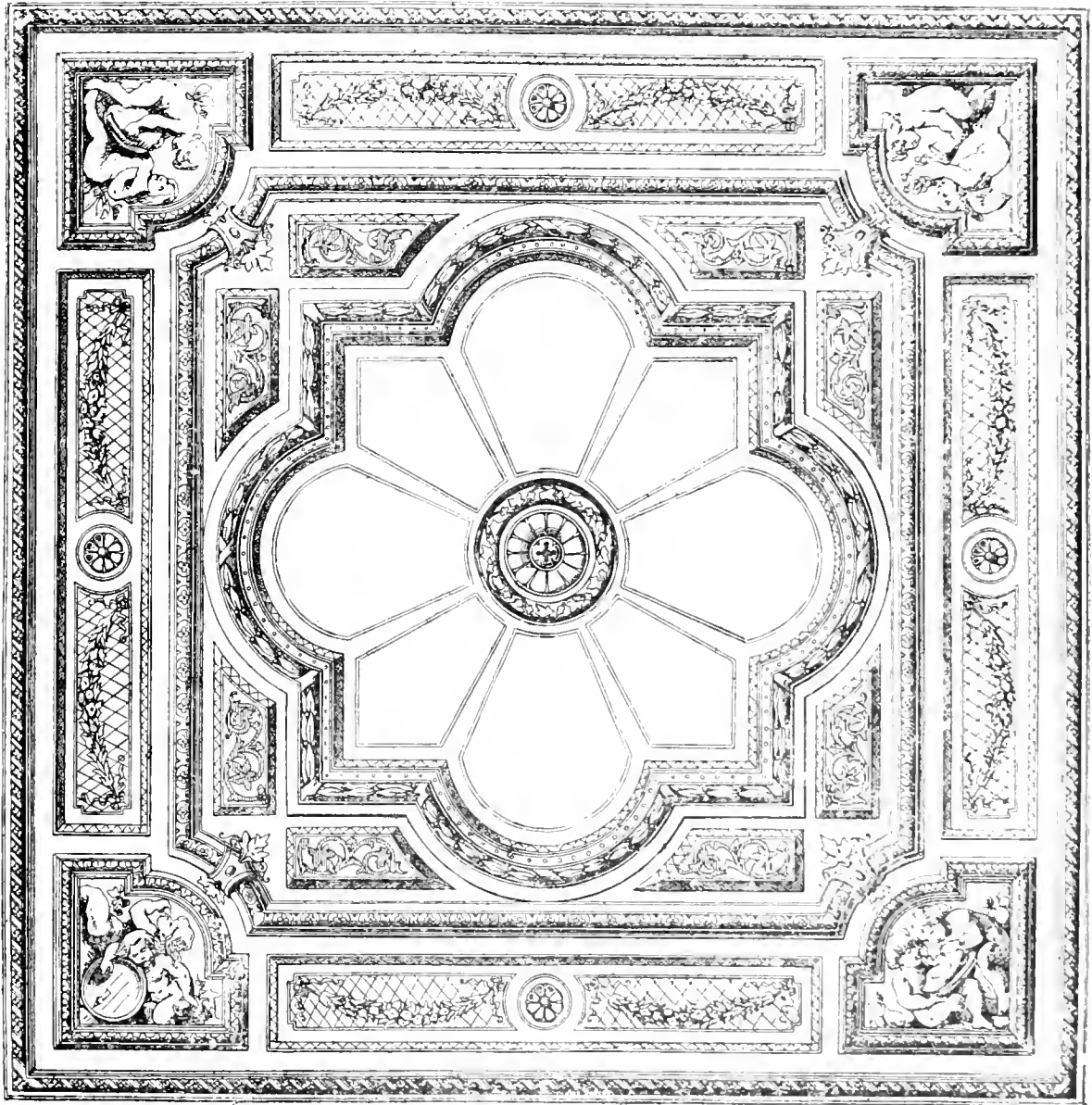

No. 182.—PLASTER CEILING OF A RESTAURANT, VIENNA.

will suffice in ordinary work to bring the desired profile to the required form. For very fine work, however, a third coating is used, which is made of 1 part of the finest sand, 1 part of fine-sieved lime, 0.5 parts of fine-sieved Portland cement, with the addition of the requisite colouring matter to ensure the desired tint when dry. This addendum must of course be

determined by experiments made beforehand, which will give the necessary proportion required. The most complete intermixing of these ingredients is absolutely necessary. It is advisable to divide the laying-on surfaces into so many days' work, since each portion begun must be finished the same day, for the reason that the composition cannot be touched up after a certain lapse of time.

The above description of plaster work is interesting and useful, as showing the great necessity of careful selection, mixing, and manipulation of plastic materials, even of the ordinary kinds for everyday use. This goes to prove that good and enduring work for exterior purposes can be

obtained by the use of lime and sand (with proper care) and the addition of a small percentage of Portland cement. The colouring matter being a part of the finishing coat, enables the colour to wear more uniformly and be more durable than if the surface was painted. The method of mixing colour with the finishing coat has for a long time been common in many parts of England, as is also the mixing of Portland cement with lime mortar.

AUSTRIAN PLASTER WORK.—The Austrian plasterers execute very good work. In Vienna the

house façades are generally faced and enriched in stucco, and the use of stucco is a handicraft the workers in which carry on their trade and hand down their traditions from father to son. The stucco is composed of white lime, and kept in water for a considerable time before using. Danube sand of varying degrees of fineness is mixed with the matured lime, coarse grit being used for the floating (which is brought

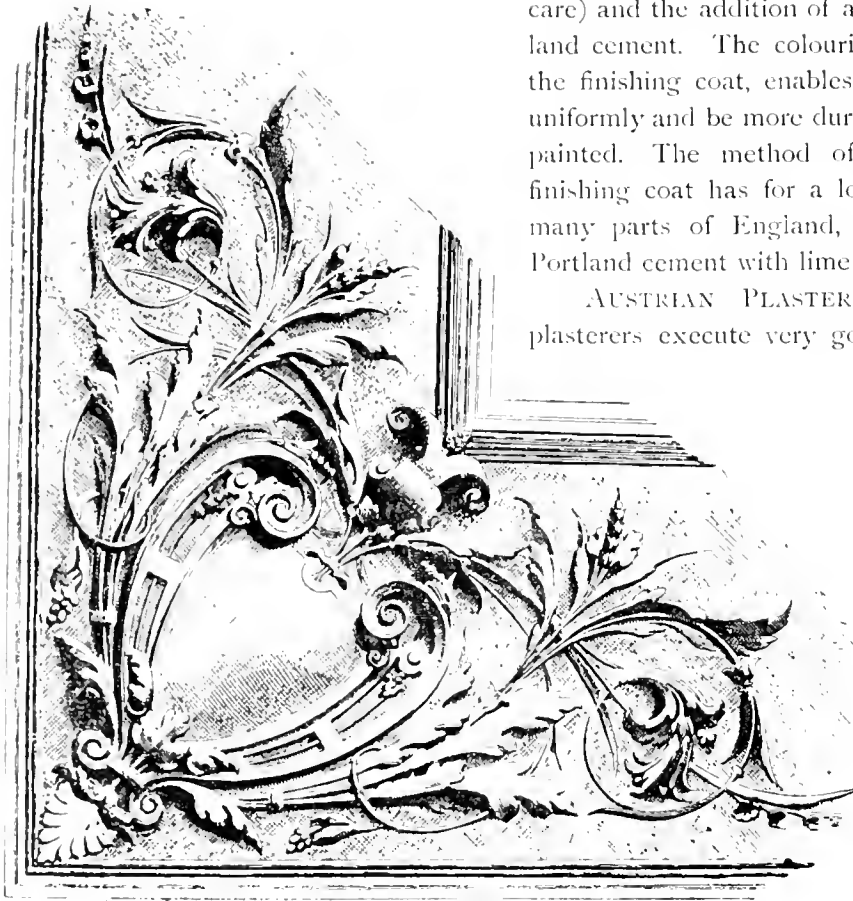

NO. 183.—PLASTER ANGLE PIECE, VIENNA.

out in one coat and the finest for the fining. The proportions of lime and sand are regulated according to the class of work in hand and the state of the brick walls. The materials are not measured but simply mixed by guess-work, the workman judging of its fitness by the appearance as it runs off his fingers after dipping. Portland cement and hydraulic lime have been tried, but the plasterers seem unable to make such satisfactory work in these materials as in those of their grandfathers. Figure work is largely employed, it being used in every situation in which the human figure can be placed on the external elevation of a building. These stucco and cement façades stand well, and are coloured with distemper (made and used by plasterers) as soon

as they become discoloured by age. This method might be employed for most of our old stucco fronts at home. They would look brighter and cleaner. Women, mostly barefooted, are employed as plasterers' labourers in Vienna.

The Government encourage the advancement of art and science. The Museum of Applied Art, with its Technical Art School, built in 1870, has special modelling and plaster-casting rooms. The façade is enriched with sgraffitto and majolica medallions, showing heads of celebrated artists and art workmen. Vienna plasterers are also excellent workers in scagliola.

In 1886 the Alpine Steel Company, near Vienna, purchased the Austrian rights of one of my artificial stone patents, and I sent several London plasterers to Austria to instruct their workmen in the patent process for working Portland cement and slag. The annexed illustrations are examples of modern Austrian plaster work. No. 182 shows the plan of a ceiling of a restaurant, Vienna, designed by F. Schventhaler; No. 183 shows an angle piece in a private mansion; and No. 184 shows a part of an exterior column.

BELGIAN PLASTER WORK.—Belgian plaster work is somewhat similar to the French. They use carton-pierre and fibrous plaster for many of their decorative works. Portland cement is largely used for artificial stone and paving work. A mixture of lime, ashes, and sand, termed "Cendree de Tournay," is used as a hydraulic mortar. Belgian modellers are excellent designers, and produce some fine work. Illustrations Nos. 185 and 186 show pilaster panels from Brussels. During the last two decades there have been several invasions of Belgian plasterers to London. They were employed on the decorative plaster work at Terry's, the Court, the Garrick, and other London theatres. They were also employed at the Tivoli, in the Strand, where they executed the fibrous plaster work of the auditorium, dining-rooms, and bar ceilings. The principal dining-room is called the Palm Room, and palm leaves are predominant in the fibrous plaster ceiling, which is of a pendentive character. The auditorium ceiling is of an Indian character. The modelling is creditable, but the fibrous work is indifferently made and fixed. The joints are coarse, and showed signs of opening before the work was painted. Some of the main mouldings are run *in situ* in the solid. The method and finish of this part of the work would not be passed by the most tolerant clerk of works, the mouldings being of a weak nature and more or less wavy. The amount of material wasted was nearly equal to the amount used. A curious feature in their tools was a substitute for the hawk.

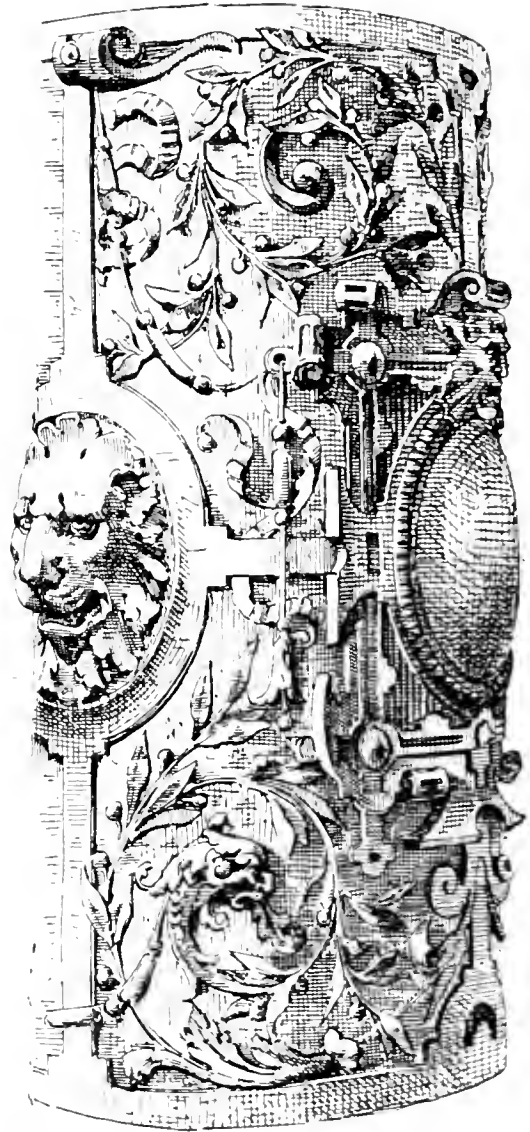

NO. 184.—PORTION OF AN EXTERNAL COLUMN, VIENNA.



NO. 155.—PLASTER PANEL FROM BRUSSELS.

This tool took the form of a diminutive hod, having a short shank with a spur-shaped end, which fitted and rested on the plasterer's leg just above the knee. When this hod was charged, the stuff was pushed out with a trowel on to the part to be plastered. This system is slow and laborious, and not so workmanlike as using a hawk.

It is a remarkable fact, in connection with this foreign competition, that an evening newspaper containing a description of the Tivoli, after giving a glowing account of the building, stated that the fibrous plaster work was given to a Brussels firm, as English plasterers could not do that kind of work. It is needless to say that this is directly opposed to facts, and is not only a libel on British employers and employees, but an insult to British intellect. The only thing in which the British could not compete was the price. But when one thinks of the miserable way that the Belgian workmen herded together, and the scant, coarse, and cheap food that they existed on while here, there is little honour or fair competition in the undertaking. It is worthy of note that no technical papers, in their descriptions of the building, gave such statements. It may be owing to the confined circulation of the evening paper that the unjust remarks escaped notice by trade journals. In flat contradiction to the statement as to the ability of English workmen I may adduce the following fact. When the building was nearly finished, another architect was appointed to complete the work, and he had a small portion of the fibrous plaster work done by Messrs G. Jackson & Sons. This work is the ceiling of the entrance hall leading to the grand staircase. And although it is only a small ceiling, yet the work is artistic, sharp, and of sound workmanship,



NO. 156.—PLASTER PANEL FROM BRUSSELS.

will bear close inspection, and compare favourably with the Belgian work. This fact is supplemented by numerous and excellent works in fibrous plaster which are to be seen in many of the principal mansions and public buildings throughout Great Britain and Ireland. These works were executed by British workmen long before the invasion of Belgian plasterers. These facts should be borne in mind by those who frequently declaim about foreign competition and the inaptitude of their own countrymen. Nor should it be forgotten that at the Paris Exhibition of 1889, where there were such an assemblage of buildings in most modes and styles of architecture in every land under the sun, in which the skeletons were mainly constructed with iron or wood and clothed with plaster work executed by plasterers from many climes, few of the plaster works could compare with, and none excel, that done by British plasterers.

RUSSIAN PLASTER WORK.—The use of plaster work in Russia is somewhat limited, as in the country and the smaller towns wooden buildings are still in a large majority. The introduction of decorative plaster work is said to be due to Vladimir, who built Vladimir and other towns, and invited artists and craftsmen from Greece and Italy in the eleventh century. Kiev, once the capital of Russia, had its principal edifices decorated with plaster work. Ivan III. imported many foreign artists for the embellishment of Moscow, which was the capital, 1490. Peter the Great engaged artists and artificers from all the art centres in Europe to decorate buildings in St Petersburg, the new capital, founded in 1703, and the most important works in plaster have been done by or under the supervision of foreign artists. There are numerous lineworks on the banks of the Ishora and in the Peterhof district. There are also several Portland cement factories in various parts of the country, and the output is increasing yearly. A similar industry is the manufacture of plaster from gypsum. There are several large factories in St Petersburg, where it is burnt out of the natural gypseous stone. The manufacturers of plaster cast and paint plaster figures and ornaments themselves. The latter they generally do very artistically. The greater quantity of the plaster produced is used for stucco work in buildings. Plaster work, like most of the Russian building trades, is in its infancy, and, like everything else of immature age, it is liable to weaknesses and errors. It will not be long before the Russian systems will be altogether revolutionised, and then when Government and people walk hand in hand, with no ulterior object in view than the practical good of the country, all those industries which are founded upon its natural resources will rise and flourish.

CHAPTER XVII.

TERRA-COTTA.

TERRA-COTTA WORK—MODELLING—MODEL MAKING—MOULDING—PRESSING—DRYING—FIRING—FIXING.

TERRA-COTTA.—The literal meaning of the words "terra-cotta" is clay baked, the material being clay previously modelled or moulded and pressed into form, and then burnt in a kiln. The date of the first use of terra-cotta is lost in remote antiquity. Antique specimens have been discovered that after three thousand years are nearly as perfect as when first made. This proves the durability of terra-cotta, and also that the old specimens in the form of vases, statuettes, panels, and other varieties of modelled and architectural decorative work, stand the ravages of time better than stone, marble, or bronze. The marbles and bronzes found with the terra-cotta were crumbled and cankered. Pliny mentions a dish or vase made for the Emperor Vitellius that cost a million of sesterces, which in our money would be over £4,000. He also states that it was the custom to make figures of the gods in clay, and that many such figures remained in his time. The remains of Pompeii and Herculaneum contain some fine specimens of modelling in the ends of the baked clay roof-tiles, vases, statuettes, and other works of art.

This material was greatly used for vases, and by the aid of Greek art, which has transformed the commonest of materials, clay, into a durable substance having rare form and beauty, some of these vases are so valuable that in recent times they have been sold for more than their weight in gold. The greater number of them have probably been turned or thrown on a potter's wheel. The potter's wheel is mentioned in Scripture, and is said to have been invented in China, and to have passed into Egypt, Greece, and Arabia. The potter's wheel now in use is nearly the same as that carved on the tombs in Egypt. Some of the old vases have evidently been moulded, and the ornamental work drawn while the clay vase was yet damp.

Terra-cotta ware, such as vases, plaques, &c., is first "thrown" on the potter's wheel, which gives the general form required. After being dried, it is turned on a lathe to the design required, the decorative lines, "runners," or coloured lines being run round it while in the lathe. The coloured pigments are not water or oil colours, which would perish in the fire, but minerals. Artistic designs are also painted or transferred on the vases, &c., before they are submitted to the kiln.

Sarcophagi of terra-cotta, ornamented with bas-reliefs and with recumbent figures of the deceased, are to be seen in the British Museum. Pliny states that Varro and others directed that their bodies when dead should be deposited in baked clay or earthenware. Terra-cotta vases, richly decorated with scenes from real life, were used on the Dipylon tombs at Attica, B.C. 700. Finely decorated vases were used in Etruria, B.C. 500. Homer states that the dead were cremated, and that the tombs were huge mounds and vases. The vases were decorated with scenes from epic mythology—Perseus and Medusa, Herakles and Nessos, &c. Cicero says that Demetrios, B.C. 310, abolished the use of groups of figures on tomb vases. Mr Flinders Petrie found many terra-cotta

vases and statuettes in trenches at Naucratis. Mr Gardiner has deciphered the name of Rhœcus on one of the statuettes. Rhœcus was probably the same sculptor who was in antiquity spoken of as having worked in the Egyptian style, and who was at the same time, with his son Theodorus, one of the originators of the production in Greece of statues of divinities. On a vase was found the name of Sappho, whose brother, if not herself, journeyed to Naucratis.

The Chinese, Persians, Babylonians, and Indians were great workers in terra-cotta, and even in Central and other parts of America specimens have been dug up. In Italy, some of the principal towns have buildings (erected between and during the twelfth and sixteenth centuries, adorned with rich terra-cotta. Fine old foreign examples are to be seen in the South Kensington Museum. Bernard Palissy brought terra-cotta to great perfection, and his particular make is named after him. Elers of Nuremberg came to England in the seventeenth century, and started a kiln near Burslem. He afterwards removed to Lambeth, where he founded the first kiln there. A fine collection of works of art in artistic pottery and terra-cotta, by Flaxman and Wedgwood, was founded at Burslem and Etruria over a century ago. Lambeth was the first, and is still the London home of terra-cotta.

Terra-cotta works were founded at Lambeth about a century ago by M. Conde. The principal modellers in terra-cotta at that time were Rossi, who modelled the caryatides and other adornments at St Pancras' Church, London; and Bub, who modelled the figure frieze on the façade of Her Majesty's Theatre, Haymarket, and the statuettes on the cornice, and in the tympanum of pediments in Regent's Park.

On an old house at the corner of Belvidere Road, Lambeth, there is a small oval artistic panel, marked "Conde's Row." This house was once the showroom of M. Conde. Here Conde, the great Flaxman, and John Bacon, the celebrated sculptor, worked.

Fulham Pottery, some centuries old, now exists in prosperity. From this pottery sprang Doulton's famous Lambeth Pottery Works, Mr Doulton having served an apprenticeship here. Mr G. Tinworth, by his high-class artistic modelling and designing for terra-cotta, has obtained a world-wide reputation for the Doulton firm. Messrs Stiff & Son turn out sound and artistic work. Mr Pulham, formerly a modeller, produces some fine terra-cotta works. Messrs W. Cubitt & Co. stand alone as being the only builders who also execute terra-cotta work. It was at Cubitt's that I gained a knowledge of terra-cotta. Columbia Market, erected for the Baroness Burdett Coutts, may be cited as one of the many terra-cotta works executed by Messrs Cubitt. There are many provincial firms whose work, for hardness, colour, evenness, and beauty of modelling, will compare favourably with that of any other country.

TERRA-COTTA WORK.—Terra-cotta is simply clay cleaned of all impurities, and sometimes mixed with sand, crushed glass, old pottery ware, and flints. The latter materials are ground and sifted, and then mixed with the clay in larger or smaller proportions, according to the kind of clay used and the class of work in hand. Devonshire clay is a fine material for modelling and firing, but it is not so hard and flinty as that of Staffordshire. It has been said that no country in the world can produce a clay better suited for terra-cotta than England. The addition of sand or broken pottery ware to the clay makes the harder terra-cotta, but the unmixed clay is usually employed for fine art. Mixed clay is generally ground in a pug-mill. It is then made into pieces of convenient size, and beaten or tempered until it is of an even consistency, like modeller's clay.

Terra-cotta work may be produced direct from the modeller's hands. The models may also be moulded, and then pressed or cast as desired; but in either of the three methods the work must be dried and then finally fired. Great care is necessary in the selection of the clay, and the combination

of the materials mixed with it. Especial care and experience is required for drying and finally firing, so as to ensure hardness, evenness of line, and uniformity of colour. Unevenness causes bad joints and unsightly mouldings. The terra-cotta work at the Albert Hall is a distressing example of twisted and uneven work; whilst the Natural History Museum, and many other buildings in London and the provinces, are pleasing examples of good terra-cotta work.

TERRA-COTTA MODELLING.—Terra-cotta work modelled direct from the clay, while dispensing with waste or piece moulding and pressing, also permits the work to leave the artist's hands with all its original freshness and artistic touches. When modelling in this way the artist must dispense with interior wood or iron supports, because as the clay dries round the supports it would crack in shrinking, and consequently the model would be injured. Again, if the supports were of iron, the intense heat would cause them to expand and melt, and if of wood they would be consumed, to the utter destruction of the model. A simple way is to model the work solid, and then with a wire tool or a knife to make a thin section down the back, or any other part that is usually not seen. Then make a plaster case on the section to support it, and insert a wire and cut out the section, which will then come away with the case. Lay this aside until wanted. Then cut or scoop out the interior, leaving a uniform thickness of clay in all parts of the model.

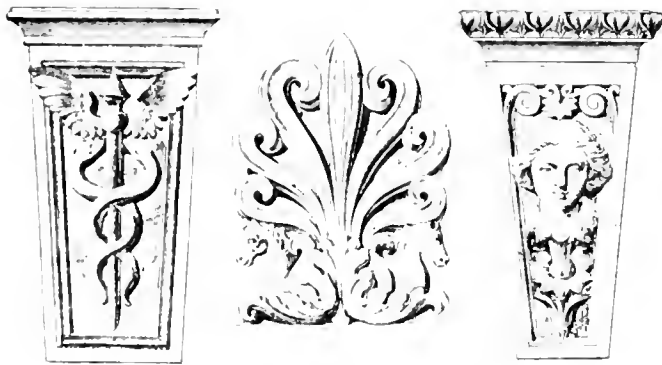

NO. 187.—KEYSTONES AND ANTEFIX.

The thickness varies from 1 inch to 2 inches, according to the size and purpose of the work. The edges of the back section are then damped and brushed over with clay water to ensure adhesion, and the piece replaced, the joint being concealed by being worked over. Models that are not open are pierced with small holes in unexposed parts to allow the steam to escape. The model is placed in a drying-room until thoroughly dry. It is now ready for the kiln. Some artists wash the whole surface of the model with a thin solution of clay, which gives a fine

bloom. It is sometimes necessary to cut off the arms, legs, drapery, or other accessories to allow the work to be made hollow, or if the model has to be piece moulded for further casts. The joints are then fixed on with well-tempered soft clay. These parts are supported in position with props until the whole model is dry and firm.

Decorated blocks for architectural purposes, or repeated work, are made and then modelled in the same way as used for plaster and concrete work. The annexed illustration (No. 187) shows design of two keystones and one antefix in terra-cotta. This antefix is enriched with sea-horses and foliage. The upper part is known as the Greek honeysuckle. Antefixæ are upright ornamental blocks placed at intervals on the cornice along the side of a roof to conceal, or rather terminate, the ridges formed by the overlapping of the roof tiles. Similar ornaments, or a statue, which are placed on the apex of a pediment, are called acroteria.

MODEL MAKING.—Model making is an important part in the formation of terra-cotta work. In the first place, the architect's design should be given to the general foreman, or a draughtsman who has a knowledge of solid geometry combined with a practical knowledge of bonding and jointing of stone work. The drawings are usually made to a $\frac{1}{2}$ -inch scale, each elevation being kept separate. A tracing of the $\frac{1}{2}$ -inch scale should be submitted for the architect's approval before the work is begun.

The dimensions for working, or full-size drawings, are taken from a "shrinkage," or "clay" rule. This rule is 26 inches long. One side is divided into 24 equal parts, each part being again divided into 8 parts, similar to an ordinary rule. The other side is divided into 24 ordinary inches, leaving an inch blank at each end. If there are no full-size drawings to work from as is often the case, for plain simple work, the models are made to the desired size by the aid of the "shrinkage rule" from the figured drawings. It will be seen that the clay "squeeze" (produced from the piece mould of the model), which measures 1 foot by the shrinkage rule, will, when burnt, measure 1 foot by the ordinary rule. This combined or shrinkage rule is often blamed for the mistakes that sometimes occur through the forgetful or over-anxious workman. To prevent these mistakes, which cause vexatious delays and loss, it is best to check the measurement of all models before they are moulded. All clays have not an equal shrinkage, and it is necessary to have a clay rule for each kind. Here again, to prevent mistakes, the measurement of the models should be checked by the setter out. Blocks of different form or size should have separate full-size or "clay drawings." Plaster is the usual material for model making.

MOULDING.—Moulding for terra-cotta work is similar to plaster piece moulding for plaster or concrete casting, dry moulds being the best adapted for speedily obtaining good sharp impressions, consequently the less plaster there is in the mould, the less moisture, and the more readily the mould dries. Reverse moulds may be advantageously used for many parts of terra-cotta. Moulds for terra-cotta require no seasoning, but are simply dried. Each mould should be numbered and initialed by the maker, as a means of identification.

PRESSING.—This is done by a workman technically termed a "presser." He should be supplied with a duplicate order form, on which there is a sketch of the block, the quantity required, the number of the mould, the name or key letter of the job, and the date. This saves waste and confusion, and affords an identification for the work and the worker. The presser cuts balls of prepared clay with a wire into sheets of the desired thickness, and smooths the surface by rolling or pressing it on a bench. He then presses it on the face of the mould, repeating this until the whole mould is covered to the necessary thickness, which should be as uniform as possible. The casts are made hollow to allow for contraction when being fired, as the heat that has penetrated the thin parts has only partially penetrated the thicker, and consequently the contraction is unequal, and the cast liable to be contorted, or fly into pieces. Care must be taken, when pressing, that all the clay pieces are thoroughly incorporated with each other. If not, blubs, creases, and patches will show. When the whole surface is equally covered, clay partitions are formed from side to side, or from end to end, or both ways, so as to form internal supports. It is then at once taken out, and if plain work, the presser may take off the seams and clean the work up, but if the work is of an ornamental nature, the seams are taken off, the whole cleaned up, and the foliage undercut by a good shop hand. If the work is of a highly artistic nature, the modeller puts on a few original touches, and strengthens the dull parts and general effect. By this means a squeeze may be made to have all the spirit, and much of the merit, of an original model.

The mould after being used a few times becomes damp, which prevents the casts from leaving cleanly and expeditiously. In such a case the mould is put aside for a time to allow it to dry, or for the purpose of preventing the adhesiveness the mould is dusted with finely sifted flint glass powder. In some instances a fine clay is used for the face surface and a coarser quality for backing up to the desired thickness. Great care is required when pressing mouldings to ensure straightness of the members, and intersections at the joints. The blocks and their mouldings should be pressed so that the clay is of a uniform thickness, in order that the shrinkage may also

be uniform. When pressing a number of blocks to make up a length of straight moulding, or circular pieces for arches, the several pieces when nearly dry should be laid in the same position as they will appear when finally fixed, and then the moulding regulated at the joints and the whole made true and linable. The blocks are then numbered, and when dried the several joints can be tested, and any defects made good.

MITRES.—“Stuck joints” is a cheap way of forming internal and external mitres, returns, &c. The clay mouldings are cut to the desired angles, and the joints are keyed with a knife or a rough drag. Soft clay is then laid over the joints, and the two pieces rubbed together. This method is used to save the cost of making a model and a piece mould; but the work is not so sound as if pressed in one piece, and the cost, if less at first, is generally greater in the end, as a large number of stuck joints give or open when subjected to the ordeal of firing, or if they pass this ordeal, they are often rent asunder by the trowel when being fixed.

CASTING.—This method is only used for small work, such as small figures, vases, brackets, &c., and is only resorted to where numerous and cheap copies of work are required. A cast is in every way inferior to a squeeze. The moulds for terra-cotta casts are made of common plaster, or fine and coarse plaster mixed in equal proportions, and when gauged soft by using a liberal amount of water, it forms a porous mould, which absorbs the water rapidly from the cast. The cast is formed by making a smooth solution of fine clay, made about the consistency of cream. This solution is poured into the mould, which being porous, absorbs the moisture, and the solution adhering to the mould sets, leaving a coating of clay on the inner surface. This process is repeated until a sufficient thickness is obtained. The mould is then taken off, and the cast cleaned up, dried, and fired, as already described. All work taken out of a mould, whether pressed or cast, is usually termed casts.

DRYING.—The drying of terra-cotta casts requires care and regular attention to prevent them from warping, also to stop any cracks that may appear. The casts are placed in a drying-room, or, if the weather is good, in the open air. The drying should be regular. Sudden or irregular drying tends to twist or crack the casts. Long and open casts are liable to twist in drying. This may be partially, if not wholly, prevented by forming temporary clay struts on interior and exterior parts where most effective. When all is dry, the struts are cut away. Narrow interior struts can be left in.

FIRING.—The kilns or furnaces vary in size from 4 or 5 feet in diameter up to 20 feet. They are built of fireclay brick, and bound with iron hoop to prevent them bursting when red-hot within. The casts to be fired are packed in fireclay boxes, and stacked one above the other. This requires great care, as the casts may get damaged, or the heat may not get to all the casts, causing unequal burning, and consequently damaged work. When the kiln is full, the doorway is bricked up, and further secured by iron bolts. The fires are then lighted, and continued for three or four days. The processes of firing and cooling last from one to two weeks. A large kiln takes about a week to cool. The casts must not be taken out until cool, as the air would crack them. The firing is an important and anxious process, particularly if the works to be fired are originals, or of a delicate nature, requiring a certain amount of intensity and exposure, and no more. The degree of heat applied will render the work more or less hard, but excessive firing will vitrify and discolour the surface. When the works are taken out of the furnace, they will be found to have shrunk uniformly about one-twelfth, and to have changed colour, the final colour being one of the various shades of red or yellow, depending on the kind of clay used for the model. In some instances, in the case of a special model, it is placed in the furnace, and a firebrick wall built

up round it, to prevent the flames reaching the model. For small work, a cover, commonly called a "sagger," is used for the same purpose. In some kilns small pats of clay are put in with the other work, and at intervals an opening is made to allow a pat to be withdrawn, as a test to see whether it is properly or fully fired. Terra-cotta work in a greater or less number of repeated designs for architectural constructive or decorative work is often required, and the work, to ensure success with the least possible waste, must be done in a proper routine and method.

Muffle terra-cotta kilns are generally used for large work. Some are round in shape, and some are oblong. Their size varies from 10 to 13 feet in diameter by 10 to 17 feet in height. The muffle flues are about 5 inches spacing, and the thickness of muffle varies from 2 to 3 inches. The heat has an up-and-down draught, the heat rising upwards over the muffle flue, over the muffle crown, and downward through the centre flue (or chimney), thence under the floor. From there the heat passes upwards in flues built between the furnaces in the muffle space, and then into the dome on the side of kiln. There are six or seven furnaces to a kiln. In a good kiln three qualifications are essential: good combustion, even circulation, and durability of construction. In the production of one ton of terra-cotta ware nearly 700 lbs. of water, or more than 80 gallons, are required. Nearly 70 gallons of this moisture have to be evaporated in the process of drying, and the final 10 gallons pass off after the work is placed in the kiln in a form known as water-smoke. One of the hardest colours to obtain uniformity in the tint is the elegant buff, and to secure this rich pleasing colour in terra-cotta requires long burning and a perfect knowledge of firing, as well as a thorough acquaintance with the clay and its behaviour in the kiln. The principal kiln at W. Cubitt & Co.'s was designed by R. Green, a London plasterer.

FIXING.—Terra-cotta is usually fixed by masons. Hollow casts for constructional work are rendered stronger by filling them up with breeze concrete. The breeze should be freed from all small pieces of coal or other foreign matter, which are liable to swell and burst the shell.

TERRA-COTTA TRADE.—Terra cotta is now extensively used throughout the country for constructive and decorative building purposes. The production of the beautiful facina ware and general terra-cotta affords a considerable amount of work for modellers, model makers, and piece moulders; but however good these workmen may be in a plasterer's shop, they would at first feel strange in a terra-cotta manufactory. It is therefore hoped that the above instructions will prove of assistance to modellers and plasterers in their maiden efforts on terra-cotta.

CHAPTER XVIII.

CONCRETE.

HISTORICAL—BEIION AGGLOMERÉ—FINE CONCRETE—MATRIX—AGGREGATES—COMPOUND AND FIREPROOF AGGREGATES—SAND AND CEMENT—VOIDS IN AGGREGATES—CRUSHING STRENGTH OF CONCRETE—WATER FOR CONCRETE—GAUGING CONCRETE—RAMMING CONCRETE—THICKNESS OF CONCRETE PAVING—CONCRETE PAVING—METALLIC—EUREKA—EUREKA AGGREGATE AND QUANTITIES—LEVELS AND FALLS—SCREEDS AND SECTIONS—LAYING, TROWELLING, GROUTING, AND DUSTING—TEMPERATURE—NON-SLIPPERY PAVEMENTS—GROOVED AND ROUGHENED SURFACES—STAMPED CONCRETE—EXPANSION JOINTS—WASHING YARDS—STABLE PAVEMENTS—BREWERY PAVEMENTS—DAIRY AND FOOD FACTORY PAVEMENTS—STAFFORDSHIRE STONE PAVING—PETRURA PAVING—SUMMARY OF PAVING “IN SITU”—CONCRETE SLABS—MOSAIC—CONCRETE MOSAICS—ROADWAYS.

HISTORICAL.—The word concrete is of Latin origin, and signifies a mass of materials bound or held together by a cementing matrix. The Romans used concrete B.C. 500. They made good use of lime concrete both in the construction of buildings and roadways. “Roads,” says Gibbon, “were the most important element in the civilisation of ancient Rome; and the cost of the Appian Way was such as to entitle it to the proud designation of ‘Regina Viarum’ (the Queen of Roads).” The Appian (the oldest of the Roman highways) was commenced by Appius Claudius Cæus, when he was censor, about three centuries before the birth of Christ. It extended from Rome to Capua, whence it was subsequently carried on to Tarentum and Brundisium. Antonio Nibby, an archæologist of the highest authority, states that the Appian Way had an admirable substructure, with lime concrete materials superimposed, and large hexagonal blocks of stone laid on the top of all. The Romans built concrete aqueducts, often several miles long, to convey water to cities. The Palace of Sallust, the historian, was built about B.C. 50, and was frequently used as a residence by most of the emperors until as late as the fourth century. It was partly burnt by Alaric in the year 410. This once magnificent edifice was erected on a strange site, partly in the valley at the foot of the Quirinal Hill, and partly on the top of the hill. The latter portion of the palace, which was of great extent, has been almost wholly destroyed by the builders of the modern boulevard. The walls, which were thick and high, were most valuable examples of the Roman use of concrete, unfaced by brick or stone. There is still visible evidence, in the form of impressions left on those walls, which clearly demonstrates their method of casting walls *in situ* by means of wood framing. Rows of timber uprights, about 10 feet high, 6 inches wide, and 3 inches thick, were fixed along both faces of the intended wall. Boards about 10 inches wide and 1½ inches thick, in suitable lengths, were then nailed horizontally along the uprights, thus forming two parallel wooden walls, into which the concrete was laid and rammed until the space between the boards was filled to the top. When the concrete had set, the wood framing was removed, and refixed at the top of the concrete, the whole process being repeated until the wall was raised to the required height. This concrete was far more durable than brick or stone. The jerry-builders of modern Rome had no difficulty in pulling down the stone wall of Servius, but

the concrete walls required the use of dynamite to complete their destruction. After withstanding the wear and tear of many centuries, and the repeated onslaughts of the Goths and Vandals, it was left to the nineteenth-century speculative builder to destroy those interesting remains.

The use of concrete for floors and roofs is of great antiquity. It was employed for this purpose by the Romans in the time of Julius Caesar. Professor Middleton, in his first book, "Ancient Rome," states that the whole of the upper floor of the Atrium Vestæ is formed of a great slab of concrete, 14 inches thick, and about 20 feet in span, merely supported by its edges on travertine corbels, and having no intermediate supports. In his second book, "The Remains of Ancient Rome," Professor Middleton mentions that the Romans used concrete for the construction of the Pantheon, which was erected about the time of Christ. A curious and apparently unaccountable feature as regards practical purposes is that the concrete is faced with bricks, which were faced again either with stucco or (in special cases) with marble veneer. The Professor gives a sketch showing the exterior facing and the section of a wall of this kind, the entire mass being composed of concrete, except a facing of thin bricks, triangular in plan, with the points inwards. As the author observes, these bricks could not possibly be intended as a matrix for concrete, as it would not have withstood the pressure of the latter while in a wet state. It must therefore have been necessary to retain the brick and the concrete with an external timber framing, as in the case of unfaced concrete. There could be no gain of strength or other benefit to compensate for the time expended setting the brick skin. The dome of the Pantheon is 142 feet in diameter and 143 feet high. This is also formed with brick-faced concrete. It has often been described and even drawn by various authors as essentially a brick dome. Professor Middleton remarks there must have been very elaborate construction of centring for this and other massive concrete vaults. He states they employed a method, which has become common of late, to avoid the necessity of building up the centring from the ground. They set back the springing of the arch from the face of the pier, so as to leave a ledge from which the centring was built, the line of the pier being afterwards carried up until it met the intrados of the arch, leaving it a segmental one. The Professor also found signs of timber framing for walls in the remains of the Golden House of Nero, under the *Thermæ* of Titus, where, he says, "the channels formed by the upright posts are clearly visible. These upright grooves on the face of the wall are about 6 inches wide by 4 inches deep, and they were afterwards filled up by the insertion of little rectangular bricks, so as to make a smooth unbroken surface for the plastering." This method is difficult to understand. According to the present practice, the supports would be fixed outside the line of wall surface, and leave no spaces to fill in afterwards. He also mentions a striking example of the tenacity of good concrete in the *Thermæ* of Caracalla, at a part where a brick-faced concrete wall originally rested on a marble entablature supported by two granite columns. "In the sixteenth century," he says, "the columns and the marble architrave above them were removed for use in other buildings, and yet the wall above remains, hanging like a curtain from the concrete wall overhead." This proves that the Romans bestowed as much thought and care on the materials and their composition as they did on construction. Professor Middleton notes that the larger pieces of aggregate in the concrete, which are not close together, are so evenly spaced apart as to lead to the conclusion that they must have been put in by hand, piece by piece.

Dr Le Plongeon, during his explorations in Peru, found many remains of mud concrete walls. Although they were built many centuries ago, they have proved sufficiently durable to exist until to-day. The materials were placed between two rows of boards, and well beaten, and the exteriors were sometimes decorated with plaster work. Thus it appears that the Peruvian

builders of the period of the Incas anticipated by centuries the method (but not the material) of our modern concrete building. Le Plongeon's researches conclusively establish the fact that these Indians were masters of concrete building and plastering. The walls of the fortress of Ciudad Rodrigo in Spain are built of concrete. There are over 12 miles of arches and tunnels constructed with concrete in the Vanne Aqueduct, which supplies Paris with water. One of the arches over the Orleans Road, in the Forest of Fontainebleau, has a span of 125 feet without a joint, the arches and the water pipe or tunnel being entirely composed of béton, made with Portland cement, hydraulic lime, and the sand found on the spot. Concrete blocks weighing over 20 tons were used in the construction of the Suez Canal, 300,000 tons of these blocks being required at Port Said alone. The Albert Docks are made of concrete laid *in situ*. Douglas Harbour in the Isle of Man, and the Aberdeen Docks, are built of concrete blocks, and also the harbour of the North Sea entrance to the Amsterdam Canal. These are all lasting examples of concrete work.

Tall, Drake, Henley, Potter, and others have built entire houses monolithically with concrete. Concrete is the best known material for reservoirs, for which it is safe and sanitary. One of the finest examples is the Hanchurch Reservoir, Staffordshire, built by the Patent Construction Company, and designed by G. D. Harrison, C.E., Hanley. This reservoir is 225 feet long, 156 feet wide, and 21 feet deep. There were about 20 acres of concrete flooring laid at the Paris Exhibition of 1878. Mr Lascelles, of London, erected a house with concrete slabs at the same Exhibition, and was awarded a gold medal and the Cross of the Legion of Honour. The house was designed by Mr R. Norman Shaw, R.A. The pavement in "Old London," at the South Kensington Exhibitions, was laid with metallic concrete. It was estimated that this pavement was traversed by no less than 33,000,000 people, in addition to heavy loads, yet when taken up, when the site was required for the Imperial Institute, it showed no signs of deterioration or even of perceptible wear. The pavement and the stairs in the subway from the South Kensington Stations to the Exhibition Grounds, also formed *in situ* with metallic concrete, over which 27,000,000 people passed in three years, look as strong and as durable as ever, and show but little trace of wear. Owing to the great sanitary effect and jointless surface of concrete, it was used for paving the stables at Marlborough House, the London home of the Prince of Wales. This work, and that at "Old London" and the South Kensington subway, was executed by Wilkes' Patent Metallic Flooring and Eureka Concrete Company under my supervision. Important works in metallic concrete paving have also been executed for H.M. War Office, the Metropolitan Board of Works, Fire Brigade Stations, Railway and Tramway Companies, Vestries, Corporations, &c. The countless works executed by Messrs Wilkinson, Stuart, Cordingley, Ward, the Victoria Stone Company, the Imperial Stone Company, the Patent Paving Company, the Metallic Flooring and Artificial Stone Company, and others too numerous to enumerate, furnish indubitable proof of the value and suitability of concrete for architectural works and paving purposes. Besides the unquestionable durability of concrete, it also possesses fire-resisting and waterproof powers of the highest degree. Constructional works formed with concrete carefully made and applied may be considered absolutely fire-resisting and damp-proof; in fact, in these respects concrete has long since passed the experimental period, inasmuch as numerous tests, under the most trying and adverse circumstances, attest the superiority of this material for sanitary and durable work.

BÉTON AGGLOMÉRÉ.—The best concrete in France is that made under Coignet's system of "béton aggloméré," and has been used with great success in the construction of various large and important works. In Paris many miles of the sewers have been formed of this material; and a church in the Gothic style, from the foundations to the top of the steeple (which is 136 feet high), is

entirely formed of béton. The work was prosecuted without cessation for two years, and was exposed to rain and frost, but has not suffered in the slightest way from extremes of temperature. The strength of this material for constructive work may be judged by the thickness, or rather want of thickness, in the construction of a house, six stories high, having a Mansard roof—cellar, 19 inches; first story, 15 inches; second story, 13 inches; and diminishing 1 inch every successive story, so that the sixth story was 9 inches. The cellars have a middle wall from back to front, from which spring flat arches having a rise of one-tenth of the span, the crown being 5 inches thick, and at the springing 9 inches, which formed strong damp-proof and fireproof cellars. There are many houses in Paris constructed of this material. It has been used in London in the construction of sewers, &c. This concrete is composed of Portland cement, sand, and lime. Hydraulic lime is used for sewers and waterworks, and common lime for ordinary work. The lime is used in a powdered state. The whole of the materials are mixed in a dry state by hand, and afterwards gauged in a specially made pug-mill. The least possible amount of water is added by means of a fine jet while the pug-mill is in motion. The mixture is then spread in thin layers, and beaten by rammers formed of hardwood. The quantities for coarse work, where a fine face is not required, are—Portland cement, 1 part; common lime, $\frac{1}{2}$ part; gravel, 13 parts; coarse and fine sand, 6 parts. And for sewers—Portland cement, $\frac{1}{3}$ part; hydraulic lime, 1 part; sand, 6 parts. And for external work of good quality—Portland cement, 1 part; lime, $\frac{1}{2}$ part; sand, 7 parts. The above proportions are all by measure. Specimens of Cointet béton at two years old have attained a crushing strength of 7,400 lbs. to the square inch.

FINE CONCRETE.—No book on plastering would be complete without a description of the methods for working "fine concrete" here termed "fine concrete" to distinguish it from rough concrete as used for foundations, &c.), which is now coming into general use for paving purposes, staircases, and constructive and decorative works for buildings. Floors, roofs, and similar works which are finished with fine concrete, being within the plasterer's province, also demand description. The proper manipulation of the plastic materials, which is imperative for sound concrete, is undoubtedly plasterer's work. The higher branches of concrete work, for architectural construction and decoration, embrace model-making, modelling, piece-moulding, and casting. Concrete construction is therefore essentially a part and parcel of the plasterer's art and craft. The construction of concrete staircases *in situ* affords a striking example of the necessity of employing plasterers. Only a plasterer can manipulate the materials correctly, make the nosing mitres sharp and true, and set the soffits of the stairs and landings, and form a true arris at the stringing, whereas the non-plasterer leaves the work uneven, rough, and unsound. The non-plasterer can just manage to spread the stuff laid on the ground for him when laying paving, but he is entirely lost when the stuff has to be taken up on a hawk and laid with a trowel on an upright or overhead surface. He then gets upset, or rather he upsets the stuff. The non-plasterer possibly may have been an unfinished apprentice, or a dunce at his former trade, hence his trying another. These remarks are not caused by any hostility to other trades, but are inspired by the fact that many failures in the better class of concrete are due to the non-plasterer's incapacity in working, and his lack of knowledge of the materials. Portland cement concrete pavements were first used about fifty years ago. Its introduction, improvements, and subsequent rapid strides for paving, and in the construction of staircases, cast and made *in situ*, are due to plasterers. Mr W. B. Wilkinson, a well-known plasterer of Newcastle, was the pioneer of concrete paving in England. Mr P. Stuart, a Peterhead plasterer, was the first to introduce the well-known granolithic in Scotland. Messrs Cordingley, of Bradford, and J. Greenwood, of Crosshills, both plasterers, were the first concreters in Yorkshire—

Walker, a Leeds modeller, being the next in the field of concrete. The author, without being boastful, may fairly claim to be the first to conceive the idea of constructing concrete stairs *in situ*. There is another class of work done *in situ* with rough concrete for foundations, houses and other structures of a monolithic nature, on which, being done with more or less unskilled labour, further comment is unnecessary. Concrete is one of the best materials for paving the sidewalks of streets, abattoirs, stables, breweries, &c. It is jointless, impervious, non-slippery, and can be laid with a plain surface or grooved to any desired form. The only objection to paving laid *in situ* for streets is that when it is cut to repair or alter gas or water pipes, it is difficult to make good without the patches showing. This slight defect can easily be overcome by cutting out the whole bay where the patches are, or by forming a movable slab over the pipes.

There has been during recent years some controversy as to the department of the building trades to which laying concrete paving properly belongs. The claim is undoubtedly upheld in the strongest way for the plasterers. It will be remembered that this paving was originally introduced by Mr W. B. Wilkinson, of the well-known Newcastle-on-Tyne firm, himself a plasterer. The patents and improvements in the materials and methods of laying concrete paving have been introduced and followed up by plasterers. Metal rollers for indenting concrete surfaces were introduced by Mr P. Stuart, an Aberdeenshire plasterer. Eureka concrete paving, also the construction of concrete stairs *in situ*, were first introduced by the author. A further argument, if one were needed, to identify the operation as a plasterer's job, is that the tools, skill in which is necessary, are exclusively those of plasterers. The laying trowel and the hand-float are principally used, and none but plasterers exclusively employ them, no other workman in any branch of the building trades being habituated to their use. In every part of the world where concrete paving has been used it has been laid down by plasterers, so that it may be looked upon as their legitimate sphere of work.

Concrete is now extensively used in preference to earthenware for making sewer tubes. Experience has proved that the acids present in liquid sewage and the gases generated by the action of faecal decomposition do not injure the concrete tubes, but on the contrary tend to harden them. Among the many unlikely purposes for which concrete has come into use may be mentioned statuary, vases, fountains, sinks, tanks, cisterns, cattle-troughs, silos, railway sleepers, platform copings, chimney-pieces, chimney pots, tall chimneys, tombs, tombstones, and coffins. Concrete is slowly but surely coming to the front as one of the most useful, economical, constructive, and decorative materials for works requiring strength and endurance. It may now be said to be indispensable to the architect, engineer, and builder. Concrete, when properly made with a Portland cement matrix, and slag or a similar aggregate, is undoubtedly the best fire-resisting material used in building construction. It can be made thoroughly waterproof and acid proof, and may be moulded or carved to any design and coloured to any shade. After this brief historical review of concrete, the practical considerations of modern working by plasterers claim attention. Before describing the method of working the concrete, a description of the materials, with their characteristics and application, is given as a preliminary guide and reference. Notes on some of the most prominent pavings of the present day are also given.

MATRIX.—Matrix is a word used to designate any material having a setting, binding, or cementing power, such as limes, plaster, or cements. For concrete paving, stairs, floors, or cast work for external purposes, it may be truly said that there is only one matrix, namely, Portland cement.

AGGREGATE.—This is a term applied to those materials held or bound together by the matrix. Aggregates may be fibrous or non-fibrous, natural or artificial. The natural aggregates comprise

granite, stone, shells, marble, slate, gravel, sand, metal filings, &c.; the artificial, slag, brick, pottery, scharff, clinkers, coke-breeze, ashes, glass, &c.; and the fibrous, slag, wool, coir, fibre, reeds, hair, cork, tow, chopped hay, straw, shavings, &c. The fibrous aggregates, while being principally of a natural kind, are generally of a vegetable nature. They are commonly used with a plaster matrix for interior works. The best aggregates for the upper coat of concrete paving are granite, slag, and some of the hard limestones. The best and cheapest for the first layer or rough coat are broken bricks, old gas retorts, clinkers, whin and other stones. Stone chippings from masons' yards and quarries are cheap and good. Shingle and gravel are also used, but owing to their round and smooth surfaces they afford little or no key for the matrix. When found in large quantities and at a cheap rate, they should be broken to render them more angular, so as to give a better key. Aggregates are broken by crushing or stamping machines. In London, the stone aggregate used for casting figures, vases, and similar ornamental works is generally broken by hand.

Aggregates should be clean, and their surfaces free from mud and dust. Coarse aggregates are easily cleaned by turning on a strong stream of water from a hose. The aggregates should be laid on an inclined plane to allow the water and dirt to run off. The importance of a clean aggregate is seen from the fact that briquettes made from washed particles resist a tensile strain from 15 to 20 per cent. higher than those made from unwashed particles, when tested under similar conditions.

POROUS AGGREGATES.—All aggregates of a porous nature or having great suction should be well wetted before being gauged, to prevent absorption of the water used for gauging the matrix. A porous aggregate requires more cement than one of closer texture, and is not as strong. Water has no power to harden or set an aggregate. It is used to render the mass plastic, and to set the cement. No more than is necessary for this purpose should be used. Sloppy cement will not attain the same degree of hardness as a firm or stiff gauged cement, consequently it stands to reason that if the water or a part of it be absorbed by a porous aggregate, it will render the matrix, or that part next to the aggregate, friable and worthless. This may be proved by gauging a part of neat cement and spreading it on a brick, and another part on a slate. It will be found that the latter will set and become hard, whilst the former will either crumble before setting, or partly set, without getting hard. All aggregates are more or less absorbent, but while the porous kinds will absorb the water from the matrix, not only leaving the portions in immediate contact with the aggregate inert, but also weakening the whole body of the concrete, the non-porous have little or no absorption, water being retained in the matrix, or a portion may lie on the surface of each particle of aggregate, thus tending to harden the matrix and increase the general strength of the concrete. It may be thought that these defects are trivial, and can be overcome by thoroughly saturating the porous aggregate to prevent suction, but the fact still remains that after this or other excess water has dried out, the body of the concrete must still be porous, and this is one, if not the principal reason, why some concretes are not damp-proof. The quantity of matrix used for ordinary concrete being very much less than the quantity of aggregate, and the matrix not being of sufficient thickness to resist the force of atmospheric moisture, the damp finds a ready passage through the porous portions. A mass of porous aggregate will absorb external moisture, and this will gradually work through the body to the weakest or driest surface, or be retained for a time according to the state of the atmosphere. The extra keying power claimed for a porous aggregate is infinitesimal. It may be said not only to be of no value, but unnecessary, bearing in mind that in well-made concrete every particle of aggregate is enveloped with matrix.

Another point to be considered is the great tenacity of Portland cement to most clean surfaces, however smooth. Many men will have noticed how it clings and adheres when set to iron,

even to the smooth blades of trowels and shovels. The ultimate tenacity of neat Portland cement after being gauged twelve months is about 500 lbs. per square inch.

COMPOUND AGGREGATES.—The proper selection and use of aggregates for a true concrete is not secondary, but of equal importance to the matrix. As inferior aggregates are in the majority, it is advisable to take their defects into consideration. For concrete floors, roofs, and stairs, where strength, durability, and fire-resisting properties are imperative, gravel and coke-breeze as aggregates stand lowest in the scale. Owing to their abundance and cheapness, however, or for want of better materials, their use is often unavoidable. Their individual defects may be partly if not wholly corrected by a combination of two or more aggregates so as to balance their respective good and bad qualities. It is self-evident that the hard, non-porous, and incombustible nature of gravel will correct the soft, porous, and combustible nature of coke-breeze, and that the light, rough, angular, and elastic nature and variety of size of coke-breeze will counterbalance the disadvantages of the heavy, smooth, round, and rigid nature and uniformity of size of gravel. The strength, irregularity of size, and form of broken bricks, and its incombustible nature, causes it to be a direct gain to either of the above. The mixing of various aggregates may seem of small importance, but if by their judicious amalgamation the strength is enhanced, or the weight or cost of the material decreased, or again, if the practice enables any waste or by-product to be utilised, then the advantage becomes obvious. To argue by analogy, it is well known that it is by the judicious combination and manipulation of various materials that mortars and cements attain their strength and hardness, therefore the same course will give equally good results with concretes, while rendering economy with safety possible.

The compressive and tensile strength of concrete is influenced both by the matrix and the aggregate. Aggregates which are uniform in size, (or if of various sizes, which are not graduated in proportion to each other, or having their surfaces spherical, soft, or dirty, will not bind with the matrix, or key or bond with each other, so well as those which are of various graduating proportional sizes, and have their surfaces hard, angular, and clean.

SAND AND CEMENT.—Sand is extensively used as an aggregate in Portland cement for cast work, mouldings, and wall plastering. Fine sand does not give so good results for strength as coarse sand, and a hard-grained sand is more durable than a soft one. Ground brick-bats or pottery, sandstone and flints, fine gravel, smithy ashes, and coke-breeze are often used as substitutes for sand.

It has generally been assumed that sharp coarse Thames sand is one of the best and strongest for gauging with cement, but, according to experiments made by Mr Grant, clean sharp pit sand gives better results, as he found that whereas test briquettes having a sectional area of $2\frac{1}{2}$ superficial inches, composed of equal proportions of Thames sand, broke at the end of twelve months with a tensile strain of 724 lbs., it required 815 lbs. to break briquettes composed of equal parts of cement and pit sand. With reference to various sands suitable for making mortar with cement, Mr Grant's experiment is of a most surprising nature, as it indicates that sand made from ground clay ballast, or ground brick—which are identical—and Portland stone dust, were superior to pit or sea sand, or smiths' ashes.

The following table shows the results of tests of various aggregates made by Lieutenant Innes, R.E. The briquettes were composed of Portland cement, sand, or other aggregates, in the proportion of 1 to 2, and were kept in water for seven days.

TABLE IX.—TESTS OF VARIOUS SANDS, &C., AND CEMENT.

Nature of Sand, &c.	Voids per cent.		Shrinkage per cent.	Grains above $\frac{1}{16}$ inch.	Tensile Strength in lbs. per square inch.			
	Dry.	Wet.			Three Weeks.	Proportional Value of Sands.	Three Months.	Proportional Value of Sands.
Neat cement - - - - -	450	...	529	...
Sea sand, roughish and uneven grain, chiefly siliceous, clean - - - - -	38	34	6	94	140	52.4	249	70.1
Sea sand (drifted), siliceous, clean - - - - -	43	39	11	8	60	22.3	193	54.3
Pit sand, containing small shells, &c., grains of unequal size, siliceous - - - - -	32	19	16	15	108	40.1	248	69.8
Pit sand, grains smooth and uniform, siliceous, clean - - - - -	41	34	11	76	94	34.9	175	49.8
Portland stone dust, grains rough and irregular, clean - - - - -	46	34	18	56	165	61.3	254	71.5
Smithy ashes, containing much unburnt coal-dust, grains rough and irregular - - - - -	64	52	25	56	38	14.1	91	25.6

It will be seen that Portland stone dust gave the best results, and the others follow in this order—coarse sea sand, rough pit sand, smooth pit sand, drifted sea sand, and lastly smithy ashes. If the dust had been eliminated, the tests would be more valuable. The degree of coarseness has a considerable influence on the strength of concrete and mortar. Fine sand makes weaker mortar than coarse. The following table gives the results of two series of tests carried out by Mr Grant. The cement was sifted through a sieve with 2,580 meshes to the square inch, and was made into briquettes with 3 parts of sand by weight. All the briquettes were kept in water.

TABLE X.—TENSILE TESTS OF PORTLAND CEMENT AND SAND COARSE AND FINE.

No.	Sand tested by Sieves.	At 25 days.	70 days.	91 days.	112 days.	133 days.	154 days.
		lbs.	lbs.	lbs.	lbs.	lbs.	lbs.
<i>First Series—</i>							
1	1 cement to 3 sand	78.5	113.9	116.9	142.3	178	205.5
2	ditto.	137.1	239.5	223	231.5	254.5	251.5
<i>Second Series—</i>							
3	1 cement to 3 sand	117.2	134.5	145	150	157.8	213
4	ditto.	212	239.5	209	253	207.5	273.5

In the above each figure is the average of ten tests, the result being given in lbs. per square inch. The sand used in tests 1 and 3 passed a sieve with 400 meshes to the square inch, and the sand used in tests 2 and 4 through a sieve with 100 meshes to the square inch.

FIREPROOF AGGREGATES.—The selection of the best known fire-resisting aggregate for fire-

proof concrete construction is of vital importance. Granite, stone, and flints splinter and crack when subjected to great heat, or to the sudden reaction caused by the cold water used for extinguishing fires. Coke-breeze is a great conductor of heat, and is also extremely porous and generally weak. Coke-breeze concrete, when under the influence of intense heat, as for example in the midst of a building on fire (stated by Captain Shaw to be from 2,000 to 3,000 Fahr.), will gradually calcine and crack, and finally fall to dust.

Slag is one of the best fireproof aggregates. It is a well-worn axiom that "what has passed through the fire will stand the fire." There is no other material that has passed the ordeal of fire like slag. Its great hardness, density, and angularity (when crushed) all tend to make it one of the best substances for fireproof construction. Slag is cheap and abundant, but requires great care in selection, as some kinds contain a large amount of sulphur, which is very detrimental to Portland cement, causing the concrete to blow and expand. The presence of sulphur can often be detected by the smell alone. When sulphur is present in a heap that has lain for some time, or sufficiently long to allow the atmosphere to cleanse the outer surface, it is more difficult to detect. A hole should then be dug in the heap, and the presence of sulphur can be ascertained by smell, heat, and colour. It will smell strong, and if new will be warm, and show yellow patches. The power of the sulphur is so great that washing the slag once will not entirely cleanse it. In some cases frequent washings and long exposure to the air is necessary. There are some slags that are free or nearly so from sulphur, and which can be had direct from the iron furnaces. The slag from the Kettering coal and iron furnaces is largely employed for concrete paving. It is hard and practically free from sulphur. The best size is $\frac{3}{4}$ -inch screenings. This when sifted yields a fine kind for topping, and the residue is useful for the rough coat.

The next best fire-resisting aggregates are fire-bricks, pottery, scharff, hard clinkers, and pumice-stone. The last has the advantage of being extremely light, but it is too soft for frictional wear. Coke-breeze may to a certain extent be deprived of its combustible nature and rendered more fire-resisting by washing and passing it through a $\frac{1}{4}$ -inch sieve, then adding 1 part flowers of sulphur and 10 parts fine broken bricks to 20 parts of coke-breeze. The larger breeze rejected by the sieve can be broken small, or used for internal layers of concrete. The bricks should also be passed through a $\frac{1}{4}$ -inch sieve. The finer the breeze and brick, the better for receiving and retaining nails.

VOIDS IN AGGREGATES.—The quantity of voids or interstices depends on the shape and size of the aggregates. The least quantity of voids will be found in those aggregates which are broken small, and contain pieces of various sizes. Gravel free from sand contains about 30 per cent. of voids, and broken stone of uniform size about 50 per cent. Sand is often mixed with gravel, stones, &c., to lessen the quantity, or fill the voids, so as to ensure the full strength of the concrete, without adding more cement than the proper ratio. The following method is used to ascertain the voids in aggregates:—Fill a box of known capacity with damp, broken aggregate; start shaking it during the operation; then fill the box to the brim with water; the quantity of water is the measure of the voids in the aggregate. Having now briefly reviewed the characteristics of the aggregates most used, the practical conclusions to be drawn are that they should be angular in form, hard in nature, graduated in size, and clean.

CRUSHING STRENGTH OF CONCRETE.—The crushing strength of concrete depends upon the ratio of cement, and the nature of the aggregate. Another important factor is compression, done by beating and ramming. Compression increases the weight of concrete about 4 per cent., and the strength about 25 per cent. The following table shows the crushing strength of concrete made

with Portland cement and various kinds of aggregates as given by Mr Grant. The tests were made with 6-inch cubes. One-half were compressed by beating the concrete into the mould with a mallet; the other half were not compressed. The whole were kept in the air for a year before being crushed.

TABLE XI.
CRUSHING STRENGTH (IN TONS PER SQUARE FOOT) OF PORTLAND CEMENT CONCRETES
HAVING VARIOUS AGGREGATES.

Nature of Aggregate.	Six to One.		Eight to One.		Ten to One.	
	Compressed.	Not Compressed.	Compressed.	Not Compressed.	Compressed.	Not Compressed.
Ballast - - -	81.6	72.8	54	50	42	32
Portland stone - -	162.4	120	132	98	88	76
Granite - - -	122	98	78.4	58	62	46
Pottery - - -	115.2	98.4	88	72	74	56
Slag - - -	92	80	78	56	42	34
Flints - - -	82	62	70	56	60	51.2

The granite and slag might have been expected to have given the better results. It is probable that they were unwashed, and contained a considerable amount of dust. If the compression was done by hydraulic power, so as to obtain a uniform compression in all the cubes, the results would be more reliable.

WATER FOR CONCRETE.—Water for concrete should be perfectly clean, and free from organic and inorganic impurities. As regards the quantity, it can only be said that for such purposes as the foundations for paving, casting blocks, &c., or where the material can be well rammed, so as to ensure perfect consolidation, less is required than where the concrete can only be poured or laid in position. When mixed with insufficient water, the concrete occupies about one-eighth more space than when mixed with the full quantity, and percolation through the former gauge would be greater than through the latter. Yet by thorough ramming the former would occupy less space and offer greater resistance to moisture. An over-watered gauge is slow to set, difficult to work, liable to surface cracks, and often there is a loss of strength, caused by e-scape of a portion of liquid cement. The work will also be unequal in strength, owing to the liquid cement flowing to various or lower parts, leaving parts of the aggregate bare and weak.

It must not be inferred from the foregoing remarks that water is entirely unnecessary or of little value for concrete. On the contrary, it is of the utmost value. The evil is in the abuse, not in the use. Portland cement has a great affinity for moisture. For instance, if a sack of cement is left on or in a damp place, a part of the contents soon becomes set and extremely hard, which is a proof of its affinity, and that moisture alone will set cement without water, far less excess of water. Fresh cement requires more water than stale cement. Cement gauged with sea water sets more slowly than with fresh water. Sea water should not be used in concrete intended for paving stables, chemical tanks, or similar places where it will come in contact with ammonia. Sea water having a lower freezing-point than fresh water, is sometimes used in frosty weather to

allow the work to be carried on. It ought not, however, to be used for external work, especially for plastering façades, as it has the property of attracting moisture and causing an efflorescence on the surface. Sometimes in frosty weather hot water, also hot lime, is used for concrete; but although they hasten the setting, they often prove fatal to the strength of the concrete. Excess of water retards the setting and hardening of concrete; it also washes away some of the finest and best particles of the cement during the gauging. A part of the water also forms in little globules throughout the mass, and when the water-drops evaporate a series of small holes or blubs is left, which deteriorates the strength of the concrete. Finally, it may be stated that the quantity of water required for gauging concrete is regulated by the class and condition of the aggregate, by the state of the atmosphere, and by the purpose for which the concrete is required. Another important point is the careful and thorough incorporation of all the materials when gauging. A mass of raw materials, if gauged carelessly, will require more water to attain the same plasticity as that which is carefully gauged. Approximate quantities of water are given for Portland cement plastering. For concrete the quantity is about 21 gallons of water to 1 cubic yard of dry materials, or about 1 part by volume to 8 parts. It is a good maxim to bear in mind when mixing water for gauging concrete, that other things being equal, the minimum is better than the maximum. Water may be said to give birth to the strength of cement; to carry the simile further, the aggregate may be termed the bone, the matrix the skin and sinew, and the water the blood of concrete.

GAUGING CONCRETE.—It is a common idea that concrete can be gauged and used anyhow, with any aggregate, or with any amount of water; and in consequence of a laxity in supervision in the selection of the materials, and their correct gauging and manipulation, unsatisfactory results are sometimes arrived at, the blame being attributed to the wrong cause. Gauging concrete requires considerable care to avoid waste of materials and obtain the best possible work. Concrete can be gauged either by hand or by machinery. For small quantities, such as for stairs and similar work, the former is almost invariably used; and for large quantities, such as for foundations of buildings, &c., the latter, being more economical, is preferable. Mr R. E. Taylor, C.E., of Newcastle, has invented a mixing machine which can manipulate $\frac{1}{2}$ cubic yard at a time by hand. A careful and uniform method should be employed for hand gauging; nothing should be left to chance or rule of thumb. The gauge-board should be sufficiently large to allow the materials to be turned over without spilling, it should be placed as near the work as possible, and it should be cleaned after each gauge.

For fine concrete, no more than 1 cubic yard should be gauged at a time. This is as much as three men can properly gauge at once and in the proper time—that is, before the “initial set” begins. Portland cement concrete, unlike some mortars, does not improve by prolonged working. If larger quantities are desirable, then more men must be employed in the gauging. All materials should be measured for each gauge, to ensure uniform setting and strength, and also the best work. This, combined with the saving of time and materials, will repay a hundredfold the cost of the measures. It is a common yet a wrong way, when gauging for paving purposes, to measure the aggregate by so many barrowfuls to a sack of cement. Neither the aggregate nor the cement can be accurately measured in this haphazard way. No man fills a barrow twice alike, and the cement being turned out of the sacks direct on to the aggregate is apt to vary, as it may contain lumps caused by clump, and very often some of the finest of the cement is retained in the sack, as more often than not it is simply drawn up and then thrown on one side without shaking it, as would be, or at least should be, done if the cement was emptied for air-slaking. The aggregate should be measured in a bottomless box or frame with handles at the ends, the cement in a box (with a bottom), and the

water in a gallon metal measure or a pail made to contain 4 gallons. Five pailfuls of this size are about sufficient to gauge 1 cubic yard where the concrete can be well rammed or punned. For work that is simply laid, 1 gallon extra is required. The box frame is laid on the gauge-board and filled with aggregate (in a damp state). The frame is lifted off, and the aggregate spread over the board until about 6 or 7 inches thick. The cement is then distributed over the aggregate. The materials are then gauged by three men, two with shovels and one with a rake or larry, the former facing the latter. The dry materials should be carefully but energetically turned over twice, and then when being turned over the third time water must be gradually added by means of a rose fixed on a water-can. Water poured from a pail is apt to wash parts of the cement away; the water also cannot be so regularly and gradually distributed over the dry materials as when a rose is used. The mass is again turned over twice or even thrice until thoroughly incorporated. This turning over does not consist of merely turning the mass over in the centre or on one place of the board, but to be effectively done a shoveller should stand at each side of the board, and the raker at the end to which the mass is to be first turned; the shovellers lift the stuff and spread or rather scatter it on one end of the board with a jerking motion, and the raker further mixes the stuff by working each shovelful backwards and forwards. This is repeated, the stuff being turned to the other end of the board, after which it is turned to the centre, the water being added as already described. The wet mass is then turned over twice in a similar manner, and finally finished in the centre of the board. The shovellers in the final mixing turn the stuff from the outside of the heap to the centre, while the raker gives the final touches. After being gauged, it should not be disturbed, but immediately shovelled into pails, and conveyed to the place of its use. The "initial set" begins nearly or as soon as gauged, and any after or unnecessary disturbance tends to destroy the setting properties of the cement. The practice of gauging, and afterwards regauging or knocking it up, is most objectionable, as it destroys its setting properties. No more should be gauged at one time than can be conveniently laid in one operation. The gauging of this valuable material should not be left entirely to unskilled labour, but ought to be carried out under careful supervision.

RAMMING CONCRETE.—The ramming, beating, or punning of concrete is of great importance. It compresses the concrete, rendering it more dense and free from voids, and forces out all superfluous water. The resultant gain in strength, durability, and imperviousness is by no means to be despised. Without compression it is impossible to obtain impervious concrete. Prolonged ramming, however, is dangerous, as it may be continued until the cement is set, which would be a direct loss of strength. For this reason, the ramming of concrete made with quick-setting cement should immediately follow the deposition of the material, and be expeditiously done. The concrete should always be gauged rather stiff than soft. If in the latter form, the ramming will separate the more fluid portions, and produce strata of different densities. When the concrete is deposited in layers, the joints of each layer, if dry or exposed, should be well swept and watered before the next layer is deposited. It is often advisable, especially in very dry work, to brush the joints with liquid cement after they have been swept and wetted. For large constructional work, the joints should also be keyed by aid of a pick, or by inserting stones at intervals into the concrete before it is set, leaving them projecting 3 or 4 inches above the level of the joint. Another method of forming a key is effected by forcing a batten on edge about 2 or 3 inches deep into the concrete, at the middle of the joint, and when the concrete is firm or nearly set the batten is extracted, thus leaving a groove which forms a key for the succeeding layer.

No layer that has to be left for some time, or until dry, should be less than 4 inches deep. Thin layers are always a source of weakness. If the successive layers can be laid before the

previous one is firm or set, the thickness is not of so much consequence. For large work, when each layer has to stand until set, the thickness may vary from 9 to 12 or even 18 inches. Ramming may be done by using an iron punner, or one made of hardwood and bound with iron. Wooden mallets and punches or iron hand-floats are most suitable for ramming stairs and cast work. The gain in strength is shown in Table XI. of the crushing strength of Portland cement concrete.

THICKNESS OF CONCRETE PAVING.—The thickness of concrete paving laid *in situ* is regulated according to the purpose and the position of the work. The thickness also depends upon the nature and solidity of the foundations. It is obvious that a thicker paving is required for a foundation that is weak or soft than for one that is strong and hard. The best foundations are those composed of strong and well-laid rough concrete. Foundations composed of broken bricks or stone thoroughly consolidated by ramming are the next best. The thickness of foundations is also regulated by the nature of the soil and the subsequent traffic. Paving for the side-walks of main streets, or where the traffic is heavy and continuous, should not be less than 2 inches. For a medium traffic, and on a strong foundation, a thickness of 1½ inches will be sufficient. For side streets, garden paths, passages in houses, or similar places where the traffic is light and limited, a thickness from 1 to 1½ inches will be ample if on a rough concrete foundation; but if on a "dry," *i.e.*, broken brick or stone one, the thickness should not be less than 1½ inches. The thickness for stable floors may vary from 3 to 4 inches, according to the class of horses. For instance, a thickness of 3 inches would be ample for race or carriage horses, but 4 inches is necessary for heavy cart horses. The same rule applies to yards, a thickness of 3 or 3½ inches being sufficient for carriages, while 4 inches is required for carts, waggons, &c. Factory floors are generally made 2 inches thick, but where there is machinery or wheel traffic a thickness from 2½ to 3 inches is employed. By computing the volume and nature of the traffic, and comparing the tests of concrete paving herein given, the requisite thickness will be readily obtained. It must of necessity greatly depend on the class of the materials and manipulation used for the paving. Like most other articles, a good material will go further and last longer than a bad one.

CONCRETE PAVING.—Good pavements proclaim a city's progress. Isidorus states that the Carthaginians were the first people to pave streets. The subject of paving and floors will be best understood by dividing it into two parts—namely, paving, which is a floor surface laid and resting on solid ground; and floors, by which are meant floors over voids. The following items briefly embody the processes used for most concrete pavings now in use. The method of laying is detailed in Eureka concrete. Paving *in situ* is either laid in "one coat" or "two coats," the latter being in more general use than the former, yet each method has its individual merits. One-coat work is not so liable to rise or laminate as two-coat work. It takes slightly less labour, the whole thickness being laid in one operation. The aggregate is either granite or slag, or both in equal proportions, gauged with Portland cement in the proportion of 2 of the latter to 5 of the former. Two-coat is laid with two different aggregates and gauges. The first coat has a cheap aggregate, such as ballast, clinkers, bricks, or whinstone, broken so that they will pass through a 1-inch mesh riddle, and gauged in the ratio of 1 of Portland cement to 5 of the aggregate. It is laid till within 1 inch of the finished surface. The second coat is laid as soon as the first is set, and is composed of 1 part of Portland to 2 of aggregate, the latter being either crushed granite, slag, limestone, or whinstone that will pass through a ¼-inch sieve. In some districts fine shingle is used for the topping aggregate.

PATENT METALLIC PAVING.—This is one of my patents, which, under the title of Wilkes' Metallic Flooring and Eureka Concrete Company, was extensively used in Great Britain and Ireland

and the Continent. The Austrian and Belgian patents were worked in both countries. This paving was awarded a gold medal at the Health Exhibition, 1884; a gold medal at the Architectural and Building Exhibition, 1886; and the only gold medal at the Firemen's Exhibition, 1886, as well as five diplomas of merit. The materials and method are nearly the same as that described for Eureka; but in order to avoid waiting for a considerable time which it is usual to do in concrete work, before it can be used for traffic, I invented a quick-setting solution, termed "Reekie," to accelerate the setting. For this rapid concrete 5 per cent. of Reekie is added to the concrete materials. The following extracts refer to the paving, and to the Reekie or quick-setting solution. *The Engineer*, 1885, after referring to the various works done with this matter, says: "A feature of the invention is the rapidity with which the composition sets. For instance, a roadway was finished at the Inventions Exhibition at seven o'clock one night, and at six o'clock the next morning 4 or 5 tons of paper in vans passed over it into the building, without doing any harm to the new road." In laying down roads, much of the preparation of the material is done on the spot, and the composition after being put down unsilicated in a large layer, has the required design stamped upon its wet surface by means of wooden or gutta-percha moulds. Sometimes the grooving is made in imitation of ordinary granite paving setts. In tramway pavements there are grooves to give a grip to the horses' feet, and a slight camber between the rails. The great advantage in laying a pavement by this method is, that when any repairs are necessary, a piece of the exact size can be manufactured at the works and stamped to the same pattern as the adjoining pavement, then placed at once in position on the removal of the worn portion, thus saving the time necessary for setting on the spot. The following is taken from a series of articles on artificial stones, which appeared in *The Builder* in 1888:—"For Wilkes and Millar's patent paving stone, which is stated to be hard, durable, and non-slippery, a mixture is employed of finely powdered and washed blast-furnace slag, 3 parts to 1 part of hydraulic cement, to which is added sufficient water, containing in every gallon 1 part of bittern water, 5 per cent. of carbonate of soda, 2½ per cent. of carbonate of ammonia, and a little potash. If 1 ounce of sulphate of lime is added to this solution the stone will set more quickly."

Quick-setting solutions are used to reduce the time required to allow the paving to harden before it is available for traffic. Many pavements are ruined by being used before having become sufficiently set and hard. Many of the so-called quick-setting materials have the desired effect of setting the concrete quickly, but the work in many cases is subject to subsequent blowing, expanding, and cracking. On no account should these quick-setting materials be used, unless thoroughly tested and the concrete proved durable by use and time. In order to protect the surface and allow the paving to be used immediately, P. M. Bruner, an American engineer and concrete specialist, covers the surface of the pavement directly it is finished with a thin coat of plaster or Parian cement, which admits of walking upon in a few hours, and resists pedestrian traffic until the surface proper is sufficiently hard, after which it is shelled off with a trowel.

EUREKA PAVING.—I have retained the term Eureka for an improved concrete, which has been extensively used with good results for many purposes, such as pavements, floors, and stairs. Eureka, if not exactly one-coat work, is nearer that than two-coat work, and may be said to be the happy medium, or a combination of both. Eureka is laid in two layers. The first is termed the "rough coat," and the second the "fine coat" or "topping." The topping is laid nearly as soon as the rough coat is laid, just as in rendering or dubbing-out plaster work. The materials and gauges are nearly alike for both layers. The gauged rough stuff is laid on the foundation, previously wetted to prevent suction, and spread and beaten with an iron hand-float. The laying, spreading, and beating are continued until the rough surface is within ½ inch of the finished line. The surface

of the rough coat is made fair, and a uniform thickness for the topping is obtained by passing a "gauge-rule" across the surface. A uniform thickness of topping gives an equal expansion, therefore the surface is not liable to crack. The suction is also more regular, which permits of the trowelling to be done with greater freedom, and without causing hard and soft places on the surface.

As many alternate bays are laid as will allow of all being topped and finished the same day. When the number of bays to be laid in on one day has been decided, and the last one roughened in, the first bay will be firm to receive the topping. The topping is laid and spread with a wooden hand-float, ruled and trowelled and brushed as afterwards described in the general process. This method of laying a part of the thickness of the paving, gauging stiff and beating the mass, forces it into the interstices of the broken dry foundation, and not only consolidates the foundation and the rough coat, but also forms a solid bed to receive the topping. The topping goes in sooner and more regularly on a stiff-gauged and well-beaten coat than on a soft-gauged one, or than if the whole thickness of the paving were laid in one coat.

EUREKA AGGREGATE.—The method of preparing the aggregate for Eureka is of the utmost importance. The labour expended on its preparation is more than repaid, not only in the ease and rapidity when finishing, but also in the satisfaction of doing a strong and workmanlike job. Slag or granite is far more preferable to gravel or stone as an aggregate. Slag and granite in equal proportions have been used with good results. The size ordered from the furnace or quarry should be $\frac{3}{4}$ -inch screenings. It must be washed through a $\frac{1}{2}$ -inch sieve in a tub or iron tank. The coarse part rejected by the sieve to be laid aside for the rough coat. The fine aggregate is then washed again through a fine sieve to extract any mud or impalpable powder, as the presence of such impurities weakens the consolidating power of the cement, and decreases the ultimate strength of the concrete. This fine aggregate for the topping should be angular and of various graduating sizes, from that of fine sharp sand to the largest size that has passed through the $\frac{1}{2}$ -inch sieve. It has been proved by experience and the test of time that an artificial stone made with a fine aggregate has not only more resemblance to the grain or texture of natural stone, but is also denser, and wears better and with more uniformity, than one made with a large, round, or equal-sized aggregate. The use of small and angular aggregate of the graduating sizes ensures their fitting closer and interlocking together, thus forming a stronger bond, giving a regular key and freedom for each separate piece to be coated with cement, the whole forming a solid and homogeneous body with a hard surface. Concrete with large or round aggregate, and the various pieces disproportionate in size to each other, will fit loosely and unevenly, and only touch at their most prominent points, thus leaving voids, and consequently unsound work. The voids may perchance be wholly or partly filled with matrix, still this is an unnecessary waste of cement. Consequently, concrete paving having large or round aggregate wears unevenly, and leaves the large or round pieces uncoated and loose, or so exposed above the surface that they soon get dislodged, leaving a series of small holes, which sooner or later wear larger and larger. Another point of importance is that concrete with a fine hard aggregate is more plastic, works freer, and has a greater compressive strength than concrete with a large or soft aggregate. Eureka concrete, having a fine, clean, and regulated aggregate, should be used for the topping of paving, steps, landings, or for any class of work exposed to friction or wear. It is well to remember that a good matrix will not make a bad aggregate strong, although a bad aggregate will make a good matrix weak, or rather the resultant concrete weak.

EUREKA QUANTITIES.—The quantities for the rough coat are 1 part of Portland cement and

4 parts of the coarse portion of Eureka aggregate. These materials must be gauged stiff, only as much water being used as will allow the mass to be thoroughly mixed and plastic. The quantities for the topping are 2 parts of Portland cement to 5 of fine aggregate, and gauged about the consistency of well-tempered "coarse stuff," as used for floating. Experiments prove that neat cement is inferior in wear-resisting qualities (such as frictional wear and pedestrian traffic, to mixtures of cement with sand or other aggregate, being in fact equal to a mixture of about 1 part of cement to 3 of aggregate. The best wearing qualities are obtained by a mixture of 2 parts of cement to 3 of aggregate.

LEVELS AND FALLS.—Accurate levelling and adjustment of the requisite falls are important features for pavements and flooring. Levelling is the art by which the relative heights of any number of points are determined. Falls are used to allow rain and water used for cleansing purposes to run off into channels and drains. The levels and falls in good buildings are generally marked on the drawings, but it is imperative that the worker should be conversant with the necessary amount of falls for paving purposes, as many unforeseen difficulties often arise in this class of work, especially in large surfaces. The most accurate and speedy way of setting out levels and falls is of special service to concrete paviors. The importance of these features will be readily appreciated, especially where these paving preliminaries are left to the care of the concrete layers. The amount of cross fall for street pavements varies according to the class and position of the work. The fall is also regulated by the gradient. For a level stretch of paving it is generally 1 in 60, therefore for a pavement 6 feet wide it would be 1 inch. The fall for rising ground is usually $\frac{1}{4}$ inch for every 2 feet in the width of the pavement. The falls for stables and yards are given under their respective headings. The points for levelling—also for falls—are formed by driving wooden pegs into the ground at the most suitable points. The heads of the pegs represent the finished face of the pavement. They are made level with each other by the aid of a parallel rule and a spirit-level. Intermediate pegs may also be levelled by means of boning rods, the use of which is explained in the Appendix.

PAVEMENT FOUNDATIONS.—Good foundations for concrete paving are of primary importance, and unless the bottom is firm, and the foundation sound, the best made and laid concrete will subside, crack, and be permanently spoilt. Pavements generally cover a large area, and the superstructure, however strong, must have a firm foundation. Foundations consists of two parts—the first is the bottom ground or natural foundation; the second is the made-up or artificial foundation; but for simplicity the first part is termed the "bottom," and the latter the "foundation." The latter may be "dry" or "gauged." If the bottom is soft, it must be well rammed before laying the dry materials for the foundation, or a layer of common coarse concrete for gauged work. When excavating the ground to receive the foundation, the depth from the intended finished surface of the pavement should be about 5 inches for paving 2 inches thick, 6 inches deep for paving $2\frac{1}{2}$ inches thick, and 7 inches deep for paving 3 inches thick. The above depths are for dry foundations, and where the traffic is light, such as side-walks, playgrounds, and passages. If the bottom is soft, or the paving intended for heavy traffic, the depths may be increased, and the bottom well rammed before the materials are laid. The materials for dry foundations are broken bricks, stone rubble, or other hard core. They should be spread on the bottom, and broken *in situ*. The breaking *in situ* tends to consolidate the bottom and foundation. When broken, no piece should be left that will not pass through a $2\frac{1}{2}$ -inch ring. If the paving is intended for heavy traffic (carts or the rolling of heavy casks), it is best to have a rough concrete foundation. The rough concrete should be from 4 to 7 inches deep, according to the firmness of the bottom and class of traffic. This concrete is composed of ballast or equal parts ballast and broken bricks.

coke-breeze, or hard clinkers, gauged in the proportion of 1 of Portland cement to 5 or 6 of aggregate. It should be laid to the desired fall. If lime instead of Portland cement is used for the rough concrete, great care should be taken to thoroughly damp the surface, and allow a sufficient time for the lime to expand and any lumps of unslaked lime to slake, before the fine concrete is laid. No paving should be laid until the rough concrete is thoroughly set. Allowance must also be made for any settlement of the bottom, and for any subsidence, contraction, or expansion of the concrete foundation. The rough is not so liable to contraction or expansion as fine concrete, but it is more liable to subsidence. Expansion is due to the cement, not to the aggregate; and as there is less cement in rough concrete than in fine, it has less power of expansion, and owing to the greater amount and weight of aggregate, there is the lesser power of contraction. The size of aggregate for rough concrete is also larger than for fine; consequently each piece offers a greater resistance to the cement. Subsidence is due to the settlement by gravitation of the aggregate to the bottom, which takes place after the excess water, or even the liquid cement, has percolated through voids or spaces of badly made or laid concrete. Unequal subsidence is caused by bad and unequal gauging; one gauge being firm keeps in position; while if soft and sloppy, the excess water either settles in the deepest places, or escapes into the ground, thus allowing the body of the concrete at those parts to subside.

SCREEDS AND SECTIONS.—Screeds are used as guides and bearings for levelling and ruling off. They are generally formed with wood rules, planed on all sides, and in suitable sizes, and are termed "screed rules." Screeds are sometimes formed with the same kind of material as used for the pavement, and are termed "gauged screeds." Screed rules give the best results; they are speedily laid, can be used at once, and form a clean and square joint when laying work in sections. Screed rules are temporarily fixed on the foundations by laying them on narrow strips of gauged concrete, and then made straight, and to the proper falls, by laying the edge of a straight-edge on them, and tapping with a hammer till firm and true. When the bay is finished and set, the screeds are removed by gently tapping with a hammer, leaving a clean, straight, and square joint. Where there is only a small quantity of screeds required, or where time will not permit of waiting for the concrete bedding strips to set, the screed rules can be fixed on gauged plaster, which allows the screeds to be used at once. The plaster should be cleaned off at the side intended to be laid, to ensure a sound bed for the concrete, and a square joint. Gauged screeds may be also formed with gauged coarse plaster. They are best done as described for "pressed screeds" (Chapter VI.). In laying large surfaces it is best to arrange the screeds, so that the work can be laid in alternate sections or bays, which will afford greater facility to get at the work, and also to allow the isolated bays to expand. For instance, if laying a stretch of street paving 50 feet long and 6 feet wide, this would be laid out in ten 5-foot bays, the screed rules, each 6 feet long, being laid so as to form the odd numbered bays to be laid and finished first. This allows the workmen more freedom by standing on the empty bays when finishing the laid bay. The screeds are then removed, and the intermediate bays laid, the sides of the finished bays serving as screed or bearing when ruling in. Boards or bags are laid on the finished bays to protect the surface, and give a footing for a workman to finish off the intermediate spaces. It must not be forgotten to fix the screed rules with the necessary fall towards the kerb, also to keep the ends of the screed about $\frac{3}{4}$ inch above the kerb, to allow for any subsidence, and for water to run off. This also provides for the greater amount of wear that takes place near to than actually on the kerb. The foundations should be thoroughly saturated with water before the screeds are fixed. If this is not done, the brick or other dry material used will absorb the moisture or life from the concrete, and render it

dry or dead. The drenching with water also frees the broken materials from the dust caused by breaking the large pieces *in situ*. In laying paving on a gauged foundation, the surface should be well swept with a hard broom and afterwards damped, so as to ensure the perfect cohesion and solidity of the foundation and the paving. The kerbs and channels are sometimes made *in situ*, but more often they are cast and laid in the same manner as ordinary stone. Cast work is harder than laid work; it also allows the paving to be laid with greater freedom. Illustration No. 188 shows sections of street kerbing and channel which may be used in connection with slab paving, or pavements laid *in situ*.

LAYING CONCRETE PAVEMENTS.—The foundations having been damped, and the rough stuff gauged, it is carried in pails and emptied at the top end of the bay. The plasterer spreads it with a laying float, and rams it well into the foundation. When he has laid a stretch the whole width of the bay, and as far as he can conveniently reach, he moves back and lays the remaining portions of the bay in the same way until complete. The rough stuff surface is then made fair, but not smooth, with the gauge rule. The remainder of the bays are dealt with in rotation. The fine aggregate is then gauged, and laid and spread until flush with the screeds. The stuff should be rather above than below the screeds, to allow for subsidence by subsequent ramming, ruling, and patting. All concrete bodies over 2 inches thick should be deposited in layers. Each layer should be well rammed with an iron punner, or a hardwood punner bound with iron. Concrete gains strength by compression, and consequently its density, imperviousness, and durability is increased. Even for 2-inch pavements better results are obtained if the stuff is deposited in two layers, each layer well beaten with an iron hand-float. If only 1½ inches thick, it should be consolidated by being beaten with an iron float. The surface is next ruled with a floating rule. The rule is worked square on edge, and the concrete cut and beaten in successive short and quick strokes. If the stuff is soft and laid too full, the rule is worked loosely on edge with a zigzag motion, so as to draw the excess stuff and water off the surface, and leave the body full and regular. If there are any hollow places, they are filled up with stuff, and the rule again applied. In all cases the surface should be finally straightened by beating with the rule. This process leaves the surface more uniform, straight, and solid than by dragging or working the rule.

TROWELLING CONCRETE—After being ruled, and when slightly firm, the surface is beaten with a wood hand-float, which lays any irregular parts or projecting pieces of aggregate. The beating or patting is continued until the "fat" appears on the surface. It is then trowelled, or rather ironed, the trowel being worked on the flat of the blade with a circular motion. The plasterer, when trowelling off, should have a hand-float in the other hand to lean on when reaching to a far-off part. The float is also useful to pat any dry parts. The surface must be finished with a semi-dry stock-brush to obtain a uniform grain. A vast amount of care is required in trowelling off. Perfection can only be attained by practice, and a close observation of the materials, conditions, and the state of the atmosphere during the progress of the work. The best effects can only be attained by acquiring a knack of working the trowel on the flat, and by knowing when to begin and when to leave off. It is a waste of time, and the cause of an unequal surface, if the trowelling is begun before the stuff is firm; but time and labour will also be lost if the trowelling is left until the stuff

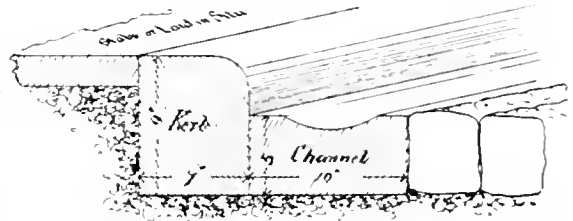

NO. 188.—SECTIONS OF CONCRETE KERB, CHANNEL, AND PAVING.

is too stiff, or has nearly set, for then the surface will be rough and patchy. In either instance the surface is more or less spoiled, and the ultimate appearance and hardness seriously affected.

GROUTING.—The use of neat cement for trowelling off should not be resorted to (this is termed "grouting"), and is used when the surface is left till set, or when it has not been properly patted and trowelled. The expansion of a strong and weak gauge being unequal, the result is that the surface peels, or should it adhere, it is patchy and discoloured. Where grouting is unavoidable, the cement should be gauged with an equal part of fine aggregate, the aggregate being the same as used for the topping.

DUSTING.—Another bad process is that of sprinkling dry neat cement over a soft surface (this is termed "dusting"), and is used to absorb the moisture caused by sloppy gauging. It has drawbacks similar to grouting. If unavoidable, the cement should be mixed with fine dry aggregate in the same proportion as the topping. If the stuff were trowelled at the correct time, there would be no necessity for grouting; and if properly gauged, no need for dusting. No concrete surface can be made so solid and hard as when it is finished in one body and at one time.

TEMPERATURE.—It is well known that extreme heat and cold affect the expansion and contraction of iron. These extremes have a similar effect on concrete, especially during the process of setting and hardening. Equality of temperature during setting is desirable. Cold and humid atmosphere retards setting; hot humidity accelerates it. Concrete laid in cold weather stands better than that laid during heat. Concrete laid in mild damp weather is better than in either extremes. During high temperatures, the surface, when sufficiently hard, should be covered with damp deal sawdust, old sacks, mats, or sailcloth, and saturated at intervals with water. If the sun's rays are hot, the surface of the work while in progress should be protected by extending tarpaulin or old sail-cloths above the parts being laid. Concrete surfaces are further hardened by flooding with water, or where this is not practical, covering with wet sawdust or sand as soon as set. Care must be taken that the sawdust is clean and of a light colour, as otherwise it will stain the work.

NON-SLIPPERY PAVEMENTS.—Concrete pavements for special purposes are rendered non-slippery by mixing $\frac{1}{2}$ -inch lead cubes with the topping stuff. Lead cubes about $\frac{1}{2}$ inch square, laid by hand from 1 inch to 4 inches apart in the moist concrete surface, have been used for rendering concrete surfaces non-slippery. Iron and brass filings are also used for the same purpose, and also for increasing the wear-resisting power of concrete surfaces. Roughened, indented, grooved, and matted surfaces are also used to obtain a better foothold on concrete surfaces.

GROOVED AND ROUGHENED SURFACES.—Stables, yards, &c., are grooved and channelled on the surfaces to prevent animals from slipping, and also to carry off urine or other liquids to the traps or gulleys. Indented surfaces are useful on steep gradients to give a better foothold. Grooves are made with a special wood or iron tool, which is beaten into the surface as soon as the concrete is floated. The grooves, for stables, are generally made about 5 inches from centre to centre, and the depth about $\frac{3}{4}$ inch. A line is first made at one end of the work, and the groover is then laid on this line, and beaten down with a hammer to the desired depth. Before it is taken off, a parallel rule is laid on the surface and against the groover, which is then taken up and laid close to the other side of the parallel rule, and beaten in as before, and so on until the whole surface is done. The width of the parallel rule is equal to the desired width between the grooves, less the width of the groover. Grooves, however long, can be made by moving the tool along, and against a long parallel rule. After a stretch of grooves have been sunk, the surface is trowelled, and the inden-

tations made true. It may be necessary to apply the groover again, and beat or work it forward and backward to further regulate their depth and straightness. They are then made smooth with a gauging trowel and finished with a damp brush, the sides of the grooves being left smooth to give a free passage for liquids.

Grooves on a surface having a fall should radiate toward the deepest point. A level surface may be made to carry off water by the indentations being formed wider and deeper towards the outlet. Street and other pavements are sometimes indented with metal rollers to give a better foothold. Platforms and other surfaces are sometimes made rough or indented by beating the moist concrete with a "stamping-float." This tool is about the same size and shape as an ordinary hand-float. The sole has a series of squares projecting about $\frac{3}{4}$ inch, each square about 1 inch, and $\frac{1}{2}$ inch apart. Concrete surfaces are also roughened or matted by dabbing the surface as soon as trowelled with a coarse stiff whalebone brush. Illustration No. 189 shows three designs of grooved surfaces for carriage drives, conservatories, &c. Figs. 1 and 3 were introduced by Mr Philip Hobbs, the managing director for W. B. Wilkinson & Co. Fig. 2 is known as the herring-bone pattern. A plain border, or one with a single width of the main design, is generally formed on the sides and ends of the floor. A rough matted surface may also be obtained by pressing or beating a wet coarse sack or matting over the moist concrete.

STAMPED CONCRETE.—Various materials and methods are used for stamping or indenting concrete surfaces to obtain a better foothold, or to form any desired pattern. Iron stamps are generally used, but owing to their weight and rigid nature, are unsuitable for large sections.

Plaster stamps are sometimes used for temporary purposes, or for small sections and quantities. Stamps for large concrete surfaces should be composed of a material that is easily made to the desired form, durable, and slightly flexible. For this purpose I used wood, also gutta-percha, for stamping the concrete paving in the streets of Old London at the Health Exhibition, 1884. The side walks were imitation red bricks, with a herring-bone design. The design was indented with a wood stamp 3 feet long and 2 feet wide. The ground of the stamp was formed with $\frac{1}{2}$ -inch pine boards, held together with ledges on the back, the design being formed on the other side with projecting hardwood fillets to form the brick joints. The pavement topping was composed of fine Eureka concrete, coloured red, and laid 1 inch thick on a rough concrete foundation. After the surface was lightly trowelled, the stamp was laid on and pressed down by means of a man's weight. The stamp was then taken off, and laid to intersect with the previous joint, the process being repeated until the whole surface was indented. For the roadway, natural coloured concrete was used, stamped in imitation of the old-fashioned cobble stones. A plaster model about 4 feet square was made, the stones being kept very irregular in size and form. From this model a gutta-percha

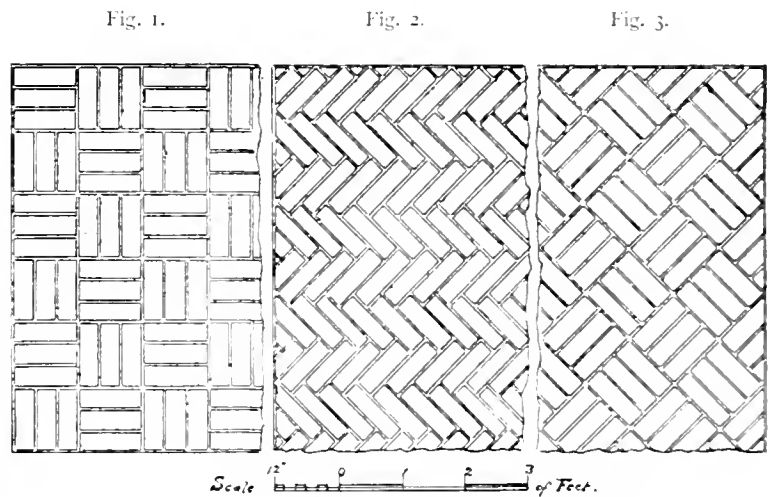

NO. 189.—THREE EXAMPLES OF GROOVED SURFACES.

mould was taken, and the impression on the soft concrete obtained by stamping as before. T. Galloway was foreman on this work. The Portland cement was supplied by Messrs Hilton, Anderson, & Brooks. A most unusual method was employed for forming a rough surface on the granite concrete platforms at York Railway Station. The work was done by Messrs Wilkinson & Co. in 1890. It was laid in bays about 12 feet square. The topping was laid full, but the surface was neither beaten with a float, nor even trowelled, but simply ruled fair by gently tapping with a straight-edge, so as to leave a series of small ridges about $\frac{3}{8}$ inch deep, $\frac{3}{4}$ inch wide, and about $\frac{1}{2}$ inch apart. As there was no compression or consolidation by beating or trowelling the surface, the edges of the ridges if not the whole surface must soon wear, and become ragged. It is probable that the contractors were working to a specification, as from their long practical knowledge of concrete paving, they would not be likely to adopt this method of their own accord.

EXPANSION JOINTS.—Compressive or flexible joints are used to allow for any expansion or contraction that may take place in a large area of concrete paving exposed to atmospheric changes. There are various methods in use for the purpose. The first is to set out the area in small sections, and to lay them in alternate or isolated bays, thus giving time for their expansion before the intermediate bays are laid. This method, by dividing the area into small sections, is the best for preventing cracks, because small sections are stronger than large ones; and in the event of any subsidence in the foundation, the surface fissures are limited to the immediate joints of the sections. Contraction and expansion are also less in small bodies than in larger ones. A good example of this method can be seen on the platforms of the railway station at Rugby, executed by the Imperial Stone Company. There are about 8,000 yards superficial, laid out in sections, each about 1 yard square. The work is 2 inches thick, and laid on a bed of sand. The latter rests on a rough concrete foundation. The sides of the first laid sections were oiled before the next was laid, so as to allow of any section (with the aid of the sand bed) to be taken up, if required, for repairing gas or water pipes, &c. Compressive joints are formed by laying strips of wood, paper, felt, lead, or rubber along the sides of the first laid bays. The strips are made the same width as the thickness of the paving, and are laid flush with the edges of the paving. Wood strips about $\frac{1}{8}$ inch thick, left rough from the saw, are generally used. The changes of temperature produce opposite effects on the wood and concrete. For general purposes strips are not necessary for grooved work, as the grooving to a certain degree forms the surface into sections, or a series of blocks, which have a tendency to counteract cracks. Where the foundations are weak, the resultant cracks in grooved work generally settle or form at the deep parts of the grooves, and are often scarcely noticeable to the eye.

Another method of forming joints is by cutting with a wide chisel or a cutting tool before the rough concrete is set, a corresponding joint being cut in the fine concrete topping. False joints are made by indenting the topping after it is trowelled. A metal roller is used for finishing true joints and forming false joints. Frames strong enough to resist the expansion of the concrete would not only increase the density and strength of concrete paving and blocks, but also effectually prevent its cracking.

Another method for forming sections in large surfaces of pavement or floors to prevent cracks is effected thus:—First set out the size of proposed sections on the rough or first coat, then with a straight-edge, a wide chisel, or a cutting tool and a hammer, cut through the rough coat, so as to divide it into sections as set out. This done, insert wood strips into the cuttings, keeping their top edges about $\frac{1}{8}$ inch below the screeds or rules which represent the finished surface. The strips are made from $\frac{3}{4}$ inch to $1\frac{3}{4}$ inches wide, $\frac{3}{16}$ inch thick, and in suitable lengths. The width is regulated

according to the thickness of the paving. For instance, for 2-inch paving the widths should be $1\frac{1}{4}$ inches. This allows about $\frac{1}{2}$ inch in the rough coat (with $\frac{1}{4}$ inch play from the bottom), and about $\frac{1}{8}$ inch in the topping, and $\frac{1}{4}$ inch for the upper thickness of the topping to cover the top edges of the strips. After the strips are inserted the rough coat is beaten up or made good to the sides of the strips, and then the topping is laid and trowelled in the usual way. The surface joints are then made directly over the strips, with the aid of a straight-edge, so as to form a clean and sharp joint. As already mentioned, these strips allow for any subsequent contraction or expansion, thus avoiding zigzag cracks; and in the event of repairs, or taking up for repairs to underneath pipes, each section can be cut out and relaid separately without injury to the adjoining sections. This process of inserting strips in the rough coat, cutting nearly through the topping, gives the same results as if the strips were laid flush with the surface of the topping, with the advantages that the surface can be more readily trowelled, and is more pleasing to the eye, because the strips are not seen. A cutting tool is a blade of steel about 5 or 6 inches long and 4 inches wide, with a wood handle at one end. The section of the blade is well tapered, so as to obtain a sharp cutting edge, and form a wide top edge to offer a broad surface for the hammer while being beaten.

WASHING YARDS.—Eureka concrete being of a hard nature, and having a close and smooth surface, is well adapted as a flooring for all washing or cleaning purposes. The surface being smooth, it can in turn be readily cleaned. Illustration 190 shows the half plan of washing yard with the plan and section of grooving, and the fall for a yard for washing carriages, &c.

STABLE PAVEMENTS.—The paving for stables, and other places for keeping animals, should be jointless, non-absorbent, hard, and durable. Such paving must not be slippery, yet smooth enough to be easily washed, the whole laid to falls, and grooved to give an easy and ready passage for liquid manure and water when being washed. No material can so fully meet these requirements as a well-made and well-laid concrete. Granite setts are hard, but slippery. Bricks are too absorbent; the urine percolates between the joints and generates ammonia and other effluvia which are detrimental to the health of animals. The following is an extract from Report by Dr Ballard, of the Local Government Board, Whitehall, London, S.W., 1892, in an Inquiry as to Effluvium Nuisances:—

“The flooring of the stable should be of such materials and so laid as to permit the ready flowing away of the liquid manure from the standing of the animal. For this purpose the flooring should be as even and uniform as possible, and such as is incapable of absorbing urine or other liquids that may fall upon it. Hence the best flooring theoretically is one which is jointless, firm, and properly sloped to a proper channel. The worst sort of paving that I have seen in ordinary use is that made with round pebbles laid upon the unprepared ground. Brick is too absorbent to make a good pavement; square stone setts, and what are termed ironstone bricks, laid upon a duly prepared foundation of cement, are better, but even these are not equal as a flooring to a hard cement. The flooring of a slaughter-house should be of some uniform material, sufficiently even to be capable of ready and thorough cleansing with water and a brush, and sufficiently rough to avoid slipping on it. At the same time it should be firm, and incapable of giving way under the fall of

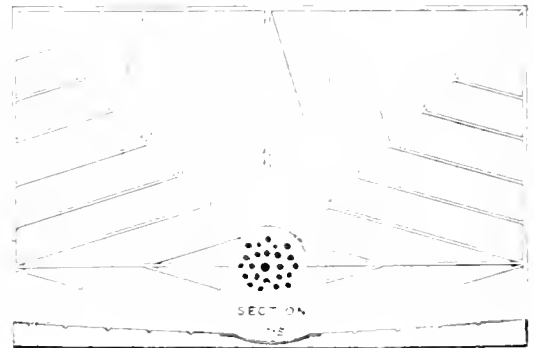

NO. 190.—HALF PLAN OF COACH YARD, WITH SECTION THROUGH CENTRE.

beasts, or of breaking under rough usage. Paving with York flagstones set with cement is the paving most commonly met with both in London and in the country; but the objections to it are its slipperiness when blood and other matter from the animals slaughtered become spilt upon it, the tendency there is to the cracking and loosening of the stones (when blood or other liquids may percolate between them and through the cracks), and the frequent loosening and breaking away of the cement with which they are set. The best paving of all is an even, jointless paving sufficiently

hard and firm to resist rough usage, and sufficiently rough not to be slippery. For example, I recently saw at Newcastle-on-Tyne seventeen slaughter-houses forming an abattoir, constructed in 1869 by a private company, and which have been in use ever since for the slaughter of horned cattle and sheep. The flooring of these and of the approaches to them is made of cement, laid by W. B. Wilkinson & Co., of Newcastle. It had worn admirably, was free from slipperiness, and had not cracked anywhere. It was readily cleaned, and was as perfect a flooring for a slaughter-house as could be devised. The butchers using the slaughter-house spoke of it in the highest terms of commendation. Ordinary asphalt is unfit for use in slaughter-houses; it is too soft in summer, and readily yields to blows or pressure. It has been a failure wherever I have seen it laid down."

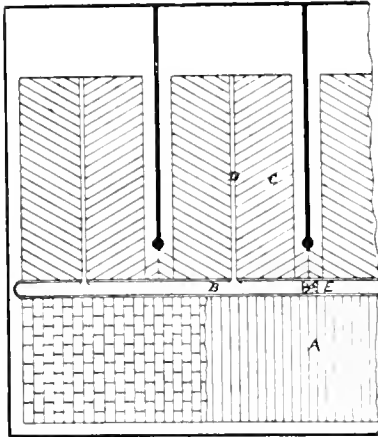

NO. 191.—PLAN OF STABLE FLOOR.

Illustration No. 191 shows the method of grooving stalls and gangways. A is the gangway, which can be coloured red or buff if desired. Two designs of grooving are shown. B is the main channel; E is a stable pot; C is the side or diagonal groove; D is the centre groove. A plain margin is left around each stall to permit of easy cleansing. The blocks in the gangway formed by the cross grooving are 10 inches by 5 inches. Cross grooving affords a foothold both front and sideways. This method is well adapted for crossings and gateways, as it affords a foothold for pedestrians crossing, as well as for horses. For cross grooving, make the long grooves first and the cross grooves afterwards.

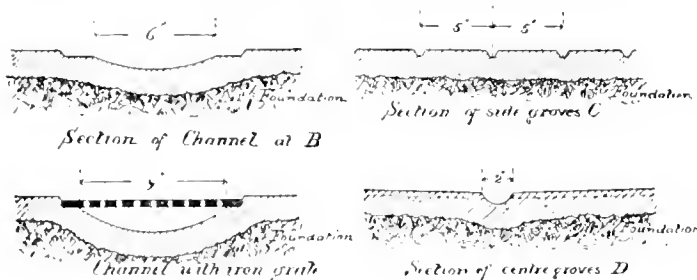

NO. 192.—SECTIONS OF THE VARIOUS PARTS OF THE STABLE FLOORS SHOWN ON ILLUSTRATION NO. 191.

screed rules, which also act as screeds to work from. Channels are generally formed after the other surface is finished. Sometimes templates are fixed on the bed of the channels, and the space filled in and ruled off with a straight-edge while the whole surface is being formed. The thickness of stable paving varies from 2 to 3½ inches, according to the class of horse. The thickness of the stalls is often decreased towards the manger. Fine examples of grooved work are to be seen at the Windsor Brewery, executed by G. Morris, the foreman of the concrete layers.

Illustration No. 192 shows the sections of the various parts of above diagram. Stables are generally laid with a fall toward the main channel. The amount of fall varies according to ideas of the horse owners. The fall adopted by the War Office is 1 in 80 from the top of the manger to the main channel, and 1 in 36 from each side of the stall to the centre groove. The width of the main channels is usually set out with

BREWERY PAVEMENTS.—The paving of brewery floors requires not only to be hard, but must resist the action of beer and yeast. Great care must be taken that the concrete is thoroughly set and dry before contact with beer takes place. The floor for mash-tun, hop-rooms, fermenting backs, cooling backs, tun-room, &c., should have the topping strongly gauged to stand the effects of beer, and the heavy wear caused by rolling barrels, especially when moved on their edges. Two parts of Portland cement to 3 of fine aggregate is the usual gauge. A further protection against the action of beer is obtained by coating the surface with acid-proof solution as given in the Appendix. Fermenting and cooling backs, also stillions, malshouses, and granary floors, are best constructed *in situ*. They are generally formed with a structural thickness of coarse concrete, and the upper surface laid with Eureka concrete. These floors are not only fireproof, but are also impervious to moisture, acid, and vermin. Fine examples of brewery floors are to be seen at Man, Crossman, & Paulin's Breweries, London. David Nicols was the foreman concreter, and the cement was supplied by Messrs Francis & Co., Nine Elms, London.

DAIRY AND FOOD FACTORY PAVEMENTS.—Fine concrete is undoubtedly the most suitable material for forming floors, table tops, shelves, and tanks in dairies and food factories, &c. Owing to the hard and impervious nature of concrete it is absolutely sanitary, and easily made with a dense and smooth surface. It can be washed as readily and as clean as china or glazed earthenware. Tanks and table tops, however large, can be made in one piece, as also floors, thus avoiding joints, which are unavoidable with other materials. It is a well-known fact that any material which is porous or jointed affords a harbour for damp, dust, and microbes. No such defects, however, are to be found in well-made and well-laid fine concrete. Many of the principal dairies, sweets and potted meat factories in London and the provinces are paved, and have their working surfaces formed with fine concrete. The paving for this class of work is best laid as described for Eureka paving, and the table tops and tanks as for benches and tanks. An extensive and excellent example of this class of work can be seen at Barratt's Factory, Wood Green, N. This work was executed by the Patent Paving Company, and Frank Jay was the foreman of the concrete layers. Another important example is that of B. Harris's Bacon Factory, at Calne, Wilts, executed by Messrs Homan & Rogers. Walter James was the foreman of the concrete work. Numerous extensive works of this class have been executed by Messrs W. B. Wilkinson & Co., the Imperial Stone Company, B. Ward & Co., and other firms of note.

STAFFORDSHIRE STONE PAVING.—This paving is the invention of F. B. Wrightson and W. Metcalfe, who obtained a patent for this material in 1895. According to the specification, it is composed of Portland cement and schariff, which are chemically combined so as to produce a hard and impervious substance. Judging from the samples and tests, this paving is exceedingly hard and impervious. Owing to the great variety of colours to be found in the aggregate used in this material, it is well adapted for the formation of mosaic paving.

PETRURA PAVING.—This is the latest invention in patent paving, being patented in 1896 by W. Millar and O. J. Owen. This paving combines all the hardness and impermeability which are obtained by the use of the aggregates commonly employed in the various patent pavings of the past, such as granite, slag, stone, &c. In addition to the qualities of hardness and imperviousness, it has the great advantage of being non-slippery. This is an important feature, being one which is the only objection to most of the patent pavings of the past. It is also practically noiseless, thus forming a perfect paving. Being chiefly composed of a waste or by-product, it can be sold at a comparatively low price. Combining the minimum of cost with the maximum of quality, it will doubtless be a welcome addition to the present-day pavings.

SUMMARY OF PAVING "IN SITU."—Having now described the various materials, parts, and processes of paving, the whole may be summarised as follows:—1. Setting out the levels and falls. 2. Preparing the bottom. 3. Laying and wetting the foundation. 4. Laying the screeds to the desired levels and falls. 5. Gauging and laying the materials. 6. Ruling, patting, and trowelling the surface, and also grooving, indenting, or matting, if required. 7. Protecting and wetting the work until thoroughly set and hard.

CONCRETE SLABS.—Concrete slabs are now extensively used in London and the provinces by borough surveyors for street paving. The Victoria Stone Company were the earliest manufacturers of concrete paving slabs. Concrete slabs have now been in use for twenty-five years. Upwards of 300 miles of footpaths average 7 feet wide have been laid with Victoria stone. This artificial stone was laid on London Bridge, where the foot traffic exceeds 126,000 passengers per day. This paving has been laid about six years, during which time many millions of passengers have walked over it, and yet the wear is so small that it is scarcely measurable. Another portion of the bridge has been laid with Victoria paving upwards of twenty years, and although subjected to enormous traffic, the wear is hardly perceptible. The following table shows the relative strength of concrete stone compared with that of various kinds of stone and brick, as per Kirkcaldy's certificate, 1887:—

TABLE XII.—CRUSHING WEIGHT PER CUBIC INCH IN LBS.

Medway Gault Brick	940	Fireclay Brick	4,032
Bath Limestone	1,244	Stafford Blue Brick	4,032
Portland Stone, against the bed	2,426	Bramely Fall, on the bed	5,135
Portland Stone, on the bed	2,620	Yorkshire Landing, on the bed	5,616
Medway Gault Brick (pressed)	2,643	Yorkshire Landing, against the bed	5,851
Bramely Fall, against the bed	2,934	Granite, Peterhead	6,216
Craikleith Stone	3,110	Patent Victoria Stone	8,321

The tensile strain of Patent Victoria Stone has now reached 1,150 lbs. per square inch. The following table shows the absorptive qualities of various stones, as given by the Committee of Council on Education, South Kensington:—

TABLE XIII.—BULK OF WATER ABSORBED WITH BULK OF STONE PER CENT., TWENTY-FOUR HOURS.

Bath Box, ground	17.0 per cent.
Portland, very durable	13.5 "
Mansfield, moderately durable	10.4 "
Craikleith, very durable	8.0 "
Patent Victoria Stone	7.6 "

It will be seen by the above tables that this kind of artificial stone for strength is superior to most natural stones. It also has less absorbent properties, and consequently is less liable to laminate under severe frost through expansion of the moisture in freezing. There are several other firms who are now manufacturing concrete paving slabs. There are also a few corporations who make their own slabs. Slabs are made in various lengths and thicknesses, but generally in one width. The ordinary sizes for paving slabs are as given in the following table:—

TABLE XIV.—SIZES OF PAVING SLABS.

2 feet by 2 feet	} 2 inches thick.	2 feet 6 inches by 2 feet	} 3 inches thick.
2 feet 6 inches by 2 feet		3 feet by 2 feet	
3 feet by 2 feet		3 feet 6 inches by 2 feet	
3 feet 6 inches by 2 feet		4 feet by 2 feet	

The most useful length is 2 feet 6 inches. They can be cut with a chisel as easy as cutting York stone. Special slabs can be made for circular work, also with rebated sinking for metal plates, to cover coal-holes, drains, gas and water taps, &c. Concrete paving slabs are laid in precisely the same way as natural stone.

CONCRETE SLAB MOULDS.—Slab moulds are made with 1½-inch boards ledged together. On this ground, wood sides and ends (each being 2½ inches by 2 inches, or 3 inches by 3 inches according to the desired thickness of slab) are fixed. One side and end is held in position with thumb-screws, which fit into iron sockets, so that they can be unscrewed to relieve the slab when set. The bottom and the sides and ends are lined with strong iron or zinc plates.

Name-plates for concrete slab moulds and fibrous plaster slab moulds, also hand stamps for forming names in concrete paving, are manufactured by A. Gilchrist, of Glasgow.

SLAB MAKING.—Slabs are mostly made by machinery. The materials are 1 part of Portland cement mixed dry with 2½ parts of crushed granite and slag in equal proportions that have been washed and passed through a ¼-inch sieve. They are thoroughly incorporated together in a horizontal cylinder worked by machinery, a minimum of water being added, and the mixing continued until the mass is well gauged. The mould, which has been previously oiled, is placed on a shaking machine, known as a "trembler" or "ditherer," which gives a rapid vertical jolting motion to the mould and its contents. A small portion of "slip," *i.e.*, neat cement, is laid round the angles. The machine is then started, and the concrete laid on the mould by small shovelfuls at a time, a man with a trowel spreading it over the mould until full. The surface is then ruled off. If both sides of the slabs are required for use, the upper surface is trowelled. The whole operation of mixing, filling in, and ruling off takes about seven minutes. The filled moulds are removed and allowed to stand for about three days. The slabs are then taken out, and stacked on edge and air-dried for about five days. They are then immersed in a silicate bath for about seven days, and are afterwards taken out and stacked in the open air until required for use. They should not be used until three months old. Paving slabs are also made by hand, by ramming and beating the moist concrete into the mould with an iron hand-float. Powerful ramming, trituration, or violent agitation of the gauged materials in the mould, tend to consolidate concrete, and it is possible to further increase its homogeneity by the use of hydraulic pressure. The above is the method that I used when manager for the Wilkes' Patent Flooring and Eureka Concrete Company. There are a large number of slabs which are not immersed in a silicate bath, but are simply immersed in clean water. The Victoria stone slabs are all hand made. The Imperial Stone Company make their concrete paving slabs by machinery. They are dense and hard, and impervious to moisture. This Company also lay paving *in situ*.

INDURATING CONCRETE SLABS.—The surface of concrete slabs or other work exposed to frictional wear may be hardened by soaking in a silicate solution. Silicate of soda has a great affinity for the materials of which concrete is composed, and by induration causes the surface to become hard, dense, and non-porous.

The silicate of soda and potash is known as soluble glass or dissolved flint. The soluble silicate is a clear viscous substance, made from pure flint and caustic soda, which is digested by heat under pressure in Papin's digester. Its strength is technically known as 140 Twaddle, which shows 1,700 on a hygrometer. When used as a bath for concrete, it is diluted with water, the proportion varying from 6 to 10 parts of water to 1 of silicate. Concrete pavements, laid *in situ*, may also be hardened by washing with silicate solution. They should not be silicated until two days after being laid, to allow the moisture to evaporate and the silicate to penetrate.

MOSAICS. The art of making mosaic is at the present time scarcely within the province of plasterers, but in former times many kinds were made *in situ* or in slabs by plasterers. The subdivision of labour has to a great extent caused mosaic making to be confined to specialists. Concrete mosaic is still made by plasterers. A brief description of this and other kinds may prove useful as well as interesting, especially to plasterers who are in the habit of fixing tiles and working in concrete. Mosaic is the art of producing geometrical, floral, or figure designs, by the joining together of hard stones, marbles, earthenware, glass, or artificial stone, either naturally or artificially coloured. The term "mosaic" embraces a wide range of artistic processes and materials for the decoration of floors, walls, and ceilings. The Egyptians were experts in mosaic. The Cairo worker as a rule had no drawings made beforehand, but the mosaic design was constructed by the artist as he arranged the pieces on the ground. The mosaic pavements of Cairo are of a slightly different character from those used for wall decoration, and are generally composed entirely of marble tesserae and sometimes red earthenware, of larger size than the delicate pieces that are included in wall mosaics. They are arranged to form geometrical patterns within a space of about 2 feet square. Each square or slab is made separately, and the pieces are set, not in plaster, but in a composition of lime and clay impervious to water. The clay must be unburnt, just as it comes from the pit. Mosaic slabs for walls and pavements from Egypt are to be seen in the South Kensington Museum. Saracenic mosaic in Egypt is a combination of the tessellated method with a large proportion of sectile mosaic. The Romans also were great workers in mosaic. The mosaics of Byzantium and Ravenna consisted of cubes of opaque and coloured glass.

In the Museum of Practical Geology there are fragments of old Roman mosaic pavements of the time of the Republic, also tools used by the workers in Roman mosaic, and the stucco which, when mixed with linseed oil, forms the cement for fixing the tesserae. There are also loose tesserae from Jerusalem, Pompeii, Algeria, and Greece. Very fine examples of Greek and Roman mosaic are in the British Museum, and in the Guildhall are exceedingly interesting Romano-British mosaics found in London.

The general method used in England for pavement mosaic is as follows:—The repeated design is traced on stout paper, and small pieces of marble, or more often tile, are gummed on the paper, following the design of form and colour, one piece at a time (with the smooth face downwards) being laid until the design is completed. The mosaic slabs, which are thus temporarily kept in position, are sent to the building and laid where intended. A rough concrete foundation, which has previously been laid level, is then floated with Portland or Keen's cement, and the slabs with the paper upwards are then bedded and beaten and pressed with a hand-float into position. The paper is then damped and drawn off, and any openings or defects filled up with small pieces of the same form and colour as the design. The slabs are made in various sizes according to the design; for instance, a border 12 inches wide may be made from 3 to 6 feet long. When laying the slabs, it is best to begin at the centre and work outwards, and any excess or deficiency taken off or made up in the plain part of the border at the walls. The tiles are made at pottery works in the required sizes and colours. The thickness is generally about $\frac{1}{4}$ inch, and the average surface size about $\frac{1}{2}$ inch. Females are often employed fixing the pieces on the paper. Designs of coats of arms, monograms, dates, figures, flowers, and foliage are effectively produced by this simple and cheap process.

CONCRETE MOSAIC.—All mosaics are more or less of a concretionary nature, and the trade term of "concrete mosaic" is due to the fact that the matrix used is Portland or other cement gauged with the marble aggregate, and laid in most cases in a similar manner as ordinary concrete.

Concrete mosaic is extensively used for paving halls, corridors, conservatories, terraces, &c. It is also used for constructing steps, landings, baths, pedestals, &c. A. C. Hobman, of London, was one of the early pioneers of the manufacture of concrete mosaic, and his mosaic has been extensively used. It is remarkable for beauty and variety of design, durability and perfect polish. Drake, of London, brought concrete mosaic to great perfection. Messrs Williams Bros. & Co., of London, are noted for their artistic mosaic. I have made a large quantity of concrete mosaic for pavements, steps, landings, balustrades, mouldings, vases, figures, and many other purposes in connection with decoration and buildings, and also made imitations of red and grey granite. Slabs and tiles made of this class of mosaic for paving purposes are slowly but surely proving a formidable rival to Italian mosaic and encaustic tiles. It can be made in larger sections, thus facilitating rapidity of laying. It is more accurate in form, durable, non-slippery, and cheaper. The last reason alone is a favourable item in this keen age of competition. Where marble has been scarce, broken tiles, pottery, coloured glass, flints, white spar, &c., have been used as an aggregate. If the marble chips are obtainable as a waste, and near the place of manufacture, the primary cost is small. If the moulds are of metal, and made in sections so as to form a series of moulds in one case, and the casts are pressed by means of hydraulic power, the cost of production is reduced to a minimum. If the casts are polished in large numbers by machinery on a revolving table, the total cost is further reduced. For local purposes they can be made by hand at a medium cost. Slabs are made in almost any size, but generally from 4 to 6 feet superficial. The thickness varies from 1 to 1½ inches. Tiles are usually made about 10 inches square and 1 inch thick. The tiles are generally made with a face of cement and white marble, or white and black marble chippings. They are backed up with a cheaper aggregate. Various tints of the face matrix are obtained by mixing the cement with metallic oxides. The tiles are made in wood or metal moulds, with metal strips to form the divisions of form and colour in the design. If the design is fret pattern, the gauged material is put in between the strips that form the band of the fret. When the stuff is nearly set, the strips are taken out, and the other part filled in with another colour. Sometimes the bands or running design are cast in a separate mould, and when set, placed in position in a larger mould, and the ground filled in, covering and binding the whole in one tile. Another plan is to lay a thin coat of cement on the face of the mould, forming the design with small marble chips by hand, by pressing the marble into the cement as desired. When it is firm, it is backed up with the ordinary stuff, and when set, they are ground and polished.

CONCRETE MOSAIC LAID "IN SITU."—Pavements for halls, passages, shops, landings, &c., are also done *in situ*. A rough concrete foundation is first laid fair to falls and levels within ½ inch of the finished surface line. This ½ inch space is to receive the plastic marble mosaic. The main or centre part is generally done first, and the border last. This allows a walking space or a bearing for boards, laid from side to side, to work on when laying the centre. A plank sufficiently strong to keep one or two cross boards from touching the work is laid along each side. On the side planks the cross boards are laid, and moved about where required. The width of the border is marked on the floor, and wood screed rules laid level to the marks to form a fair joint line for the border, also as a screed when floating the centre part. The screed rules are generally fixed with gauged plaster which is quicker than fixing on gauged cement. After the centre is laid, the plaster should be carefully swept off, and the concrete well wetted before the border is laid. The marble and cement is gauged in the proportion of 2 of marble to 1 of cement, and laid flush with the screeds, laying and beating it in position with a long wood hand-float. The surface is ruled in from screed to screed

with a straight-edge. The surface is then ironed with a laying trowel until it is smooth and fair. If the marble does not show, or is not regular, or is insufficient, the bare parts are filled in with marble by hand. When marble is scarce, the $\frac{1}{2}$ inch of the top surface is laid in two coats, the first coat being composed of cement and a cheaper aggregate, such as broken stone, tiles, &c., and gauged in the same proportion as the upper or marble coat. It is laid about $\frac{1}{4}$ inch thick, and when it is firm, but not set, the marble coat is laid as before directed. The first coat saves the marble, and being firm, tends to keep the marble in the upper coat from sinking. The top coat is sometimes sprinkled over with fine marble chips by hand or through a fine sieve, then pressed into the surface and ironed with a laying trowel. Before ironing the surface, care should be taken that the chips are equally distributed, also that their flat surfaces are uppermost, and that the matrix and chips are perfectly solid and free from ridges or holes. After the centre is laid and screeds removed, the border is laid in a similar way. If there are two or more colours or forms in the border, the divisions are formed with narrow screed rules, and arranged so that as many as practicable can be laid at the same time. This allows the various parts to set at one time, and saves waiting for each separate part to set. The screed rules for circular work or angles are formed with strong gauged plaster and then oiled.

The marble chips are either broken by hand or in a stone-breaking machine. The chips vary in size from $\frac{1}{16}$ to $\frac{1}{4}$ inch. The best colours for borders are a black matrix with white marble or spar chips, or a white matrix with black marble chips. The white matrix is obtained by mixing the marble dust (produced when breaking the marble into chips) with a light coloured Portland cement. The centres can be made in various tints, but the most general is a warm red, which is obtained by mixing the cement with red oxide. Cement coloured with red oxide should be laid first, as it is liable to stain other laid parts of a lighter colour. When the centre and border are laid, the floor is left until the whole is perfectly set and hard, and it is then fit to polish. This is done by means of a stone polisher, water and marble dust, or fine slag powder. The stone polisher is a piece of hard stone from 8 to 12 inches square, and about 3 inches thick, into which an iron ring is inserted and secured with lead. A wooden handle from 4 to 6 feet long, with an iron hook at one end, is inserted into the ring, so that the handle is firm on the stone, yet has sufficient play to be moved freely backwards and forwards. The polishing should not be attempted until the stuff is thoroughly set, because the polishing will destroy the face of the cement, and cause a vast amount of extra labour in grinding the surface down until free from holes. Small parts of the gauged stuff should be set aside as tests for determining when the stuff is set. Concrete mosaic, where economy is desirable, will make a strong, durable, and waterproof floor, and an excellent substitute for higher class mosaics.

ROADWAYS.—It is passing strange that in this progressive age, a safer, more expeditious, and less costly plan than the present is not generally adopted for the laying and repairing of pipes, drains, and wires. Several methods have been proposed, and partly carried out, to improve the tedious, vexatious, and costly methods now in use. The patent impervious concrete roadway patented by Mr C. R. Williams, A.M.I.C.E., seems to have many good points for the formation of new roadways. By this patent, passages are constructed beneath the permanent way, along which gas, water, compressed air pipes, telegraph, telephone, and electric wires are laid; beneath this floor arches and concrete tubes are laid for the sewage. The passages are reached by openings covered with movable concrete slabs. By this method the cost and annoyance of digging up and repairing the roads and stopping the traffic whenever pipes, wires, or drains have to be repaired or altered, are obviated.

CHAPTER XIX.

CONCRETE--Continued.

CONCRETE STAIRCASES—CAST CONCRETE STAIRS—TESTS OF STEPS—CONCRETE STAIRS FORMED “IN SITU”—SETTING OUT STAIRS—NOSINGS AND RISERS—FRAMING STAIRCASES—CENTRING FOR LANDINGS AND SOFFITS—WATERPROOF CENTRING—STAIRCASE MATERIALS—FILLING IN STAIRS—FINISHING STAIRS—NON-SLIPPERY STEPS—STRIKING CENTRINGS—CONCRETE AND IRON—SETTING CONCRETE SOFFITS—FIBROUS CONCRETE—POLISHED SOFFITS—CONCRETE STAIRCASES AND FIBROUS PLASTER—DOWEL HOLES—SUMMARY OF STAIRCASES CONSTRUCTED “IN SITU”—CAST STEPS—TREADS AND RISERS—CLOSED OUTER STRINGS—CONCRETE FLOORS—PLASTER FLOORS—JOIST CONCRETE FLOORS—CAMINUS CONCRETE CEMENT—CONCRETE FLOORS AND COFFERED CEILINGS—COMBINED CONCRETE FLOORS AND PANELLED CEILINGS—CONCRETE AND WOOD—CONCRETE SLAB FLOORS—CONSTRUCTION OF SLAB FLOORS—HOLLOW FLOORS—CONCRETE ROOFS—NOTES ON CONCRETE FLOORS, ETC.—CAST CONCRETE—CONCRETE DRESSINGS—MOULDINGS CAST “IN SITU”—MODELLING IN FINE CONCRETE—CONCRETE FOUNTAINS—TANKS, SINKS, GARDEN EDGING, VASES, CHIMNEY-PIECES—COLOURED CONCRETE—FIXING BLOCKS, LINTELS, WALLS, STRONG-ROOMS, AND COFFINS—STONETTE—TILE FIXING—PATENT NON-SLIPPERY STEPS.

CONCRETE STAIRCASES.—A good staircase is one of the essential features in a building. The safety and convenience of persons using a staircase are not only affected by the due proportions and arrangement of the steps, but by the strength and fire-resisting properties of the materials employed, and the manner of construction. The wells are in many cases too small, out of proportion to the structure, which necessitates dangerous winders, tiring high risers, narrow treads, or insufficient headway. Some architects when designing a staircase pay little attention to the practicability of construction. What may seem easy in theory or on paper is often found impracticable or unnecessarily difficult when reduced to actual practice. The errors of commission and omission are left for the workmen to contend with and overcome as best they may at the employer's expense. Happily such cases are few, the majority of architects supplying figured drawings, which are not only a help and guide to the workmen, but also ensure a practical staircase in due proportion and without unnecessary expense. Staircases should be spacious, light, and easy of ascent. It is generally admitted that a 12-inch tread and a 6-inch rise is the most convenient, and that no tread should be less than 8 inches or more than 16 inches, and no rise less than $4\frac{1}{2}$ inches and more than 7 inches. According to Blondel, the rise should be reduced $\frac{1}{2}$ inch for every inch added to the tread, or the tread reduced by 1 inch to every $\frac{1}{2}$ inch added to the riser, taking a 12-inch tread and a 6-inch rise as the standard. Treads may be increased by means of a nosing, which usually projects from 1 inch to $1\frac{1}{2}$ inches. Nosing not only gives more available space for the tread, but also affords some advantage to persons going down stairs, as the heel cannot strike against the rising. In setting out a flight of stairs, the tread of the steps are measured from riser to riser. Where practicable, the number of steps from landing to landing should be odd, because when a person begins to ascend with the right foot first (as most people do) he should end with the same foot. Rectangular steps are called fliers. Winders, being narrowed at one end, are always more inconvenient and dangerous than straight steps, and should not be used for public buildings or other

places where there is a crowded traffic. Winders are also more expensive to construct. The Education Department prohibits winders in schools, and the London County Council follows the same rule. They are, however, unavoidable in circular staircases, also in some instances in angles, where a quarter or half space landing would not give the desired rise. Winders should be so made that the tread 6 inches from the end of the narrow point should be wide enough to step upon without danger of slipping. No stairs should be less than 3 feet from the wall to the hand-rail. A width of 3 feet 6 inches will allow two persons to walk arm-in-arm up or down stairs. A width of 4 feet 6 inches is generally used; this gives plenty of space for two persons to pass each other. No hard and fast rules can be laid down for the size of treads and risers, as they are regulated more or less by the size of the well and the height from floor to floor. Too few steps in a flight are as bad as too many. There should not be less than three. Long straight flights of steps are tiring and dangerous. The straight line of length should be broken by landings, so that there may not be more than eleven continuous steps. Landings give ease in ascending and safety when descending. No landing should be less in length than the width of the staircase. The staircases in pre-Elizabethan England were usually plain, dark, and in long narrow flights; but with the Elizabethan architecture came in a more commodious, light, and decorative style. Wood stairs are often enriched with plaster work, the soffits being panelled with plaster, and the strings adorned with composition or plaster enrichments. Stone stairs are also frequently enriched with plaster mouldings in the angles of the soffits and walls. External steps and landings are usually made with a fall of $\frac{1}{4}$ inch to the foot to allow rain to fall off. The following table of the sizes of external and internal steps of various public and private buildings in London are taken from actual measurement. The dimensions are given in inches. *T* denotes the tread, *R* the rise, and *N* the nosings.

TABLE XV.—SIZES OF STEPS.

EXTERNAL STEPS.				INTERNAL STEPS.				
		T.	R.	N.		T.	R.	N.
St Paul's Cathedral	West Portico	15	5	—	Natural History Museum	14	6	1½
	North Door	14	5¼	—	Grosvenor Gallery	12	6	1½
British Museum		15½	5¼	2	Tivoli Music Hall	12½	7	1¼
Natural History Museum		16½	5½	1½	House, Russell Square	10½	6	1¼
St Martin's Church		13½	4¾		West End House	9	6½	1½
Farringdon Market		14	4½	—	„ „ Attic Stairs	8	7½	1¼
Duke of York Steps		13	5¾	—	Suburban Villa	9	7	1½
House, Bedford Square		10	4¾	1½	Small Houses	8	7	1½

CAST CONCRETE STAIRS.—Concrete is now fast superseding stone, wood, and iron for staircase construction, where strength, durability, economy, and fire-resisting properties are required. Cast concrete stairs were first introduced by Mr W. B. Wilkinson, of Newcastle, nearly sixty years ago, and first used in London by Mr M. Allen in 1862. The stairs were cast in single steps, or in treads and risers, and fixed in the same way as natural stone. Mr Allen used shingle and coke-breeze as aggregates. Square and spandril steps, risers, and treads are cast in wood moulds; circular steps and curtails in plaster moulds. Spandril steps should have the wall or "tail" end formed square,

and about $4\frac{1}{2}$ inches deep, to give a better bed and bond in the wall. A good mixture is 3 parts of granite or slag chippings and 1 of Portland cement, gauged stiff, and well rammed into the moulds. When set, they are removed from the moulds, air dried, and placed in water or a silicate bath, and treated in a similar way to that described for slabs. For long steps, pieces of T iron or iron pipes are sometimes inserted in the centre of the concrete while being cast. The iron is not actually required to strengthen concrete properly made, but is used to give a temporary strength to the cast while it is green, so as to allow more freedom and security in handling the cast when it is being taken from the mould and moved about till permanently fixed. Landings are cast in a similar way, but unless very small, they are best done *in situ*. I have made landings up to 40 feet superficial, but owing to the cost of transit, hoisting, and fixing, they were not profitable.

TESTS OF STEPS.—The following examples show the strength of concrete steps:—In Germany, when constructing a concrete stair, with square steps 3 feet 4 inches long, 14-inch tread, and $6\frac{1}{2}$ -inch rise, and one end set 8 inches into the walls, four steps were submitted for trial, and 5,940 lbs. weight of iron was gradually piled on them. The steps showed no signs of fracture, but no more weight could be put on because the masonry began to yield. The load was left on three days, and the steps remained unaffected. Although numerous tests have been made in England of concrete floors and blocks, few have been made for concrete stairs. The following may be given as a reliable one:—When manager for Wilkes' Metallic Flooring and Eureka Concrete Company, I had several concrete steps tested by Mr D. Kirkcaldy, which gave highly satisfactory results. When constructing staircases with concrete steps at the Parmiter Schools, London, Messrs T. Chatfield Clarke & Son, the architects, required every step to be tested before they were built into the walls. The steps were about 6 feet long, 11-inch tread, and 6-inch rise. Every step was tested in the presence of the clerk of works and P. Storrier, the foreman concreter, and the author. The steps were supported at both ends, and weighted with a distributive load. The majority, which were matured by age, passed the specification standard, while a few, which were green, broke with a load considerably under the standard. A similar step, but fully seasoned with time and water, was exhibited at the Building Trades' Exhibition at the Royal Agricultural Hall, 1887, where it carried a distributed load of 8,832 lbs. without a sign of flaw. Tests of concrete slabs, &c., are given in Table XVI., page 504.

CONCRETE STAIRS FORMED "IN SITU."—Concrete stairs are an outcome of stairs built with cast concrete steps. Stairs formed *in situ* were introduced by the author in 1867, and first used on a small scale on the Redcliffe estate, West Brompton. The idea was suggested by the use of reverse moulds for fibrous plaster work, and in the formation of concrete dormer windows made *in situ* on some of the mansions in Redcliffe Square. The step landings and the wall bond, being a monolithic structure, are to a certain degree self-supporting. They tend to strengthen instead of to weaken the walls. Architects generally supply drawings of the intended staircase, but as there is often a difference in the size of the details of the actual work and the drawings, it is necessary that the workman should have a practical knowledge of setting out the "height" and "go" for the pitch board, to suit the landings and the well of the staircase, and ensure the necessary head-room.

SETTING OUT STAIRS.—A correct method of setting out the framing for concrete stairs is of primary importance. The height of a stair is the length of a perpendicular line drawn from the upper surface of a floor to that of the one immediately above it. The "ingo," or "go," is the length of a horizontal line drawn along the centre line of the flight of steps or stair space. The exact height and widths should be taken on a rod, which should afterwards be used for setting out the work. Never work without this rod, as it is quicker and more accurate than measuring with a

2-foot rule. There are various ways of getting the dimensions of treads and risers. The following is a simple one, and answers for most purposes. The height and go are taken and suitably divided. For example, if the height from floor line to floor line is 9 feet 3 inches, and it is proposed to make each riser 6 inches high, reduce the height 10 inches, which would be 111; divide by the proposed height of each step—6 inches—the quotient will be 18, with 3 remaining. This gives 18 steps of 6 inches, plus 3 inches. Divide this remainder over the number of steps, which gives the quotient $6\frac{3}{18}$ inches, or $6\frac{1}{6}$ inches, which is the exact height of each step. Another way is to proceed as first mentioned above, and divide the whole height, 111, by the number of the steps, 18, giving the same quotient $6\frac{1}{6}$. If there are intermediate landings or half spaces, their dimensions must be allowed for. The size of the tread is obtained by dividing the go by the number of steps. The quotient will be the width of tread. Great care should be taken in setting out the rods and pitch boards. It is better to measure thrice than to cut twice. When the string line is marked on

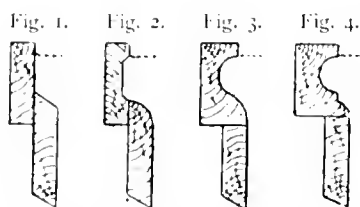

NO. 193.—SECTIONS OF NOSING
MOULDS WITH RISER BOARDS.

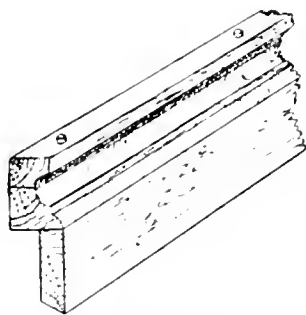

NO. 194. JOINTED NOSING MOULD
WITH RISER BOARD.

the wall, a chase about $4\frac{1}{2}$ inches deep is cut into the wall. It is not necessary to cut the chase straight at the soffit line, as it is apt to cut into a half, or rather a whole brick, and leave the ends loose. The irregular line of chase below the soffit line can be made solid during the process of filling in the steps. The chase should be cut as the work proceeds. Not more than one flight at a time should be cut, to avoid weakening the wall. In some instances a brick course in sand is left by the bricklayers. The bricks are then taken out as the work proceeds.

NOSINGS AND RISERS.—Nosing mouldings should be strong and bold. A simple but well-defined moulding not only gives greater strength, but is more in keeping with its purpose than one with numerous or small members. Nosing and riser moulds are best formed in two parts, the nosing mould being one part, and the riser board the other. To cut them out of the solid would not only be expensive, but also cumbersome to fix. They can be run at most saw and moulding mills. They should be run in lengths, and then cut and mitred on the job. Illustration No. 193 shows various forms of nosings. Fig. 1 is a simple nosing for common work. Fig. 2 may be used for school stairs, &c. Figs. 3 and 4 are well adapted for a good class of work. It will be seen that the lower edges of the riser boards are splayed. This is to admit the shoe of the running mould, also a trowel to work close up to face of the concrete riser when running and trowelling off the treads. The dotted lines indicate the line of tread. Nosing moulds are sometimes cut in the centre of the section, and afterwards the two parts are held in position with screws while the steps are being filled in. This allows the upper part to be unscrewed and taken off when the stuff is nearly set, thus allowing more freedom to trowel the surface of the tread, also to make a better joint while the stuff is green, and at the part that is cast and the part to be trowelled. The joint in the nosing mould leaves a thin seam which is easily cleaned off, whereas the joint of the tread and nosing is not only seen more, but is also more difficult to make good. Illustration No. 194 shows the mould and joint and screws for fixing same.

FRAMING STAIRCASES.—The wood framing for concrete stairs differs from, and is partly the reverse to that used for wood stairs. The nosings are formed the reverse of the moulding, and the

whole framing is so constructed that it forms a mould to cast all the steps and landings, from floor to floor, in monolithic form, or one piece. When the positions of half spaces or other landings are set out on the walls, strong planks are fixed on edge so as to give fixing joints for the carriage and outer strings. The strings are then fixed to act as guides for fixing the centring, risers, and nosing moulds. Where practicable, the outer string should be so arranged in the fixing that it can be taken off after the concrete is firm without disturbing the centring. This allows the returned ends of the steps to be cleaned off while the work is green. The carriage boards are fixed from landing to landing. Illustration No. 195 shows the forms and positions of the various parts, with their names. Bullnoses or curtails and circular parts of nosings are formed in plaster moulds which are run with several reverse running moulds.

Staircases between walls are more simple than open staircases, therefore they are more easy to

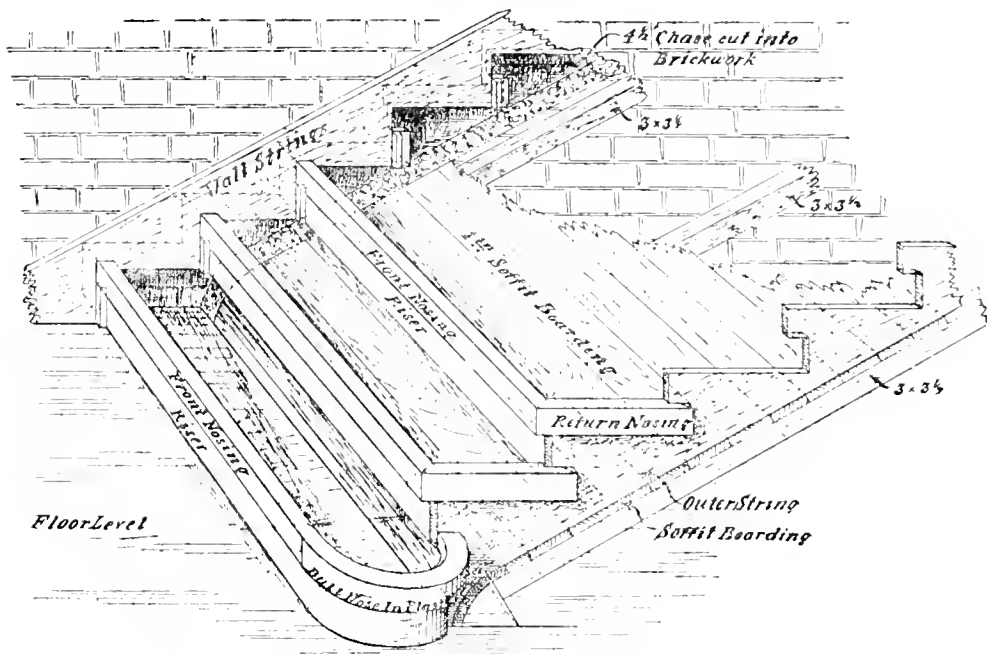

No. 195.—FRAMING FOR CONCRETE STAIRS CONSTRUCTED IN SITU.

frame up. The string boards are cut to the reverse of that used for wood stairs. A string is cut for each wall. The riser boards are then fixed to the wall strings. The centring for the soffits is fixed independently, the boards being laid on fillets which are nailed on each wall. For short flights of steps or common stairs, such as for cellars, &c., string boards may be dispensed with. The positions and sizes of the risers, treads, soffits, and landings are first set out and marked on the walls. Riser fillets are then nailed on the walls, taking care to keep each fillet in a line with the riser mark, and to allow for the thickness of the riser boards which are subsequently nailed on the inner sides of the fillets. Riser boards for winders are generally hung on long fillets, and then nailed on the walls. Long fillets extending upwards enable the work to be easier and more strongly fixed, as they extend over more brick joints than if cut to the exact height of the riser.

CENTRING FOR LANDINGS AND SOFFITS. — Centring for landings and the soffits of stairs should be made strong and true. The timber should be well seasoned, to prevent warping or

shrinkage. The outer angles of landings should be supported by strong wood props, not only to carry the immediate landing, but to carry another prop for the landing above. All centrings should be made perfectly rigid, to stand the weight of the concrete and the ramming. Great care should be taken that the timber framing is securely supported, as any deflection will not only throw the work out of level, but will also tend to crack the concrete. The principal props should be cut about $\frac{1}{2}$ inch shorter than the exact height. They are placed on a solid bed, the $\frac{1}{2}$ inch space at top being made up with two wedges, the thin ends being inserted in opposite directions and gently driven home from each side until the exact height is obtained. If it is difficult to get to the top of the prop, the wedges can be inserted at the bottom. The use of the wedges will be seen when the centring is struck. If there are winders in the stair, the centring for the soffit will be more or less circle on circle. This form of centring is done by lathing with 1-inch boards cut to a taper, the surface being made fair with gauged lime and hair. Rough $1\frac{1}{2}$ -inch boards are used for the centring. This should be close-jointed. Open joints or sappy timber act as a sieve, and allow liquid cement to drip through, thus robbing the concrete of its strength.

WATERPROOF CENTRING.—The following is a method that I have used with marked success for the soffits of stairs, landings, and the ceilings of floors. The initial cost of preparing is small, and is repaid with interest by the decreased cost of setting and the increased strength and solidity. For ordinary work, such as warehouses, &c., it is very suitable, as a finished surface is formed, and no setting required. It seems strange that, when casting concrete work out of a wood or a plaster mould, the mould is seasoned, and every precaution taken, not only to stop suction, but also to prevent the escape of liquid cement; but when casting a large surface *in situ* (where every precaution should be taken to obtain the maximum of strength), any kind of centring (which is a mould) is thought good enough, if only sufficiently strong to carry the concrete till set. I am aware that many workers in concrete think that an open or porous centring is a benefit instead of a defect, simply because it affords an escape for excess water. But why have excess water at all? There is no gain in time or strength, but a direct loss in both points. The excess water descends through the concrete by force of direct gravitation, and always carries a certain amount of liquid cement with it to the centring, leaving the aggregate more or less bare, and the body of the concrete weak. A part of the liquid cement also oozes through the joints and crevices, which leaves the skin of the concrete bare and broken. There is no reason or excuse for excess water, and it is simply the result of ignorant or careless gauging, which is not only a waste of time, water, and cement, but a loss in the ultimate strength, and the cause of cracks. Porous centring is also a dirty process. The overhead drip, drip, is neither good for workmen nor the materials underneath.

The process of forming the rough centring boards watertight is simple and expeditious, being done by laying the rough board surface with a thin coat of gauged plaster; and when the centring has been struck, the plaster will come with the boards, leaving the concrete with a fair face. The ramming forces a certain amount of water to the lower surface or centring, and this is so close and fine that it takes an exact impress of it; consequently, the truer and smoother the centring, the truer and smoother the concrete surface. The film of water indurates the skin of the concrete, and prevents surface or water cracks. It will be noticed, when filling in dry or porous plaster moulds, that the concrete cast produced has a surface either friable when newly cast, or when dry the surface is full of small water lines, like a map, or a broken spider's web. This is owing to the suction caused by the porous nature of the mould, and the water escaping through the weak or open parts leaving corresponding lines on the concrete surface. These defects are

obviated by using waterproof centring. Fine examples of concrete stairs finished by this method are to be seen in Throgmorton Avenue, London. These works were executed by James Nunney, under the author's supervision.

Where fineness of finish is not required, such as warehouse floors, the surface can be made sufficiently fair and smooth when filling in the concrete without subsequent setting. The plaster is laid on the centring and made fair and smooth, and then the surface is saturated with water to correct the suction, or the surface, if dry, may be brushed over with a thin soap solution to prevent adhesion. On this surface a coat of neat Portland cement about $\frac{1}{2}$ inch is laid, and on this the concrete is placed. The two unite in one body, and when set, and the centring struck, the plaster shell comes with the boards, leaving a smooth surface. This surface can be made in colour by lime washing, which will also give more light, or a finished white surface can be obtained by substituting Parian or other white cement for the neat Portland cement. The concrete must not be laid until the white cement is firm, not set, otherwise the concrete will force its way in thin or soft parts, and disfigure the surface. I have successfully used this method for obtaining a finished white surface when encasing iron girders with concrete for fireproof purposes.

STAIRCASE MATERIALS.—With regard to the materials for a concrete staircase, no one who intends to construct them substantially, fireproof, and economically, can afford to use common substances, when by judicious selection and for a trifling additional first cost a combination of materials can be obtained, which, if not (strictly speaking) fireproof, is at least the most incombustible constructive compound known. This is a quality of the most vital importance in modern house construction. Portland cement and slag cement are the best known matrices. The finer Portland cement is ground, the greater its heat-resisting powers. Slag cement is lighter than Portland cement, and its fire-resisting properties exceed those of both gypsum and Portland cement. But as its manufacture is as yet somewhat limited, and its strength not uniform, exceptional care must be exercised in testing its general qualities before using it for staircases. Broken slag, firebricks, clinkers, and pottery ware are the best aggregates, being practically fireproof. All should be clean, and in various graduating sizes, from that of a pin's head to that of a walnut, for roughing out with. The topping should be the same as that described for Eureka paving.

FILLING IN STAIRS.—Before gauging the materials, sweep out all dust in the interior of the framing and the wall chase, and then wet the latter, and oil the woodwork. If the wood of the nosing moulds and risers is sappy or open-grained, the long lengths, before being cut and fixed, should be made smooth and indurated by coating with a solution of hot paraffin wax. The smoother and less absorbent the surface of the wood, the more readily and cleaner will the mould leave the cast work. Paraffin also renders the wood damp-proof, thus preventing swelling or warping. For ordinary purposes one or two coats of paraffin oil will be found sufficient. This should be done two or three hours before the steps are filled in, so as to allow the oil to partly dry in and stop the pores of the wood. If the wood absorbs all the oil, and has a dry surface, brush the surface again with paraffin, using a semi-dry brush. This should be done as the work proceeds. If the surface is over wet, the oil mixes with the cement, thus causing a more or less rough surface. Soap solution may be safely used for rough concrete, or where a rough surface is left to be subsequently set. In the latter case, the surface must be well wetted with water and scrubbed before the final coat is applied. Soap solution may also be used for rough framing, such as soffit boards, but soap should not be used for fine concrete or a finished surface, as it leaves a film of grease which has a tendency to prevent the cement adhering when clearing up or making good the finished

surface. As the work of filling in proceeds, the surface should be brushed over with slip, *z. e.*, neat cement, to fill up all angles, and obtain a surface free from "blubs" and ragged arrises.

The coarse concrete for roughing out the stairs is composed of 1 part of Portland cement and 3 parts of coarse fireproof aggregate. These materials must be gauged stiff, and laid in small portions of about a pailful at a time, taking care to thoroughly consolidate by ramming and beating with a wooden mallet, using a wooden punner or punch to get into the angles and deep parts. When the first layer, which may be about 3 inches thick, is rammed, another layer is deposited and rammed, and so on until the rough stuff is within $\frac{1}{2}$ inch of the line of tread. It must not be omitted to brush the strings, treads, and nosing moulds with slip as the work proceeds. This is most effectually done by the aid of a tool-brush. Care must be exercised when ramming stairs with mallets or punches that the mallet or other implement used is not too large or heavy, or it

would most likely cause the framing to bulge out, and the form of the work would be irretrievably spoilt. During the operation of ramming, some of the water and a part of the constituent of the cement is forced upwards, and leaves a thin, smooth, clayey film on the surface, which prevents the adhesion of the next layer. For this reason the successive layers should be deposited before the previous one is set, and the topping should be laid while the coarse concrete is yet green. Too much stress cannot be laid upon the importance of topping the rough coat while it is green. This is one of the secrets of success of solid and strong work, so no more rough stuff should be laid than can be topped before the rough is set.

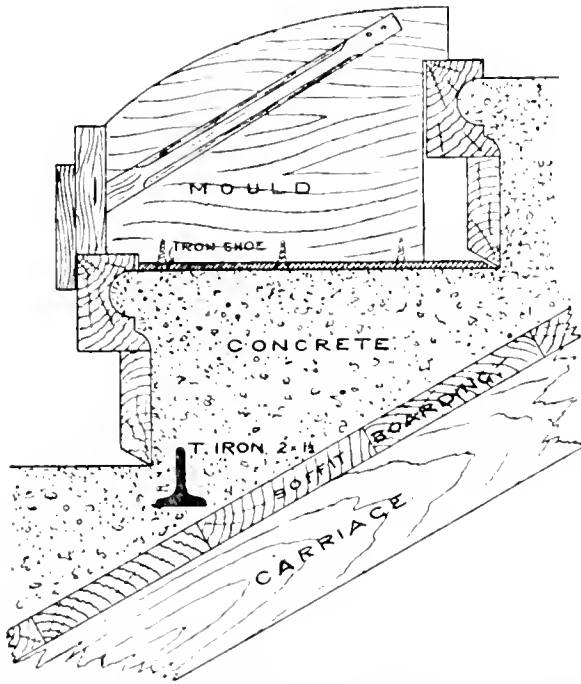

NO. 196.—SECTIONS OF FRAMING OF SOFFIT OF STAIR, RISER AND NOSING MOULD, WITH CONCRETE AND TREAD RUNNING MOULD IN POSITION.

and form the tread. The shoe projects so that it will work under the riser board close up to the concrete riser. Illustration No. 196 shows a section of steps with the mould in position, also a section of the nosing mould and soffit boards and carriage. The end of the slipper next to the wall is cut short to allow the mould to run close up to the wall. A section of a T iron is shown as sometimes used as an internal support. Iron is used for long steps, or where stairs are intended for heavy traffic. Iron helps to support the concrete until set; it is placed in alternate steps, or in every third or fourth step, according to length of step. Ordinary sized steps require no iron, unless as a support for the concrete while green, and during the process of making.

FINISHING STAIRS.—When the treads are firm after being run, the upper part of the nosing moulds are removed, the surface and joists trowelled off. The advantage of having the nosing mould in two parts will thus be seen, as it allows the joint at this most noticeable part to be

neatly cleaned off while the work is green. The lower part of the mould will support the concrete nosing during the finishing of the tread, and until the concrete is set. If the work is done with a nosing mould in one piece, which necessitates its being left on until the concrete is set, the joint has then to be filed down and stopped, and however well done, has a patchy appearance. When the treads are finished, and the work set but not dry, the riser and string boards are taken off, the joints made good, and the returned end of the steps cleaned off. If the stuff has been properly gauged and rammed, there should be little or no making good required, but it is important that if necessary it should be done while the work is green. A thin layer of neat cement will not adhere on a dense and dry body of concrete. The only way to obtain permanent cohesion is to cut the damaged surface out to a depth of not less than $\frac{1}{4}$ inch, then thoroughly wet it, brush the surface with liquid cement, and fill it in with gauged cement. No traffic should be allowed on the treads during the process of setting and hardening. The work is further protected and hardened by covering with sacks kept wet for several days by frequent watering. Where there are several flights of stairs to construct, there should not be less than three sets of strings and riser boards, which will enable the carpenter to fix one set while the plasterers are filling in and cleaning off the others.

NON-SLIPPERY STEPS.—Incessant traffic tends to make the treads of steps more or less slippery. In order to obviate this, the surface is indented with a concrete roller, similar to that used for some kinds of paving. Another way is to form three or four sunk V-shaped grooves from $\frac{1}{2}$ inch to 2 inches apart, on the treads while the concrete is moist. Another way is to insert leaden cubes about 1 inch square from 2 to 3 inches apart in the surface of the treads. Well-seasoned hard wooden blocks, about the same size as the lead, and fixed in a similar way, keeping the end grain vertical, are also used for this purpose. Indiarubber and cork cubes may also be used. Excellent examples of grooved steps (some cast and some formed *in situ*) are to be seen in the stairs leading from the subway to the grounds of the Natural History Museum, and to the station at South Kensington. This work was done by the Patent Metallic Paving Company. R. Walker was the foreman concreter for the stairs, and James Hill foreman for the concrete paving in the subway, the whole being done under the author's supervision. For patent non-slippery steps see page 516.

STRIKING CENTRINGS.—This should not be attempted until all the other work, with the exception of finishing the soffits, is done. It will be understood that the framing can be arranged so that the string and riser boards can be taken off without disturbing the soffit centring, which is kept up as long as possible. The time for striking centring greatly depends upon the class of cement used, the manner of gauging and laying the concrete, and the temperature; but generally speaking, centring should not be struck for at least ten days. A stair between walls can be struck much sooner than one having only one bearing by which its own weight is carried. I have seen a stair, with steps projecting 3 feet 6 inches from the wall, cleared of all supports in five days from the time of filling in; but this was with a good cement, gauged 1 part to 2 of aggregate, and in warm weather, and the stair was strengthened with T iron.

The centring and framing for a flight of stairs should, where practicable, be independent of other stairs above or below, so that they can be struck in due rotation. The wedges of the main props should be gradually withdrawn. This tends to avoid the sudden jar which otherwise often happens when the centring is too suddenly struck. The sudden removal of centring and the inflexible nature of concrete are the cause of body cracks. The damage caused by the sudden jar may not be seen at the time, but it will be eventually developed by the force of expansion, which always finds out the weak spots.

CONCRETE AND IRON.—Iron pipes, bars, and T pieces are sometimes used with concrete

stairs where the steps are long, or where landings have little support from walls. They help to carry the dead weight until the mass is thoroughly set, and also prevent sudden deflection if the centring is struck too soon. When iron pipes are used for steps, they should go right into the wall chase. Iron T pieces are used for long landings. Care must be taken that, if iron is used, no part should be left exposed. It must be embedded in the concrete to protect it from oxidation and the effects of fire. When iron girders, &c., are partly exposed, they should be painted. Iron bars or pipes are occasionally used to strengthen the outer strings of spandrel stairs. The iron is laid in the moist concrete near and along the string, having the ends projecting into the walls or landings. Angle irons are often used for unsupported concrete angles. Iron pipes, bars, or joists are used as integral supports for landings and floors having unsupported ends.

The tensile strength of bar iron is materially increased by twisting. A bar $\frac{1}{2}$ inch square with three twists per foot, or a bar $\frac{1}{4}$ inch square with five twists per foot, will gain about 50 per cent. in tensile strength when embedded in concrete, and give a corresponding strength to the concrete. A combination of iron and concrete is of special service where space is limited. For instance, if a beam or landing requires a certain thickness to carry a given weight, and it is inconvenient or difficult to obtain that thickness, the requisite degree of strength with a reduced thickness may be obtained by the combination of both materials. This gives the combined iron and concrete a useful advantage over stone. It is important to secure the full strength of the iron, and that none be lost or neutralised. In order to obtain the full strength, the iron should be judiciously placed. Thus a piece of iron surrounded by twenty times its sectional area of concrete would increase the weight-sustaining power of the iron about twenty times, and concrete with one-twentieth its sectional area of iron in the centre would have its strength increased about twice. If the same quantity of iron was placed in several pieces, so as to throw as much tensile strain on the iron as possible, the strength would be increased nearly four times. In order that none of the strength be lost or neutralised, the iron should be placed near the lower surface; if fixed higher, they are nearer the axis of neutral stress, and are correspondingly less effective. The use of iron in concrete is invaluable for many constructive purposes, but for general work, unless as a temporary aid and in a few exceptional cases, it is unnecessary. For all other things being equal, the huge hoard of reserve strength in good concrete is alone sufficient to sustain as great if not a greater weight than that sustained by natural stone. No other artificial compound exceeds the strength of the natural substance, as does artificial stone composed of Portland cement concrete.

SETTING CONCRETE SOFFITS.—The soffits of stairs and landings, if neat cement has been used on a waterproof centring, as already described, only require a little stopping and colouring, but for work done on rough centring a setting coat has to be laid. This is usually done with neat Portland cement, though it is frequently gauged with lime putty to make it work more freely. The surface should be well roughened and wetted, to give a key and obtain perfect cohesion. It requires great care and time to make a good and true surface with Portland cement on a body of concrete, especially if the concrete is dry, which is generally the case where there are several flights of steps in a staircase, and the setting of the soffits and landings are left to the last part of the work. I have obtained equally good results by using Parian or other white cements for setting the soffits of staircases. When using white cements for this purpose, it is better to brush the concrete surface with liquid cement before laying the gauged cement. The laying trowel should follow the brush, or at least before the liquid cement dries in. This not only secures better cohesion, but tends to prevent the setting coat peeling when trowelling it off. Soffits are sometimes set with gauged putty. This is like putting a beggar on horseback, and the work is never satisfactory.

FIBROUS CONCRETE.—As already mentioned, canvas and other fibrous materials may be advantageously used with Portland cement for several purposes. Canvas forms a good ground for a setting coat on concrete surfaces. It gives a uniform and strong key, prevents surface cracks, and the final coat from peeling. Coarse canvas cut to convenient sizes is used. It is laid on the centring, and held in position with tacks, or with the same kind of cement as intended for the final coat. The canvas is then brushed with liquid cement, and then the concrete is laid while the canvas is moist, so that the whole will form one compact body. When the centring is struck, the fibrous concrete surface is roughened with a sharp and fine drag, so as to raise the fibre of the canvas, thus giving a fine, regular, and strong key. This surface requires less material for the final coat than the ordinary concrete surface. If tacks are used, they must be extracted before the final coat is laid, to avoid discoloration. The rough concrete and the white surface coat may also be done in one operation. The centring is made fair and smooth, and then oiled with chalk oil. The white cement is gauged stiff, and laid on the centring. Coarse canvas is then laid on and well brushed with liquid cement. When this is firm (but not set), the surface is again brushed, and then the concrete is laid. The concrete is deposited in two or more layers. The first must not be too thick, taking care that it is well rammed or pressed on the moist canvas surface without disturbing the white cement. After the centring is struck, any defects on the surface are made good. The surface may be then left white, or painted, or polished as required.

POLISHED SOFFITS.—Soffits, landings, and strings of concrete stairs that are finished in white cement may be polished. The material may be tinted, or left in its natural white or creamy colour. Polished cement work is always bright, and has a lustre like marble. Being durable and easily cleaned, it is more sanitary and cheaper than paint. The polishing is done the same way as described for "white work" in Chapter XV.

CONCRETE STAIRCASES AND FIBROUS PLASTER.—Fibrous plaster is well adapted for concrete surfaces when an enriched finish is desirable. I have introduced this material for decorating the soffits of steps and landings, also the strings of concrete stairs. By this method the soffits and strings can be panelled, or enriched with medallions or foliage, as required. The soffits may also be enriched with modelled work done *in situ* with some of the white cements, or with plaster and tow. The strings may be decorated with hand-worked gesso. In order to obtain a fixing or keying substance that will receive nails or screws to sustain the fibrous plaster, a rough plan of the design, or rather the fixing points, is set out on the inside of the centring before the concrete is laid. On these plans, wood plugs, fillets, or concrete fixing blocks are laid, and held in position with nails, plaster, or cement until the concrete is laid and set. Care must be exercised when fixing the plugs or fillets that the centring will leave freely without disturbing the plugs, &c. The use of fixing blocks for this purpose is illustrated in Chapter XI. If the steps are cast and built, the plugs or fixing blocks are cast with the steps. The principal staircase of the Tower, London, constructed by my son, J. Millar, for the Patent Paving and Construction Company, is a good example of the combination of concrete and fibrous plaster.

DOWEL HOLES.—Cutting dowel holes in concrete to receive iron or wood balusters is a slow and tedious process. They are best formed by means of wood plugs, which are fixed before the concrete is laid, or they may be driven in the concrete while soft. If the balusters are to be fixed on the treads, the plugs are driven into the rough concrete before it is set, leaving them flush with the line of tread, so that when the treading is laid they will not be in the way. Plugs are best fixed by the aid of a wooden gauge. The gauge is made the same thickness as the treading, the length being equal to the distance between the nosing mould and the riser board, and as wide as will admit of

plug holes and the plugs to be driven through. The plugs are made a little larger than the baluster ends to allow for lead. The gauge is laid on the rough concrete, using the returned nosing mould as a guide, and then driving the plugs flush with the top of the gauge. The gauge is then lifted up and laid on the next step, and so on until the finish. This method is accurate, and saves measuring and marking the position of each hole on every step. When balusters are fixed on the ends of the steps, the plugs are fixed on the inside of the outer string. The plugs are generally left in until the balusters are ready for fixing. A ready method for forming "lewis" holes or other undercut sinkings in concrete is performed by casting wedge-shaped blocks of plaster of the required form and size, and then laying them in the desired positions while the concrete is soft. When the concrete is set, the plaster blocks can then be easily cut out, leaving the undercut sinking as desired.

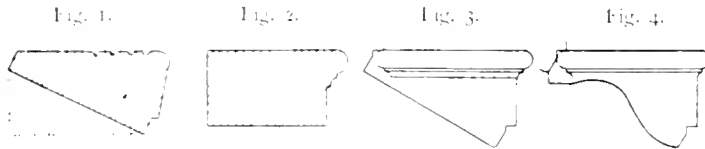

NO. 197.—SECTIONS OF STEPS.

from the foregoing that the operations employed in the construction of concrete staircases formed *in situ* are—(1) Setting out the stairs and landing; (2) fixing the wood framing; (3) gauging the materials and filling in; (4) removing the framing; (5) cleaning up the treads, risers, and strings; (6) striking the soffit centring and finishing the soffits; 7 protecting and wetting the work until set and hard.

CAST STEPS.—Staircases are also constructed with steps cast separately, and then built in, in the same way as stone. Illustration No. 197 shows various sections of steps. Fig. 1 is a spandrel

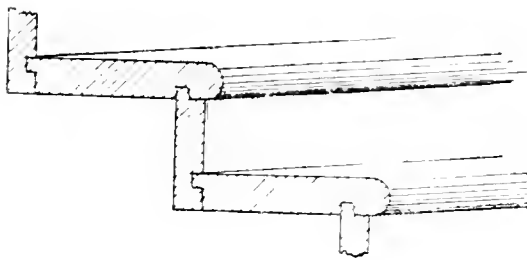

NO. 198.—TREADS AND RISERS.

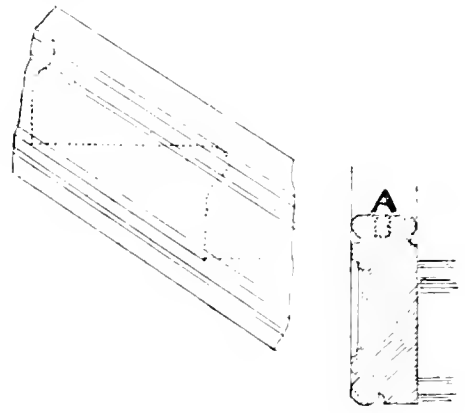

Fig. 1.

Fig. 2.

NO. 199.

step, which may be used for model dwellings, factories, &c. The tread is grooved to afford a good footing and prevent dipping. The dotted line indicates a square seating or tail end of the step, which is embedded in the wall. Fig. 2 is a square step. Fig. 3 is a step with a moulded and returned nosing. Fig. 4 is a similar step, but having a moulded soffit. For cast work these steps must have a square seating or tail end as indicated by the dotted lines on Fig. 1, so as to bond into the wall.

TREADS AND RISERS.—Stairs between walls are sometimes formed with treads and risers. The treads and risers are cast and built in as the construction of the work proceeds. Sometimes they are let into chases, and pinned after the walls are built. Illustration No. 198 shows a section of treads and risers.

CLOSED OUTER STRINGS.—Staircases are sometimes finished with a close outer string, which prevents dirt or wet falling into the well. Illustration No. 199 shows the section, Fig. 1, and the elevation, Fig. 2, of a moulded outer string. The dotted line at A indicates a dowel hole for the balusters. Outer strings, whether plain or moulded, are much stronger when formed *in situ*. This is best effected by fixing a reverse mould at each side, then filling in the space from the top. The top is finished by hand and the aid of a template. The dowel holes are formed as already described.

CONCRETE FLOORS.—It has already been mentioned that the Romans, in the time of Julius Cæsar, were in the habit of constructing their floors and roofs, as well as their walls, of concrete. According to an article in *Archæologia*, the cementitious agent was *pozzolana*. This substance, when mixed with lime, forms a natural hydraulic cement. The lime was obtained by burning "travertine." The aggregate usually consisted of broken tufa for walls, of broken lava for foundations where great strength was required, and of broken pumice where lightness was essential. The floors were generally constructed of large slabs of concrete, supported on sleeper brick walls. The upper surface was finished with a layer of finer concrete and mosaic. The roofs were made flat, resting on brick pillars. The first known English patent for fireproof construction was obtained by one Dekins Bull in 1633; but as at that period patentees were not compelled to disclose what their patents covered, no description of the materials and methods can be given. Up to the middle of the eighteenth century fireproof floors usually consisted of brick arches, but owing to their great weight and cost, were seldom used. But towards the close of that century cast-iron girders and segmental brick arches were gradually coming into use where strength was essential. Up to a century ago plaster was largely employed as a floor material. In 1778 Earl Stanhope invented pugging for rendering wooden floors fireproof. By this process fillets were nailed to the joists at about one-third of the height. Laths were laid on the fillets, and plastered above and below with a coat of lime and chopped hay. The under sides of the joists were then lathed and plastered in the usual way to form the ceiling. About the early part of the present century wrought-iron joists were substituted for cast-iron girders. Fox & Barrett's floor, designed about 1830, was the first in which an attempt was made to protect the exposed faces of the iron joist with a fire-resisting material. Hornblower's floor is one of the earliest for resisting the effects of fire. Iron, bricks, and plaster are chiefly used in the French and American systems. Among the many modern systems now in use in England may be mentioned those of Dennet, Wilkinson, Homan & Rodgers, Doulton, Peto, Mark Fawcett, Potter, and the author, &c. For the sake of simplicity and reference, concrete floors may be divided into three kinds:—1. "Joist floors," in which the concrete is laid solid between the joists. 2. "Tubular floors" formed with fireclay tubes or hollow lintels placed between the joists and covered with concrete. 3. "Slab floors" formed in one piece or slab. Portland cement concrete laid *in situ* on and between iron joists is extensively used for fire-resisting structures. Cast concrete is used for some parts of tubular floors. For my patent Phoenix fireproof floors and partitions, concrete alone is used. Cast concrete blocks are used for the ceiling surface, and as a support for the rough concrete floor surface. The blocks are hollow, and have male and female dovetails on the sides. The ceiling surface of the floors and the outer surfaces of the partitions are finished with a thin setting coat of gauged putty or Parian. The chief objects of fireproof floors are to render each floor capable of resisting the effects of fire, so that fire cannot be communicated from one floor to another, and by making the roof fireproof, to prevent fire from spreading from one compartment to another; to gain additional strength, so as to avoid as far as possible lateral thrust on the walls, and to secure

the building from the attacks and effects of both dry rot and damp. There have been about a hundred patents for fireproof floors during the last generation, of which about five or six survive.*

PLASTER FLOORS.—Plaster concrete, that is, plaster and broken bricks, or similar aggregates, also neat plaster, were at one time used largely for the formation of floors. The use of plaster floors was common in some districts, and up to a century ago the rough plaster, known as "floor plaster," was in general use in the midland counties, or where gypsum was found in abundance. Plaster floors were rarely used on the ground level, because they could not resist moisture, which caused them to become soft and retain the damp. They were principally used for upper floors. The gauged plaster was laid upon reeds similar to those used for lathing before the modern plasterer's lath came in, which were so plentifully obtained from the swamps and undrained lands in the Lincolnshire and Cambridgeshire fens. These reeds were spread upon the tops of the joists, and over them was laid straw to keep the soft plaster from percolating through the reeds. The floors were about 3 inches thick, floated fair, and finished the following day. Wood strips were placed around the walls, and drawn out when the plaster began to set, to allow for the expansion of the plaster. The materials being so light, the timbers were less in size and number than those now in use. The joists were in some instances only $3\frac{1}{2}$ inches by $2\frac{1}{2}$ inches, fixed wide apart, and supported by small beams about $4\frac{1}{2}$ inches by $3\frac{1}{2}$ inches. The under sides between the joists were made fair by plastering the reeds, but in the better class of work the joists were covered with reeds, and held in position with oak laths, and plastered. Bullock's blood was used to harden the floors after they were dry. In some instances they were coated with linseed oil to increase their hardness. Their use is now practically superseded by Portland cement concrete. Dennet & Inglis' well-known fireproof floors are chiefly composed of coarse plaster and broken bricks.

JOIST CONCRETE FLOORS.—For this form of floor the concrete is laid between, over, and under the iron joists. Beyond the supervision of the fixing of the centring and the gauging of the materials, little skilled labour is required. The rough concrete is laid between and partly under the iron joists, which are fixed from 3 feet to 5 feet apart, according to the span and strength of the joists. The centring is supported, or rather hung, by the aid of timber laid across the joists, and secured by bolts. The materials are generally Portland cement and gravel, coke-breeze, clinkers, and broken bricks, gauged in the proportion of 1 part of matrix to 5 of aggregate. Gravel, owing to its weight and roundness, is not a desirable aggregate. Sand equal to one-third of the bulk should always be added. Coke-breeze is weak, light, and elastic, but combustible and porous. A mixture of gravel and breeze in equal proportions is better than either alone. The proportion of cement varies according to the span and class of aggregate. All other things being equal, the strength of concrete is influenced by the strength of the aggregate, so that it would take a greater proportion of cement to make coke-breeze concrete equal in strength to a concrete made with hard aggregate, such as granite, slag, or brick. The upper surface of this class of floor may be finished with wood, tiles, or fine concrete, as required. Joist concrete floors have been largely used. This is principally owing to their supposed cheapness; but it is more than probable that, in the event of fire, they would be dear in the end, because the lower part of the flanges are barely protected from the effects of fire, as the concrete, being thin at these parts, and also on a comparatively smooth surface, would soon crack or scale off, and leave the flanges of the joists exposed to the ravages of fire. They are also more or less conductors of sound. Caminus concrete cement is an excellent material for the construction of fireproof ceilings and partitions.

* Those desirous of further information on this subject are referred to a very practical and useful work, entitled "Concrete, its Uses in Building," by T. Potter. Published by B. T. Batsford, 94 High Holborn, London.

CAMINUS CONCRETE CEMENT.—This material is specially designed to produce a hard and practically indestructible concrete for the construction of fireproof floors and walls. It is manufactured from a waste product, and all inflammable material such as coke-breeze being entirely dispensed with, the concrete is thoroughly fire-resisting. It is lighter and much cheaper than Portland cement concrete, and is perfectly free from expansion and contraction whilst setting. It can be manufactured to set in a few hours, so that the centres can be struck the day after the floor is laid. It can be supplied in a ready aggregated condition, so that the bags may be hoisted direct to the floor where the concrete is being laid, and gauged on the floor, thus saving a great amount of waste, and also labour in handling, mixing, and laying.

CONCRETE FLOORS AND COFFERED CEILINGS.—A method was patented by E. Ransom, in America, for decreasing quantity of material and yet obtaining equal strength in floors. The floor is divided by a series of beams at right angles to each other, so as to form a series of coffers in the ceiling. For instance, for a floor 12 inches thick, the floor proper would be about 4 inches thick, and the beams about 3 inches thick and 8 inches deep—a rod of twisted iron being placed in the centre of the thickness, and near the lower surface of the beams. The beams are generally about 2 feet 6 inches from centre to centre. The method of construction is as follows:—First form a platform or centring; on this a series of core boxes 2 feet 3 inches is placed, 3 inches apart, so as to form a 3-inch beam. The core boxes must be tapered and their upper edges rounded, so that they will draw when the centring is struck. The size of the core boxes may be altered to suit the size and requirements of the floor. With regard to the iron bars, the inventor says: "It is of vital importance for the strength of the structure that the iron bars be placed no higher in the beam than calculated for; that the longitudinal centre of these bars should be at the lowest point; and it is advisable that the bars curve upwards slightly and uniformly each way from the centre to the ends, so that the ends are from 1 to 2 inches higher than the centres. By preparing the concrete bed on a corresponding curve, the natural sag of the bar, as it is being handled to its place, gives all the requisite facility to accomplish this purpose. No crooked or irregularly twisted iron must be used, otherwise, when the strain comes upon it, it will perforce straighten and lengthen out, and weaken the structure in so doing. After placing the iron, the rest of the concrete is tamped in place, and the whole made to form a monolithic block. It is of vital importance that no stop be made in the placing of the concrete from the time the beam is begun until the thickness of the beam is in place and a 'thorough joint' is made. The web and the thickness must be one solid piece of homogeneous concrete."

COMBINED CONCRETE FLOORS AND PANELLED CEILINGS.—A combined floor and panelled ceiling may also be formed in concrete. This is executed as follows:—First form a level platform or centring, and on this fix the reverse plaster mould, run and mitred, according to the design of the ceiling. The intervening panels are then made up with framing, and the concrete filled in in the usual way, and when set the centring and the reverse mould are removed, and the ceiling cleared off. If desired, a finely finished and smooth white surface may be obtained by coating the surface of the moulds and panels with firmly gauged Parian, or other white cement, until about $\frac{3}{4}$ inch thick; and when this is firm but not set, the rough concrete is deposited in layers and tamped to consolidate the concrete, and unite it with the white cement. The surface may also be finished with fibrous concrete. The method of doing this, also for carrying out the above white cement process, is described in "Fibrous Concrete," page 495.

CONCRETE AND WOOD.—Concrete floors finished with flooring boards require special care to prevent damp or dry rot. There are various methods in use for fixing and keeping the flooring

boards from contact with the rough concrete, one way being to fix wood fillets to the iron joists by means of wedges or clamps. Another way is to embed wood fillets or fixing blocks in the rough concrete, leaving them projecting above the level of the iron joists, to give a bearing and fixing points to the flooring boards; or fine coke-breeze, concrete or plaster screeds, may be laid at intervals on the rough concrete, on to which the boards are nailed. Fixing blocks, concrete or plaster screeds, are preferable to wood fillets, as they do not shrink or rot, and will better resist fire. All these methods leave intervening spaces between the concrete and the boards, and unless thoroughly ventilated, they harbour vermin, dirt, and stagnant air. Unless the wood is thoroughly seasoned, and the boards grooved and tongued, dust and effluvia will find egress through the joints. A portion of dust and water when sweeping and washing the floors also finds an ingress through the joists; and as the concrete will not absorb the water, or allow the dust to escape, they accumulate and become unseen dangers. These insanitary evils may be obviated, or at least reduced to a minimum, by laying the boards direct on the concrete. This not only forms a solid floor with no interspaces, but admits of a thin board being used with as much if not greater advantage than a thick board. There is no uneven springing between the joists, which causes friction and opening of the joints, and the whole thickness is available for wear. There is also less total depth of floor, consequently less height of building and general cost. Another important advantage of a solid floor is, that it will resist fire better than one with hollow spaces. It is here that the sponginess and elasticity of coke-breeze concrete as a top layer is of special service, and where it may be utilised with advantage. Owing to its being able to receive and retain nails, the boards can be nailed at any desired place. Wood blocks for parquet floors can also be bedded or screwed on the concrete surface. Flooring boards will lie even and solid on this surface, and if a thin layer of felt or slag-wool be spread on the concrete before the boards are laid, a firm and noiseless floor is obtained. Slag-wool is an imperishable non-conductor of heat, cold, and sound, and it will not harbour vermin. If the work is in a humid climate, the coke-breeze surface when dry should be coated with a solution of tar and pitch, to prevent atmospheric moisture being absorbed by the porous coke-breeze.

CONCRETE DRYING.—To prevent dry rot it is of the utmost importance that the concrete should be thoroughly free from moisture before the flooring boards are laid and fixed. The drying of concrete is a question of time, which depends upon the amount of water used for gauging, the thickness, and the temperature. It may take from three days to three weeks or even three months. The drying can be accelerated by directing currents of hot air on to the lower surface, or by laying some absorbent material, such as dry sawdust or brick dust, on the upper surface. As soon as the surface moisture is absorbed, or the dry material has no further absorbent power, it should be removed to allow the mass to be air dried. Another way is to lay the floor in two coats, and to allow one coat to dry before the other is laid. For instance, if the floor is to be 6 inches thick, the first coat is laid with rough but strong concrete, the aggregate being the best available; but taking gravel and coke-breeze to be the most plentiful, it will be best to assimilate and combine the good qualities of each to equalise their defects by mixing them in equal proportions. If brick is plentiful, and broken to properly graduated sizes, it will give better results than the gravel and breeze. The mixed aggregate is gauged 5 parts to 1 of cement, and laid $4\frac{1}{2}$ inches thick, and gently but firmly beaten *in situ*, the surface being left rough to give a key for the second coat. The second coat is not laid until the first is dry, and consists of 1 part cement to 5 of sifted and damped coke-breeze, gauged stiff, and laid $1\frac{1}{2}$ inches thick, beaten *in situ*, ruled level, and any ridges being laid fair with a long hand-float. The moisture of the second coat, by reason of the density of the first coat, will only be

absorbed to a small degree, while the greater portion will be taken up by the atmosphere, and enable the combined coats to dry sooner than if laid in one. The first coat should be laid as soon as the roof is on, so as to give all possible time for it to dry, and the second coat to be laid and dried before the flooring is laid. When coke-breeze is not available for the second coat, use soft brick, broken to pass through a $\frac{3}{16}$ -inch sieve. The method of laying floors in two coats is only given as an alternative plan, and as an example of a process used in some parts. Greater strength as a whole, and more perfect cohesion between the two coats, is obtained by laying the second coat as soon as the first is laid, or at least while it is green.

CONCRETE SLAB FLOORS.—The term slab floor is applied to a concrete floor formed *in situ*, and in one piece or slab. It must not be confounded with slab pavements, which are constructed with a number of small cast slabs. Slab floors are usually made without exterior iron supports, but in a few instances iron T pieces or bars have been used as internal supports. Bearing in mind the lasting properties of the old Roman slab floors, and the enormous strength of the modern examples at home, which are unsupported by iron, and are practically indestructible, it seems strange that they are not in more general use, and that for some inexplicable reason preference is given to shrinking, rotting, and combustible floors, composed of foreign iron and timber instead of British work and material, which if a little dearer at first, is infinitely superior, and vastly cheaper in the long run. The great sanitary advantages and fire and damp resisting powers of concrete slab floors are the highest known. The construction of slab floors is simple, and similar in many respects to that already described for stair landings and ordinary concrete and joist floors. There are several methods of supporting the floors, the first and most common being to leave a sand course, or to cut a horizontal chase in the walls to receive the ends of the floors. The second is to lay the floors when the walls are floor high, and build the higher walls on it when set. This method, while making sound work, is not always practicable or convenient, owing to the delay in building while waiting for the floors to set. The third method is to build corbelled ledges in the walls, so as to carry the floors. The centring for slab floors should be perfectly rigid, water-tight, and slightly cambered towards the ceiling centre. This camber gives more strength to the floor, and lessens liability to crack when removing the centring. If joists are not used, the centring is supported on wall boards and centre struts. Another way which gives great additional strength is to form the centring level, but having all the edges at the wall rounded off, so as to form the floor like an inverted sink or tray. The horizontal chases in this case should be made wider than the thickness of the floor to allow for a thickness of rim. The extra width of chase, which may be one or two bricks thick, according to the width of span, is made below the centring or line of ceiling, the angles being coved by rounding the edges of centring. The coved rim gives greater strength with a less thickness of floor. The cove may be left plain, or used as a cove for a plaster cornice, or roughened and used as a bracket for the same purpose. The expansion of concrete floors having large areas, or where hot cement has been used, has been known to disturb the walls, causing cracks and displacement of brick and stone work. This may be prevented by isolating the floor ends from the walls. This is done by forming expansion partitions or linings in the chases, the linings being composed of slag, felt, or wood shavings, straw, reeds, or other compressible material. The chase should be sufficiently deep to allow for a compressible lining about $1\frac{1}{2}$ inches thick, and a fair bed for the slab floor. Care must be taken to leave a few half bricks solid at intervals, say from 3 to 4 feet apart, to support the upper walls until the floor is set. Compressible linings may be used for floors supported on corbelled ledges; and when the expansion, and in many cases subsequent contraction, has finally finished, the

linings can be taken out, and the vacant space filled up with fine concrete, or utilised as a ground key for cement skirtings. If girder or iron posts are isolated from the walls by means of compressible linings, the effects of expansion and sound are limited. In some instances a judicious use of iron may be made. For instance, large areas may be divided with three or four rolled iron joists, so as to form shorter spans or smaller bays. Joists tend to bind the walls together, and to serve as scaffold bearings for building the upper parts of walls. They may also be used for hanging the centring on instead of strutting, or as aids to the strutting. Joists may also be used as integral supports at unsupported ends of concrete floors. They should be so fixed that the lower flanges are not less than 1 inch above the lower surface of the concrete. The whole strength of iron is brought more fully into use by fixing it near the lower surface. If fixed near the centre, or at the axis of neutral stress, a corresponding part of the strength is comparatively of little value.

CONSTRUCTION OF SLAB FLOORS.—Portland cement as a matrix is indispensable. The unequal nature of gravel and coke-breeze render them unfit and unsafe aggregates for this class of work. Broken brick being cheap, and obtainable in most districts, affords a ready aggregate, and may be used with safety and success. In ordinary cases of concrete construction, the whole thickness is usually made with one rate of gauge; but for slab floors covering large areas, and unsupported by iron or other supports, exceptional strength is required. Stronger results are obtained by making up the whole thickness with different rates of gauge. Taking the usual gauge for floors as from 4 to 5 parts of aggregate to 1 of cement, and used for the whole thickness, it gives an unequal strength, a part of which is comparatively of little use, especially at the neutral axis; but if the cement is divided so as to form an ordinary coat in the centre, and stronger coats at the upper and lower surfaces at the points of greatest strain, the upper being compressive and the lower tensile, a better and more accurate arrangement of strength and allowance for disposition of strains is obtained. The additional strength at the proper places is obtained not by the use of additional cement, but by the method of construction, which enables the same quantity of cement as gauged for the usual rate for forming the whole thickness in one coat to be used more profitably. Take the section of an iron joist as an example; this gives divided yet united strengths, which sounds paradoxical, but is true. The flanges sustain the greatest strains, and the web comparatively little. With concrete, the strong coats at the upper and lower surfaces represent the flanges, and the ordinary coat the web. As already stated, the increased and profitable distribution of strength is obtained by the method of construction. For instance, take a slab floor 20 feet by 14 feet and 12 inches thick, without iron joists or other supports, and intended to carry a safe load of $2\frac{1}{2}$ cwt. per superficial foot, in addition to its own weight of say 1 cwt. per square foot. This floor is laid in three coats, the first composed of 1 part cement and 2 of fine broken bricks gauged stiff, and laid 2 inches thick; the second composed of 1 part cement and 6 of coarse broken bricks gauged stiff, and laid and rammed 8 inches thick; and the third composed of 1 part cement and 2 of fine broken bricks gauged stiff, and laid 2 inches thick. If the upper surface is intended for hard frictional wear, a slight difference is made in the gauge and materials. The first coat is composed of 2 parts of cement and 5 of fine broken bricks gauged stiff, and laid 2 inches thick; the second of 1 part cement and 6 of coarse broken bricks gauged stiff, and laid and rammed till 8 inches thick; and the third coat composed of 1 part cement and 2 of fine crushed slag or granite. It will be seen that this constructive method gives the desired positions of strength, and the total quantity of cement in the united gauges is 1 part to 4 and up to 5 parts of aggregate. The fine broken bricks should be passed through a $\frac{1}{2}$ -inch sieve, and the coarse through a 2-inch screen, taking care that the latter contains a greater quantity of the smaller pieces than of the larger. It must be clearly

understood that the second coat must be laid before the first is set, also that the third is laid before the second is set, so as to ensure perfect cohesion between each coat, and the absolute homogeneity of the whole mass.

HOLLOW FLOORS.—Greater lightness in concrete floors is obtained by the use of concrete tubes. If the tubes are placed apart and in the centre of the floor thickness, a hollow homogeneous concrete slab is formed. The vertical divisions between the tubes connect the upper and lower coats, as with the web of a joist connecting the upper and lower flanges. The method of construction is simple and expeditious. For example, for a slab floor 10 inches thick, first lay a coat 2 inches thick of the stronger and finer concrete, as described for the 12-inch slab floor, and when this is firm lay 5 or 6 inch tubes from wall to wall. Bed the sides with rough concrete, and lay another row of tubes parallel with the first row, and about 2 inches apart, and so on until the floor area is covered; then make up interspaces with rough concrete till level with the upper surfaces of the tubes, and then cover this with a coat of fine concrete 2 inches thick. Concrete tubes or common earthenware drain pipes may be used. Half-circle pipes, laid on their side edges, may be used to save concrete and weight in joist floors, &c.

CONCRETE ROOFS.—Concrete roofs require special care to render them watertight. Subsidence in the brickwork of new buildings is often the cause of cracks on concrete roofs. The roof should have a good camber, to give greater strength and allow for the fall of water to the outer edges. The rough coat should be laid and well consolidated by ramming or beating, and then left for seven days (the longer the better) before the topping is added. The upper coat should be strongly gauged with fine aggregate as in "Eureka." If possible, the topping should be laid in one piece. If the area is too large to be laid and finished in one piece the joints of the bays should overlap. This is done by rebating the screed rules, so as to allow one-half of topping thickness to go under a part of the rule, and form an underlap or ledge about $\frac{1}{2}$ inch wide, and when the adjoining bay is laid an overlapped but level joint is the result. Roofs exposed to the sun's heat should be kept damp for several days after being laid, as joints are affected by the heat as well as by deflection of centring or subsidence of walls. Compressible linings or wood strips should be used round the walls to counteract any expansion. All concrete roofs should have a cement skirting 6 inches high and 1 inch thick well keyed into the walls. If linings are not used when the topping is laid, the topping should be turned up on the walls, so as to form a rim, to prevent water getting between the roof and the walls. Greater heat and damp resisting powers are obtained by laying the upper surface with $\frac{1}{2}$ inch thick coat of special concrete, composed of 1 part of Portland cement, $\frac{1}{2}$ part of slaked lime, and 1 part of firebrick dust. This should be consolidated with a hand-float, and finished fine and close with a trowel.

NOTES ON CONCRETE.—When calculating the strength of floors, stairs, &c., the following facts should be borne in mind. Portland cement when new is too hot, sets more rapidly, and expands more than old cement. The finest ground cement is the best and strongest. The time in setting, and in which the maximum strength is attained, varies according to the age of the cement, the quantity of water used, and the mode of gauging and the mean atmospheric temperature. The maximum strength of a briquette of mature cement is maintained, while one of new cement "goes back." A briquette of matured cement will stand a tension strain of 550 lbs. per square inch, and a crushing weight of 6,000 lbs. per square inch. A briquette of neat cement is more brittle than one of concrete. Briquettes mature more rapidly than thick slab floors. The adhesive strength of Portland cement is about 85 lbs. per square inch. The adhesive strength increases more rapidly than the cohesive. A mass with a surface large in proportion to its volume sets more rapidly than

a mass with a small area in proportion to its volume. Masses subject to pressure set more rapidly and attain greater hardness than masses not so pressed. The average compressive strength of concrete is about eight times its tension strength. The proportion of compressional and tensional strength varies according to the quality and quantity of the aggregate. The strength of concrete depends greatly on the proportion of the matrix and aggregate, also on the strength of the latter. As regards bricks, it must be remembered that there is a wide difference between the tensile strength of hard well-burnt bricks and soft stocks. No bricks are so strong as cement, the best kinds being about one-fourth the strength of neat cement. Taking the gauge as 1 part of cement to 4 of broken brick, the strength of the concrete will be about two-fifths of neat cement, but for safe and practical calculations it will be best to take the strength as one-fourth of neat cement. Square slabs are stronger than rectangular slabs. Slab floors being homogeneous throughout, the whole weight is a dead weight, and consequently there is no thrust on the walls. With regard to the live load or weight which floors should be constructed to carry, some difference of opinion exists. Hurst says that for dwellings $1\frac{1}{4}$ cwt., public buildings $1\frac{1}{2}$ cwt., and warehouses and factories $2\frac{1}{2}$ cwt. are safe calculations. Others assert that for domestic buildings 1 cwt. per foot would be ample for all contingencies. An American authority states 40 lbs. is sufficient for ordinary purposes. The following table shows the results of tests of slab floors made without iron, made by Colonel Seddon, R.E., in 1874. The slabs were supported all round, and uniformly loaded with bricks.

TABLE XVI.—TESTS OF SLAB FLOORS.

No.	Length between Supports, feet.	Breadth between Supports, feet.	Thickness, feet.	Age in Days.	Breaking Weight, in cwt. per sq. ft.	Weight of Slab, in cwt. per sq. ft.	Total Breaking Weight, in cwt. per sq. ft.
1	14.5	6.75	.5	7	3	.54	3.54
2	"	"	"	14	2.76	"	3.30
3	"	"	"	21	8.88*	"	9.42*
4	"	13.5	"	7	1.07	"	1.61
5	"	6.75	"	14	2.51	"	3.05
6	"	"	"	21	2.84	"	3.38

CAST CONCRETE.—Innumerable patents have been obtained for a combination of materials, also moulds for the construction of artificial stone. Among the many that may be mentioned is Mr Ringer's system. He obtained a patent in 1832 for artificial stone formed with a lime concrete. The aggregate consisted of shingle, broken flints, masons' chippings, &c. The inventor stated that the best results were obtained by using 30 lbs. of an aggregate of a siliceous or other hard nature,

* This cracked under a load of $6\frac{1}{2}$ cwt. per square foot, but did not break under the load of 8.88 cwt. per square foot, which was the greatest load available for putting on the slab. It is probable that similar tests with slabs fixed at the edges would show an increase of strength of 25 per cent. for No. 4 slab, which is nearly square, and 30 per cent. for the remaining slabs. The slabs Nos. 1, 2, 3, and 4 were composed of 1 part of Portland cement and 4 parts of broken brick passed through a 1-inch mesh; the concrete was thoroughly rammed, and the slabs covered with water for seven days. Nos. 5 and 6 slabs were composed of 1 part of Portland cement, $\frac{3}{4}$ of a part of sand, and 3 parts of broken brick. These tests are invaluable, inasmuch that they were accurately made, and that no vested interests were concerned. Similar tests made at the present time with the improved quality of Portland cement as now made would yield much higher results.

3 lbs. powdered lime, and 18 oz. boiling water. No more of the materials were gauged at the time than were sufficient to fill one mould, as the boiling water caused the concrete to set very rapidly. The College of Surgeons in Lincoln's Inn Fields, some houses in Pall Mall, and other structures, have been erected with "Ranger's artificial stone." The material after fifty years' exposure is still sound, and shows no sign of decay. No artificial stone equals, far less excels, the strength and durability, sharpness, and evenness of Portland cement concrete. This form of artificial stone is now extensively used as a substitute for natural stone, for window heads, string courses, sills, columns, copings, keystones, and many other architectural, constructive, and decorative features. Figures, animals, bas-reliefs, capitals, panels, can be made in fine concrete with all the relief, undercut, and fine detail which distinguishes high-class from inferior work. I have produced replicas of some of Eglinton's beautiful shields and figures with all their minute details, also copies of marble figures in fine concrete. Some of these were cast in plaster piece moulds, and others in gelatine moulds. Cast work has the advantage over *in situ* work, that any defect can be detected previous to fixing. The methods of moulding and casting various works are given in the following pages.

CONCRETE DRESSINGS.—Architectural works, especially large or plain parts, are generally cast in wood moulds. If there are ornamental parts in the blocks, a combination of wood and plaster, and sometimes gelatine, is used for the moulds: wood for the main or plain parts, plaster for circular or moulded parts, and gelatine for undercut parts. The plaster or gelatine, as the case may be, is screwed on or let into rebated parts of the wood. Ornamental parts are sometimes cast separately, and then fixed on the main cast. They may also be cast separately and laid into the main mould (face inwards), and the whole is cast together in a somewhat similar way to that described for "bedded enrichments" in fibrous plaster cornices.

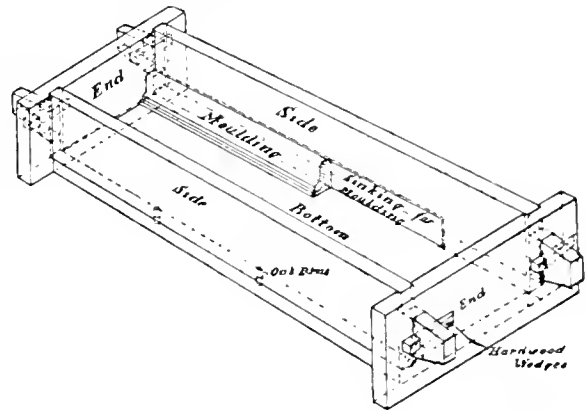

NO. 200.—WEDGE MOULD FOR CASTING BLOCKS, MOULDED LINTELS, &c.

Considerable skill and ingenuity have been displayed in the construction of wood moulds for casting concrete blocks for architectural purposes. Many methods have been employed for fixing the sides and ends together, and also to the bottom of the mould, leaving one or more parts unfixed to facilitate the release of the cast. The primitive method is to fix the various parts of the mould with screws. This is a slow and unreliable process, as the continual screwing and unscrewing for each cast soon wears the screw-holes, and the sides become loose and out of square, causing the casts to get out of their true form. Hinges, also hooks and eyes, have been used for the same purpose, but they are liable to the same defects as the screws when subjected to long use.

Thumbscrews to fit into iron sockets are also used, but they are too expensive for ordinary work, and are unsuitable for small moulds. One of the most simple and reliable methods is the "wedge mould," invented by Mr G. M. Jay, architect. It is easily made, and expeditious in working. Even after long and constant use, the casts are always accurate in form and size. The wedges and the rebated ends allow the various parts to be correctly fixed and held in position. Illustration No. 200 shows the method of construction. The various parts are named, and the sketch is self-explanatory. When the moulds are extra deep, it is necessary to make two or more sets of tenons and wedges at each angle. When there are a large number of casts required,

the mould ends are strengthened by binding the projecting ends with hoop iron. This method has been adopted for casting about 3,000 cubic feet of moulded work for mansions at West Brighton, designed by Mr Jay. Illustration No. 201 shows two useful kinds of moulds. Fig. 1 is a simple form of mould adapted for plain blocks, caps, lintels, &c. A, A are the sides, which are grooved into the ends B, B, and held together by the bolts and nuts C, C, two on each side. The bolts may be about $\frac{3}{4}$ inch diameter, with a good-sized square-head at one end, and a washer and nut at the other. This, having no bottom, is termed a bolted frame mould. It should be laid on a bench or moulding board before the cast is filled in. Fig. 2 is a section of a combined wood and plaster mould on the wedge principle, adapted for casting a string course moulding.

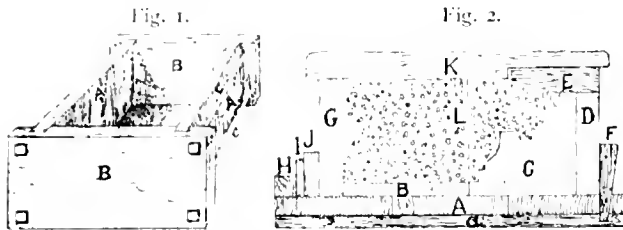

NO. 201.—FIG. 1.—BOLT MOULD FOR CASTING BLOCKS, &C.
FIG. 2.—SECTION FOR COMBINED WOOD AND PLASTER
MOULD FOR CASTING LABEL AND STRING MOULD-
INGS, &C.

This gives a point of resistance to the plaster piece C and the side board G. D is a side board on which E is screwed. E forms the sloping part of the weathering. F is one of two or more vertical wedges which hold DE in position. The sockets for the wedges F are made between the cross ledges, so that the wedge will project below the ground A. This allows the wedges to be more easily driven out when the cast is set. G is the back or plain side board. H is a fillet, $1\frac{1}{2}$ inches square, screwed on to the ground A. I and J are two folding wedges, or, in other words, wedges driven in opposite directions. These hold G in position. Two or more of these folding wedges are required, according to the length of the mould. The same remarks apply to the vertical wedges F. The latter form of wedge is only given as an alternative. The end pieces are held in position by dropping them into grooves in a similar way as shown in the previous figure,

with the exception that the grooves are cut in the sides instead of the ends. K is a gauge rule which is used for ruling the upper surface of the cast fair. This may also be done by working a straight-edge longitudinally. The dotted line at L, the concrete, indicates the wall line. The level part of the weathering up to this line, or if splayed from the outer member of this line, must be finished smooth to

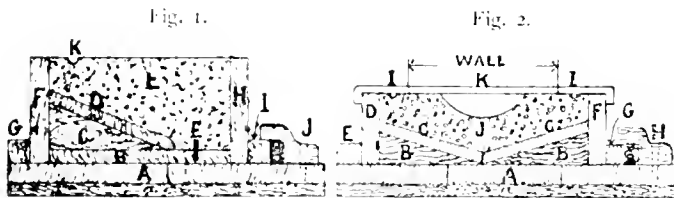

NO. 202.—FIG. 1.—SECTION OF MOULD FOR CASTING SILLS.
FIG. 2.—SECTION OF MOULD FOR CASTING COPING.

allow the water to run freely off. When the cast is set, the wedges are withdrawn, and the sides and ends released. The cast is then turned over on its back end or top side on a board, and then the plaster piece and the wood ground is taken off. If the cast is green, it should be turned over on old sacks or wet sawdust, so as to protect the arrises, and avoid fractures.

Illustration No. 202 shows a method commonly adopted for constructing moulds for sills and copings. Fig. 1 is the section of a mould for a window sill. A is the moulding board, made with two or more pieces, each $1\frac{1}{4}$ inches thick; a is one of two or more cross ledges, made with 1-inch stuff, on which A is nailed. B is the width board, made of $\frac{3}{4}$ -inch stuff, nailed on to A.

C is a block, $1\frac{1}{4}$ inches thick, which is nailed on to B. These blocks are placed about a foot apart, or so that they will carry the lining D, 1 inch thick. A groove for an iron tongue E is made in B, and a piece of thick hoop iron or iron bar is placed loosely in the groove before the cast is filled in. F is a fixed side, $1\frac{1}{4}$ inches thick. G is a fillet, $1\frac{1}{2}$ inches square, nailed on to F, and screwed on to moulding board A. H is a loose side, $1\frac{1}{4}$ inches thick, on which the fillet I is nailed. J is one of two or more clips, which turn on a screw, and are used to hold the loose side H in position. These clips are made and used in the same way as described for fibrous slabs. As compared with wedges, clips are always in position ready for use, are not liable to be mislaid, and when the fillets are fixed on to the side pieces, the clips keep the sides from rising as well as expanding. K is a throating, or water groove, which is formed in the concrete L, with a rule having a rounded edge. Two blocks, dished at the inner ends, must be fixed one at each end of the mould, so as to form a stool or bed for the superstructure. The position and form of the groove is obtained from sinkings cut in the end pieces of the mould. The end pieces are held in position by grooves cut in the side pieces in a similar way, as already described, with the exception that the grooves are cut in the side pieces instead of the end pieces. When setting out the mould, an extra length must be allowed for the side pieces for the grooves. A part of the upper surface of the cast being the part which projects beyond the line of wall must be finished fair by hand at the same time as forming the water groove. This must be done while the cast is green. When the cast is released from the mould, the iron tongue will be found firmly embedded in the concrete. Fig. 2 is a section of a wood mould adapted for casting wall copings. A is the ground of a moulding board, which may be made of $1\frac{1}{4}$ -inch stuff, and in two or more widths; a is one of two or more cross ledges, 1 inch thick, on which A is fixed. B, B are blocks about $1\frac{1}{4}$ inches thick, placed about 1 foot apart. C, C are linings, 1 inch thick, nailed to B, B. D is a fixed side, $1\frac{1}{4}$ inches thick. E is a fillet, $1\frac{1}{2}$ inches square, fixed to D, and then screwed on to A. F is a loose side, $1\frac{1}{4}$ inches thick, on which is nailed the fillet G, $1\frac{1}{2}$ inches square. This strengthens the side, and affords the fixing point for the clip H. The water grooves I, I, and the hollowed part in the middle of the concrete J (made to save materials in weight) are worked from the end pieces of the mould, which are let into the grooves, as described in the previous diagram. If the moulds are deep, wood or iron clamps may be fixed across the sides to keep them in position, as shown by K. The moulding boards in this and the previous figures, if strongly made, can be used for a variety of similar purposes. When introducing cast instead of run moulded work, I used iron and zinc plates to strengthen and make more durable plain surfaces on wood moulds; but owing to the expense and trouble in fixing the plates to the woodwork, they were abandoned, and by using a better class of wood, and indurating the surface of the mould with hot paraffin wax, sharp and clean casts were more cheaply produced. Cast-iron moulds may be used where there is a large number of casts required. They may also be advantageously used for stock designs, such as plain moulded balusters. Wood moulds are rendered more durable and impervious to wet by brushing them with hot paraffin wax, and then forcing it into the wood by ironing with a hot iron. The use of paraffin wax and oil has already been described.

There are numerous creditable examples of cast constructional and decorative concrete work to be seen in many parts of the United Kingdom, designed by some of the leading London and provincial architects.

Madame Tussaud's Exhibition is mainly constructed of red concrete dressings. The whole of the exterior dressings and interior constructional work of Upton Church, Romford Road, Essex, is composed of red concrete blocks; and the chancel and transept arches, with the clerestory windows,

are in the same material. The majority of the bosses were carved *in situ*. Blocks for the bosses were cast and carved as soon as fixed, while the blocks were green. A few bosses, modelled by my son, J. Millar, were used. Messrs Banks & Townsend were the architects. The work was done under my supervision. The façade of the Colosseum at Dalston, London, is decorated with concrete blocks enriched with elephants', horses', and lions' heads, and figure panels, &c., all cast in a dark red colour. The work was carried out by Wilkes' Metallic Concrete Company, under my supervision. I am also responsible for the major portion of the modelling. Mr A. Brandreath was the architect.

MOULDINGS CAST "IN SITU."—Casting cornices, copings, &c., *in situ* a process originally introduced by the author is now frequently employed for concrete. Mr T. Potter, in his book, "Concrete: Its Use in Building," says: "The *in situ* system of performing this class of work was introduced by Mr Millar, and carried out to a large extent on the Redcliffe estate, West Brompton,

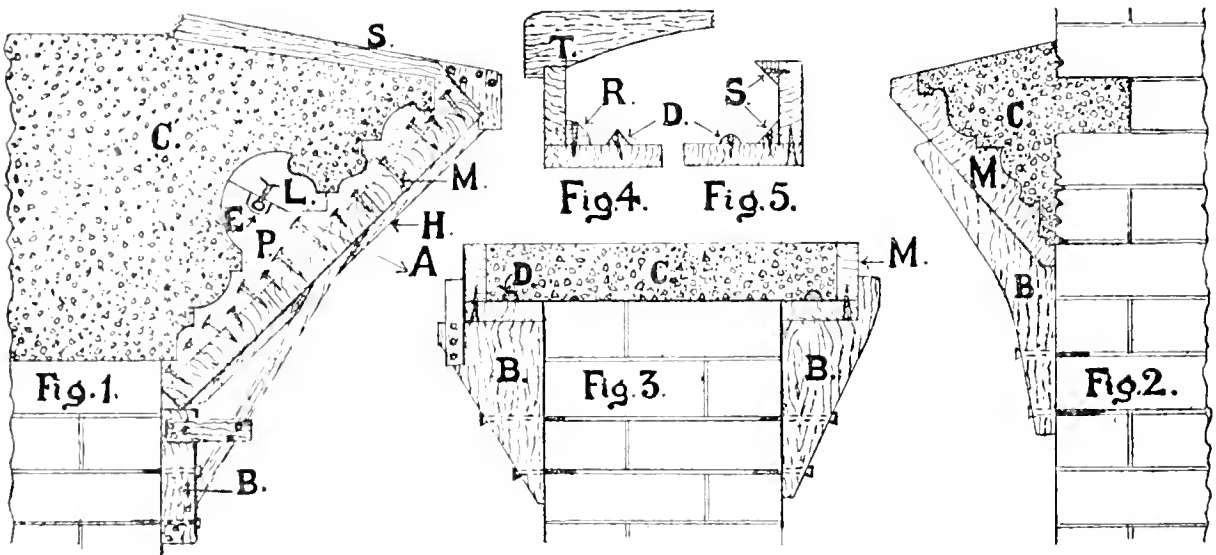

No. 203.—SECTION OF MOULDS FOR CASTING CONCRETE MOULDING "IN SITU."

Fig. 1.—Combined Plaster and Wood Moulds for a Cornice. Fig. 2.—Wood Mould for String Mouldings. Fig. 3.—Mould for Coping. Fig. 4.—Mould for Saddle-back Coping. Fig. 5.—Mould for Coping with Chamfered Angles.

twenty to twenty-five years ago, and is probably nearly or quite the earliest attempt of the kind in this country." The advantages of this system over shop cast work are, that the work is readily done, and the cartage or moving from the workshop to the building, and the fixing, are dispensed with.

Illustration No. 203 shows the method of constructing and fixing various kinds of casting moulds for *in situ* work.

Fig. 1 shows the section of a cornice, casting mould, and supporting bracket. Wood moulds are generally used for small or plain mouldings, but where the profile is undercut or of an intricate nature, a plaster mould is preferable, as it is easier and cheaper to construct a plaster mould than cut the irons which are necessary for a wood mould for a special design. Fibrous plaster moulds may be used for this class of work, but to illustrate another method a combined wood and plaster mould is given. M is a moulding board used to strengthen the plaster profile, and on which it is run. The board may be made in two or more pieces, each about 1 inch thick, and in width according to the

depth of the moulding, and in length as required, the whole being held together by cleats H, which are nailed about 3 or 4 feet apart. Broad-headed nails are then driven in at random, leaving the heads projecting, to give a key for the plaster profile P. The profile is then run with a reverse running mould. It will be seen that this profile is undercut, therefore a loose piece L is required to enable the mould to draw off the moulding. The reverse mould and loose piece are constructed in the same way as described under the heading of "Reverse Mouldings." It may be here remarked that it is sometimes useful to have an "eye" inserted in the loose piece to give a better hold for the fingers when taking the loose piece off the moulding. The eyes are made by twisting a piece of strong wire round the handle of a tool brush, leaving one end in the form of a ring, and the other bent outwards so as to form a key. The eyes are fixed about 3 or 4 feet apart, the fixing being done by cutting a hole in the loose piece and bedding the shank of the eye with plaster, and then cutting a slot in the main part of the mould to receive the ring of the eye as shown at E. The mould is held in position by the bracket B, fixed 4 or 5 feet apart. The mould is further secured by the stay S; the other or inner end of the stay is fixed on to the main wall. It will be understood that a plaster mould for this purpose should be dry and hard, and then well seasoned with linseed oil, or with a hot solution of paraffin wax. After the mould is fixed in position it is oiled, and then the concrete C is filled in, taking care that the surface of the mould is first covered with a thin coat of neat cement. The mould may be oiled with paraffin oil; but if the mould is inclined to "stick," oil it with "chalk oil," *i.e.*, paraffin oil and French chalk, about the consistency of cream.

When the concrete is set, the brackets are removed, and the mould taken off. The mould in this case would draw in the line of the arrow A. The loose piece is then taken off. It is here that the use of the eyes will be found. Before removing the brackets it is advisable to prop the mould, in case it may drop off and break the fragile portions of the mould or parts of the cornice. A heavy mould hanging in this position, especially if the profile is flat, or in good working order, is apt to drop, hence the necessity of props. If the mould clings, or, as more generally called, "sticks fast," gentle tapping with a heavy hammer will ease or spring it, and allow it to be taken off. A heavy hammer is more effective in making the mould spring than a light hammer, as the force required for a light hammer is apt to injure the mould. This is why a heavy hammer with a flat head is best for plaster piece moulding.

Fig. 2 is the section of a string moulding with the casting mould and bracket. A chase is formed in the brickwork to allow it to bond, and the joints and the surface of the brickwork are cut out and hacked to give a further key to the moulding. M is the mould (in this case made of wood). The profile is drawn without any undercut parts, so as to allow the mould to draw off in one piece. B is the bracket, and C is the concrete. The same directions for casting Fig. 1 apply to this and the other mouldings here shown. A drip member, as shown at the top member of both cornices, is generally used for exterior mouldings, to prevent the water running over the wall surface.

Fig. 3 is the section of a wall coping and the casting moulds. M is the mould, a similar one being used for the other side. A mould for this purpose is best formed with flooring boards about 1 inch thick, and fixing them together as shown. The drip D is readily formed by sawing an inch bead through the centre, and nailing it on the bottom. Two forms of brackets, B and B, are here given. One is cut out of the solid, and the other made of two pieces of wood nailed together.

Fig. 4 is the section of a casting mould for a saddle-back coping. R is a quarter-round piece of wood fixed in the angle of the mould to form a cavetto, which is sometimes used in copings. D is an angular-shaped drip, sometimes used in place of a circular one. T is part of a template used for forming the saddle-back of the coping.

Fig. 5 is the section of a mould for a coping with splayed or chamfered angles. *s* is a triangular strip of wood fixed in the angle and the top of the mould to form the splay's, and *D* is a circular drip.

Concrete mouldings that are deeply undercut or intricate in profile may be cast *in situ* by the use of the "Waste Mould Process," as described in Chapter IX.

MODELLING IN FINE CONCRETE.—Figures of the human and animal form, also emblems, trade signs, and buildings, are now being made in fine concrete. The work may be executed *in situ*, or in the modelling shop, and then fixed in position. For important works a plaster model is made first, and then placed in position, so as to judge of the effect before committing it to the permanent material. For this process the model is first modelled in clay, and then it is waste-moulded, and a plaster cast obtained. After the model is approved it is moulded, and then cast in the fine concrete. The material is composed of Portland cement, and a light, but strong, aggregate; and the cast is made in a similar way to that described for casting vases. The material may be coloured as required to suit the subject. The general method of executing figures "on the round" in fine concrete or Portland cement is to model the figure direct in the cement on an iron frame, and then to fix it in its permanent position. This is effected by first making a full-sized sketch of the proposed figure, then setting out on this the form of the necessary ironwork to serve as frame or skeleton to form an internal support. This iron frame also forms a core to enable the figure to be made hollow, and serve as a permanent support for thin parts and extremities of the figure. The quantity, size, and form of the iron frame is regulated by the size, form, and position of the figure. For instance, if the model of a full-size lion is required, first make a rectangular frame to suit the feet of the lion and the base on which the figure stands. The base frame is made of iron bars, $1\frac{1}{2}$ inches wide by $\frac{1}{4}$ inch thick, fixed on edge. Then set out four leg-irons, and connect them on the base frame, and then set out one or two body-irons, and connect them with the leg-irons. After this set out a looped piece to fit the contour of the neck and head, and fix it to the body-iron. Now set out the tail-iron. This is best formed with an iron pipe, and it should be made to screw on to the body-iron. This allows the tail to be unscrewed when the model is finished, and screwed on after the model is fixed in position, thus enabling the model to be more freely handled, and with less risk of breakage when moving and fixing in its permanent position.

Having made the frame, place it on a stout modelling board, keeping the base frame from 1 to 3 inches above the board, according to the depth of the base; the frame being temporarily supported with four pieces of brick or stone. This is done to allow the base frame to be enveloped with concrete. This done, fix wood rules, cut to the depth of the base, on the board, so as to form a fence on all sides of the base. Then fill in the base with concrete; and when this is set, proceed with the coring out, so as to obtain a hollow model.

In order to decrease the weight of concrete figures "on the round," and to enable them to be more easily handled and hoisted when fixing them in their permanent positions, they should be made hollow. This is effected by making a rough skeleton frame with hoop-iron, or with wire-netting, for the body, neck, and head, and other thick parts. This metal skeleton must be built on and securely fixed to the main iron frame. The whole, or parts of the figure, may also be cored out with shavings or tow, and held in position with tar bands or canvas strips, dipped in plaster. Tow is an excellent material for forming cores. By making up the inner parts with dry tow, and then dipping tow in plaster for the outside coat, the core can be made to any desired shape, and also leave the necessary thickness for the concrete. To prevent the material slipping down by its own weight, pieces of iron or wood, in the form of crosses, are fastened with copper wire or tar rope to the iron rods, which are used as single supports. These iron or wood pieces must be fixed in

all directions, and in such a way that the material is held up by them. For small extremities, such as fingers of human figures, beaks of birds, fins of fishes, horns and tails of animals, iron rods should be fixed on the main frame, and the parts to be covered with cement must be notched or bound at intervals with copper wire or tar rope. The distance between the core and the finished face of the figure is of course the actual thickness of the model. This thickness may vary from 1 inch to 3 inches, or even 4 inches at some parts. An average thickness of 2 inches will be sufficient to give the requisite strength.

When the core is made, cover it with a coat of Portland cement and old lime putty, in the proportion of 3 of the former to 1 of the latter, and add sufficient tow or hair to give tenacity. If there are open spaces in the skeleton ironwork, bridge them over with bits of tiles and cement. The whole surface, after being coated, must be well scratched with a nail, to give a key for the roughing-out coat. This scratch-coat must be allowed to set before proceeding with the actual modelling. The stuff for roughing out is composed of 2 parts of Portland cement and 1 part of fine aggregate. Crushed bricks, stone, or pottery-ware passed through a sieve having a $\frac{1}{8}$ -inch mesh may be used as aggregates. The finishing stuff is composed of fine sifted Portland cement. The addition of a fifth part of old lime putty to the cement makes the stuff more mellow, and works freer and sweeter. The modelling is done as described for *in situ* work. The finishing coat can be coloured to any desired tint, as already described.

Among the many recent examples of this class of work may be mentioned a deer which stands on the Buccleuch Memorial at Hawick, modelled by my nephew, W. Brown, of Edinburgh. Natural horns or antlers were used for this deer. During the last decade numerous symbolic figures as signs for London public-houses have been executed in fine concrete or Portland cement. A fine example of this class of work is a bull nearly life-size for "The Black Bull" at Stratford, modelled by Gilbert Seale. Other examples are a swan for "The White Swan," Fulham, modelled by F. Blount; also a cock for "The Cock" at Fulham, modelled by W. Batchelor, shop-foreman for J. Bickley; and a lion—over life-size—for "The Red Lion," Fulham, modelled by the author in 1890 for J. H. Squires, Esq.

CONCRETE FOUNTAINS.—Fine concrete is an excellent material for the construction of fountains. It is obvious that a vast amount of cutting and consequent waste of material is involved in the executing of fountains, "on the round," when natural stone is employed. Saving of material, and a corresponding reduction in the cost, is effected by use of a material that can be easily cast, and is at the same time durable and impervious. These qualities combined are found in artificial stone composed of fine concrete. Being readily made in large blocks (any sized basin can be made in one piece), there is no jointing required, as is the case with terra-cotta, which is another form of artificial stone. Fountains composed of fine concrete are made in a similar way to that described for making and casting vases. An elaborate fountain which was on view at the Building Trades' Exhibition, London, 1887, was about 9 feet high, and 6 feet in diameter. It was enriched with cupids, dolphins, shells, water lilies, and leaf foliage. The whole was cast in fine red concrete. It was modelled by F. Blount, and moulded by W. Flavell.

CONCRETE TANKS.—Concrete tanks to contain water, and for a variety of manufacturing purposes, are now largely in use. They are strong and durable, and having hard smooth surfaces, they are easily washed and kept clean. Being impervious to vermin, damp, and atmospheric influences, they are the coolest and most sanitary water cisterns that can be used. Cattle troughs are best made in concrete. I have used concrete tanks as water and silicate baths for indurating concrete casts, and during their constant use for over a decade no signs of cracks or damp were

ever visible. They were made in one piece, varying in size from 6 feet up to 18 feet long, 3 feet to 7 feet wide, 2 feet 6 inches to 4 feet high, and from 3 to 4½ inches thick. Some were cast, but the large ones were made *in situ*. The method of construction for *in situ* work being simple and expeditious, the total cost is small. For a tank 9 feet long, 4 feet 6 inches wide, 2 feet 6 inches high, and 3½ inches thick, first frame up wood sides and ends to the above length, width, and height, then make inside boards, the lengths and widths being the same as above, less the tank thickness, and the heights less the bottom thickness. The sides and ends are hung by means of cross battens laid on the upper edges of the outside framing, and kept in position with inside stays. This leaves an open and continuous space at the sides, ends, and bottom. The constructive materials are 1 part of Portland cement and 2 of fine slag or granite, gauged stiff, and laid over the bottom. Next, the open sides and ends are filled up, taking great care that the whole mass is thoroughly consolidated by ramming. The stuff for the sides and ends should be laid in layers from 6 to 8 inches deep, each layer being well rammed before the next is laid.

The angles are strengthened by inserting angle irons during the process of filling in. As soon as the concrete is set the inner boards are removed, and if the surface is smooth or dry, it must be keyed with a coarse drag or a sharp hand pick. It is then swept and wetted to cleanse it and stop the suction, so as to ensure perfect cohesion, and allow the final coat to retain its moisture during the process of trowelling and the stuff setting.

The finishing coat is composed of neat cement, the finer ground the better, as percolation through concrete made with a finely ground cement is less liable than when made with a coarsely ground cement.

The final coat is laid about ¼ inch thick, and preceded by brushing the surface with liquid cement to fill up all crevices, and afford better adhesion between the surface and the final coat. When the stuff is firm, it is well trowelled to a fine and close surface. The outer boards are then removed, and the surface finished in a similar way.

CONCRETE SINKS.—Concrete sinks can be made to any desired size or form. They are cast in wood or plaster moulds, and are composed of 1 part of Portland cement to 2 parts of fine crushed granite or other hard aggregate. They are made with rebated holes for traps. The ordinary sizes are as follows:—2 feet 6 inches by 1 foot 8 inches; 2 feet 9 inches by 1 foot 8 inches; and 3 feet by 2 feet, all 6 inches deep, and from 2 to 3 inches thick.

GARDEN EDGING.—Plain and ornamented edgings are now made in concrete. They are made in various lengths. The most useful size is 3 feet long, 6 inches deep, and 2 inches thick. They can be made to any curve, and tinted to any shade.

CONCRETE VASES.—During the last half-century thousands of vases, composed of fine concrete—commonly called "artificial stone"—have been used for the decoration of buildings and practical use in gardens, conservatories, &c. For vases that are cast in sections the thickness of large and open parts, such as the "body," are regulated by means of a plaster core, which is placed in the open mould. The contour of the core must be so arranged that the cast will draw from the core, or *à la versé*. For some forms of vases, the core must be made in pieces similar to a piece mould. The method of making, moulding, and casting—the latter by the aid of a template instead of a core—is described in Chapter IX.

CONCRETE CHIMNEY-PIECES.—Chimney-pieces of all sizes and shapes are now extensively made in fine concrete. They are generally made in wood moulds, plaster moulds being let in the main mould for ornamental parts. They are often made in coloured concrete.

COLOURED CONCRETE.—Concrete casts, also work laid *in situ*, can be coloured to imitate any

natural stone. This is effected by mixing mineral oxides of the required colour with the cement used for the surface coat. The colour coat should not exceed $\frac{1}{4}$ inch in thickness, as oxides are too expensive to use for the entire thickness of the cast. The quantity of oxide to be added to the cement depends upon the strength of the oxide. Some are much stronger than others. Five per cent. of a strong oxide will impart a close resemblance of the desired colour to the concrete, but a weak oxide will require from 10 to 15 per cent., and even 20 per cent., to obtain the same colour. Some of the red oxides range in colour from scarlet or Turkey red, gradually deepening to chocolate. Some oxides contain 95 per cent. of pure ferric oxide, which is made from copperas, or, scientifically speaking, sulphate of iron. This is a by-product, and is frequently evolved from waste acid liquors at tinplate works, and is obtained in large quantities from South Wales. This kind of oxide is far more suitable for colouring concrete than ochres and most of the earthy oxides. Earthy colours, like Venetian red and umber, soon fade and have a sickly appearance. The oxides should be intimately mixed with the cement in a dry state before it is gauged. The mixing is generally done by hand, but better results are obtained by the use of a grinding machine. It is a safe plan to try various proportions of colour and cement and gauge small parts, and when set and dry select those most suitable for the desired purpose. All cast work, as soon as extracted from the moulds, should be examined, and any blubs stopped and chipped parts or other minor defects made good while the work is moist or green, using neat cement and colours in the same proportion as used for the surface stuff. Coloured surfaces may be greatly improved by brushing the cast as soon as set with a solution of the same colour as used for the surface coat. A colour solution, made by mixing the colour with water and a solution of alum, is very useful for colouring Portland cement, with or without sand. If this colouring solution is brushed over the surface while it is moist or semi-dry, a good standing colour can be obtained without mixing colour with dry cement. This method will be found useful for *sgraffitto*, &c.

A novel and colour-saving method, for colouring the upper surfaces of slabs or other flat casts, is effected by first filling in the mould in the usual way, then placing the coloured cement in a dry state in a hand sieve, and then violently shaking or tapping the sides of the sieve, so as to sprinkle the coloured cement uniformly over the surface until it is nearly $\frac{1}{16}$ inch thick. The surface is then trowelled in the usual way. The sprinkling must be done as soon as the main body of the stuff is ruled off, so as to obtain a homogeneous body. Another and a novel method which may be advantageously employed for finishing slab or other large surfaces in a mould is as follows:—A fine finished face is more readily obtained by using a smoothing knife (for brevity termed a "shaver") than by a trowel. A shaver is a piece of polished steel about 3 inches wide and $\frac{3}{8}$ inch thick, the length being regulated according to the width of the mould, and allowing about 8 inches at each end for handles. For instance, for a slab 2 feet wide, the shaver should be 3 feet long. This allows 2 feet for the surface of the cast, 3 inches to bear on the rims of the mould, each $1\frac{1}{2}$ inches wide; 8 inches for the handles, each 4 inches long; and 1 inch for play. One edge or side is cut to an angle of 45° , so as to form a cutting edge. The method of filling in, colouring, and finishing the surface of the slab is as follows:—First fill in the mould with the concrete, ramming and beating it as already described, until the stuff is about $\frac{1}{16}$ inch above the mould rims, then clean off the stuff on the rims with a wood template (rebated to fit the width of the rims), and lay the shaver flat on the rims, keeping the cutting edge outwards, and then push it forward, keeping it flat on the rims, so as to shave off the superfluous stuff. This done, sprinkle the coloured cement, with the aid of a sieve, until about $\frac{1}{16}$ inch thick; then clean the rims again, and pass the shaver forwards and backwards

twice or thrice, which will leave a straight, smooth, and uniform-coloured surface. This method effects a considerable saving in the amount of oxide and of time. The thickness of the colouring stratum is reduced mechanically to the minimum about $\frac{1}{2}$ inch, which is all sufficient for colouring purposes where the surface is not subjected to frictional wear.

As already mentioned, bullocks' blood mixed with cement gives a near resemblance to red brick, but it is not a desirable material to work with, and the same effect can be obtained by the use of red oxides. Red sand, brick, and stone, all finely ground, have been employed for colouring cement surfaces, but if too fine or in large quantities they weaken the surface; and if coarse-grained they possess little colouring effect, because the particles are liable to show singly, causing a spotty appearance, or the cement entirely covers the surface of each particle of sand. Powdered glass, marble, flint, alabaster, metal filings, and mineral colouring can be effectively employed for colouring concrete surfaces by mixing with the cement used for the surface coat. The surface is improved by rubbing and stoning, also polishing, after the work is dry. Mr Lascelles obtained a patent for this object in 1887. Other methods and quantities of colours for colouring Portland cement surfaces are given on page 190.

FIXING BLOCKS.—Concrete fixing blocks do not shrink, warp, or rot. Consequently they are superior to wood fillets, &c. They are principally used in concrete floors, stair landings, and walls, as bearings and fixing points for wire-lathing and fibrous plaster work. Floor boards may also be fixed to them. They are also built into brick walls for similar purposes, as well as for external wall tilings. For ceilings, stair soffits, and landings, the blocks are laid on the centrings where required, and permanently secured by laying concrete between and over them. For bearings and fixing flooring boards, they are secured flush with or above the upper surface of concrete, as required. Fixing blocks are made with splayed sides, so as to give them a dovetailed section, and make the key when embedded with concrete. To increase the keying powers the sides are sometimes grooved. They are made in various sizes from 1 to 3 feet long, 2 to 3 inches thick, 2 to 3 inches wide at the top, and 3 to 4 inches wide at the bottom. These blocks are cast in wood, iron, or plaster moulds, and are composed of 1 part of Portland cement to 5 of fine crushed coke-breeze. The breeze and cement are sometimes ground together in a pug-mill.

LINTELS.—Concrete lintels and beams are fast superseding those made of stone and wood. Lintels are generally cast and then fixed. A mould for casting lintels is shown on page 506.

CONCRETE WALLS.—Many ingenious plans have been introduced as substitutes for wood framing for retaining concrete while constructing walls and partitions. The most simple method is as follows:—Cast a number of concrete angle slabs with an **L** section, and place them level in contrary directions thus **┐ ┌**, spaced to the width of the proposed partition or wall until the desired length of wall is completed, and fill in the openings with rough concrete. When set, place another row on this (taking care to break the joints by overlapping), and so on, until the desired height is obtained. Concrete for walls formed *in situ* should be deposited in layers, taking care that each layer is thoroughly rammed and keyed, as described under the heading of "Ramming." A suitable finish for ordinary purposes, for rough walls built *in situ*, may be obtained by "rough trowelling." This is done by first gauging 1 part of Portland cement, 1 part of old lime putty, and 2 parts of sand. The adding of lime renders the stuff more plastic and easy to work, without decreasing the impermeability of the work. This "limed cement" is applied with a hand-float, and is thoroughly worked into the crevices of the concrete, but leaving no body on the surface. The surface is then finished by brushing with a wet stock-brush. The walls should be well wetted before the stuff is applied.

STRONG-ROOMS.—Concrete is frequently employed in the construction of strong-rooms that are situated underground, and are rendered damp proof as well as burglar proof, which is useful for the storage of documents. An excellent example of this class of work can be seen at the Credit Lyonnais, London, executed by T. W. Potts, who has executed many concrete works.

CONCRETE COFFINS AND CEMENTATION.—The great improvements in the manufacture of Portland cement during the last decade has so cheapened and improved the quality as to bring it more and more to the front as one of the most useful and important materials for a variety of purposes. One of the latest uses found for it is in the construction of coffins, by the author, whose invented and registered idea was that such a coffin, made of specially prepared metallic concrete, would be impermeable, and practically indestructible, and that it would obviate the danger of spreading the poisons of disease, by preventing the escape of noxious gases. The lid having a strong piece of plate glass embedded in the concrete, and directly over the face, enabled the mourners to see the features of the departed. The edge of the open coffin had a sunk groove, and the lid a corresponding projection, only smaller, to allow for a coat of fine cement. When the joints were bedded and pressed together until the excess cement oozed out, the coffin was hermetically sealed. The coffin could be left uncovered by cement for identification, and so that friends could view it until the time of removal to the cemetery. The face could then be covered with quick-setting cement, which, joining with the other portion of cement, would permanently embalm the body, which would further be protected by fixing the lid in a similar way. If the properties of this class of coffin are taken into consideration, the expense will be comparatively less than that of wood. If expense is not a special consideration, the coffin can be enriched with armorial bearings or other devices. The concrete may also be polished like real granite. One objection was raised as to the weight, but the old stone coffins and those of oak lined with lead were also heavy. Besides, the weight would be a protection against body-snatchers; and bearing in mind that a coffin is only moved about once in a lifetime, or rather at death, the question of weight is unimportant. Cementation, from a sanitary point of view, would be equal if not superior to cremation. In case of an epidemic, the coffins could be cemented at once, and stacked in the cemetery until graves or vaults were prepared for them. It may be safely said that it is a clean, safe, effectual, rapid, and sanitary method of disposing of the dead. As this coffin was exhibited for the first time at the Building Trades' Exhibition in the jubilee year 1887, and being requested by Mr T. Grover, the Chairman of the Patent Paving and Eureka Concrete Company, to provide a novel advertisement for the Company, for which I was then acting as manager, I named it "The Jubilee Coffin." If their manufacture should not cause any great amount of extra employment for plasterers, the latter can at least make their own coffins, in frosty weather, when most works are stopped, and they could use them as baths during their lifetime.

STONETTE.—Stonette is a composition of Portland cement and fine aggregate, to imitate any kind of stone, and so made that it can be carved the same as natural stone. The Portland cement must be thoroughly air-slaked, finely sifted, and gauged with the natural aggregate in the proportion of 2 of cement to 7 of aggregate. The aggregate is composed of finely crushed natural stone, the same as that to be imitated. This should be passed through a fine sieve. It is necessary, when imitating some stones, to add a small portion of oxide to counteract the colour of the cement. If a very white stone is being imitated, the addition of a small proportion of whiting or French chalk, or well-slaked white limestone, is necessary to obtain the desired colour. The material should be gauged stiff, and then well rammed into the mould. The carving is best done while the cast blocks are green.

TILE FIXING.—Tile fixing is in some districts a separate branch of the building trade, but it is generally recruited from the ranks of plasterers, and in some districts it is done by plasterers. As regards the process of placing the tiles, it is best to work from the centre of the space, and if the design be intricate, to lay out a portion of the pavement according to the plan, upon a smooth floor, fitting the tiles together as they are to be laid. Lines being stretched over the foundation at right angles, the fixing may proceed, both the tiles and the foundation being previously soaked in cold water, to prevent the too rapid drying of the cement, and to secure better adhesion. The border should be left until the last. Its position and that of the tiles are to be obtained from the drawing, or by measuring the tiles when laid loosely upon the floor. The cement for fixing should be mixed thin, in small quantities, and without sand. It is best to float the tiles to their places, so as to exclude air, and fill the space between them and the foundation. For fixing tiles in grate cheeks, sides and backs of fireplaces, &c., equal parts of sand, plaster, and hair mortar may be used. These materials are sometimes mixed with hot glue to the consistency of mortar. The tiles should be well soaked in warm water. Keen's or other white cements are used as fixing materials for wall tiles, neat Portland cement (very often killed) being generally used for floor work. Tiles may be cut in the following manner:—Draw a line with a pencil or sharp point where the break is desired, then placing the tile on a form board, or embedding it in sand on a flag-stone, tap it moderately with a sharp chisel and a hammer along the line, up and down, or scratch it with a file. The tile may then be broken in the hand by a gentle blow at the back. The edges, if required, may be smoothed by grinding or by rubbing with sand and water on a flat stone. Tiles may also be sawn to any desired size. Cement should not be allowed to harden upon the surface of the tile if it can be prevented, as it is difficult to remove it after it has set. Stains or dirt adhering to tiles may be removed by wetting with dilute muriatic acid ("spirits of salts"), care being taken that the acid is all wiped off, and, after washing, the superfluous moisture must be wiped off with a clean dry cloth. In order to obtain a sound and straight foundation, which is imperative for good permanent tile fixing, the substratum, whether on walls or floors, should be composed of Portland cement gauged with sharp sand or similar aggregate in proportion of 1 of the former to 3 of the latter. The surface must be ruled fair and left rough, so as to form a fair bed and key for the fixing materials and tiles.

PATENT NON-SLIPPERY STEPS.—A novel and effective method of rendering concrete steps and landings non-slippery has been recently patented by Messrs Burness & Son, plasterers, Montrose. Indiarubber cubes, about half an inch in diameter, and a screw-shaped sinking on the side, are inserted in the moist concrete until the tops are nearly flush with the concrete surface. For cast steps the cubes are temporarily fixed on the face of the mould, and then the concrete is laid in the usual way. When the concrete is set a corresponding screw cut is formed in the side of the concrete cube holes. The cubes can be extracted or raised by simply unscrewing them with a two-pronged fork. When the cubes wear below the concrete surface they are raised for further use by screwing them up, and so on until they are finally worn out, after which they are replaced by screwing in new ones. These rubber cubes, while affording a sure foothold, also decrease the wear of the concrete surface, besides providing a soft tread and a noiseless traffic. The cubes are placed in two or more rows, and from two to three inches apart. Messrs W. B. Wilkinson & Co., Newcastle and London, are the agents for the rubber screw cubes.

CHAPTER XX.

RUDIMENTARY GEOMETRY AND ARCHITECTURE.

PRACTICAL GEOMETRY AS APPLIED TO PLASTER WORK.—TO SET OUT A TEMPLATE FOR A FLAT ARCH—TO CONSTRUCT A TEMPLATE WITHOUT A RADIUS—TO FIND THE CENTRE OF AN ARCH—TO DESCRIBE AN ELLIPSE—TO DESCRIBE A FLAT ELLIPSE—TO SET OUT A FLAT ARCH—TO FORM AN OVAL FROM CIRCLES—TO FORM AN OCTAGON—TO SET OUT ARCHES: FLAT-POINTED ARCH, SEMICIRCULAR ARCH, FLAT ARCH—TO DESCRIBE A GOTHIC ARCH—RADIUS OF SEGMENTS BY FIGURES—THE ELEMENTS OF ARCHITECTURE—MOULDINGS—TO DESCRIBE ROMAN AND GRECIAN MOULDINGS—THE GRECIAN AND ROMAN ORDERS: DORIC, TUSCAN, IONIC, CORINTHIAN, AND COMPOSITE—HEIGHTS OF COLUMNS—DIMINUTION OF COLUMNS—PROPORTION OF ENTABLATURES—PILASTERS—IMPOST AND ARCHIVOLT MOULDINGS—BALUSTERS—SETTING OUT BALUSTRADES—COPYING MOULDINGS.

PRACTICAL GEOMETRY AS APPLIED TO PLASTER WORK.—Geometry is an important factor in most building processes. No part of a building or of a drawing can be laid down or properly understood without a knowledge of geometry, nor can any mechanical branch of the building department be constructed without some assistance from this branch of science. I have seen men unacquainted with geometry spend several hours in the solution of problems which could have been solved in about a quarter of the time if geometry had been employed. It is not difficult to acquire a knowledge of this science; indeed, great progress in its study could be made by simply employing the time frequently wasted in the endeavour to solve a simple problem in a roundabout way. As a matter of fact, its principles are frequently used unconsciously by some workmen, and though forming the basis of most designs, its utility is not fully acknowledged. There are so many good and cheap works on the subject that it is only necessary to give a few examples, which bear upon almost everyday work of the plasterer and artificial stone manufacturer. The examples here given will be found useful when setting out artificial stone work, cement façades, and model making; also for "solid" and fibrous plaster work.

Illustration No. 204 elucidates the method of setting out ovals, arches, octagons, and templates, by lines.

TO SET OUT A TEMPLATE FOR A FLAT ARCH.—Fig. 1 shows the method of forming a curved line without using a radius, which may be used for setting out a template to run a moulding on a flat arch, or for forming centring for concrete work. The span and rise of arch being given, first divide half the span into six or more equal parts, divide the rise into the same number of parts, and number all as shown; then draw lines from 1 to 1, 2 to 2, 3 to 3, 4 to 4, 5 to 5, and 6 to 6, and their intersections will give the desired curve. Repeat the same process for the other half.

TO CONSTRUCT A TEMPLATE WITHOUT A RADIUS (Fig. 2).—Suppose the span of this curve to be 40 feet long from A to B, and it is required to raise it 1 foot 6 inches at C. Draw a line from C to B, divide this line into two equal parts, and at the division 1 raise a line at right angles to CB one-fourth of the height of the proposed rise, which in this case would be $4\frac{1}{2}$ inches; then bisect the line from 1 to B and from 1 to C, which will give the points 2 and 3, raise lines from these

points one-fourth of the last division, which will be 1½ inches. The same process is repeated until there are sufficient points when connected to form a regular curve.

TO FIND THE CENTRE Fig. 3.—Take *AB* as the span of an arch, and *D* and *C* its perpendicular height. The straight lines passing from *A* to *C* and *C* to *B* are called chords. To find the centre, first draw the chords from the springing *B* to the centre *C*, and *A* *C*. Then bisect the chords by the perpendicular lines *PE* and *PF*. The point where they intersect will be the centre from which to describe the arch. For cement or concrete work the joints are set out by the same process.

TO CONSTRUCT AN ELLIPSE Fig. 4.—Take *AB* as the span of the arch, divide the base line *AB* into three equal parts; on *C* as a centre, with the radius *CD*, describe the arch *BD*, and on *E* as a centre, with radius *EE*, describe the arch *AE*. Then by the same rule as for Fig. 3 find the centre *P*, and on *P* as a centre join *ED*. From the point *E* get the first two joints *G* *F*, and from the point *C* get the first two joints *D* *H*, and from the point *P* get the remainder of the joints.

TO CONSTRUCT A FLAT ELLIPSE Fig. 5.—Take *AB* as the span of the arch, divide the base line into four equal parts; on *C* as a centre describe the arc *DB*, and on *E* as a centre describe

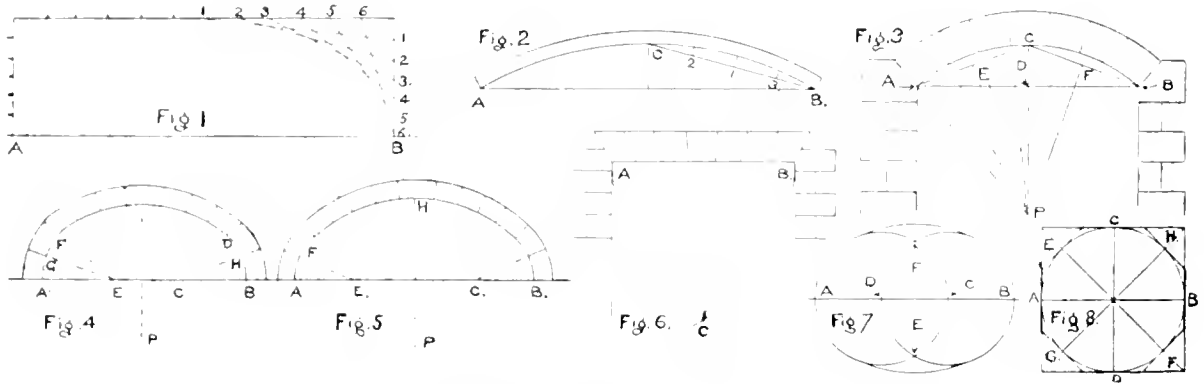

NO. 204.—SETTING OUT OVALS, ARCHES, OCTAGONS, AND TEMPLATES.

the arc *AE*, from *E* to *C* on the base line. Then by the same rule as before find the centre *P*. On *P* as a centre, with the radius *PH*, join the arc *ED*; on *C* as a centre get the first joint *D*, and on the point *E* get the first joint *F*, and from the point *P* get the remainder of the joints.

TO CONSTRUCT A FLAT ARCH Fig. 6).—Divide the span *AB* into any required number of equal parts, and under *AB* form the equilateral triangle *ABC*, then *C* will be the point from which the joints of the arch stones must be drawn.

TO FORM AN OVAL FROM CIRCLES Fig. 7.—First draw the centre line *AB*, then divide the line into three equal parts, and from *D* and *C* as centres describe two circles, the one intersecting the centre of the other as shown. From the intersection of the circle at *E* and *F* connect the two circles, thus completing the oval.

TO FORM AN OCTAGON Fig. 8.—First draw the centre line *AB*, then the centre line *CD* square to *AB*; form the four outer lines parallel to the two centre lines, then form the two diagonal lines *EG* and *GH*. From the centre describe the circle *ABCD*, then apply a set square to the lines *CD* and form one cant, reverse the square to form the others, touching the circle each time. The cants will then form a true octagon.

Another way is to first form a square (made to the desired size of octagon), and from each angle

draw a segment whose arc will touch the centre of the square, and from the termination of each curve draw angular lines, and then erase the angle lines of the square and the circular lines, thus leaving the desired octagon.

ARCHES.—The method of setting out the various arches shown on illustration No. 205 will be of service when constructing artificial stone work, also for working fibrous plaster, or Portland cement façades.

FLAT-POINTED ARCH (Fig. 1.—Draw the line A to B at the springing of the arch, divide this into four equal parts (1, 2, 3, 4). Take 1 and 3 as centres, and describe the springing arcs at D and D; a section of each will form the haunch of the arch. Draw the lines C C from D and D through the points at 1 and 3 towards G and G, at an angle of 45°. Take 3 parts of A to B as a radius, and from the point G strike E the upper part of the arch from the point at D to F. Repeat the same process for the other side of arch. The same centres and radius to scale are used when running mouldings on this form of arch. The moulding may also be run from a template. In this case the template can be set out by the method given for setting out the arch.

SEMICIRCULAR ARCH.—Fig. 2 illustrates a semicircular or half-round arch, and the various

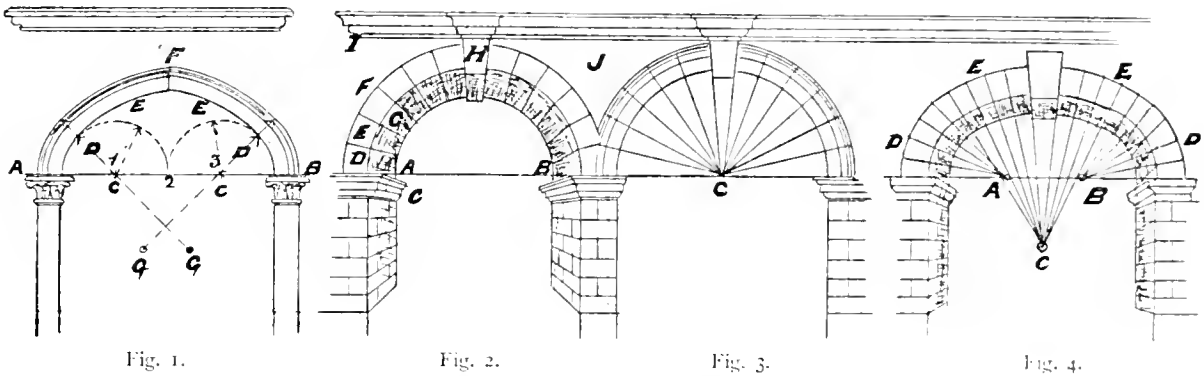

Fig. 1.

Fig. 2.

Fig. 3.

Fig. 4.

No. 205.—SETTING OUT ARCHES.

parts composing it. The width between the piers or abutments is called the "span" of the arch, and is measured in a horizontal line, called the "springing line," as A B. What is called the rise of the arch is the vertical distance measured from the centre of the "springing line" to the under-side or soffit of the arch at the keystone. The highest part of the arch is called the "crown," and the parts behind the extrados, or outside of the arch, which fill up the space between the abutments and the line of "crown" of arch, are called the "haunches." C is the "impost" on the abutment, on which D, the "springer," or first stone of the arch, is placed; E the "voussoirs," or stones which form the arch, and are held in position by H, the "keystone"; F is the "extrados"; G the "intrados," or under side of arch; J the "spandrel," or space between the archivolt moulding; and I is a label moulding, also termed a drip or weather moulding.

MOULDED ARCH.—Fig. 3 is also a semicircular arch, but having a moulding worked on the voussoirs. All the joints radiate from the centre C. The moulding is also run from C.

FLAT ARCH.—Fig. 4 is a flat arch showing intrados and joints. This arch is set out from three centres at the points of an equilateral triangle, as follows:—Divide the springing line into three equal parts. One of these parts forms the side of an equilateral angle as A B C, the angles of which will be the respective centres as A, B, and C to describe the arch D E and E D.

GOTHIC ARCHES. — Illustration No. 206 elucidates the methods of setting out Gothic arches, &c.

TO DESCRIBE A GOTHIC ARCH Fig. 1.—Take AB as the span of the arch; upon B as a centre describe the arc AD. On A as a centre describe the arc BD. Whatever number of lines are required may be produced from the same centres. The joints may also be got from the same points from which the arc is described. For this reason the radius from which the arc is described is always square to the arch.

TO DESCRIBE AN INTRA-CENTRED GOTHIC ARCH Fig. 2.—Take AB as the span of the arch, with compasses on the springing line at A as a centre, describe the arc BC, and on B as a centre describe the arc AC. Divide the arc BC into five equal parts. On the springing line at E describe the arc BJ, taking care to leave sufficient space for the point, the line AJ being the centre of that point. When the centre E is found, on A as a centre describe the line EI, which will give the centres all the way round. This affords a ready method to find the centres, so

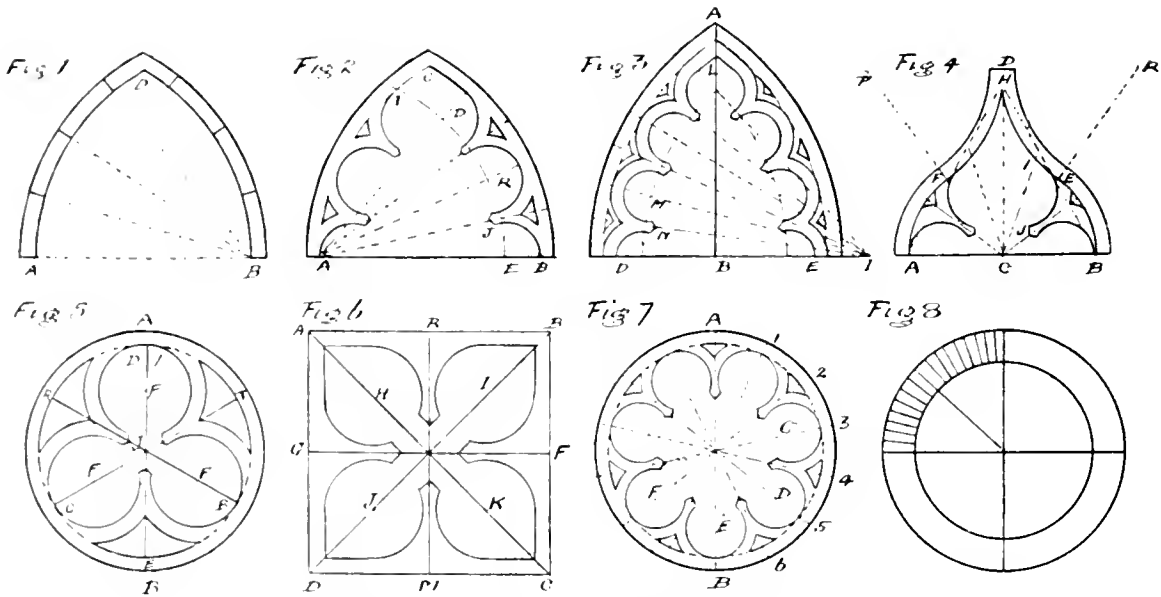

NO. 206.—SETTING OUT GOTHIC ARCHES, PANELS, AND ANGLES.

that wherever the line E intersects the lines AR and AD, these will be the points to strike the cusps from. The cusps on the other side are set out in the same way.

TO DESCRIBE AN EXTRA-CENTRED GOTHIC ARCH Fig. 3.—Take DE as the span of the arch, bisect the springing line at E, take any convenient point on DE as a centre according to the required height of the arch. With ED as a radius describe the line DL, and on the same centre describe all the outer lines which may be requisite. If three cusps be required, as are shown in this figure, divide DL into seven equal parts, then draw the lines LN, LM, &c., and on every alternate line describe the semicircles NM, &c. The joints are also got from the centre. For a Gothic arch that rises just as high as the opening in width, DE would be the centres for describing the arch.

TO CONSTRUCT AN O.G. ARCH Fig. 4.—Take AB as the span of the arch; bisect at C, and draw CD perpendicular to the base line. Join AH and BH, bisect them at F and E; on the centre C describe the arcs AF and BE. By Fig. 3 find the centres P and R, and with the radius ER describe the arc EH, and use the same process for the opposite side. For want of space one-half only of the

radius lines RE and PF are shown. Divide the lines AH and BH into three equal parts each, and from the points draw the lines to C. On the line CB describe the arc BJ, and on CI as a centre describe the arc IJ.

TO DESCRIBE A TREFOIL (Fig. 5).—First draw the vertical line AB, bisect it at J, and on J as a centre describe the inner circle ERT. Divide the semicircle EBI into three equal parts, and in like manner the semicircle AKE. From each division draw the centre lines T and R, and on each line take a centre as at F, F, F, and describe the circles C, B, and D.

TO DRAW A RECTANGULAR QUATREFOIL, Fig. 6.—Draw the line GF, then the centre line RM at right angles to GF, and parallel to them draw the lines AB, BC, CD, DA; then draw the diagonal lines DB and AC, and on these lines as centres describe the circles H, I, J, K, leaving a proportionate width for the cusps. The intersecting short lines are formed parallel with the diagonal lines.

TO CONSTRUCT A GOTHIC WHEEL WINDOW (Fig. 7).—Draw AB, then describe the inner circle according to the size required; then on either side of AB divide the semicircle into as many equal parts as there are points required. Draw the lines 1, 2, 3, 4, 5, and 6, and on every alternate line draw the circles C, D, and E, and so on until the figure is completed.

ANGLES (Fig. 8).—Angles are produced from circles by dividing circles into seconds, minutes, and degrees. Sixty seconds make one minute, 60 minutes make one degree, and 360 degrees make one circle. A circle being divided into 360 equal parts, each part will be one degree, and one quarter of the circle as shown contains 90 degrees, and is called a right angle. The line dividing the quarter is an angle of 45 degrees. Each of the smaller divisions contains five degrees.

RADIUS OF SEGMENTS BY FIGURES.—The following rules for finding by figures the length of radius for a segmental arch or panel (the rise and length being given), will be found practical and quick. If duodecimals are used for computation, the results in most instances will be obtained still more quickly. Suppose the length of a radius rod is required for a segment arch, having a 5-foot span and a 4-inch rise, proceed thus:—

Rule First.—Reduce both lengths to inches, the inch being the lowest factor; then divide the square of half the span by the rise (that is, take half the width and multiply it by itself, and divide by the rise, then add the rise and divide by two, thus—

$$\begin{array}{r}
 \text{Half span } 30 \text{ in.} \\
 \quad \quad \quad 30 \\
 \hline
 \text{Rise } 4 \text{ in. } 900 \\
 \hline
 225 \\
 \quad \quad \quad 4 \text{ in. rise} \\
 \hline
 2 \ 229 \text{ diameter in inches} \\
 \hline
 114\frac{1}{2} \text{ in.} = 9 \text{ ft. } 6\frac{1}{2} \text{ in. radius.}
 \end{array}$$

Rule Second.—Square half the span, and divide by twice the rise, and add half the rise, thus—

$$\begin{array}{r}
 30 \text{ half span} \\
 \quad \quad \quad 30 \\
 \hline
 \text{Twice rise } 8 \ 900 \\
 \hline
 112\frac{1}{2} \\
 \quad \quad \quad \text{Half rise } 2 \\
 \hline
 12 \ 114\frac{1}{2} \\
 \hline
 9 \text{ ft. } 6\frac{1}{2} \text{ in. radius.}
 \end{array}$$

Rule Third.—Add together the square of the rise and the square of half of the span, and divide by twice the rise, thus—

$$\frac{\frac{1}{2} \text{ ft.}^2 + 2 \text{ ft. } 6 \text{ in.}^2}{2 \times \frac{1}{2} \text{ ft.}} = \frac{\frac{1}{2} + 6\frac{1}{4}}{\frac{1}{2}} = \frac{229}{24} = 9\frac{13}{24}, \text{ or } 9 \text{ ft. } 6 \text{ in. and } \frac{1}{4}.$$

Should eighths of an inch occur in the measurements of the span and rise, reduce the lengths to eighths, and proceed by any of the above rules.

ANGLE BRACKETS.—The method of setting out angle brackets, which is shown on the annexed illustration (No. 207), will elucidate the method of setting out angle ribs, and enable plasterers to set out angle or mitre brackets or "laths" for fibrous plaster work, and templates for floating screeds, and running mouldings on surfaces which are circular on plan or elevation, or on both.

The method of setting out a cove bracket at right angles is shown at Fig. 1. Let AC be the

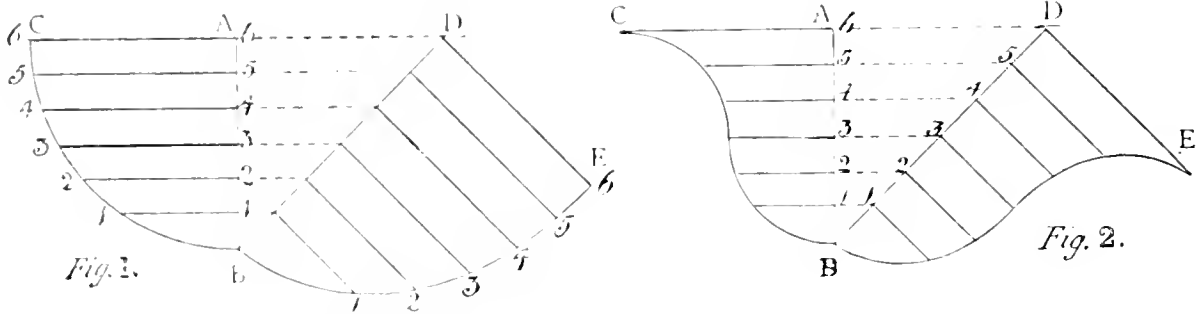

NO. 207.—SETTING OUT ANGLE BRACKETS FOR COVES, &c.

projection, and CB the arc or profile of the cove. Draw the base line AB, and make AD equal to AC, then from D to B draw the diagonal line, which gives the base line of the angle bracket. Divide the profile CB into any number of equal parts, as here into six (the more the better and exact the operation). From these points draw lines parallel to CA, cutting both AB and DB in as many points, thus dividing the base line of the angle bracket DB into the same number of equal parts. From the points in DB draw lines at right angles or perpendicular to DB, and make the lengths of the perpendiculars respectively equal to the lines contained between the base AB and the

profile CB, and through the points of extension, with the aid of a flexible rule, draw the curve EB, thus forming the profile of the desired angle bracket.

The method of setting out the angle bracket of a cyma-recta or "ogee" is shown at Fig. 2. This is effected by a similar operation as used for Fig. 1. These figures are sufficient to show that angle brackets or ribs for any form or profile of front brackets can be set out by the same method.

The method of setting out an angle bracket for a cornice is effected in a similar manner, as already described, and as shown by the annexed illustration (No. 208). Angle

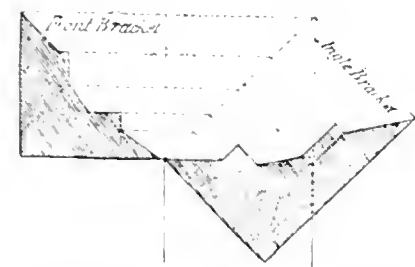

NO. 208.—SETTING OUT ANGLE BRACKETS FOR CORNICES.

brackets or ribs for external mitres, and for obtuse or acute angles, are set out on the above principles.

THE ELEMENTS OF ARCHITECTURE.—The elements of architecture here given are intended to embody a variety of examples in the different styles, and of the methods by which they are drawn, all of which is necessarily more or less directly connected with the plasterer's and modeller's craft. In architecture there are certain elementary forms which, though simple in their nature and few in number, form the principal basis of every composition. Of these there are two distinct kinds, the first consisting of the essential parts which are necessary in construction. The sub-

servient parts contrived for the ornament of the constructional parts, and intended to unite them gracefully together, are usually called mouldings, and constitute the second kind. In architecture there are certain qualities which may be classed as follows:—Magnitude and strength, which affect the eye; order and harmony, which affect the understanding; richness and simplicity, which excite the affections, in which taste is the principal guide. These qualities answer to the two divisions which writers on architecture have usually adopted, namely:—Construction, in which the chief requisites are order and harmony; decoration, whose requisites are richness or simplicity, according to the nature of the composition.

Several modellers and plasterers have risen to be architects, among whom may be mentioned Jean Goujon, a French modeller, who was an architect in the reign of Francis I. He was one of the sufferers in the Massacre of St Bartholomew's Day, 1572. Carlo Maderna, born at Bissone, on the Lago di Coma, 1556, originally a stucco worker, was the architect who changed the plan of St Peter's, Rome, from a Greek into a Latin cross. Forsyth, in his "Remarks on Antiquities, Arts, and Letters in Italy," speaking of St Peter's, says: "Michael Angelo left it an unfinished monument of his proud, towering, gigantic powers, and his awful genius watched over his successors, till at last a wretched plasterer came down from Como to break the sacred unity of the master idea, and him we must execrate for the Latin cross, the aisles, the attic, and the front."

MOULDINGS.—The Romans generally formed their mouldings from parts of the circle, while the Greeks preferred the ellipse, or other sections of the cone. For Gothic mouldings there are no set rules for setting out the curves or profiles, these being generally drawn by hand, and characterised by great freedom of form and position. There are eight regular mouldings, the profiles of which, plain and enriched, are exhibited in the annexed illustration (No. 209). Their names are descriptive of their forms, which are adapted to the uses which they are intended to serve. The ovolo and ogee, being strong at their extremities, are better fitted for supports; the cyma and cavetto, as they are weak in the extreme parts and terminate in a point, are well adapted for coverings to shelter other members. The torus and astragal, shaped like ropes, are intended to bind and strengthen the parts on which they are employed; and the use of the fillet is to separate, contrast, and strengthen the effect of other mouldings, to give a graceful turn to the profile, and to prevent that confusion which would be occasioned by joining several convex members together. The position of the scotia is universally below the level of the eye.

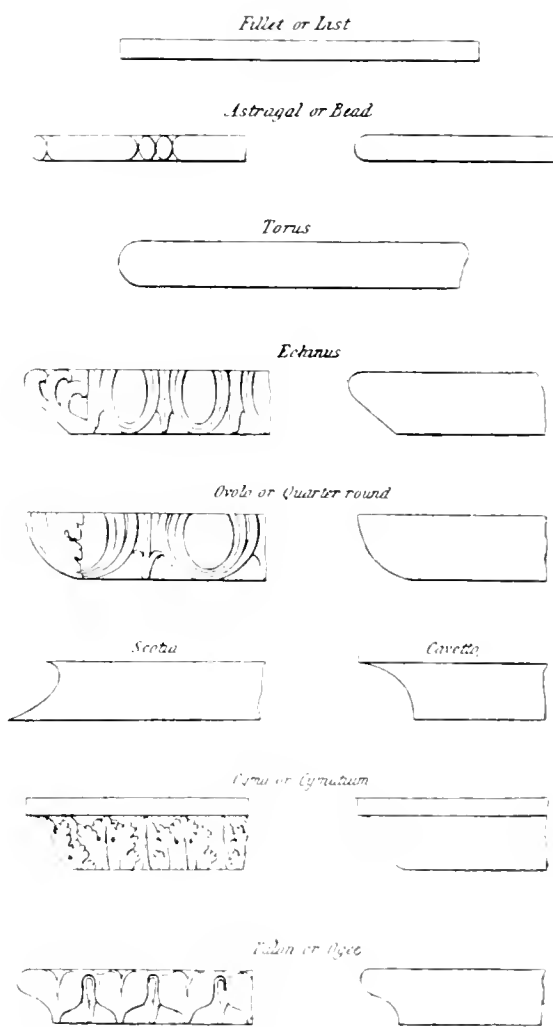

No. 209.—MOULDINGS, PLAIN AND ENRICHED.

An assemblage of essential parts and mouldings is termed a profile; and on the choice, disposition, and proportions of these mouldings depend the beauty, light, and shade of the composition. The most perfect profiles are such as consist of few mouldings, varied both in form and size, fitly applied with regard to their uses, and so distributed that the straight and curved ones succeed each other alternately. In every composition in which mouldings are employed, there ought to be some one predominant member to which all the others should appear subservient, and used either to support, strengthen, or protect it from injuries of the weather. Thus in a cornice, for example, the corona predominates, the cyma and cavetto cover it, the ovolo and ogee support it.

Mouldings are either plain or enriched. When enriched, the ornaments should be cut into the solid, and not applied to the surface, otherwise they would destroy the proportion and contour of the moulding. This applies specially to classical mouldings.

The ancient sculptors, in the execution of their architectural ornaments, aimed at a conventional representation of the objects they chose to imitate; the acorns or eggs with which the ovolo is commonly enriched are in the antiques cut round, and almost entirely detached, as are likewise the beads on the astragal, but the leaves and flowers that enrich the cavetto, cyma, ogee, and torus are kept flat, like the things they represent.

The ornaments of cornices should be made bold, so as to be distinguished at the proper distance, while on the contrary, when the mouldings on the base of the column are to be enriched, they should be more slightly expressed, being near the eye—indeed, it would be impossible to keep them free from dust were they indented by deep cavities.

A fillet is the smallest member in any composition of mouldings. As already mentioned, its purpose is to separate two principal members, and it is used in all situations under such circumstances. The corona is the flat projecting member of a cornice, and forms the principal feature in all Grecian cornices. It should not be ornamented.

Bed moulds are those mouldings which occur between the corona and frieze, and are common to all the orders. The fascia is the principal member of an architrave. The abacus is the upper member of the capital of a column whereon the architrave rests. The original intention in the use of the abacus was to shelter and give breadth to the top of the column, and likewise to serve for the better support of the entablature.

TO DESCRIBE ROMAN MOULDINGS.—Illustration No. 210 elucidates the method of setting out Roman mouldings. Fig. 1 is a quarter round, being a quarter circle; A is the upper extremity, and B the lower; take the vertical line or height from B, and with that radius, from the intersection at *c*, describe the arc A B, which will give the desired contour.

Fig. 2 is a "cavetto," being exactly the reverse of the last figure, and is described in a similar way, with the exception that the centre *c* is formed on the exterior of the member as shown.

Fig. 3 is an ovolo, A being the upper extremity and B the lower; take the vertical line or height as a radius, and from B describe an arc; from A, with the same radius, describe another arc, cutting the former at *c*; then from *c*, with the same radius, describe the arc A B, thus giving the desired profile.

Fig. 4 is the cavetto, and is described in the same way as the last figure, with the exception that the centre *c* is formed on the exterior as shown.

Fig. 5 is a "scotia," which projects equally at each extremity; bisect the vertical line or height from A to B, take half the height as a radius, and from the centre *c* describe the desired contour.

Fig. 6 is a "torus," which is a semicircle inserted on a vertical diameter as from A to B, and

is described the same way as the last figure, with the exception that the centre c is formed on the interior of the member as shown.

Fig. 7 is the "cyma-reversa," composed of two quadrants or quarters of a circle. To describe this, join the projections AB , from these points form a square, and bisect it into four squares as expressed by the dotted lines; from c describe the convex arc, and from f describe the concave arc, which completes the desired contour.

Fig. 8 is the "cyma-recta," being the reverse of the "cyma-reversa," and is described in a similar way.

Fig. 9 is a cyma-reversa that touches a straight line at the points of contrary flexure. To describe this, join the projections AB by the straight line AB ; bisect AB in D ; draw the tangent ED parallel to a line given in position; through D draw cf perpendicular to ED ; bisect AD by a perpendicular, gc ; from the intersection c describe the arc from A to D ; make Dh equal to Dc , and from the point h describe the arc DB , which completes the curve of contrary flexure ABD .

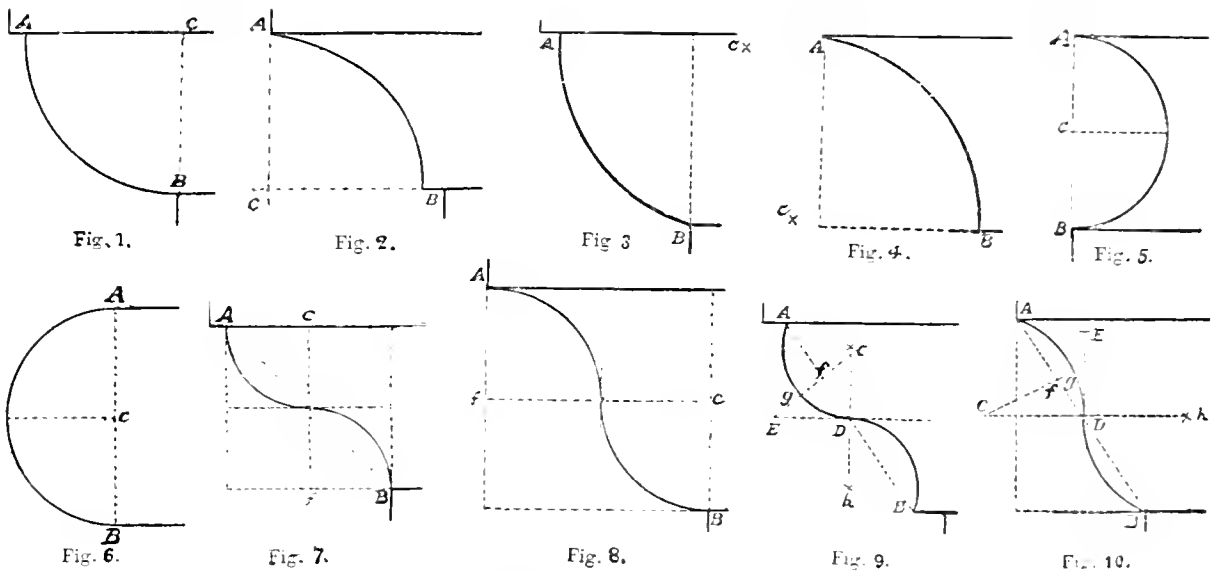

NO. 210.—SETTING OUT ROMAN MOULDINGS.

Fig. 10 is a "cyma-recta" that touches a straight line at the points of contrary flexure, parallel to a given line in position. To describe this, join the points of projection AB ; bisect AB in D , and draw the line DE parallel to the line given in position; bisect AD by the line cg ; from c , with the radius cD , describe the arc AD ; make Dh equal to Dc , and from the point h describe the arc DB , which completes the desired contour.

TO DESCRIBE THE GREEK MOULDINGS.—Illustration No. 211 elucidates the method of describing Grecian mouldings. Fig. 1 is an ovolo. To describe this, two tangents being given, as also their points of contact, let AE and EB be the tangents, A and B the points of contact; complete the parallelogram $BEAF$; then produce BF to c , and make Fc equal to FB ; divide EA and FA each into the same number of equal parts; through the points of division in EA draw lines to B ; and draw lines through the corresponding points in FA to meet the corresponding lines drawn to B ; and the intersections will be the curve of an ellipsis. The upper part AD is a continuation of the same curve.

The same methods are used for Figures 2 and 3, but the following distinctions must be

observed. In Fig. 1 the tangent EB is regulated by taking the point E in the middle of AD . In Fig. 2 the point E is one-third of AD , and in Fig. 3 the point E is one-third of AD from A . Then, according as the tangent is lower or higher, the curve will be quicker or flatter at the same projection. The effect of this will be seen in the difference between Fig. 1, the boldest, and Fig. 3, the flattest.

When EB and AE are nearly equal, the moulding is the boldest of any taking DE at the same height, but when the projection is very great or very small the moulding is extremely flat.

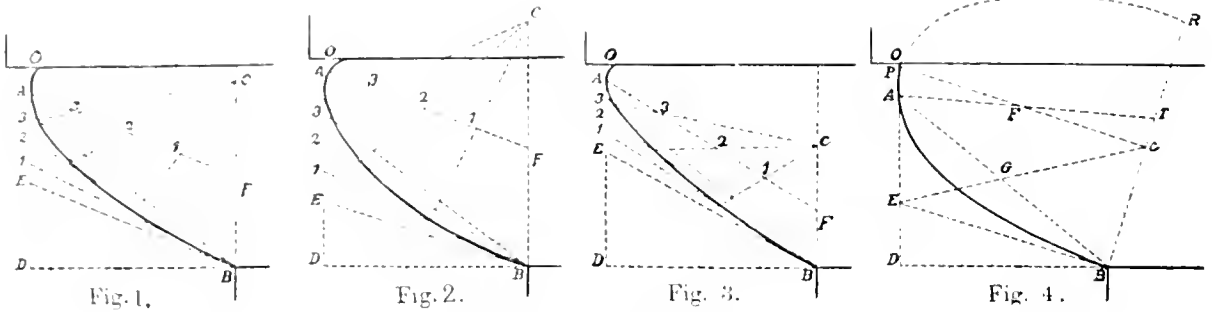

NO. 211. SETTING OUT GRECIAN MOULDINGS.

Fig. 4.—The same data being given to describe the Grecian ovolo, supposing the point of contact B to be the extremity of one of the axes, draw BR at right angles or perpendicular to EB ; also Pc at right angles or perpendicular to BR for the other axis, so that the point P may be above A ; then EB and Pc will be parallel. To find the major axis,—From A , with the distance Bc , describe an arc cutting Pc at F ; draw AF and produce it to meet BR and I ; make cP equal to AI ; then with cP half the major axis, and with cB half the minor axis, describe the curve $BAPcO$, which will give the desired curve. This is the most beautiful moulding of any. The degree of curvature depends on the angle EBD , therefore when this angle is less the curvature will be greater. With regard to the quirk at the point O , it will be more or less as the point A is more or less distant from O . This also applies to the quirks at O in Figs. 1, 2, and 3.

TO DESCRIBE A BEAD AND SCOTIA.—The method of drawing a bead with fillets, and

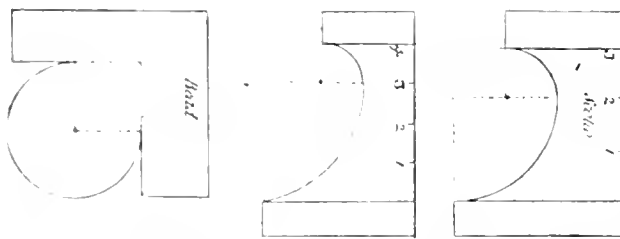

NO. 212. SETTING OUT A BEAD WITH FILLETS AND SCOTIAS.

two forms of scotia members, is elucidated in illustration No. 212. The centre of the bead is obtained from the angle of a square equal in size to half the diameter of the bead, as indicated by the thick "centre" dot at an angle of the dotted lines. The scotia is generally composed of elliptical forms, or quadrants of the circle, differing more or less from each other, as shown in

this illustration, by which means its projection may either be increased or diminished.

To describe the scotia on the right of the illustration, divide the height in three parts as figured. Through the point at 2 draw a horizontal line parallel to the fillet line at 3, and equal to one part, then draw a line perpendicular with the section line of the top fillet until it intersects with the horizontal line, and on the point of intersection describe the quadrant, which forms the upper part of the scotia. Next set off one part on the other side as indicated by the circular dotted line, then from the outward point of intersection describe the arc which completes the curve of the

scotia. If a greater projection is required as shown by the scotia in the centre of the illustration, divide the height into four parts, as figured, then proceed as before to form the quadrant, but to increase the projection set off two parts on the outside of the horizontal line, and from the outer point describe the arc as before. The dotted lines and thick points indicate the line, centres, and radius for setting out the various parts of the members.

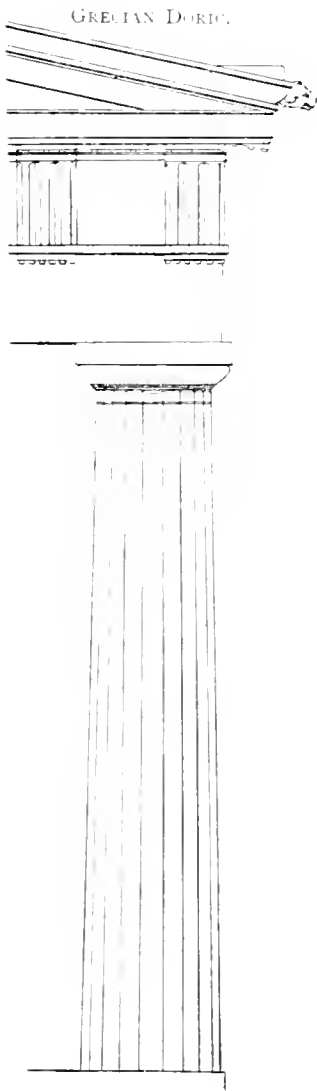

No. 213.—COLUMNS AND ENTABLATURES.

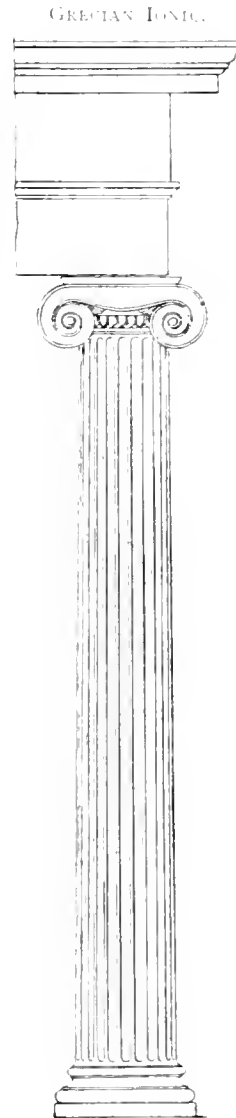
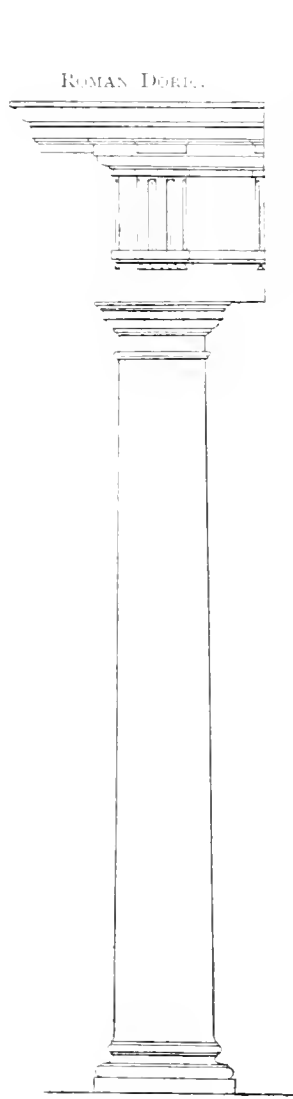

No. 214.—COLUMNS AND ENTABLATURES.

THE ORDERS OF ARCHITECTURE.—The three ancient orders are the Doric, Ionic, and Corinthian. These are called the Grecian orders. They exhibit three distinct features of composition, and are supposed to have been suggested by the diversity of character in the human frame. The Romans had five, namely, the Tuscan, Doric, Ionic, Corinthian, and the Composite. At what time they were invented or by whom perfected is at least doubtful.

Vitruvius, Scamozzi, Vignola, and other architects vary more or less in the proportions of the

various orders. The proportions here given are those most in use, and have the claim of preference.

THE GRECIAN ORDERS: THE DORIC.—This being the most ancient of all the orders, retains more of the structure of the primitive hut in its form than any of the others, having triglyphs in the frieze to represent the joists, and modules in the cornice to represent rafters, with inclined soffits to express their direction in the originals which they imitated. In Greece the columns of this order were placed on the floor without either pedestal or base. The best examples are only from 5 to 6 diameters high, which gives peculiar grandeur to the temples in which the Doric order is employed. The flutes of the column are elliptical in form and twenty in number. The capital is about half a diameter high, and is composed of a plain abacus, a flat ovolo of great projection, and a few small fillets, called annulets which divide it from the shaft. The entablature is divided so that the architrave and frieze are each more than a third of its height, and the remainder is given to the cornice. Illustration No. 213 shows examples of the Grecian and Roman columns and entablatures in the Doric order. This fine example of Grecian Doric is from the Parthenon at Athens, taken from the angle column of the portico to show the pediment. For the sake of ready comparison, Grecian and Roman examples of the same order are given in one illustration.



NO. 215.—ACANTHUS MOLLIS, THE SUPPOSED ORIGIN OF THE CORINTHIAN CAPITAL.

THE IONIC.—This order, being the second of the Grecian orders, holds a middle position, standing in equipoise between the grave solidity of the Doric and the elegant delicacy of the Corinthian. This order is said to have been invented by Ion, of Iona, a province of Asia, where he erected a temple in this order to Diana. The Grecian Ionic column is not so high as the Roman Ionic but the entablature is bolder and of fewer parts. The Ionic shaft usually has twenty-four flutes. The distinguishing feature of the order is the capital, in which there is a considerable difference between the Grecian and Roman examples. In the former the volutes appear only in front and rear, and are placed flat on the column, leaving the ends in the form of part of a baluster. This part is sometimes enriched. The Romans gave their Ionic capitals four diagonal volutes, and hollowed out the sides of the abacus. Illustration No. 214 shows beautiful examples of Ionic columns and entablatures.

THE CORINTHIAN.—This, the third and last of the Grecian orders, admits of the highest degree of enrichment, and possesses at once an air of dignity and beauty. The invention of the graceful capital of this order has the following romantic history. A Corinthian maiden having died, her lover placed on her tomb a basket containing trinkets in which she delighted when alive. He put a tile on the basket to better shelter the contents. The basket was placed accidentally on the root of an acanthus, which growing, shot its stems and foliage up and around the basket. Some of the

leaves reaching the angles of the tile, were forced downwards, and by degrees curled into the form of the volute. Callimachus, who for his great ingenuity and taste in sculpture was called by the Athenians "Katatexnos," passing the tomb, saw the basket, tile, and the delicacy of the acanthus leaves which grew around, and being pleased with the form and novelty of the combination, used it as a model for the capital. The story is a pretty one, but must, we fear, be added to the long list of popular but erroneous tradition. Illustration No. 215 depicts a view of the *Acanthus mollis* the supposed origin of the Corinthian capital, and is a good example for the young plasterer to first draw and then model. The drawing and model should be made twice or even thrice the size of the example. It will be easier to model it on a ground than on the round.

This beautiful order can but be viewed with equal pleasure and admiration. It remains to this day a perfect masterpiece of art. One of the most beautiful examples of Grecian capitals is shown on illustration No. 216. This capital is one diameter and twenty-four parts in height. Its cone is a perfect cylinder. This is banded by a row of water leaves, one-sixth of the whole height, and another of acanthus, with flowered buttons attaching them to the cylinder.

THE ROMAN ORDERS: THE TUSCAN.—This order is the simplest and most solid of all the orders. It is composed of five parts, devoid of ornament, and of so massive a construction that it seems capable of supporting the heaviest burdens. This order is said to have been invented by a native of Tuscany. It is the first order according to the Roman system, and is nearly the same as their Doric, divested of its triglyphs and mutules. It is the most easily executed, and when employed with judgment, has not only grace, but by contrast gives a beauty to the other orders. The methods of drawing an order and setting out the heights and projections of the mouldings are all taken from the standard of measurement of each column, the standard being the diameter of the shaft immediately above the base. Divide this into a scale of sixty equal parts. This is done by first dividing the diameter into two equal parts, called "modules," then each of these into thirty equal parts, called "minutes." If necessary, each part may be divided into sixty parts, called "seconds." The standard is therefore sixty seconds = one part or minute; thirty minutes = one module; two modules = one diameter or sixty parts. The parts, base, shaft, and capital are termed the column. The mouldings above the capital are termed the entablature. The parts below the base of the column are called the pedestal. Illustration No. 217 shows the profile of the column and entablature of this order. The heights of the column and entablature and their subdivisions are named and figured on the inside of the profile, and the projections are figured on the outside of the profile: the latter is taken from the line of column. The column diminishes one-tenth to one-quarter of its diameter. All dimensions correspond with the scale of minutes.

ROMAN DORIC.—This order takes its name from the Dorians, a Grecian people in Asia. It is next in strength to the Tuscan, and is distinguished by the channels and projecting intervals in the frieze, called "triglyphs." These are placed over the centres of the columns. The metopes and mutules are exact squares, hence the intercolumnations are regulated by the triglyphs, which makes

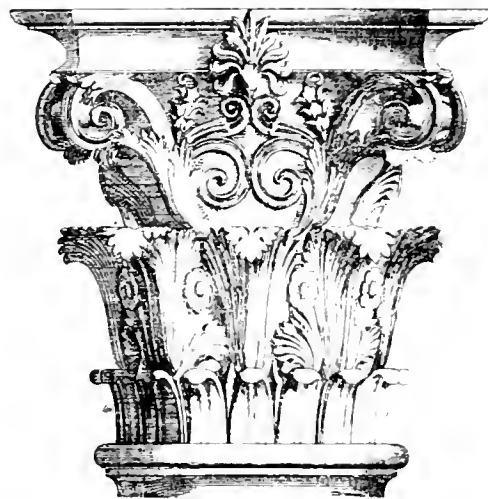

NO. 216.—GRECIAN CAPITAL FROM THE CHORAGI-MONUMENT OF LYSICRAES.

it difficult to execute. The shaft of column is seven diameters high. The base and capital are one module each, making the column eight diameters high. The entablature is two diameters; the two "triglyphs" are each six modules wide. The metopes (or spaces between the triglyphs) are square, and are often filled in with some ornament, generally representing the skeleton head of an ox. The column is sometimes fluted, like the Grecian Doric. The Doric column and entablature is shown on illustration No. 213.

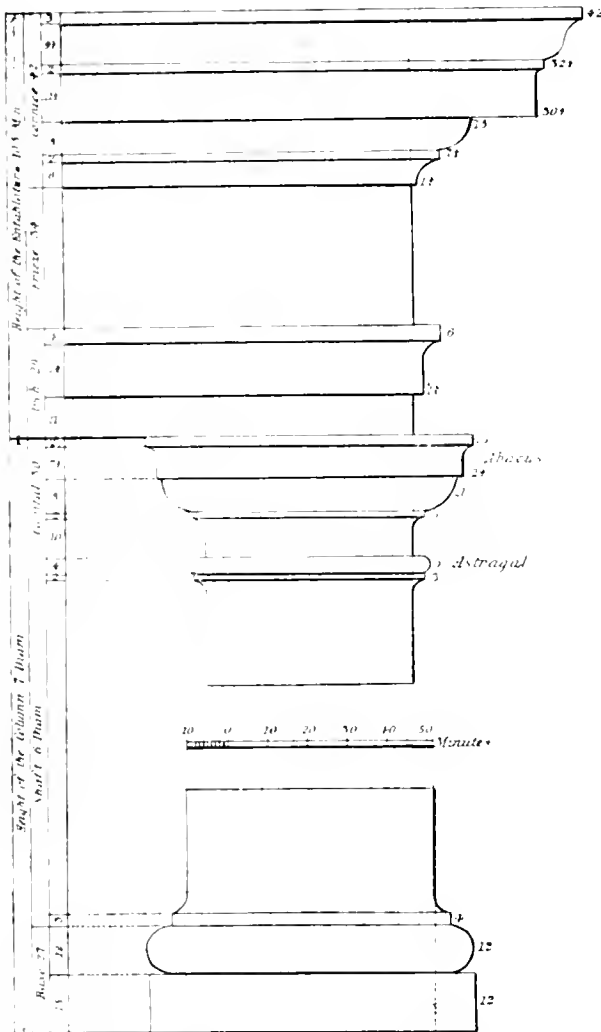

NO. 217.—THE TUSCAN COLUMN AND ENTABLATURE.

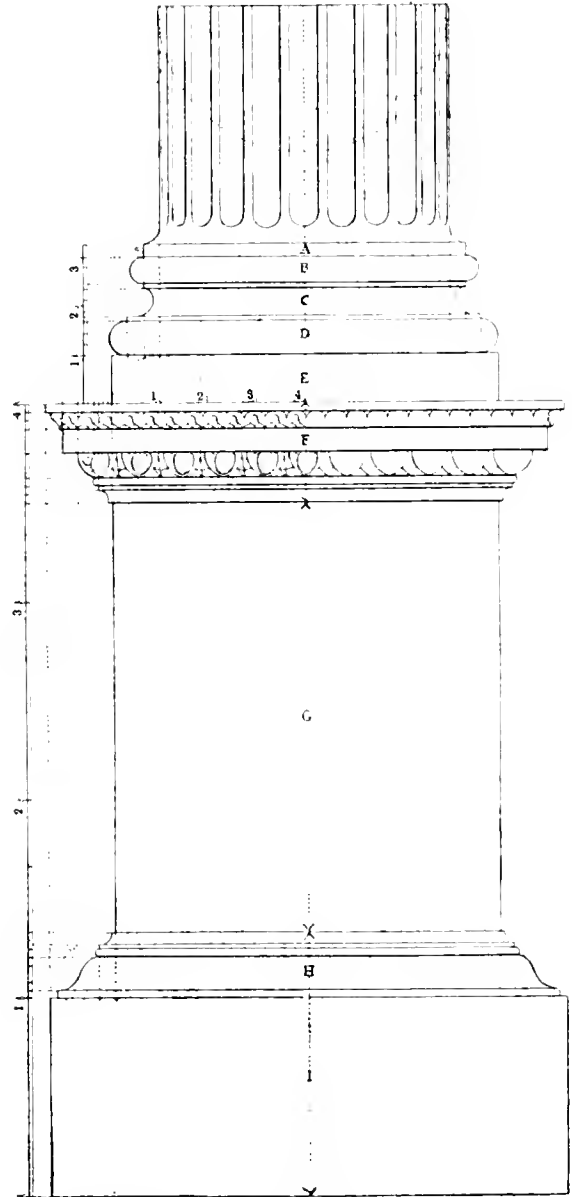

NO. 218.—SLITTING OUT AN IONIC PEDAESTAL FOR A COLUMN.

ROMAN IONIC.—This order is somewhat similar to the Greek Ionic. The column is nine diameters high, and diminishes two-fifths of its diameter. The entablature is from one-fourth to one-fifth of the height of the column.

The drawing to scale and making a model about 2 feet or 3 feet in height of the column and

capital of this order is good instructive practice for the young plasterer. The model may be kept as a sample and for future reference when making a full-sized column. The construction of small models to scale of the five orders would afford excellent practice for young plasterers in model-making and modelling. The column and entablature of this order is shown with the Grecian Ionic, on page 527. Plans, sections, and elevations of Ionic capitals are illustrated in Chapter X.

TO SET OUT AN IONIC PEDESTAL. — Illustration No. 218 shows the elevation of an Ionic pedestal with part of the column and its base. A is the list or fillet, B the upper torus, C the scotia, D the lower torus, and E the plinth of the base of the column; F is the cyma of the cornice of the pedestal, G is the dado or die, H the base, and I the plinth of the base. The entablature of an order being a part proportionable to its column, and the pedestal an addition to both, it is considered as a part of the column and entablature taken together; therefore the height of the column and entablature being divided into four equal parts, one of them is taken as the height of the pedestal. This rule and the general divisions of the Ionic pedestal are observed in each of the five orders. The height of the column being divided into nine parts, one of them is the diameter of it, as already mentioned. The height of the base of the column is equal to half the diameter of the column. The projection of the base is one-third of the semi-diameter of the column, and that determines the breadth of the die of the pedestal. Divide the height of the pedestal into four parts. One is the height of the plinth, half the height of one of them is the height of the cap, and one-third of one of them is the height of the base of the pedestal. The projection of the base is equal to its height, and the cap has the same projection as the base. The upright scale shows the heights and subdivisions of the members of the various parts of the pedestal and base of the column, and the horizontal scale shows the divisions of the members and their projections. The method of drawing the various members is shown and described in the paragraph relating to mouldings.

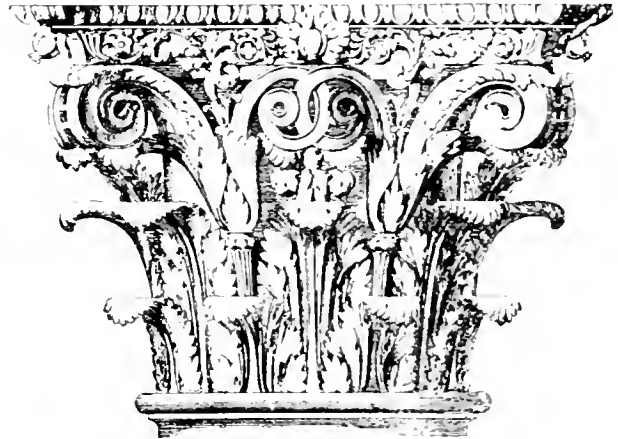

No. 219.—CORINTHIAN CAPITAL FROM THE TEMPLE OF JUPITER STATOR, ROME.

THE CORINTHIAN.—This elegant order is distinguished by the superior height of the capital, and being ornamented with leaves, which support the volutes, flowing to the angles and centre of the abacus. The capital is in the form of a vase, the lower part being covered with two rows of leaves, one above the other, eight in each row. Over these there is a third row of narrower leaves, which cover the springing, and follow the curve of the eight volutes. The whole is crowned with either a plain or an enriched abacus, concave on the four sides. The entablature is highly enriched. Its architrave has usually three fasciæ of unequal height, and the frieze is frequently decorated with foliage. The cornice has modillions and dentils. The column, including base, is generally $9\frac{1}{2}$ diameters high, and diminishes one-eighth part of its diameter. The entablature is generally one-fifth of the height of the column. The height of the capital is seventy minutes, of which the abacus should be a seventh part, the remaining portion being divided into three equal parts; the two lower give the height of the first and second rows of leaves, and the upper part the space of the volutes.

Illustration No. 219 shows the Corinthian capital of the three columns in the Campo Vaccino,

the supposed remains of the temple of Jupiter Stator. This is generally allowed to be the most perfect model of the Corinthian order amongst the antiques of Rome. Palladio, in his fourth book, states that he never had seen any work better executed, or more delicately finished; that the parts are beautifully formed, well proportioned, and skilfully combined.

THE COMPOSITE.—This order is so called because it is composed of the Ionic and Corinthian.

The capital is a vase covered with two rows of acanthus leaves, and is distinguished from that of the Corinthian by having the large volutes and enriched ovolo of the Ionic capital; but in other respects it is similar, both in proportions and mouldings. The column, including the vase and capital, is ten diameters high, and diminishes one-eighth of its diameter. This order was first used by the Romans in their triumphal arches. Illustration No. 220 shows examples of the columns and entablatures of the Corinthian and Composite orders.

THE HEIGHT OF COLUMNS.—The height of a column in each order is measured by its diameter immediately above the base. The ancient Grecian Doric is from five to six diameters in height. The Tuscan column, seven diameters. The Roman Doric, eight diameters. The Ionic, nine diameters. The Corinthian, ten diameters. The Composite, ten diameters. In the foregoing measurements are included the capitals and bases, which are esteemed parts of the column with the shaft of which they are conjoined.

THE DIMINUTION OF COLUMNS.—The shafts of columns are diminished in diameter as they rise. The ancient columns were tapered from the base to the top in a straight line, in imitation of trees, so that their shaft was a frustum of the cone. In some examples there is a swelling in the middle. The diminution at top is seldom less than one-eighth, nor more than one-sixth of the inferior diameter of the column. The method

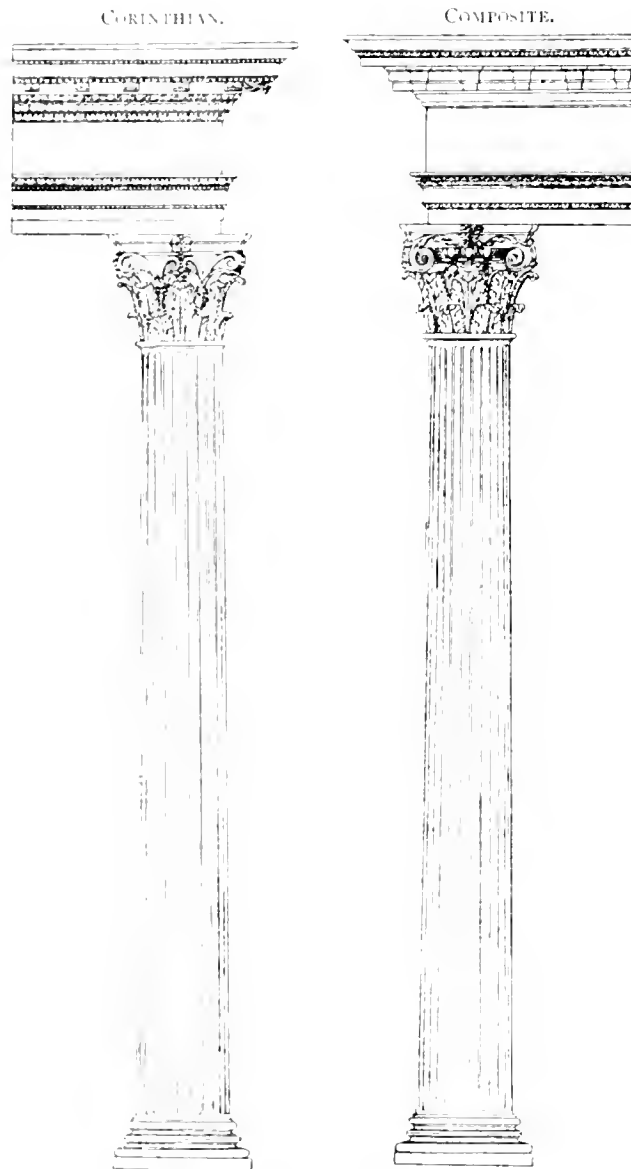

NO. 220. —COLUMNS AND ENTABLATURES IN THE CORINTHIAN AND COMPOSITE ORDERS.

of setting out and constructing diminished columns is given in Chapter VI.

PROPORTION OF ENTABLATURES.—The height of the entablature in all the orders has in general been made one-quarter of the height of the column. The total height thus obtained is in all the orders, except the Doric, divided into ten parts, three of which are given to the architrave, three to the frieze, and four to the cornice. But in the Doric order the whole height should be

divided into eight parts, and two given to the architrave, three to the frieze, and three to the cornice. The above proportions are sometimes varied to suit different buildings.

PILASTERS.—These are said to be a Roman invention. They bear an analogy to columns in

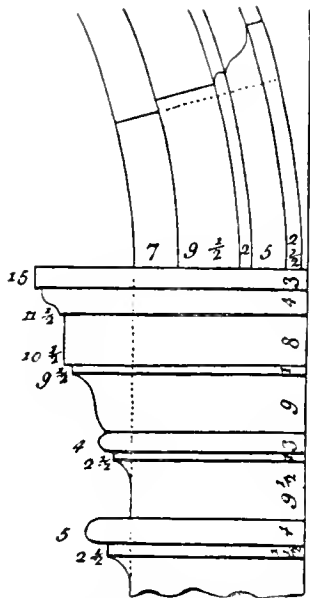

No. 221.—DORIC IMPOST AND ARCHIVOLT MOULDINGS.

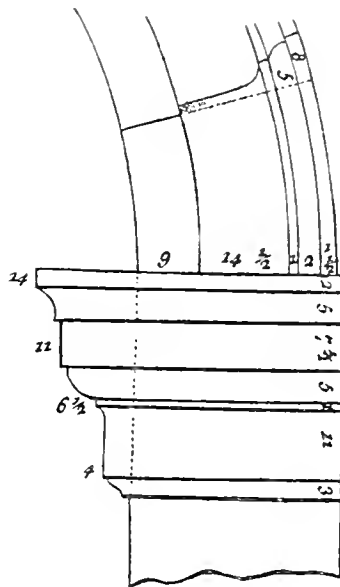

No. 222.—IONIC IMPOST AND ARCHIVOLT MOULDINGS.

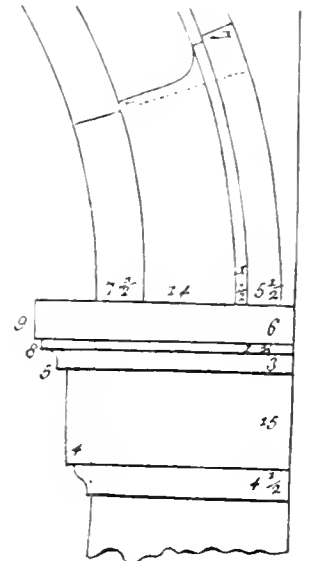

No. 223.—TUSCAN IMPOST AND ARCHIVOLT MOULDINGS.

their parts, and must have their bases, capitals, and entablatures the same height as those of columns. When pilasters are used alone, as principals in the composition, they should be made to project one-fourth of their diameter. This gives great regularity to the returned parts of the capitals, more particularly if the pilasters should be Corinthian.

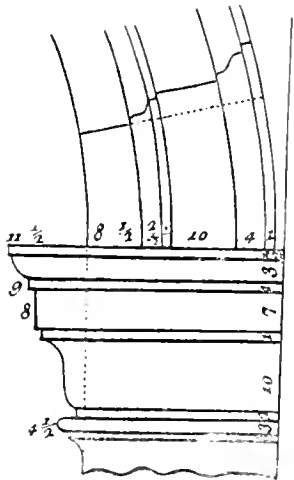

No. 224.—CORINTHIAN IMPOST AND ARCHIVOLT MOULDINGS.

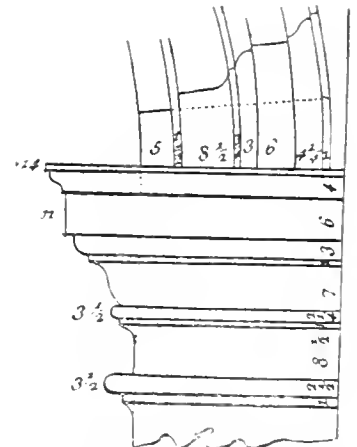

No. 225.—COMPOSITE IMPOST AND ARCHIVOLT MOULDINGS.

IMPOST AND ARCHITRAVE MOULDINGS.—The impost is the horizontal moulding or capitals on the top of a pilaster, pillar, pier, or abutment from which an arch springs. In classical architecture the form varies in the several orders. Sometimes the entablature of the order serves for the impost of an arch. The architrave or impost is the moulding on the face of an arch, concentric with the intrados, and supported by imposts. Impost and archivolt mouldings to arches for classical work are set out to the scale of the order employed. The annexed illustrations (Nos. 221, 222, 223, 224, and 225) show the elevations and sections, with figured projections and heights of the members, of the imposts and archivolts of the five orders. These mouldings are frequently enriched.

BALUSTERS.—A baluster is a small pillar or pilaster serving to support a rail or cornice generally ornamented with mouldings. A series of balusters is termed a balustrade, and is used for surrounding balconies, terraces, &c. They are generally drawn to a scale of minutes. The annexed illustration No. 226 shows the elevations of the balusters appertaining to the five orders. Fig. 1, Composite. Fig. 2, Corinthian, with the base moulding B, and cornice or rail moulding R. Fig. 3, Tuscan, square on plan. Fig. 4, Doric or Ionic. The top and bottom members are square on plan, and the part between called the body is circular. This form of baluster is sometimes called a double-bellied baluster. Fig. 5, Doric, another variety, is square on plan. Fig. 6, Corinthian, ramped for steps, &c., with base and rail mouldings showing a half baluster butting against a pier or die.

TO SET OUT BALUSTRADES.—The method of setting out the proportions of various kinds of balusters and pedestals for balustrades is elucidated by the subjoined illustration (No. 227). Fig. 1 shows the half elevation of a single-bellied baluster. The top and bottom plinths, P, P, are square on

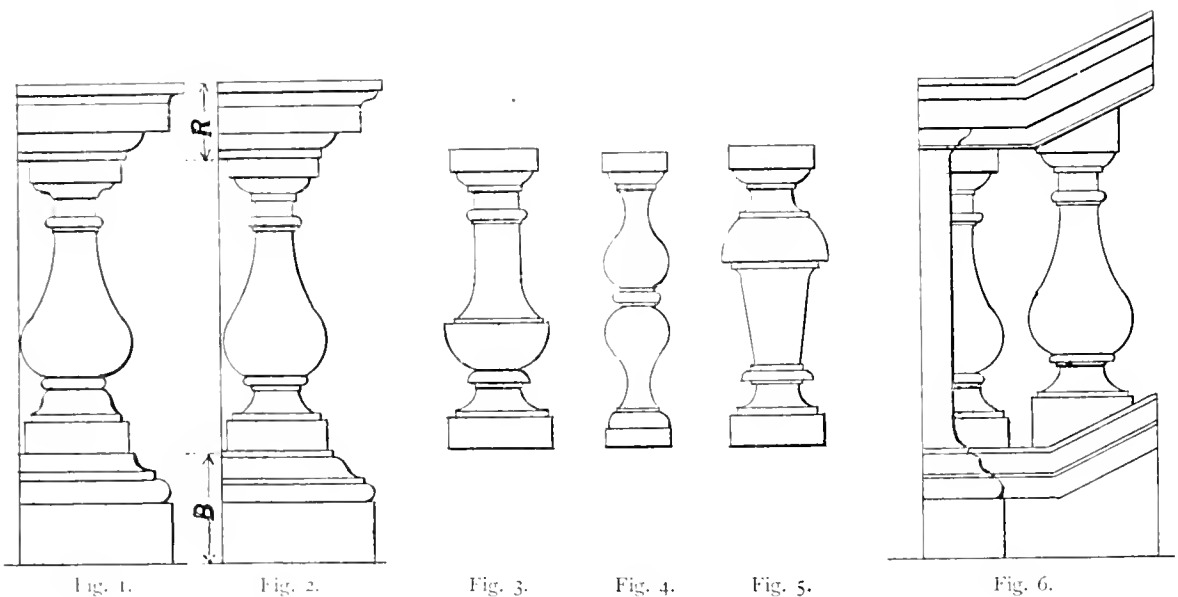

NO. 226.—BALUSTERS OF THE FIVE ORDERS, AND RAMPED BALUSTRADE.

plan, and the moulded part between them (termed the body) is circular on plan. The height is divided into eight parts, two of which go to the width, as shown by the upright scale. This scale is subdivided to give the proportions of the various members, and to give the centres for the reversed curves of the bellied part, the centres and radius for the latter part being indicated by the dotted lines. Fig. 2 shows the elevation of half of a pedestal with a half baluster engaged on its flank or inward side, also a complete baluster. This is a reduced size of Fig. 1. The pedestal consists of three parts—the base, B; the die or body, D; and the cap, C.

The height of bases and caps varies according to the style and position, but the proportions are regulated by the height of the balustrade. The general proportion for balustrades is to divide the whole given height into thirteen equal parts, and to make the height of the baluster eight of those parts, the height of the base three, and that of the cornice or rail two. If it is required to make the baluster less, the height may be divided into fourteen parts, giving eight to the baluster, four to the base, and two to the cornice. One of the parts may be called a module, and being divided into nine

minutes, serves to determine the dimensions of the various members. In this example the height of the cornice C is two parts, and the height of the base B four and three-fourths, as shown by the scale on the die of the pedestal. The distance between the balusters is one-half of their width, as shown by the figures at the top of the base. The dotted lines show the centres of the bellied parts. The foregoing remarks as to proportions, centres, &c., also apply to the following examples. Fig. 3 shows a baluster with the height divided into nine parts. Fig. 4 shows an enriched baluster with the height divided into twelve parts. Fig. 5 shows a double-bellied baluster. Fig. 6 shows the elevation of a half of a pedestal with an engaged half baluster on its flank, and a whole baluster. This is a reduced size of Fig. 5. The sunk panel in the die, D, of the pedestal is proportioned according to the parts figured on the side of the die.

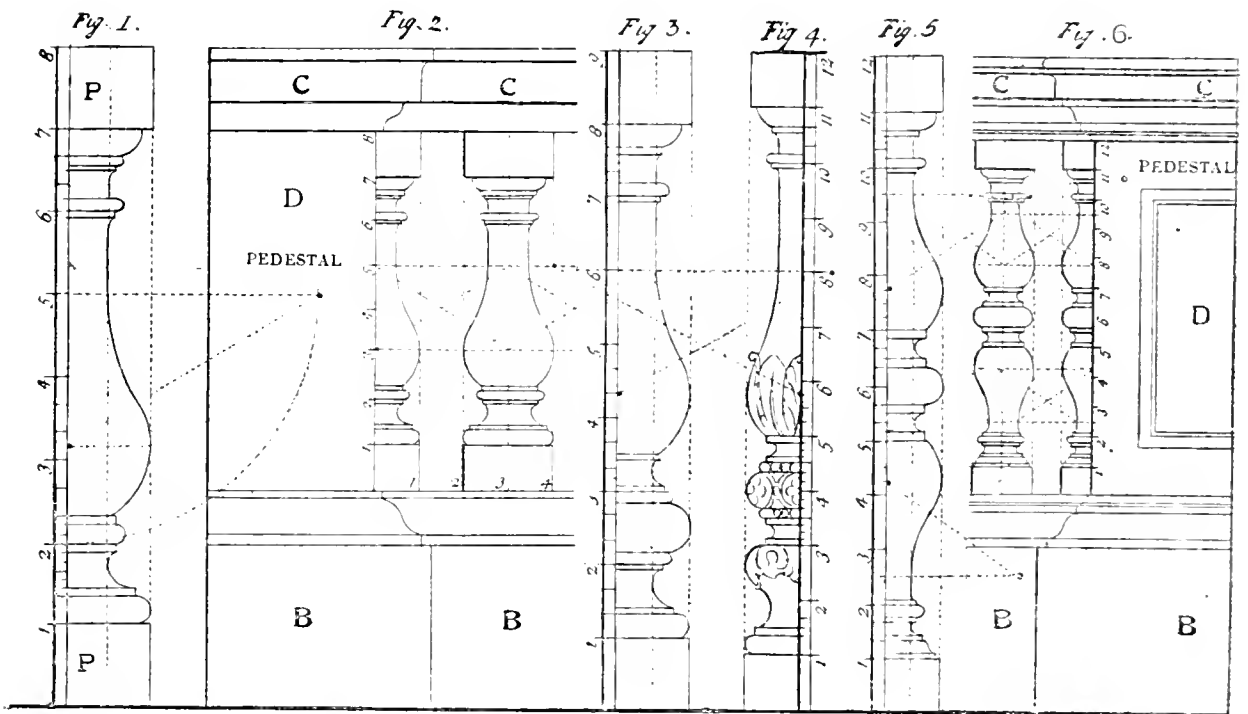

NO. 227.—SETTING OUT BALUSTERS AND PEDESTALS FOR BALUSTRADES.

The distance between two balusters in a balustrade should not exceed half the diameter of the baluster, measured in its thickest part, nor be less than one-third of it. The pedestals that support the rail should be at a reasonable distance from each other, for if they be too frequent the balustrade will have a heavy appearance, and if they be far asunder it will be weak. The most eligible distance between them is when space is left in each interval for eight or nine whole balusters, besides the two half ones engaged in the flanks of the pedestals. But as the disposition of the pedestals depends on the situation of the piers, pilasters, or columns in the front—it being always deemed necessary to place a pedestal directly over the middle of each of these—it frequently happens that the intervals are sufficient to contain sixteen or eighteen balusters. In this case each range may be divided into two, or which is better, three intervals, by placing a die or two dies in the range, each flanked with two half balusters. The breadth of these dies may be from two-thirds to three-quarters of the width

of those of the principal pedestals. The rail and base mouldings are generally carried over and under them in a straight line, without breaks.

COPYING MOULDINGS.—Architects and students in building construction have devoted much time to copying the mouldings of ancient and modern buildings. Of the several ways of doing this the most simple of all is effected by inserting a piece of stiff paper in a loose joint, or by applying the paper where a stone has been removed, and has left the edges sufficiently clear for the right lines to be traced by a pencil. This method is seldom available except in ruined buildings, or where additions or alterations are to be made. Another way is by the use of a thin flexible lead tape, which is pressed upon the moulding to be copied, and thence carefully removed, and laid upon a sheet of paper. This retains the shape it has taken, and it may be traced off with a pencil. This method is unreliable where perfect accuracy is imperative. The most complex mouldings can be copied with perfect accuracy by the aid of an ingenious instrument called the "Cymagraph," invented by Professor Willis. Another instrument, invented by Mr Henry Bashforth, possesses the remarkable advantage of copying mouldings, and also of reducing the copy to any desired scale. Mouldings may be copied and also reduced by geometric methods, as described and illustrated on page 289. Another way is to copy by the eye alone. A practice of copying mouldings by the eye is of great importance in acquiring a sound acquaintance with this very interesting subject. After a little practice the eye becomes perfectly familiar with every kind and variety of moulding by contemplating and comparing new examples with others previously made. In this way mouldings which are out of reach may be sketched very tolerably, especially if the planes in which they lie be carefully formed. The planes in which the mouldings lie, such as the ceiling and wall lines, and the relative proportions of the parts, must be carefully observed. By adding the measurements of the projection and depth of the moulding and the main parts, any inaccuracy of proportion may readily be rectified. Full-sized mouldings are easily reduced to any desired scale by the use of the well-known instrument called the pentagraph. Mouldings within reach may be quickly copied by means of squeezing. This is effected by first dusting the part to be copied with French chalk, and then pressing moist clay or squeezing-wax on until thick enough to be moved. Plaster should then be poured into the matrix thus formed, which yields a copy of the original moulding. But the most ready and accurate method is that of taking a plaster mould or template of the part to be copied, the form of which is accurately obtained, though the convex and concave surfaces are of course reversed. By pouring plaster on the mould an exact copy of the original moulding is obtained. The profile of the moulding may also be easily obtained by laying the mould on a sheet of paper, and drawing the contour with a pencil. The mould for this process is made in precisely the same way as used by plasterers to obtain the profile of an old moulding when about to make a running mould for repairs or additions to cornices. This is effected by brushing the part to be copied with oil or clay water, then laying gauged plaster on the surface, so as to form a vertical body (from the ceiling to the wall lines) about 2 inches wide, and in sufficient depth for the requisite strength. When the plaster is set the mould is taken off. If the moulding is undercut, the mould must be made at a cut end of the moulding, so as to allow the mould to be pushed along and be extracted when it is clear of the undercut parts. For large and intricate mouldings, or those deeply undercut, the mould must be made in pieces similar to a plaster piece mould.

CHAPTER XXI.

TOOLS AND APPLIANCES.

PLASTERERS' TOOLS, APPLIANCES, AND PLANT — LABOURERS' TOOLS — SCAFFOLDING — THE WORSHIPFUL COMPANY OF PLASTERERS—THE PLASTERERS' CRAFT.

PLASTERERS' TOOLS.—Tools are necessary aids to all classes of workmen, and precisely as the tree is known by its fruit, so is the workman known by his tools. The workman who shows little interest in his tools takes little interest in his work. A good workman keeps a good set of tools. Of course there are exceptions, as when a man through adversity has "parted with" some of his "kit." There is a story of a man on the road, whose kit consisted of an old hawk, a hand-float, and the handle of a stock-brush, all carefully tied up in an old apron. Being successful in obtaining a job, he went on the scaffold where there were several men at work, and being twitted about his slender and damaged stock of tools, he stuck his brush, or rather the handle of it, into a pail of water among some other brushes, saying that his brush (the handle) looked as well as the best brush in the pail. It is surprising how little interest is taken by some men in a good and full kit of tools. They will either borrow, or plod and blunder on for years with a few old implements, until they are outpaced either in time or quality, or both, by more thoughtful and careful men, who have not only good and clean tools, but also a proper tool for each section of the work. To the young and persevering plasterer I would suggest a quotation from Shakespeare—"Take you to your tools."

Among the plasterers' relics found by Dr Flinders Petrie at Kahun, in Egypt, were two hand-floats. Having seen them at the University College, London, where they are now located I took their measurements, which are as follows:—One is $3\frac{3}{4}$ inches long and $1\frac{1}{2}$ inches wide, rounded at both ends, and slightly convex on the sole. The handle extends all the length of the sole as in our modern panel-floats, and the whole float is cut in the solid. The other is longer, and has evidently been used for the rough coat. The sole projects beyond the handle, more at one end than at the other, somewhat like our modern skimming hand-floats. This is also cut out of a solid block. Both of these were smeared with mud plaster, just as their owner had left them. These are the oldest known plaster tools in the world, and were used for plastering B.C. 2500.

Plate LII. illustrates plasterers' tools, plant, and appliances. A is the stand, B the gauge board, and C the platform, nailed on the bottom rail of the stand. No. 1 is a laying trowel with a double "shank." 2. Laying trowel with a single "shank." 3. Panel trowel. 4. Margin trowel. 5. Gauging trowel. 6. Small gauging trowel. 7. Large gauging trowel. 8. A hawk. 9. Ordinary hand-float. 10. Cross-grained hand-float. 11. Skimming-float. 12. Joint rule with stock. 13. Small joint rule with stock. 14. Small joint rule without stock. 15. Moulding knife. 16. Plaster chisel. 17. Level. 18. Chalk line and reel. 19. Fine drag. 20. Coarse drag. 21. Scratch drag. 22. Brad-awl. 23. Tool-brush. 24. Large tool-brush. 25. Duster. 26. Flat wide stock-brush. 27. Four-tufted stock-brush. 28. Hand-float for cement work. 29. Panel-float. 30. Fining-float with round end. 31. Fining-float with splayed end. 32. Water pot. 33. Plaster plane. 34. Lath hammer. 35. Fine hand sieve. 36. Gauge pot. 37. Mitre box. 38. Square. 39. Compasses.

40. Plumb rule and bob. 41 and 41A. Scratches. 42. Combined square, triangle, and level. 43. Broom. 44. Pail. 45. Tool bag. 46. Water measure. 47. Tool box. 48. Darby. 49. Plaster box stand. 50. Plaster box. 51. Angle-float. 52. Concrete rule. 53. Gauge rule. 54. Nippers. 55. Traversing rule. 56. Feather edge rule. 57. Saw.

BANKER.—A banker is used for gauging large quantities of material, the gauging being done with shovels. They were in general use when hawk-boys did all the gauging for plasterers. Bankers are made about 5 feet long and 4 feet wide, with side boards, 6 inches high, on two sides and on end.

BRUSHES.—Good brushes are formed with hog bristles nailed or bound on wood handles with string, copper wire, or metal bands. Cheap brushes are formed with grass fibre, &c. The principal one is the stock-brush, which varies slightly in size and form. In some districts a brush having three or four tufts tied with string or wire is used; in other districts a flat wide brush bound with leather and nailed is preferred. Tool or sash brushes are used for mitring, stopping, and general shopwork. Fibrous brushes are generally home made. The hair is about 4 inches long, and tied on a handle about 6 inches long, $1\frac{1}{2}$ inches wide, and $\frac{1}{2}$ inch thick. After the string is tied, it is saturated with hot glue. A hot iron is afterwards passed over the glue to bind the hair together. It is customary for employers to supply stock-brushes (for whitewashing only) and all shop brushes, the men finding stock-brushes and tool and water brushes for building work.

BROOMS.—These are made of split whalebone or metal wires, and are used for keying plaster work, sweeping scaffolds, paving works, &c. They are supplied by the employers.

CALIPERS.—A caliper is somewhat similar to compasses, but has inverted arched legs. It is used for taking the diameter of convex or concave bodies. Hardwood calipers are made with a movable centre, so that the proportions between the points can be altered. They are used for enlarging and reducing. Large calipers and compasses are found by the employers.

COMPASS.—The compass is a two-legged instrument for describing arcs or circles, &c.

CHALK-LINE.—This is a long fine cord fixed on a reel. It is used for forming long lines, &c.

CRADLE.—This is a wood frame made to any desired concave curve, and then lathed and plastered. It is used as a ground in forming, running, or moulding circular work. If the curve is convex, it is called a "saddle."

DRAGS.—These are generally made of thin steel plate, with toothed edges. They are made in various sizes and forms. They are used for dragging surfaces to make them straight or smooth, also to make surfaces rough to give a key for another coat of material. A piece of an old tenon saw about 6 inches long makes a handy drag. A scratch drag is used for keying the back of cast work before the material is set. A useful size is 4 inches long and 2 inches wide. The teeth are made about $\frac{1}{4}$ inch wide, $\frac{1}{4}$ inch deep, and $\frac{1}{4}$ inch apart. A smaller set of teeth are made on the ends for scratching narrow parts. The teeth should be undercut so as to afford a better key.

FILES AND RASPS.—These are made of steel, and are used for finishing running mould plates, and for cleaning up plaster and carton-pierre. Coarse rasps are used for fining concrete work. It is usual for employers to supply files and rasps.

FLOATS AND RULES.—There is quite a family of floating rules, and other rules used for plaster work, all varying in size and form, according to their special purposes. They should be made of well-seasoned pine, free from knots.

ANGLE-FLOAT.—This is from 2 to 3 feet long, 3 to 4 inches wide on each face. It is used for forming internal angles true and square. This float is now unfortunately obsolete.

CONCRETE FLOATING RULE.—This is similar to a parallel rule, and is about 1 inch thick,

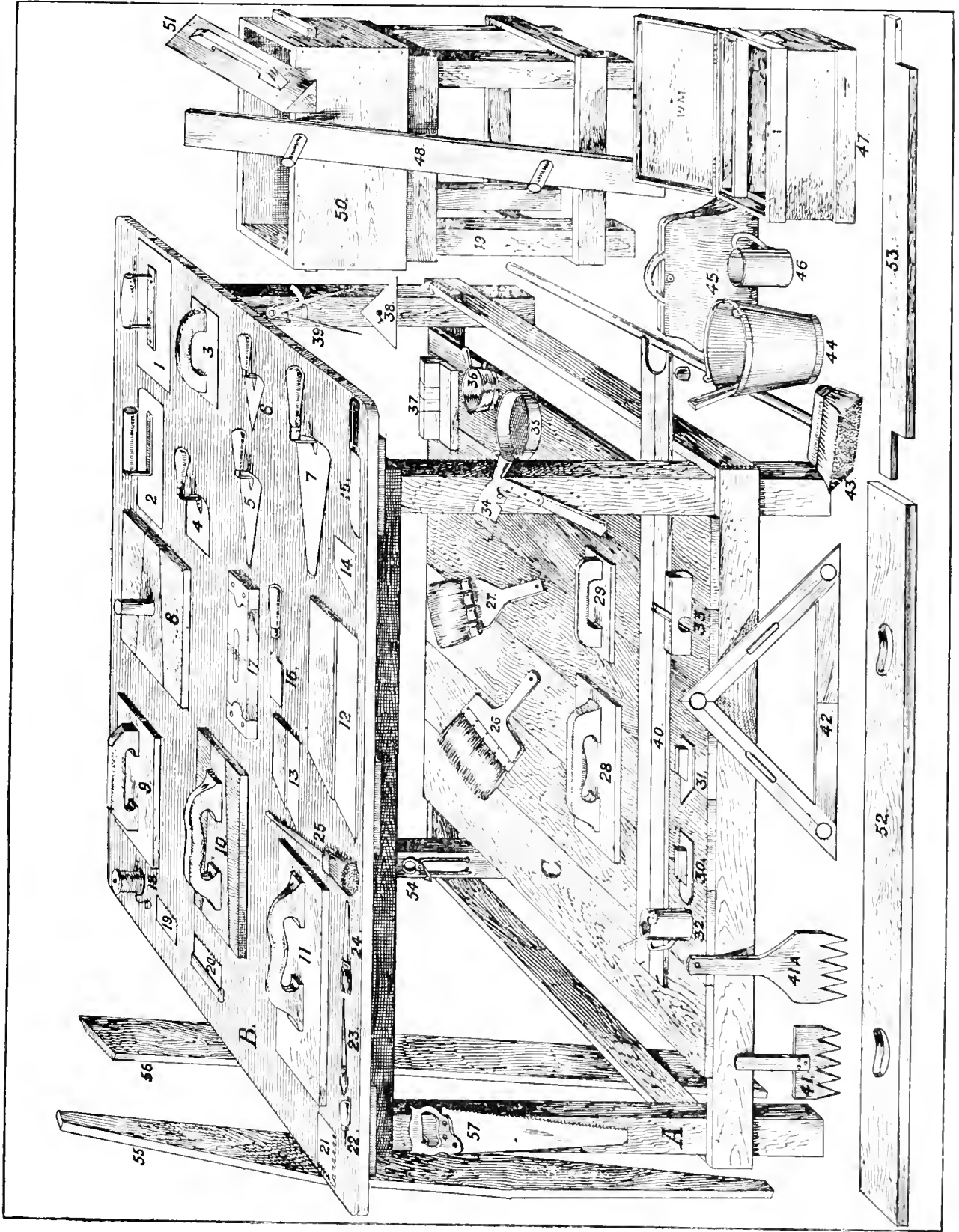

6 inches wide, and in various lengths. Two hand holes are cut on the float to give more power to the worker when floating concrete, which is mostly done by beating with the edge of the floating rule.

DARBY.—This has a blade or sole from 3 feet 6 inches to 4 feet long, 4 to 5 inches wide, and $\frac{1}{2}$ to $\frac{3}{4}$ inch thick. Two handles, each about 5 inches long and 2 inches in diameter, are nailed or screwed on the back of the blade at about one-fourth of the length from each end. The darby is used for floating bays between screeds on walls and ceilings, and in some instances for floating setting stuff to a fair surface, before hand-floating and trowelling. In Scotland it is called a "slack-float." Darbies are generally supplied by employers.

FEATHER-EDGE.—This is of any desired size, but is generally about 5 feet long, 5 inches wide, and 1 inch thick. One end is cut to an angle of 45° ; and one side is splayed until the edge is about $\frac{1}{16}$ inch thick. It is used for working and cleaning out angles, &c.

FLOATING RULE.—This is the principal rule for floating screeds and flanking in bays. They vary in size from 8 to 20 feet in length, 4 to 7 inches in width, and $1\frac{1}{2}$ to $2\frac{1}{2}$ inches in thickness. The back edge is tapered towards the ends. The taper not only decreases the weight, but gives a counterpoise at the middle, thus giving more power to the worker. They are used for forming screeds and ruling off, and forming fair surfaces between screeds.

GAUGE RULES.—These are similar to straight-edges. A double gauge rule has a sinking cut to the desired depth at each end. It is used for forming sunk surfaces. A single gauge has a sinking at one end. It is used for forming raised surfaces, such as the plinth of a skirting.

GROOVED RULE.—Considerable physical strength is required when working a long floating rule, and in some positions it is difficult to hold, and apt to slip out of the hands or cramp the fingers. To prevent these evils, I have introduced an improved rule, called a "grooved rule." This is made like a floating rule, but having a groove on each side. The grooves are made about 2 inches wide, $\frac{1}{2}$ inch deep, and 1 inch from the back edge. The size and position of the grooves can be regulated according to the size of the rule and the requirements of the worker. The grooves give a better grip, and more power and freedom when working. It also decreases the weight of the rule, and if this decrease is only 1 lb., it will make a considerable total weight for the worker to carry or move about during an eight-hours' day. Two holes, each about 1 inch in diameter, are formed in the sides. These prevent the rule from warping, and are handy for hanging it up when not in use. The plan and section of a grooved rule is shown on illustration No. 34 page 159.

PARALLEL RULES.—These are of various sizes. A useful one is 9 feet long, 6 inches wide, and 1 inch thick. They are used for levelling and for setting out parallel lines.

LEVELLING RULE.—This is made by nailing a wood fillet on a long parallel rule. On this fillet a level is placed to act as a guide when levelling ceilings, &c. The elevation of a levelling rule is shown at Fig. 2, illustration 34 page 159.

PLUMB RULE.—This is similar to a parallel rule, but has a centre line, and an opening at one end to allow the lead-bob to work. It is used to plumb walls, &c.

RUNNING RULES.—In Scotland they are called "rods." These are made in long lengths, and about $2\frac{1}{2}$ inches wide, and $\frac{1}{2}$ inch thick, and are planed on all sides and edges. They are used as guides or bearings for running moulds, when running mouldings. They are also used for fences and for a multitude of purposes for scaffold and shop work.

STRAIGHT-EDGE.—This, as its name implies, is any form of rule that has a straight edge. It is used for testing the truth or straightness of walls or other surfaces.

SCREED RULES.—These are made to any desired size, but are generally $2\frac{1}{2}$ inches wide, 1 inch

thick, and in long lengths which are cut as desired. They are used as screeds when laying concrete, also where a square edge or a given thickness is desired in plaster work.

THICKNESS RULE.—These are similar to screed rules, and are used for a given thickness.

TRAVERSING RULE.—This is simply a small floating rule about 6 feet long. It is used for forming screeds of gauged putty, or setting stuff, for running mouldings on. This rule is called a "justing rule" in Scotland, and a "sweeting rule" in the North of England. Employers find all these floats and rules.

HAND-FLOATS.—There is quite a host of hand-floats used for plastering purposes. With the exception of panel and mastic floats, which are made of hard woods, all the other kinds are made of yellow pine, and there are none so well made, or at least so suitable to the worker, as those made by himself. The float most generally used is the hand-float. It is about 10½ inches long, 4½ inches wide, and ¾ inch thick. The cross-grained float is about 11 inches long, 4½ inches wide, and 1 inch thick. The sole is cut with the grain crossways, in order that the sides may cut the work freely and last longer. On the upper surface a dovetailed groove is cut, measuring ¼ inch deep, 2 inches wide at one end, and tapering to 1¾ inches wide at the other. A hardwood bar is made to fit the groove, and on the bar the handle is fixed with screws. The bar strengthens and prevents the sole from warping. Cross-grained floats are used for scouring the setting coat of good three-coat work, and for making angles square and clean. Float soles soon wear thin, and it is desirable to keep a few in stock that they may get well seasoned.

SKIMMING-FLOAT.—This is from 12 to 14 inches long, 4½ inches wide, and ½ inch thick. It is used for laying setting stuff and cements.

PANEL-FLOAT.—This is made of beech, pear tree, or other hard light-coloured wood, which will not stain the white plastic material. The soles are about 6 inches long, 3 inches wide, and ½ inch thick, having the top edges splayed. It is used for laying and smoothing gauged stuff in panels, also for mastic.

FINING-FLOATS are of various sizes, varying from 3 to 6 inches long, from 1 to 3 inches wide, and from ¼ to ½ inch thick. They are used for fining Portland cement mitres, cornices, panels, &c., and where larger floats cannot be used. Workmen find all wood hand-floats.

IRON-FLOATS are usually cast in one piece. They are used for ramming and beating concrete.

GAUGE.—This is a wood measure cut to a given length. It is used for setting out spaces and marks. If there are a number of equi-distant marks required, a gauge will be found more accurate and expeditious than a foot-rule.

GAUGE BOARDS AND STANCES.—These are used as grounds for gauging plastic materials. The boards are generally made about 3 feet 6 inches long, 3 feet 3 inches wide, and ¾ inch thick. Two cross cleats are nailed on the back. A diagonal cleat fixed between the cross ones prevents the board from warping. Stances are used to support the boards. They are made with four legs, each about 2 feet 6 inches high. A top rail is fixed on all sides and flush with the leg tops; another rail is fixed about 6 inches from the bottom. In good stances the lower rail is boarded over, to form a platform as shown at C on Plate LH. to contain tools, &c., when not in use.

Gauging boards for concrete are made about 9 feet square, and 1 inch thick, with strong cross cleats. They are made in two halves, to allow them to be easily moved. The cross cleats project about 6 inches on one side of each half, so that on being laid down the cleats will fit together and keep the halves in position. The halves are sometimes held together with hinges.

GOUGES AND CHISELS.—These are similar to those of wood carvers, and are used for carving, cutting, and cleaning up plaster, cement, and carton-pierre, &c.

GROOVERS AND ROLLERS.—Groovers are of various lengths, the most useful being 2 feet 6 inches long, 4 inches wide, and 1 inch thick. One edge is splayed on both sides into the shape of a flat V. They are made of beech or other tough wood, and some have metal edges. They are used for forming grooves in concrete surfaces. Rollers are made of brass, and have a series of projecting pins. The usual size is about 8 inches long and 4 inches diameter. They are used for indenting concrete surfaces to give a better foothold. Jointers are small rollers about 2 inches long, with a rim projecting about $\frac{1}{8}$ inch on one side, which forms an indent to represent a joint. The roller is made plain or corrugated, as desired. The latter forms a series of marks (similar to chisel-worked stone) on the edges of the concrete slab. The best kinds of rollers, jointers, and groovers are made by A. Gilchrist, of Glasgow. Groovers and jointers being plant, are found by employers.

HAMMERS.—A plasterer's hammer is made with a steel head, one end being in the form of a hatchet blade with a slot for extracting nails, and the other, or driving end, is indented to prevent slipping. A wood handle is fixed into the shoulder of the head. It is used for lathing and general scaffold work. A mounter's hammer, for driving French nails and needle points when mounting composition, carton-pierre, &c., is similar to an upholsterer's hammer. A hammer with a flat round head and a short handle is used for piece moulding. Knapping hammers, as used for breaking stones, are employed for breaking foundation materials for concrete. Knapping hammers are supplied by employers; lathing, mounting, and moulding hammers by the workmen.

HAWK.—This is usually made of pine. The board (on which the stuff is held) is from 11 inches to 12 inches square, and about $\frac{3}{8}$ inch thick. The four sides of the back are splayed about 4 inches wide, so as to leave the edges about $\frac{3}{8}$ inch thick. A dovetailed groove about $\frac{3}{8}$ inch deep, $3\frac{1}{2}$ inches wide, and diminishing in width about $\frac{1}{4}$ inch, is made in the centre of the board, and across the grain of the wood. A bar is made to fit the groove. Though usually made of pine, in some districts beech or other hard woods are used for the bars to give greater strength. The handle is made of pine, and about 5 inches long and $1\frac{1}{2}$ inches in diameter. Sometimes it is turned, having a slight swell in the centre, and a rounded knob at the end. This shape is not so apt to slip from the hand as a straight handle would be. It is fixed on the bar with one thick screw in the centre, which allows the handle to be taken off at pleasure. Another way is to fix it permanently with three fine screws, the heads flush with the bar, so that the bar and handle can be withdrawn in one piece. A hardwood bar, with the handle fixed in this way, will last for three or four boards. A common but clumsy way is to fix the board, bar, and handle in one piece, by driving two or three nails through the face of the boards into the bar and handle. There is a modern hawk, which is called "the hinged hawk." The board is made with the groove as first described. A line is then made longitudinally through the centre of the groove, and cut with a fine saw, thus dividing the boards into halves. A small brass hinge is fixed about 1 inch from the end and flush with the surface of the groove, and another hinge is also fixed at the other end of the groove, thus keeping the halves together, and allowing the board to be doubled up when required for packing. The bar and the handle fixed together are pushed into the groove, which prevents the board from collapsing, and keeps the hawk rigid. A leather or rubber collar fixed on the bar will prevent the hard wood or damp affecting the joints of the forefinger and thumb. American hawks are from 12 to 14 inches square, and in some instances the board part is made of sheet iron, with a wood handle. Hawks should be light, strong, and damp-proof. They are used for holding stuff, and for gauging small portions of stuff. Hawks, being tools, are found by the workmen.

HOD.—The hod, like many other tools, varies in size and form, according to the district in which it is used. The London hod is the smallest, the American one the largest, while the Scotch

one gives the happy medium in size. The box of the London hod measures about 16 inches long, with sides 9 inches deep, and will hold about two-thirds of a cubic foot of mortar, or about 40 hods to the cubic yard. The box of the American hod is about 2 feet 4 inches long, and has sides 1 foot deep. That of the Scotch hod is about 1 foot 10 inches long, and has sides 11 inches deep. The shank varies in length from 3 feet 3 inches to 3 feet 9 inches. It is fixed a little in front of the centre of the box, and a flat round block is fixed behind it, and an angle stay in front. A hod this size will hold, when heaped, 1 cubic foot of mortar, weighing 110 lbs.; therefore if the weight of the hod from 8 to 14 lbs. is added, the labourer carries over 1 cwt. in each load of coarse stuff. One cubic foot of coarse stuff is allowed to this size of hod, which equals 27 hods to the cubic yard. Hods are labourers' tools, but in some districts they are found by employers.

JOINT RULES.—Wood joint rules made of hard wood, such as pear-tree and boxwood, were used for mitring before steel plates were introduced. Where long mitres have to be done, joint rules made of pitch pine, feathered on one side, and one end cut to an angle of 75°, and seasoned with linseed oil, are best for the purpose. They work clean and smooth. The joint rules now in use are made of sheet steel in various lengths, from 3 to 4 inches wide, according to the length, and about $\frac{1}{4}$ inch thick; one end is cut to an angle of about 30°; the acute angle and one side being splayed about one-third of the width of the rule, leaving it moderately sharp, with a straight-edge. Scotch joint rules are made with a thinner plate let in about $1\frac{1}{2}$ inches to a piece of hard wood called a "stock"; generally of mahogany or oak, about 3 inches wide, and $\frac{3}{8}$ inch thick. The stock and plate are fixed together by inserting two or more rivets through the wood and steel. This wood backing or "stock" stiffens the plate, is more agreeable to the touch, and is not so liable to cramp the fingers as when using a thin, cold, steel joint rule.

KNIVES.—Building knife blades are about 6 inches long, trimming knives from 4 to 7 inches long. A small knife about 3 inches long, ground on both edges to a sharp point, is useful for trimming the curves and eyelets of small perforated ornaments. A canvas knife is thin and broad, with a square end, similar to a cobbler's knife. Moulding knives are from 9 to 15 inches long. Composition knives are about 18 inches long, with a handle at each end.

LARRY.—A larry (also called a drag) is a three or four pronged rake with a handle from 6 to 9 feet long. It is used for mixing hair with coarse stuff, and knocking it up for use. A rake is similar to the larry, but has a plain blade instead of the prongs. It is used for making setting stuff, &c.

LEVEL.—A spirit level is the companion to the square and compass. It is, as its name implies, for levelling. Levels are found by the workmen.

MITRING TOOLS.—The annexed illustration (No. 228) shows a set of mitring tools, or "small tools," as they are often termed. Small tools are made of various sizes and shapes out of wrought iron or steel. They are used for mitring, moulding, cleaning out, and stopping ornaments. The principal one has a leaf or spoon-shaped blade at one end, and an oblong square blade at the other. They vary in size from 7 to 11 inches long. The barrels should be octagonal in section and thick at the centre. A round barrel is apt to turn or slip, and a small one to cramp the fingers. No. 1 is a small tool having a square end and a leaf end. This is used for mitring and stopping. No. 2 is a small spade tool having one end square and the other with a trowel or spade-shaped end. This is generally used for laying and pressing the gauged stuff on the back of the cast, and is useful for a variety of purposes. No. 3 is a large mitring tool having a leaf end and a square end. No. 4 is another form of mitring tool having a pointed leaf end and a round leaf end. This is used for mitring, bedding ornaments, and cleaning out hollow members.

No. 5 is a double square-ended small tool used for a variety of purposes. A double square end small tool with one blade $1\frac{1}{4}$ inches wide and 2 inches long, and the other $\frac{3}{4}$ inch wide and $1\frac{3}{4}$ inches long, is useful for laying and finishing narrow spaces, and cleaning out when fixing blocks, also for work where the margin trowel is too large. In former times bone tools hollowed out to fit different sized beads were greatly in use for forming beads when mitring. A few tools with the blade end straight and the other curved, having the edges serrated, are useful for working circular work, or where the plaster is full. They are commonly called "scratch tools."

SCRATCH TOOLS.—Illustration No. 229 shows the form of various scratch tools. No. 1 is a gouge tool generally used for carving mitres of mouldings and cleaning up enrichments. Various forms and sizes of gouges are used in shop work. No. 2 is a double-ended scratch tool curved on section. This is used for working down mitres of enrichments, also circular plaster work. This bent square-ended tool will be found very useful for cleaning up models as well as

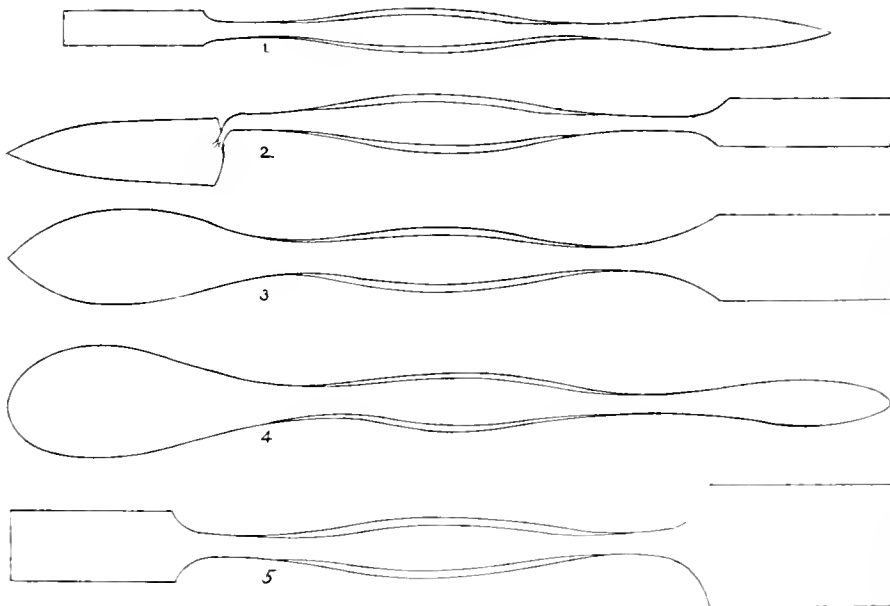

No. 228.—MITRING AND STOPPING TOOLS.

for modelling. This form of tool is also useful for modelling cement or plaster work *in situ*. Nos. 3, 4, and 5 are various forms of scratch tools used for Gothic and circular mitres, and will be found very useful in shop work. No. 6 is a stopping tool having a leaf end and a spear end. One edge of the spear end is serrated, and the other left plain. This is a useful tool for many shop and building purposes.

PAIS.—These are generally made of galvanised sheet iron, and hold about 4 gallons. Wood pails to hold 3 gallons are used in some districts. Putty pails have an extra handle on the sides. It was formerly the custom in London for the men to find pails; now all employers find them.

PINCHERS OR NIPPERS.—These are made of steel. They are used for extracting nails and twisting wire, &c. These are found by the workmen.

RADIUS ROD.—This is a wood or metal rod on which a running mould is fixed at one end and a hole made, or a metal plate fixed at the other. The hole or plate is made to fit the centre

pivot. It is used for running circular mouldings. In Scotland it is called a "gig-stick," and in some districts a "trainer."

PLANE.—Planes are useful for levelling down and smoothing plaster surfaces. The iron or blade should be toothed. Footing or vincer planes are generally used for plaster and scagliola work. Planes are supplied by the employers.

SAWS.—Plasterers' saws are about 18 inches long. They are used for cutting running rules, and mouldings, &c. A fine-toothed saw is best for cutting fibrous plaster. It is customary for employers to find saws for fibrous plaster and shop work.

SCAFFOLDS.—These are temporary structures of timber, clad with boards, for the men to work on, and to place materials and tools on. In Scotland plasterers generally erect their own scaffolds. For ordinary sized rooms the uprights are called "slipheads." They have a slot at the top to receive the needle or transom. The scaffold is clad with battens 7 inches wide and $2\frac{1}{2}$ inches thick. They are placed about 7 inches apart, and it is surprising how few accidents occur in

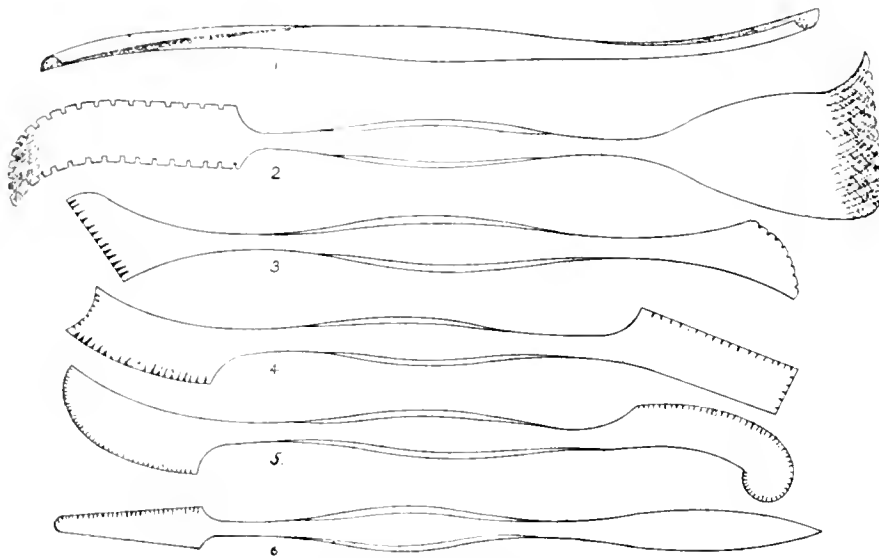

No. 229.—SCRATCH TOOLS.

working on this kind of open platform. In many parts of England they are made by regular scaffolders who are employed by the general contractor. The transoms are tied on poles with cords, and then the scaffold clad with boards each 9 inches wide and $1\frac{1}{2}$ inches thick. They are laid close together, or nearly so. A close scaffold is safer than an open one.

SCRATCH.—The scratch is generally cut out of a pine board, about 14 inches long, 7 inches wide, and $\frac{1}{2}$ inch thick. The teeth are cut about 3 inches long, and the points about $1\frac{1}{4}$ inches apart. A simple but most effective scratch is made by fixing four laths together and then tapering the points. Good and durable scratches are made out of thin metal plates, or strong wires inserted into a wood handle. It is customary for the employer to supply scratches.

SCREENS.—A screen is an upright sieve about 6 feet long and 3 feet wide, with sides 6 inches deep. It is fixed at an angle of about 45° . It is used for screening lime and sand. The materials are dashed against the wires, when the finer parts pass through, leaving the coarser parts on the inside. Screens being plant, are supplied by employers.

PLASTER SMALL TOOLS.—These tools are somewhat similar to mitring tools, and are

used for shop work. A few extra shapes are required for cleaning up originals. Brass small tools are useful for cleaning up plaster, and are generally made by the user. They are made out of brass rod about $\frac{1}{4}$ inch thick. The rod is cut a little longer than the length of tool, to allow for cutting off the split ends, which generally happen while being beaten. The ends are beaten out flat, and then filed to the desired shape. The centre or barrel is filed so as to form an octagon, to prevent it turning round in the fingers while being used. Waxed strings tied round the barrel keep it steady while being worked, and also form a soft easy hold. Illustration No. 230 shows a set of plaster or shop small tools used for working plaster. They are made principally in Paris, where they are extensively used for general shop work.

SIEVES OR RIDDLES.—These are made in various sizes and fineness, according to the material and purpose. They are used for running and riddling lime, and washing sand. A riddle-rest is used in some districts to carry the weight of the riddle and lime. It is rapidly moved backwards and forwards by one man while another fills it, and as the lime forms in heaps, they move back a little, and so on until finished. Putty sieves are made with a fine wire or hair mesh, fixed on a round or square wooden frame. Two handles are fixed on the frames. "Punching sieves" are used in some districts for making setting stuff. They are constructed with a wooden frame about 2 feet square and 7 inches deep, on which a strong fine steel wire mesh is fixed. A wooden punch, somewhat like a large hand-float, to admit of both hands, is used for punching the putty and sand through the mesh into a tub on which the sieve is placed.

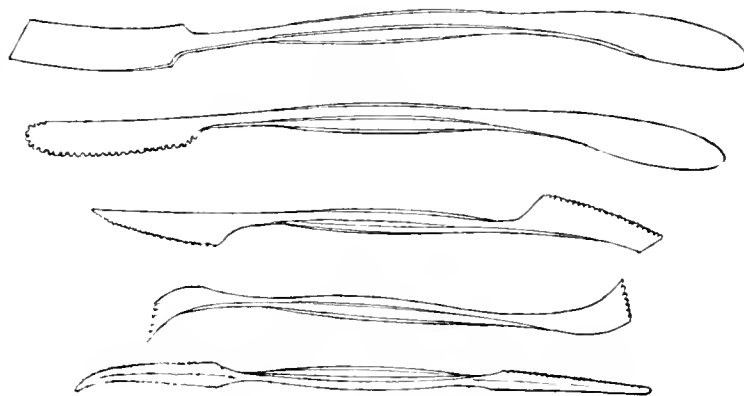

NO. 230.—PLASTER SMALL TOOLS.

SQUARES.—These are made of wood or iron, and of various sizes. A handy size is one about 1 foot on each square edge. They are triangular in form, and the 45° angle is useful for giving mitre joints. They are sometimes made with a level, or a small plumb-bob, or with both, and are useful in forming small works plumb and level. A small one, about 6 inches, is useful for return mitres, &c. Wood squares, about 3 feet, are required for large work on ceilings, shop, and flooring work. It is customary for employers to find large squares, and the men small ones.

TEMPLATES.—These are circular running rules and screeds. They are cut out of one or more pine boards to the desired curve. Plaster templates are used for running clay profiles, &c.

TOOL BOX.—This is for keeping plasterers' tools, overalls, cap, apron, &c., clean and safe. They are usually made about 18 inches long, 14 inches wide, and 12 inches deep (all inside measurements). A movable tray 5 inches wide and 2½ inches deep, placed on runners inside the box, is useful for holding small tools. The box is usually carried by the aid of a strap fixed to the handles. American cloth bags are also used for keeping tools. In some districts the tools are simply tied up in an apron.

TROWELS.—Trowels are of various shapes and sizes, each one having its own special use. The most important of its kind, and constantly used tool for plaster work, is the "laying trowel." Tyzack, of London, is a noted maker of plasterers' tools, his trowels being in general use throughout the United Kingdom.

LAYING TROWELS are about 10½ inches long and 5 inches wide. The plates are made of the best steel, light and flexible. The "shank" is riveted on to the plate with three, and sometimes four rivets. Some trowels have two shanks (without fangs), one at each end, made with a flat round head with a countersunk hole, to receive screws, or a long rivet.

POLISHING TROWELS are half-worn laying trowels. The edges should always be straight and parallel, or nearly so. Parallel edges work truer than tapered edges.

THE MARGIN TROWEL is similar to a gauging trowel, but the edges of the blade are parallel, and the end cut square. The blade is about 3½ inches long and 2½ inches wide. The handle is shorter than that of a gauging trowel. It is used for laying and polishing margins, styles, or spaces where a larger implement could not be employed.

THE ANGLE TROWEL is a novel tool for finishing internal angles. It was invented by the late R. Millar, my brother. It is similar in form to a margin trowel, but having about 1 inch of the two side edges of the blade turned up at right angles to the blade, and perfectly square. The points of the turned up sides are cut to an angle of 45°. R. Millar was well known in the trade, and noted for his large and varied collection of tools, which numbered nearly five hundred.

THE PANEL TROWEL is similar to a laying trowel, but the blade is thin and springy, and is about 5 inches long and 3 inches broad. The handle is slightly shorter than that of a laying trowel, to allow it to be easily worked in small and deep panels. A good panel trowel can be made out of an old laying trowel. It is used for setting small panels.

GAUGING TROWELS are of various sizes, but the most useful is one, the blade of which is about 6 inches long and 3 inches wide at the heel or handle end, and tapering to a narrow point at the other end. The shank and blade are sometimes made separately, and riveted together, but more often they are forged in one piece. The wooden handle is bored to receive the fang of the shank, and partly filled with powdered resin and plaster. The fang is made hot and pushed in, and the heat melting the resin, it forms the plaster into a strong cement, securing the fang and handle together. Gauging trowels are used for gauging small portions of stuff on the gauge board, or on the hawk, and for laying stuff on mouldings, mitres, &c.

THE LAYING GAUGING TROWEL is nearly of the same shape, but much larger than the ordinary gauging trowel. The blade is from 7 to 9 inches long, and from 3 to 3½ inches wide at the heel end, and tapering until from 1½ to 2 inches wide at the point. It is used for laying gauged stuff on large mouldings and for bedding large plantings. The small gauging trowel is generally an old one which has been worn small, and ground to a sharp point. It is used for stopping small holes, scraping and cleaning rules, &c. The handles of gauging trowels are generally made of ash, with deep brass ferrules. They were formerly made of mahogany or ebony.

TUBS.—These vary in size according to requirements. They are used for holding water, washing sand, slaking lime, &c. An old spirit cask cut in half, makes good tubs.

PLASTERERS' PLANT, LABOURERS' TOOLS, AND SCAFFOLDING.—The annexed illustration No. 231 shows plasterers' plant and labourers' tools. No. 1. Scaffold trestle, also used as a hod-stand, as shown. 2. The hod. 3. Putty pail. 4. Shovel. 5. Larry for coarse stuff. 6. Water-tub. 7. Riddle-rest. 8. Putty sieve. 9. Sand-screen. 10. Sliphead. 11. Putty slack box. 12. Banker. 13. Putty rake. 14. Hawk-boy's server. This tool is now obsolete, and is only given as a relic of the past.

CLEANING PLASTERERS' SMALL TOOLS.—Plasterers generally clean their small tools by rubbing them with a piece of wood dipped into setting stuff or brick dust. This keeps them bright, but it wears them out far more than the working with them. The rubbing also scratches the

surface, and spoils the edges. They should always be cleaned, when done with for the day, or when the job in hand is finished, by wiping them thoroughly dry. Rust destroys them, and it takes twice as much labour to get them bright again. If the tools are always dried as soon as done with, they will keep a better surface. Small shop tools for cleaning up with, can be kept clean and smooth, and they will have a nice dark blue polish, by simply scraping or rubbing the plaster or clay off with the back of a knife. The barrels or thick centre parts of all small tools should be kept clean in some simple way. Some plasterers temper and get a dark blue on their small tools by holding them over a red-hot iron until blue, then dipping them into linseed oil. If the tools are properly made at first, they require no tempering. Many industrious plasterers make their own small tools out of old files, or fencing foils. A beautiful deep black polish can be given to all small tools, whether bought or home made, by boiling 1 part of sulphur in 10 parts of oil of turpentine,

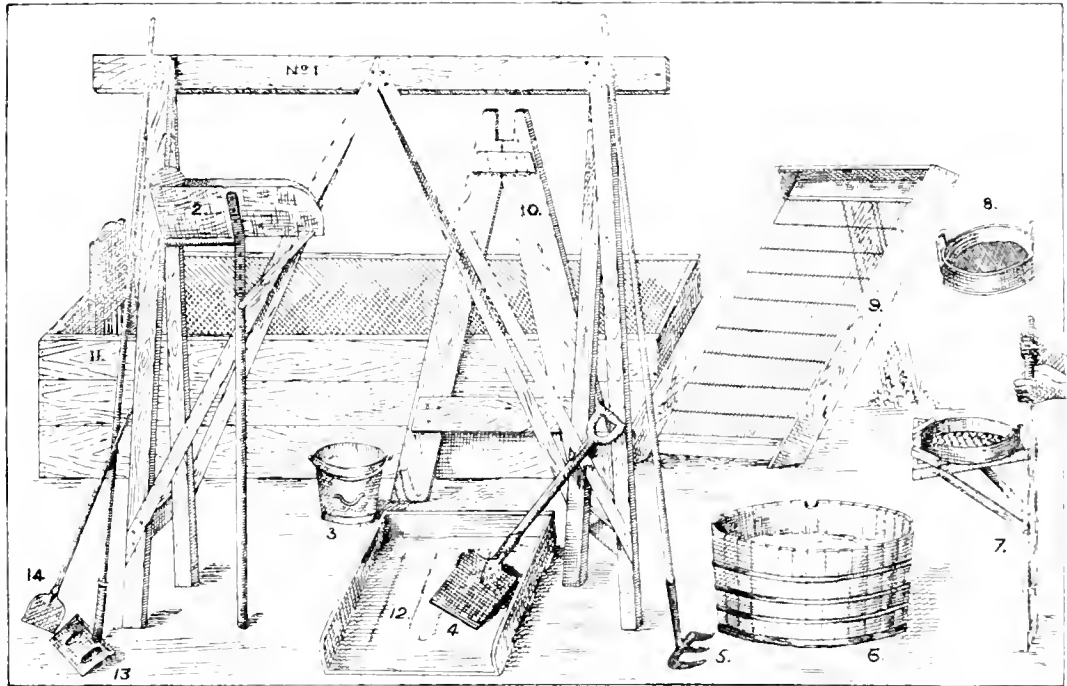

No. 231.—PLASTERERS' PLANT AND LABOURERS' TOOLS.

which produces a brown sulphurous oil. The tools are warmed and brushed over with the hot solution as slightly as possible, and heated over a spirit lamp or slow fire until the required black polish is obtained. Small tools done in this way should not be scrubbed, only wiped clean and dry after using.

THE PLASTERERS' COMPANY.—The Worshipful Company of Plasterers was incorporated in 1501. King Henry VII., by his charter, dated 10th March, incorporated the Worshipful Company of Plasterers under the title of "The Master and Wardens of the Guild or Fraternity of the Blessed Mary of Plasterers." Their grant of arms by Thomas Hawley, Clarencieux, is dated 15th January 1546. A confirmation of their charter of incorporation, dated 11th June 1667, grants them the usual privileges of a guild: a livery, a master, two wardens, and thirty-two assistants.

Their arms are "Azure on a chevron *gules*, between a trowel and two hatchets, handles of the second; headed *argent* in chief, and a treble brush in base proper; a rose *gules* seeded *or*, between

two fleurs-de-lis of the first." "Let brotherly love continue" is their motto. Their book of ordinances is an interesting volume. In 1686 occurred one of those "prentice" riots so famous in the old time, and five of the prisoners proved to be of the Plasterers' Company. By an Act passed in the sixth year of William and Mary, 1694, it was ordered that "whereas the Masters and Wardens of the guild or fraternity of the Blessed Mary of Plasterers, London, are, and very anciently have been, a brotherhood or guild, and for confirmation or strengthening of their privileges have obtained several royal grants, whereby their original constitution the said fraternity or guild ought to be and consist of all persons using the trade of a plasterer in the city of London and liberties thereof"—a fine being inflicted on those practising the art without being a member. A statute was passed in the first year of the reign of James I., 1603, c. 20, which enacted that no plasterer should exercise the art "of a painter in the city of London or suburbs of London," but an apprentice was exempt from the meaning of the Act. The penalty was £5, but a proviso allowed the plasterers to use whiting, blacking, and red ochre mixed with size, without oil. This was a very important statute, for it at once cleared up the several disagreements existing in 1575 between the plasterers and the painters, the latter retaining their privileges by becoming incorporated in 1581.

The plasterers do not appear to have restricted themselves to the mystery of pargeters. In 1579 and 1585 two orders were made by the Court of Aldermen for settling matters in dispute between the tilers and bricklayers and the plasterers, as to interfering in each other's trades. The observance of these orders was enforced by an order of the Privy Council, dated 1st June 1613, and a general writ or precept issued to the same effect on 13th August 1613.

The Plasterers' Hall is situated in Addle Street, Wood Street, Cheapside, London. Unfortunately it is now used as an office and warehouse. Malcolm, who wrote in 1803, states that the rooms were much ornamented with work peculiar to their profession, and the best artists belonging to it were doubtlessly employed. Among the plasterers is found the name of Mr T. Brewer, author of "The Life of John Carpenter," and "The Life of the late Alderman T. Kelly," citizen and plasterer of London, and Lord Mayor 1836. J. Pirie, a member of the Plasterers' Company, was a Sheriff of London in 1833. The members of the Company are not now of any particular trade. About twelve plasterers are members of the Company. Only one apprentice has been bound under the auspices of the Company during the last two decades. The Company has distributed for several years £25 per annum in prizes to workmen in the trade, who become candidates for them at the Technical Examinations at the City and Guilds of London Institute, and spend £15 per annum in photographs and casts of the prize models, for distribution to Schools of Art.

THE PLASTERERS' CRAFT.—The plasterers' craft is one which shows the individuality of the workman's touch, an essential feature, a desideratum justly regarded as a matter of high importance at the present time. It is a craft entirely independent of machinery, demanding some exercise of brain as well as skill of hand. There was once an American invention for executing plaster work by replacing the hawk and trowel by a machine, but its labours ended at the Patent Office. In every art or craft a perfect knowledge of the materials used, of their characteristics and applicability to various purposes, is absolutely needful to ensure a satisfactory result for labour expended. The plasterers' craft forms no exception to this rule. Many lamentable results have ensued from want of attention in some instances, and ignorance in others, hence the need of care and knowledge of the properties of the materials used. There have been many new plastering materials introduced during the last few years, claiming fireproof, waterproof, strength, and sanitary properties, which are herein described. London, with its 10,000 plasterers, is about the worst town in the United Kingdom for the employees. It is true they receive the maximum wage, but owing to the inter-

mittent character of employment, high rents, and railway fares to far-off and ever-changing placed jobs, their wages are practically reduced to the minimum. The time expended going to distant work and returning to their homes, added to the actual working hours, makes a long and tiring day, leaving but little time for rest, recreation, or self-instruction. Another evil which has cropped up of late years is the system of sub-contracts, by which builders sublet their work to "piece-masters" who contract for "labour only." Builders who sublet their work supply plant and materials, and as no other trade offers greater facilities for the adulteration of materials, there is often adulteration to the extent of 30 per cent. Adulteration, scamped work, and cheap unskilled labour, all combine to bring plaster work into bad repute, and cause serious injury to the trade. Adulteration of materials should be made a penal offence, the same as adulteration of food. Adulterated materials are often the cause of insanitary and unsafe buildings, and are also a loss to the owners, and an injustice to the manufacturers of genuine materials.

There are many builders who have little, or more often no knowledge of plaster work, or of the individual merits of their workmen, and simply trust to the foreman for the execution of the work. In many instances the foreman is selected not for his superior knowledge of the trade, but for his "gift of the gab," or his powers of driving and extracting the utmost amount of work out of the men. If a foreman is conscientious, and has the courage to act fairly between master and man, he is liable to be bullied, badgered, and driven by the builder's general foreman. In London the various branches of the building trade (a few special or patented branches being excepted) are carried on by a master builder, and are under his control.

In most provincial towns there are fewer trades combined under one head, and the farther north one goes the combination gets less and less, until each trade has a separate place and head which finds all plant and materials. The division of trades creates a master or a master workman for each trade, who, by concentrating his powers on his own special duties, is enabled to produce sounder and better finished work than if he had to study and supervise six or seven trades. The master plasterer having a fair business has a reputation at stake, and uses his practical knowledge to protect it. In doing this he expends more time, and has greater intercourse with his men, which generally leads to a better understanding between each other. He can also discriminate between the skilled and the unskilled man. Provincial master plasterers have permanent shops and a regular staff of men and apprentices, but in London, the richest, greatest, and most populated town in the world, there are not a dozen legitimate master plasterers who have shops and apprentices. This number does not include the firms engaged in the special production of fibrous plaster, carton-pierre, papier mâché, and scagliola. Of these there are about half-a-dozen firms, and there is a similar number of Italians who supply jerry-builders with plaster cast work. A few of the London builders do their own plaster work, and retain a regular staff of shop and building plasterers. The London trade is principally recruited from the provinces. A London apprentice has during the last generation become unknown. It is true that a few plasterers' sons learn the trade, but they do not serve a regular apprenticeship, and move about to where the largest wages are obtainable, and are often paid by their stature, and often before they attain their majority they develop into full-blown plasterers. Benjamin Franklin says, "Good apprentices are most likely to make good citizens." Good apprentices also make good workmen, and good workmen make good masters.

The mention of bricklayers with plasterers in some of last century's records shows that there was a combination of the two trades in some parts of the country. Aspdin, the inventor of Portland cement, was a bricklayer and plasterer. In some parts of the North of England even at the present time plasterers are to be found who are also stone builders or "wallers," and in the

North of Scotland the plasterer has generally some indoor trade for the winter months, such as lath-rending, &c. The extracts as to whitewashing already quoted, and the prices mentioned therein, prove that plasterers formerly had this branch of business in their own hands. How they gave this up or lost it there is no evidence to show, but I have heard old plasterers say that when trade was good they did not care about taking up whitewashing, and that consequently it gradually fell into the hands of the painter. There are a few places where plasterers still do whitewashing and lime-whiting. The red letter days of plasterers as regards wages were in 1876-77 at Glasgow, when wages reached as high as 1s. 3d. per hour, and in some instances 1s. 6d. All sorts and conditions of plasterers flocked from London and other parts to that short-lived *El Dorado*.

In London and the South of England plasterers formerly had attendants called "hawk-boys," each pair of plasterers having one to wait upon them. The hawk-boy's duty was to knock up and gauge all the materials, keep the men's tools clean, look after the warming of their meals, and serve the materials when gauged. The materials were gauged in a banker, which was placed on the floor or scaffold, as the case might be. The boy gauged the materials with a "server," and when he had finished the gauge, shouted "serve," and lifted as much as would fill the plasterer's "hawk." If the plasterer was on a mid-scaffold, a smart hawk-boy could throw a serverful of stuff quite 10 feet high. Their wages were from 2d. to 2½d. per hour, and the plasterer also gave them a few coppers on pay-day as tool money. When the Foreign Offices were being erected, nearly a hundred boys turned out on strike for an advance of wages. Hawk-boys are now a thing of the past, and it may be said that it is better for the trade that it is so, because as the boys grew up, knowing the names and uses of the tools, a smart boy soon developed into a so-called plasterer, and the market became swamped, to the detriment of the workman who had fully and faithfully served his apprenticeship.

Sweating is not supposed to exist, but something nearly akin to it does, happily only to a small extent at present. Some of the Italian figure casters now make plaster enrichments of the sort used by jerry-builders. They also hawk about centre-flowers and trusses, which are chiefly bought by small decorators and jerry-builders. Some of these plaster casters have a new method of supplying the jerry-builder. They take old stock-moulds on to the job (where the builder fits up a temporary bench in one of the rooms), and cast the enrichments there, thus saving the expense of packing and carriage of the ornaments. It is needless to say that the jerry-builder supplies the materials, and that the caster has only the price of his labour. Another form of sweating has arisen since the introduction of the demon "piece-work" labour only, especially for jerry-builders. A plasterer commonly termed a "field-ranger" gives a lump sum to plaster a row of cottages, the draws for wages to be paid weekly. He then employs the cheapest labour he can find, to help him in doing the work. They sometimes work so hard that they do "sweat." Quality is ignored, quantity is their aim, and the only chance of gain. In some instances the piece-worker has to work all hours, early and late, before he can make a week's wage for himself, and he sometimes succeeds in overdrawing so much, that to finish the job would only be thrashing a dead horse. So he quietly leaves, and seeks fresh fields and "plasters" new.

Few plasterers attain civic honours, but Mr Ralph Dodds was once Mayor of Newcastle. "Raffie," as he was generally called, arrived in Newcastle with the proverbial "tuppence" in his pocket, and worked his way up from journeyman to master, and eventually to the Mayoralty. He was of a humorous turn of mind, and many anecdotes are told of him. The following one as connected with the trade will serve as an example. A certain lime merchant, being hard pressed for

money wherewith to pay his men, called on Raffie for payment of an account which was scarcely due. He stated his case, and was impatient as the hour for bank closing was near. Now it so happened that years before, when Raffie first started business, this same lime merchant was a clerk in a lime merchant's office where Raffie had credit. This clerk used to worry Raffie as to the payment of his lime accounts. This was not forgotten when Raffie signed the cheque, which he handed over to the merchant, who at once rushed off to the bank, only to find that they would not cash it, because after the signature came the two imposing letters M.P., and the bank clerk stated he did not know any R. Dodds, M.P. The merchant being utterly dumbfounded, could not explain, so he rushed back to Raffie, who fully expected him, and after quietly listening to his sorrows, told him that he was an adjective fool, and that he ought to know that M.P. stood for Master Plasterer as well as for Member of Parliament. Raffie, with his usual good-nature, then told him the reason why he had added the two letters after his signature, and gave him the amount in hard cash, with the advice never to be unduly hard on new beginners in business.

C. Fortune, a Harrogate plasterer, has also obtained civic honours, having been twice Mayor of Harrogate; he also holds the dual positions of Borough and County Justice.

According to the last census, there are no less than 34,905 plasterers in the United Kingdom, of which there are about 10,000 in London, 1,000 in Glasgow, and about 300 in Dublin.

Novel and varied as may be the uses to which plaster work has been and may be applied, it is regrettable that the craft is so unremunerative, that it almost ceases to enlist the skill and intelligence of both master and operative men that the craft should command. This is mainly due to the want of appreciation by the general contractor or builder, who is tempted by the questionable economy of subletting the work to men of no mechanical standing. Another undeniable factor is a want of early technical training in the nature and application of plastic materials. It is hoped that the day is not distant when a general system of apprenticeship will be re-established, and that it will be required of the artisan to provide himself with a proper and authorised certificate of ability.

No one can look round on the condition of the trade without being impressed with the fact that a great change for the better is required. How this is to be accomplished no one can accurately say. It may be done partly by individual effort, partly by co-operation, and partly by legislation. Competition between employers in London and other large towns, the constant effort to undersell, cheap labour, bad materials, the adulteration of good material with inferior, the insufficiency of materials (notably hair lime and good sand), and the general scamping of work, have brought discredit on the trade. Good materials and work are spoilt by careless or incompetent workmen, or by want of proper supervision. The bonds of good fellowship between employers and employed should be broader and closer, to ensure mutual success and to avoid failures, although failures are frequently the first steps towards success, and it may be truly said that the man who never made mistakes never made anything.

With regard to plastic literature, it is a remarkable fact that although all other branches of the building arts and crafts have been treated of in special works, that of the plasterer has not been represented in technical literature. Some authors have slightly treated of the plasterer's craft in connection with building construction, or in Encyclopædias of Architecture, but most, if not all, authors, when describing plaster work, make many palpable mistakes. It is probable that the writer who first introduced the subject as a part of his work was so engrossed with his own particular branch that he could not give plaster work due attention, or that, aware of his want of plastic knowledge, he left the subject to some careless underling, who was either

incompetent to give reliable information, or in his search for information was imposed upon, and in turned imposed upon his employer. Other authors or would-be teachers of plaster work blindly followed, like a flock of silly sheep following a leader. Only recently the Plasterers' Company offered a series of prizes to plasterers' apprentices for the best description and examples of about a dozen branches of the plasterers' craft, and as many of the branches named were new, the students were referred to a well-known work on Building Construction. On referring to this work, a few short notes are to be found, which are not only insufficient, but wholly incorrect and misleading. It would take up too much space to enumerate even one-fifth of the errors, but the following are fair samples. It is stated that "trowelled stucco is laid in pieces about 4 or 5 feet square, and the workman, with a float in one hand and a brush in the other, floats the work until it is as smooth as *glass*." Now it only requires a modicum of intelligence or thought to see that it is impossible to get a partly soft or moist surface as smooth as glass with a wood float. Of course the work is scoured with a hand-float, but it is the hard, smooth, and straight edge of the trowel that gives the polish and renders the surface as smooth as glass. Again, laying the work in small pieces is entirely wrong. In fact, it is never done by plasterers in the manner described. If laid in small pieces, it would make a series of joints, which would be unsightly and difficult to make smooth and true. Floating is described as "consisting of fine stuff with the addition of a little hair, and derives its name from being laid on with *floats*." Now a novice knows that floating consists of coarse stuff, and that it is laid on with a laying trowel. It derives its name from the fact that it is a second coat "floated" on the first coat, to form a solid straight surface for the setting coat. Another reason for the name is that the surface is made straight (not smooth) with a floating rule. It is also stated that "common stucco is laid on with a brush like whitewash, smoothed with a straight-edge, and then rubbed with a hand-float, and brought to a hard and glossy surface." I have been in the trade, and a seeker of plastic knowledge, for over forty years, and I have never seen or heard of laying setting stuff with a brush (instead of a trowel or skimming-float), or of smoothing being done with a straight-edge. This is used, as its name implies, to make the surface straight. As to the glossy surface, it is done with a trowel, not by a float. It is by the contact and friction of two hard surfaces—the consolidated setting stuff and the trowel) that the gloss or polish is obtained.

The term "fine stuff," which is used by some authors for "setting stuff," should be entirely discarded. There are several degrees of fineness in most plastic stuffs, such as coarse, fine, and superfine plaster; coarse, fine, and superfine Keen's. Even in "coarse stuff" there is often a finer quality used for floating ceilings (especially for panelled ceilings) than what is used for lathed walls, and rendering, first-coating, &c. Therefore, the term, as applied to "setting stuff," is vague and often misleading, especially as there are several degrees of fineness in this stuff, such as coarse, common, and fine, which are used for different kinds of setting and stucco work. It seems ridiculous, or like gilding gold, to name the finest degree of this stuff as fine, fine stuff. Fine stuff is described by some authors in their passing remarks as "slaked lime saturated with water until of the consistency of cream . . . for some purposes a small quantity of hair is added." Now the veriest tyro will see that this is simply lime putty. No mention of sand is made. Lime putty is described as similar to fine stuff, but always used without hair. Even in lime putty there are two degrees of fineness—the ordinary run lime, used for coarse stuff, and the fine putty used for running mouldings and making setting stuff. Hence the necessity for the general use of the term "setting stuff," and the denomination of the other degrees of fineness, as fine or coarse, as required for the class of work.

Some authors also speak of "coarse gauged stuff," whereas it should be gauged coarse stuff. The stuff may be of different degrees of fineness, but the gauging can only be medium or strong

gauged, *i.e.*, using more of the material which has setting powers. The gauge may also be stiff or soft, but not coarse gauge. This then would rather imply that it was carelessly or improperly done. Coarse stuff is a term solely applied to the material used for the first and second coats of lime plastering, or when coreing or roughing out work with coarse plaster. Coarse or rough may be correctly applied to denominate the degree of fineness of any material, such as coarse plaster, &c.

One instance will suffice to prove that the descriptions of tools are also inexcusably wrong. A "darby" is described as being worked by two men. Just fancy, two men working a tool about 3 feet 6 inches long, and only weighing about 3 lbs. One author gravely asserts that a spade or shovel is one of the principal tools used by plasterers. This is an infringement of the labourer's rights.

The prices for plaster work in most books are vague and valueless. One writer gives a half-hearted excuse and a lame reason for his want of practical information, stating that he "had not been able to obtain sufficient data for carrying them out (constants for the value of plaster work), which, from the minor importance of this branch of building, is perhaps of no great importance." Every class of building work is of importance, and every class of work that has to be paid for should have a value. That such gross carelessness and incompetency could be shown by a professed teacher is hard to believe, and that this teaching should be blindly followed by other theoretical writers, and given in works of reference, is still harder to comprehend. They may suit from a theoretical point of view, but they will not stand a practical glance. Insufficiency of details or description (if correct) may be pardoned, but for ignorant or careless errors there can be no excuse.

In 1829, a book entitled the "Bricklayers', Plasterers', and Slaters' Manual" was published, but the information anent plastering is meagre and somewhat misleading. Recently a work has been published on plastering, which claims to be written by a plasterer, but by no stretch of imagination can one think that it has been written by a practiser of the art of plastering. Amongst a host of erroneous statements one may be mentioned, which will demonstrate to the veriest tyro the improbability of this self-called plasterer ever having been connected with the craft, *viz.*, among the tools illustrated is one which is, to all intents and purposes, a plumber's "shave-hook" (a triangular piece of steel with a wooden handle), but it will scarcely be credited that this so-called plasterer calls it a "jointing tool," and says that "it is employed for picking out and finishing off angles and mitres to mouldings." In the same work it is stated that a darby is "about 12 feet long, with a flat smooth face and a pair of handles, so that it can be operated or worked by two men." This, combined with numerous and gross blunders in the methods of using the materials, proclaims the author ignorant of the plasterers' craft.

APPENDIX.

QUANTITIES OF PLASTIC MATERIALS REQUIRED FOR VARIOUS WORKS—CONCRETE QUANTITIES—WATER QUANTITIES—WEIGHTS OF MATERIALS—CHEMICAL NAMES—MEASURING PLASTERERS' WORK—SQUARING DIMENSIONS—RECIPES FOR INDURATING, FIREPROOFING AND WATERPROOFING, AND POLISHING PLASTER—CLEANING PLASTER FIGURES—WHITEWASHING—DISTEMPERING—GLOSSARY OF ARCHITECTURAL AND PLASTIC TERMS, &c.

I.—PLASTERERS' MEMORANDA, QUANTITIES AND WEIGHTS.

WEIGHTS AND CUBIC CONTENTS AND QUANTITIES OF MATERIALS REQUIRED PER SUPERFICIAL YARD.

LATHS.—Length, from 2 ft. 6 in. to 4 ft.
Width, about 1 in.

Thickness—"Single laths," $\frac{1}{4}$ to $\frac{3}{16}$ in.
Lath and a half, $\frac{3}{16}$ to $\frac{1}{4}$ in.
Double laths, $\frac{1}{4}$ to $\frac{3}{8}$ in.

125 laths 4 ft. long = 1 bundle.

A bundle contains from 360 to 500 ft. run, most frequently the former number.

30 bundles of laths = 1 load.

Laths are usually spaced from $\frac{1}{4}$ to $\frac{3}{8}$ in. apart, according to their strength and nature of plaster.

A bundle containing 360 ft. run (or 400 nominally), nailed with butt joints, will cover about 4½ superficial yards.

A bundle of 3-ft. laths requires about 660 nails, and one of 4-ft. laths 630 nails, if nailed on to joists 1 ft. from centre to centre.

Lathing nails are from $\frac{3}{4}$ to 1¼ in. long, according to the thickness of the laths. They are either wrought, cut, or cast iron, and they should be galvanised for white cement work.

About 350 $\frac{3}{4}$ -in. cut nails = 1 lb.

1,000 laths and 11 lbs. of nails will cover 70 superficial yards.

A bundle of laths and 500 nails will cover about 5 superficial yards. Sawn laths are generally used in America. They measure about $\frac{1}{4}$ in. thick, 1¼ in. wide, and 4 ft. long.

HAIR.—A bushel of dry hair weighs from 14 to 15 lbs. For best work, 1 lb. of hair is allowed to 2 cubic ft. of coarse stuff, and 1 lb. to 3 cubic ft. for common work.

A barrel's bulk is 5 cubic ft.

PLASTER. 14 lbs. (London style) = 1 bag.
7 bags = 1 bushel.
1¼ bush. = 1 cwt.
2 cwt. = 1 sack.
10 sacks = 1 ton.

PARIAN CEMENT. Four bushels of cement, gauged with an equal quantity of sand, will cover 10 superficial yards $\frac{1}{2}$ in. thick.

1 sack of Parian = 2 cwt.

1 cask of Parian = 2½ cwt.

KEEN'S CEMENT. A cask contains 4 bushels, and when gauged with sand in the ratio of 1 part of cement to 2 parts of sand, will cover about 15 superficial yards $\frac{1}{2}$ in. thick. One sack of Keen's = 2 cwt.

MARIN'S CEMENT. One cwt., gauged with equal proportions of sand, will cover about 7 superficial yards $\frac{1}{2}$ in. thick.

ROBINSON'S CEMENT. One cwt. of cement and 1 of sand will cover 7 superficial yards $\frac{1}{2}$ in. thick. One cwt. of cement and 2 of sand will cover 11 superficial yards $\frac{1}{2}$ inch thick. One cwt. of cement and 3 of sand will cover 15 superficial yards $\frac{1}{2}$ in. thick. One cwt. of neat cement (No. 1) will cover 15 superficial yards $\frac{1}{2}$ in. thick. These proportions are by measure, not weight. One cwt. cement equals about 1½ imperial bushels.

ADAMANT. Adamant (No. 2) for floating walls, weighs 155 lbs. per sack, and will cover 7 superficial yards. Adamant (No. 2) for floating laths, weighs 130 lbs. per sack, and will cover 7 superficial yards. Adamant (No. 3) for setting coat, weighs 140 lbs. per sack, and will set 30 superficial yards.

SIRAPITE.—One ton mixed with an equal portion

of sand will cover about 120 superficial yards $\frac{3}{4}$ in. thick: 1 ton of pure sirapite will cover about 300 superficial yards.

GRANITE PLASTER. 1 $\frac{3}{4}$ tons of render on "sawn laths" will cover about 100 superficial yards $\frac{1}{2}$ in. thick, and 1 ton of X or finish will cover about 300 superficial yards.

RESIN'S ADAMANTINE PLASTER. For wall work an admixture of 1 part sand to 2 parts adamantine is allowed for a floating coat, which is skimmed with pure adamantine only. No admixture of sand is allowed for ceiling or lath work.

One bag of pure adamantine (180 lbs.) will cover about 6 superficial yards.

Wall work in Birmingham is done (including labour and all material) at about 10d. per yard.

Ceiling work in Birmingham (including labour, lathing, and material) is done at about 1s. 5d. per superficial yard.

MASTIC. One cwt. of mastic and 1 gallon of oil will cover 5 superficial yards $\frac{1}{4}$ in. thick.

FIBROUS PLASTER SLABS. Slabs $\frac{1}{2}$ in. thick weigh when dry 2 $\frac{1}{4}$ lbs. per superficial ft. Fourteen lbs. of nails will fix 100 superficial yards.

GELATINE. Two lbs. of gelatine when dissolved will cover about 1 superficial foot $\frac{1}{2}$ in. thick.

WAX. 5 lbs. of moulding wax will cover 1 superficial foot about 1 in. thick.

SILICATE OF COTTON. One cwt. will cover 100 superficial feet about 1 in. thick.

LIMEWHITE. Limewhite once done requires 1 cubic foot of slaked lime per 100 superficial yards; twice done, 1 $\frac{1}{2}$ cubic feet of lime.

WHITWASH. 100 yards superficial "once" done requires about 12 lbs. of whiting, $\frac{1}{2}$ lb. of blue-black, and 1 $\frac{1}{4}$ gallons of size.

100 yards superficial "twice" done requires 21 lbs. of whiting, $\frac{3}{4}$ lb. of blue-black, and 2 $\frac{3}{4}$ gallons of size.

- 1 firkin of double size = 48 lbs.
- 2 dozen whiting = 1 cwt.

LIME. 100 tons of blue lias lime yield 59.37 tons of quicklime: 1,583 bushels of ground lime, 2,063 bushels of slaked lime.

74 gallons of water are required for slaking 1 ton of quicklime.

- 1 ton of quicklime = 30 bushels.
- 1 " " " " = 27 bush. ground lime.
- 3 bush. ground lime = 1 sack.
- 9 sacks " " = 1 ton.
- 2 yards of lime = 1 ton.

21 bushels (striked), or 27 cub. ft. of lime or sand = 1 cub. yard.

- 3 bush. of lias lime = 1 sack.
- 9 sacks " " = 1 ton.
- 36 bushels " " = 1 load.

One cubic yard of lime, 2 yards of sand, and 3 bushels of hair, will cover 75 superficial yards, if rendered and set on brick, and 70 yards on lath, or 65 yards render float and set on brick, and 60 yards on lath. One cubic yard of coarse stuff equals 1 cart load.

LIME PLASTERING QUANTITIES.—Quantities of lime, sand, hair, and water required per superficial yard for various classes of plastering:—

Render only $\frac{3}{4}$ inch thick - - - -	$\left\{ \begin{array}{l} \text{Lime (unslaked),} \\ \text{Sand} \\ \text{Hair} \\ \text{Water} \end{array} \right.$	15 cub. ft.
		23 " "
		1 lb.
Render and set $\frac{1}{2}$ in. thick - - - -	$\left\{ \begin{array}{l} \text{Lime} \\ \text{Sand} \\ \text{Hair} \\ \text{Water} \end{array} \right.$	12 cub. ft.
		23 " "
		12 lbs.
Render and float $\frac{3}{4}$ in. thick - - - -	$\left\{ \begin{array}{l} \text{Lime} \\ \text{Sand} \\ \text{Hair} \\ \text{Water} \end{array} \right.$	25 cub. ft.
		38 " "
		17 lbs.
Render, float, and set $\frac{3}{4}$ in. thick - - - -	$\left\{ \begin{array}{l} \text{Lime} \\ \text{Sand} \\ \text{Hair} \\ \text{Water} \end{array} \right.$	32 cub. ft.
		38 " "
		18 lbs.
Setting with putty and plaster $\frac{1}{2}$ in. thick - - - -	$\left\{ \begin{array}{l} \text{Lime (unslaked),} \\ \text{Plaster} \\ \text{Water} \end{array} \right.$	10 cub. ft.
		3 " "
		100 gals.

For rough walls, the quantities should be slightly increased. The first coat on lath requires about one-tenth more coarse stuff than rendering.

The following is the method of calculating the above proportions to ascertain the amount of materials required for any given quantity of work to be executed. Multiply the quantities given in the above tables by the number of superficial yards of work required to be done. Example—What quantities of lime (unslaked), sand, hair, and water will be required to render 50 superficial yards and $\frac{3}{4}$ in. thick?

<i>Process.</i> —Lime	15	
	50	
	<hr/>	
	750	= 7 $\frac{1}{2}$ cubic feet.
Sand	23	
	50	
	<hr/>	
	1150	= 11 $\frac{1}{2}$ " "

Hair	-	-	1
			50
			500 = 5 lbs.
Water	-	-	1.2
			50
			6000 = 60 gallons.

And in a similar manner for other descriptions and quantities of work.

SELENITIC.—Three bushels of selenitic = 1 sack. 36 bushels = 1 ton.

REDUCTION IN BULK OF MATERIALS.—The reduction in bulk of dry cement when mixed with water is 10 per cent. of the total; of sand, 20 per cent.; and of sand and cement in equal proportions, 19 per cent.

POROSITY.—The relative porosity of limes and cements is as follows:—Common lime mortar (1 to 2), 100; plaster of Paris, 75; Roman cement, 25; and Portland cement, 10.

TABLE XVII.—QUANTITY OF MORTAR PRODUCED FROM ONE IMPERIAL BUSHEL OF VARIOUS LIMES AND CEMENT.

Description.	Lime or cement.		Sand, No. of Bushels.	Water, No. of Gallons.	Quantity of Mortar in cubic ft.
	Weight in lbs. per Bushel.	No. of Bushels.			
In Lump.	Stone lime (Plymouth)	70	1	3	12
	Lias (Keynsham)	80	1	3	9½
	„ (Lyme Regis)	70	1	2	8½
	„ „	70	1	3	8½
Ground.	Lias (Keynsham)	63	1	3	6½
	„ (Lyme Regis)	74	1	2	6
	Roman cement	72	1	...	6¼
	„ „	72	1	1	6½

* Six gallons of water are required to slake, and 6 gallons to mix each bushel.

† Two gallons are required to slake each bushel.

ROMAN CEMENT.—One cask of Roman cement holds 3¾ cubic ft., and the weight is about 3½ cwt. Three bushels of cement = 1 sack. One bushel of cement and 1 of sand will cover 4½ superficial yards ½ in. thick.

PORTLAND CEMENT.—Two centals (200 lbs.), London trade custom = 1 sack. Two bushels, Midland trade custom = 1 sack. One cask of Portland holds about 4 cubic ft. One cask varies from 375 to 400 lbs. gross, general London custom, for export.

TABLE XVIII.—SUPERFICIAL YARDS, RENDERED WITH PORTLAND CEMENT GAUGED WITH VARIOUS PROPORTIONS OF SAND, AND IN VARIOUS THICKNESSES.

	Proportions.		Thickness.				
			½ in.	¾ in.	1 in.	1¼ in.	1½ in.
1 bush. of cement, neat	2¾ yds.	2¾ yds.	2 yds.	1½ yds.	1 yd.		
1 „ „ and 1 of sand	4¾ „	3¾ „	3½ „	2¾ „	2¼ „		
1 bush. of cement and 2 of sand	6¾ „	5½ „	4¾ „	4 „	3½ „		
1 bush. of cement and 3 of sand	8½ „	7½ „	6¾ „	5¾ „	4¾ „		

NOTE.—¾ in. is the usual thickness.

TABLE XIX.—QUANTITY OF MATERIALS (IN VARIOUS GAUGES) REQUIRED TO MAKE ONE CUBIC YARD OF GAUGED PORTLAND CEMENT AND SAND.

1 and 1	{	Cement	-	-	12.62 bushels.
		Sand	-	-	12.62 „
		Water	-	-	30 gallons.
1 and 2	{	Cement	-	-	8.37 bushels.
		Sand	-	-	16.74 „
		Water	-	-	25 gallons.
1 and 3	{	Cement	-	-	6.37 bushels.
		Sand	-	-	19.11 „
		Water	-	-	23 gallons.

One cubic yard of gauged Portland cement and sand will render 70 superficial yards.

COMPARATIVE STRENGTH OF PORTLAND CEMENT AND SAND, IN VARIOUS PROPORTIONS.—At the end of one year after setting, 1 of Portland cement and 1 of sand is about three-fourths the strength of neat cement; 1 of cement and 2 of sand is about one-half the strength of neat cement; 1 of cement and 3 of sand is about one-third the strength of neat cement; 1 of cement and 4 of sand is about one-fourth the strength of neat cement; 1 of cement and 5 of sand is about one-sixth the strength of neat cement.

WEIGHT OF VARIOUS CEMENT CONCRETES HAVING VARIOUS AGGREGATES IN LBS. PER CUBIC FOOT.

The concrete consists of 1 part of cement to 3 of aggregate. As the weight of different kinds of the same class of aggregates varies, the average weights of the concrete are given:—

TABLE XX.—WEIGHTS OF VARIOUS CONCRETES.

	Lbs.
Pumice-stone concrete	70
Coke-breeze concrete	80
Brick concrete	120
Limestone concrete	130
Slag concrete	140
Gravel concrete	145
Granite concrete	145

TABLE XXI. WEIGHTS OF VARIOUS PLASTIC MATERIALS PER CUBIC FOOT IN LBS.

Ashes	118	Mortar, old	118
Clay, common	125	" new	110
" modelling	120	" well tem- pered	115
Cement, Portland	78	Plaster of Paris, cast	80
" Roman	60	Red pine wood	30
Chalk	125	Sand, dry	100
Gravel	112	" wet	130
Gypsum, natural	140	Shingle	95
Hair, ox, dry	11	Thames ballast	110
Lime, grey chalk, in lump	44	Wax	60
Limestone	53		

The weight of a superficial yard lath plaster, float and set ceilings of good quality, is about 98 lbs. If of interior quality, it would be about 8 lbs. less.

ROUGH-CASTING QUANTITIES.—For 100 yards superficial of rough-casting (two coat on lath) the following quantities are required: 25 cubic feet of lime, 50 cubic feet of sand, 16 lbs. of hair, and $\frac{3}{4}$ yard of prepared gravel for the dash coat. A quarter tub of lime putty should be mixed with every tub of gravel for the dash. To colour 100 yards superficial in any of the tints named herewith, the following quantities of ingredients are required: For a blue-black, 5 lbs. of lampblack; for buff, 5 lbs. of green copperas, to which add 1 lb. of fresh cow-manure, strained and mixed with the liquid dash. A fine terra-cotta colour is made by using 14 lbs. of red metallic oxide, mixed with 5 lbs. of green copperas and 4 lbs. of lampblack. The addition of 10 per cent. of alum solution to the liquid dash will give brilliancy and permanency to the colours. Various tints of these colours may be obtained by varying the quantities given.

CONCRETE QUANTITIES.—One sack of Portland cement (10 sacks to 1 ton), gauged in the ratio of 2 of cement to 5 of aggregate, will fill in 12 ft. run of moulded spandrel steps, 12-in. tread and 7-in. rise, or about 5 cubic feet.

Concrete paving slabs 2 in. thick weigh about 26 superficial lbs., or 9 superficial yards to 1 ton.

CONCRETE FOUNDATIONS.—It takes about 1 cubic yard of brickbats, stone, &c., to form 10 superficial yards of dry foundations 3 in. thick.

TERRA CONCRETE QUANTITIES.—One sack of Portland cement (10 to the ton) gauged with $2\frac{1}{2}$ sacks of aggregate will cover $4\frac{1}{2}$ superficial yards 2 in. thick. One ton of Portland cement, gauged with $2\frac{1}{2}$ parts (in bulk) of aggregate, will cover about 40 superficial yards 2 in. thick. The quantities vary according to the closeness and compactness of the dry foundation.

The quantities are slightly less for concrete foundations.

GRANITE CONCRETE PAVING QUANTITIES (Various Thicknesses).—One sack of Portland cement (10 to the ton) and 2 sacks of crushed granite will cover the following surfaces:—

TABLE XXII.

$12\frac{1}{2}$ super. yds. $\frac{1}{2}$ in. thick.	$3\frac{1}{2}$ super. yds. 2 in. thick.
$6\frac{1}{2}$ " " 1 in. "	2 " " $2\frac{1}{2}$ in. "
$4\frac{1}{2}$ " " $1\frac{1}{2}$ in. "	$2\frac{1}{4}$ " " 3 in. "

A sack of granite weighs nearly the same as a sack of Portland cement, so that when calculating by weight, the bulk of each can be reckoned about equal.

WEIGHT OF VARIOUS AGGREGATES.—The following materials weigh 1 ton, as filled into carts:—

21	cubic ft. of river sand.
22	" " pit sand.
22	" " Thames ballast.
23	" " coarse gravel.
24	" " clean shingle.

WATER AND HEAT MEMORANDA.—A medium-sized pail will hold 3 gallons of water. A pint of water weighs about 1 lb., and is equal to about 27 cubic in., or a square box 3 in. long, 3 in. wide, and 3 in. deep.

1 gallon of water equals	272·123 cub. ins.
1 " " (United States)	231·0 " "
$6\frac{1}{4}$ " " "	1 cubic ft.
1 cubic ft. of water weighs	4 lbs.

Salt water is heavier than fresh, and weighs 64·11 lbs. per cubic ft.

Water freezes at 32°, and boils at 212° Fahr.

The following table shows the relative heat conducting power of various materials:—

TABLE XXIII.

Silicate cotton or slag wool	-	100
Plaster of Paris	-	125
Sawdust	-	163
Coke-breeze	-	230

BUSHEL BOX.—A box 13 in. × 13 in. and $13\frac{1}{2}$ in. deep will hold 1 bushel of Portland cement. Another size, 12 in. × 12 in. and $15\frac{3}{4}$ in. deep. All inside measurements.

1 bushel contains	2218·192 cubic in.
1 " " (United States)	2150·42 " "

TIMBER.—Timber is now largely used by plasterers in the construction of fibrous plaster, and for concrete moulds and centring. A brief description of the terms and sizes may prove useful.

Timber is cut into various sizes, and the timber merchants use the terms "planks," "deals," "battens," "boards," "scantling," and "quartering." Planks are pieces of wood 11 in. wide, 2½ in. or 3 in. thick, and may be bought in lengths from 8 to 21 ft. Deals are 9 in. wide, 2½ in. or 3 in. thick, and of the same lengths as planks. Battens are 7 in. wide, 2½ in. thick, and likewise of the same lengths as planks. Boards are of less thickness than planks, deals, or battens, and are distinguished by their thickness, as "half-inch-board," "three-quarter-board," "inch-board," and so on; but they are often spoken of as so many "cuts," as "three-cut," "four-cut," "five-cut," &c., which means that the plank or deal, 3 in. thick, is divided by the number of saw cuts mentioned; thus, five cuts would divide the plank or deal into six boards, each being ½ in. thick, less the portion cut away as sawdust. Scantling simply means a quantity cut to any desired size for any purpose.

In a London deal standard there are 120 deals. 12 ft. × 9 in. × 3 in. = 1080 super. ft. = 270 cubic ft.

120 deals = 100.

100 super. ft. of planking = 1 square.

50 cubic ft. of squared timber
600 super. ft. of 1 in. planks or deals } 1 load.
400 " 1½ " " }

One square of centring requires 12 boards 12 ft. long and 9 in. wide.

An allowance of one-third to one-half is usually made for centring, &c., on reconverting to use.

Wood for special templates, squares, thin or circular strips, or laths for fibrous plaster work, is not so liable to crack or warp if steamed or boiled in hot water for three or four hours, and then slowly dried.

CHEMICAL NAMES OF COMMON SUBSTANCES USED BY PLASTERERS.

Common Name.	Chemical Name.
Lime	Oxide of calcium.
Slaked lime	Hydrate calcium.
Muriate of lime	Chloride of calcium.
Plaster of Paris	Sulphate of lime; also selenite.
Chalk	Carbonate of calcium.
Copperas or green vitriol	Sulphate of iron.
Blue vitriol	Sulphate of copper
White vitriol	Sulphate of zinc.
Oil of vitriol	Sulphuric acid.
Potash	Oxide of potassium.
Red lead	Oxide of lead.
Sugar of lead	Acetate of lead.
Iron rust	Oxide of iron.
Alum, dry	Sulphate of aluminium and potassium.
Common salt	Chloride of sodium.
Soda	Oxide of sodium.
Sand	Silica.

PLASTER AND CONCRETE COLOURS ON DRAWINGS.—Plaster work on architectural drawings is indicated by a grey colour; cement work by sepia or Payne's grey; and concrete by a blue colour.

VALUE OF PLASTER WORK.—In 1874, Major Seddon, R.E., made a series of experiments with a view to ascertain the amount of labour and material required for a given number of yards of plaster and cement work. The results are given in the subjoined table. The cost of scaffolding and carriage of materials are not included in the prices. The prices for labour and materials may be altered to suit local and present rates. These trials are valuable, inasmuch as it is certain that no vested interests were concerned, and that the experiments were made under proper conditions.

TABLE XXIV.—ANALYSIS AND COST OF MATERIALS AND LABOUR FOR PLASTER WORK.

Materials and Labour required for 10 sup. yards.	Render One Coat and Set.			Render Float and Set.		Lath Plaster and Set.		Lath Plaster, Float, and Set.		Portland Cement, Render Float and Trowel, 1 cement and 2 of sand.	
	Value.	Quantity	s. d.	Quantity	s. d.	Quantity	s. d.	Quantity	s. d.	Quantity	£ s. d.
Chalk lime, cub. ft.	0 4	5	1 8	6¼	2 1	5½	1 10	6¾	2 3
Sand	0 1½	5	0 7½	6¼	0 9¼	5½	0 8¼	6¾	0 10	6	...
Sand, washed "	0 3	6	0 1 6
Hair, dry, per lb.	0 3	2½	0 7½	3	0 9	2¾	0 8¼	3¼	0 9¾
Water, per gallon	...	20	0 1	25	0 1	22	0 1	27	0 1	15	0 0 1
Lath (lath and half) per bundle	2 0	2¼	4 6	2¼	4 6
Lath nails, per lb.	0 1½	4	0 6	4	0 6
Portland cement, per bushel	2 6	2½	0 6 3
Plasterer, per day	5 6	½	1 10	½	2 9	½	2 9	¾	4 1½	1¼	0 6 10½
Labourer, "	2 9	½	0 11	1½	1 4½	½	1 4½	¾	2 0½	1¼	0 3 5¼
Apprentice, "	1 6	½	0 6	1½	0 9	½	0 9	¾	1 1½
Cost, per 10 yards	6 3	...	8 6¾	...	13 2	...	16 3½	...	0 18 1¾
Cost, per yard	0 7½	...	0 10¼	...	1 3¼	...	1 7½	...	0 1 0¼

MEASURING PLASTERERS' WORK. — Plasterers' work when entered into the dimension book is generally treated with the following abbreviations: "F.P." stands for fibrous plaster; "R." for render; "R.S." for render and set; "L.P." for lath and plaster; "L.P.S." for lath, plaster, and set; "L.P.F.S." for lath, plaster, float, and set; "W.S.C.W." for wash stop (clair-olle), and whiten; "L.W." for lime white; "L.O." for labour only; "L.M." for labour and materials; "P.C." for prime cost; "dd." for deduct; "cub." for cubic; "super." for superficial; "yds." for yards; "ft." for feet; "in." for inches; a tick or dot also placed after a figure or figures is intended to describe feet, while two dots means inches, thus 3' 9" stands for 3 ft. 9 in.

Various forms of plaster work are measured by the yard and foot superficial, per foot lineal, and per inch girth. Per yard superficial includes render and set, trowelled stucco on brick lath, lath and plaster on walls and ceilings, fibrous slabs, and plain face, render float and set in cements for floors, walls, and ceilings, lime whitening, or colouring, washing, stopping, and distemping.

Per Foot Superficial. Cornices (over 6 in. girth), plaster and cement soffits, bands, margins, fascias, panels, dados, pilasters, columns, and large plain coves.

Per Foot Lineal.—Plaster or cement reveals, skirtings, narrow bands, and margins, arrises, beads, quirks, reveals and string courses, and enrichments.

Per Inch Girth. Mouldings 9 in. girth and under, and enrichments with circular profiles. Centre flowers, capitals, trusses, &c., are numbered; the cost of modelling is generally allowed for in the prices, but as the modelling is a distinct and important part of the work, the cost of same should be charged as a separate item, the design and nature of the labour, and the quality, being carefully described, and any speciality always mentioned.

Enrichments are numbered and charged separately according to schedule. Measure ceilings from wall to wall, and take out one projection of cornice. Measure walls from the top of skirting or wood grounds to half-way up the height of cornice for lath work, and one-third for brick work. Plaster work, if circular on plan, is measured one and a half times the girth by the height, and the area added to the plain work. If circular work is described and allowed for in the specifications, the girth is taken single. Panelled work is taken by the round of the panel, as square aris or moulding, and describing the girth of the moulding.

All enrichments to be taken distinct from the cornice, which is to be taken as plain, cornice being girthed in full.

All mitres over four in number to be charged each at the price of a foot run of moulding. Stops charged the same as mitres. Return mitres are charged as two.

Dubbing out with tiles or gauged stuff, in order to get an extra thickness or projection, or if the work is out of upright, is measured by the foot superficial, unless for narrow string course, when it is taken by the foot run. Internal and external work is always kept separate, and the various kinds of work, materials, and number of coats are always fully described.

Deduct all openings, with the exception of small oblong or circular windows, or ventilators, and columns, where the labour working round them is more than if the space had been done. Additions or joints with old work are measured 1 foot over the joints, to allow for the labour cutting and making good the joint. Patches are not measured, but charged time and materials.

For small triangular parts and closets, where shelves are in, it is customary to add one half of the measurement to the measurement, to allow for extra labour of plastering such work.

Cement floors are measured by the superficial yard, describing the proportions of sand (or other aggregate) and cement, but small works, such as hearths, cisterns, &c., are taken by the superficial foot.

SQUARING DIMENSIONS.—Lineal measure relates to length only. Superficial measure to length and breadth. Cube, or solid measure, to length, breadth, and thickness. If feet are multiplied by feet, the product will be feet. If inches are multiplied into feet, every 12 of the product will be feet. If inches are multiplied into inches, every 12 of the product may be reckoned as an inch, and any number less than 12 as parts of an inch. If parts of an inch are multiplied by feet, every 12 of the product will be 1 inch, and any number less than 12 will be parts of an inch. If parts of an inch are multiplied by inches, every 12 of the product is 1 part, and any number less than 12 are seconds.

There are various methods of squaring dimensions. The following are generally used. The primary object in all cases is to find the contained number of square or superficial feet and parts of feet, and having found the number, divide by 9, which gives the number of superficial yards. The dimensions of length and breadth expressed in feet and inches are multiplied together by duodecimals, and the result is the number of "superficial" feet and parts of a foot.

The first method is usually known as cross-multipli-

cation, and will be explained by the following example. Find the contents superficial of a wall 11 ft. 4 in. long and 7 ft. 5 in. high. The process is as follows: Set down the figures with a cross between them, thus—

$$\begin{array}{r}
 \text{Ft. In.} \\
 11 \times 7 \\
 \hline
 7 \times 5 \\
 \hline
 \text{Ft. In.} \\
 11 \times 7 = 77 \text{ } \circ \\
 5 \times 11 = 4 \text{ } 7 \\
 4 \times 7 = 2 \text{ } 4 \\
 5 \times 4 = 0 \text{ } 1 \text{ } 8 \text{ pts.} \\
 \hline
 \end{array}$$

Total contents . . . 84 0 8 pts.

The following simple method of calculating for multiplying ft., in., and parts, and which holds good either in cubic or square measurements, is to remember ft. \times ft. give ft.; ft. \times in. give in.; in. \times in. give in.; in. \times pts. give pts.; pts. \times pts. give thirds., &c.

Example.—11 ft. 4 in. \times 7 ft. 5 in. are multiplied thus—

$$\begin{array}{r}
 \text{Ft. In. Pts.} \\
 11 \text{ } 4 \\
 7 \text{ } 5 \\
 \hline
 4 \text{ } 8 \text{ } 8 \\
 79 \text{ } 4 \\
 \hline
 84 \text{ } 0 \text{ } 8 \text{ } \textit{Ans.}
 \end{array}$$

Another method may be shown by example:—Find the contents (superficial) of a wall 14 ft. 7 in. long and 9 ft. 2½ in. high.

Process.—Set the figures down thus—

$$\begin{array}{r}
 \text{Ft. In. Ft. In.} \\
 14 \text{ } 7 \times 9 \text{ } 2\frac{1}{2} \\
 \text{Ft. In. Pts.} \\
 14 \text{ } 7 \\
 9 \text{ } 2 \text{ } 6 \\
 \hline
 7 \text{ } 3 \text{ } 6 \\
 2 \text{ } 5 \text{ } 2 \\
 131 \text{ } 3 \text{ } 0 \\
 \hline
 140 \text{ } 11 \text{ } 8 \text{ } \textit{Ans.}
 \end{array}$$

A quick way. Find the superficial contents of a ceiling 20 ft. long and 18 ft. wide.

Process.—180 \times 2 = 360 superficial ft.

Find the contents (superficial ft.) of a margin 21 ft. long and 18 ft. wide.

Process.—As 18 in. equals 1½ ft.; thus 21 \times 1½ = 31½ superficial ft.; or 31 ft. 6 in. superficial.

To find the superficial contents of a cylinder or column. Multiply the diameter by the length, and the product by 355, and divide the last product by

113; the quotient is the superficial contents. Another way is to multiply the circumference by the length; the product is the superficial contents.

Another way still is that the superficial contents are found by multiplying half the diameter by itself, and the product by 3½; or in other words, multiply the square of the radius by 22, dividing by 7; the product is the superficial contents of the whole circle. If it is only half a circle, multiply by 11 instead of 22.

TO MEASURE TRIANGLES.—Triangular pieces of work are measured by taking the length of one of the sides by half of its perpendicular distance from the opposite vertex (point of angle); these dimensions, when multiplied together or squared, will give the superficies of the triangle. Other irregular figures are measured in the same way, by dividing them into triangles.

TO MEASURE IRREGULAR WIDTHS.—If a wall or other surface is wider at one end than the other, add the width of both ends together; half the sum is the mean width, then multiply the mean width by the length.

Cube or solid measure is not much required in ordinary plasterers' work, but as artificial stone work is coming largely into use, and being done by plasterers, the following examples are given.

The dimensions of length, breadth, and depth, expressed in feet and inches, are all multiplied together by the usual method as employed in superficial, and the result is obtained in cubic feet, 12ths, and 144ths. Thus to find the contents of a pilaster, 11 ft. 3 in. long, 1 ft. 2 in. broad, and 11½ ft. deep.

Process.—First multiply 11 ft. 3 in. by 1 ft. 2 in., which gives superficial feet, 12ths, &c., and multiply that result by 11½ in., which gives cubic ft., 12ths, &c.

$$\begin{array}{r}
 \text{Ft. In. Ft. In. In.} \\
 11 \text{ } 3 \times 1 \text{ } 2 \times 11\frac{1}{2}
 \end{array}$$

Thus—

$$\begin{array}{r}
 \text{Ft. In.} \\
 11 \text{ } 3 \\
 1 \text{ } 2 \\
 \hline
 1 \text{ } 10 \text{ } 6 \\
 11 \text{ } 3 \text{ } 0 \\
 \hline
 \end{array}$$

$$\begin{array}{r}
 \text{Multiplied by} \\
 13 \text{ } 1 \text{ } 6 \text{ superficial ft.} \\
 11 \text{ } 6 \\
 \hline
 6 \text{ } 6 \text{ } 9 \\
 12 \text{ } 0 \text{ } 4 \text{ } 6 \\
 \hline
 12 \text{ } 6 \text{ } 11 \text{ } 3 \text{ cubic or solid ft.}
 \end{array}$$

The 12th of a cube foot must not be confounded with the cubic inch, as it really contains 144 cubic inches.

A quick way for the same operation is to find the

contents (cubic) of 6 caps, each 1 ft. by 1 ft. 2 in. by $1\frac{3}{4}$ ft.

Multiply together the length, breadth, and depth of one cap in feet, and the largest fractions of a foot, and multiply by the given number of caps, thus

$$\frac{1 \times 7 \times 7 \times 6}{6 \times 4} = 12\frac{1}{4} \text{ cubic ft.}$$

An old way to find the contents (cubic) of a window head 6 ft. long, 10 in. wide, and 7 in. deep.

Multiply the length by breadth, and the product by the depth. Multiply this product by 12, and divide by 1728. The result is 2 cubic feet and $\frac{1584}{1728}$.

Thus —

$$\begin{array}{r} 6 \text{ ft.} \\ 10 \text{ in.} \\ \hline 60 \\ 7 \text{ in.} \\ \hline 420 \\ 12 \text{ in.} \\ \hline 840 \\ 420 \\ \hline \end{array}$$

The inches in a solid foot 1728)5040(2 ft.

The inches in a quarter foot 432)1584(3 quarters 288 in.
288

A short way is performed thus —

$$\begin{array}{r} 11 \text{ } 10 \text{ } 10 \\ 6 \times 10 \times 7 \\ 11 \text{ } 10 \\ 6 \text{ } 0 \\ 10 \\ \hline 5 \text{ } 0 \\ 7 \\ \hline 2 \text{ } 11 \end{array}$$

A method of calculation for showing the contents of a cubic foot in cubic inches is: Find the contents of a concrete block 12 in. by 12 in. by 12 in. Multiply the length by the breadth, which gives the superficial contents. This multiplied by the depth gives the cubic contents. Thus

$$\begin{array}{r} 12 \text{ in.} \\ 12 \\ \hline 144 \text{ super. contents.} \\ 12 \\ \hline 1728 \text{ cubic in. or 1 cubic ft.} \end{array}$$

The diameter of a circle being given, find the circumference. As 7 is to 22, or as 113 to 355, so is the diameter to the circumference.

Example. Find the circumference of a circular panel moulding, the diameter of which is 12 feet.

Process. Multiply the diameter by 355, and divide the product by 113. Thus —

$$\begin{array}{r} 355 \\ 12 \\ \hline 113)4260(37 \text{ ft. } \frac{79}{113} \text{ of a foot.} \\ 339 \\ \hline 870 \\ 791 \\ \hline 79 \\ \hline 113 \end{array}$$

The circumference being given, the diameter is found by dividing the circumference by $3\frac{1}{2}$.

Example. Find the diameter of circular panel moulding, the circumference of which is 11 feet. Thus

$$\frac{11 \times 7}{1 \text{ } 12} = 3\frac{1}{2} \text{ ft.}$$

Another way is — Multiply the circumference by 113, and divide the product by 355.

To find the area of an ellipse, multiply the long diameter by the short diameter, and by the decimal .7854, and the product will give the area.

To find the cubic contents of a true tapered pyramid, whether round, square, or triangular. Multiply the area of the base by $\frac{1}{3}$ the height.

To find the cubic contents of a cylinder. Multiply the square of the radius by the thickness, both in feet and fractions of a foot, and the product by $3\frac{1}{2}$.

Another way is to multiply the square of the diameter by the thickness, both in inches, and divide by 2200, and the product is in cubic feet.

Another way: Multiply the square of the diameter by 7854, and the product by the length.

A cylindrical foot is the solid contents of a cylinder, 1 foot in depth and diameter, and is equal to 1728 cylindrical inches. Cylindrical inches + 7854 = cubic inches.

To find the superficial contents of a circle. Multiply the half diameter by itself, and the product by $3\frac{1}{2}$, or in other words, multiply the square of the radius by 22, and divide the product by 7. This gives the superficial of the whole circle. If it is only a half circle, multiply by 11 instead of 22.

Example. Find the contents of a circle, the diameter of which is 12 feet.

Process.—First square the half diameter, or radius. Thus—

$$\begin{array}{r}
 6 \\
 6 \\
 \hline
 36 \\
 22 \\
 \hline
 7^2 \\
 7^2 \\
 \hline
 7792(113\frac{1}{2}).
 \end{array}$$

Another way is to supply the square of the diameter by the decimal .7854; or multiply the circumference by the radius, and divide the product by 2.

And yet another way: The diameter being given, multiply the square of the radius by 3 $\frac{1}{2}$.

Example.—Find the area of a circle panel, the diameter of which is 36 inches. Thus—

$$\frac{3 \times 3 \times 22}{2 \times 2 \times 7} = 7.07 \text{ ft.}$$

II.—RECIPES FOR PLASTER WORK.

TO HARDEN PLASTER CASTS.—Numerous patents have been obtained and many methods used for hardening plaster casts. The following are some of the most simple and effective methods. In order to obtain the maximum of hardness, the plaster should be gauged as firm and as quick as is possible. When plaster is hardened by soaking or coating with a solution, the work should be perfectly dry, and also warm, so that the solution may penetrate more easily. Where practical, the casts should be immersed in the solution. The work of hardening and polishing should be done in a clean, dry, and warm room, free from draughts of cold, or damp air, or dust.

The addition of about 5 per cent. of good corn-flour to plaster renders it hard and tough. This admixture is useful for casting plaques and similar ornaments. Ground rice is used for a similar purpose.

Plaster casts can be made extremely hard and tough by adding pulverised marsh-mallow root to the plaster, also by gauging the plaster with the water in which marsh-mallows have been boiled. If the plaster is gauged with 4 per cent. of finely pulverised marsh-mallow, the setting is retarded for about one hour. When dry, it may be filed, sawn, or turned. With 8 per cent. of marsh-mallow the setting is further retarded, but the toughness and hardness is increased. This may be rolled out on glass in thin plates. It may be used as a substitute for carton-pierre, also for the manufacture of enrichment or mouldings that have to stand rough usage, also for frames, brackets, panels, &c. This material will take a good polish. Plaster casts may be rendered hard by soaking in or brushing with a hot solution of strong alum. Plaster casts formed with marsh-mallow, as above, and soaked in a hot solution of alum, renders the casts as hard as stone and as tough as wood, and capable of receiving a polish equal to marble. A sharp blow

will cause an indentation rather than shatter it. It forms a good surface for paint or gilt. Plaster casts are rendered hard by soaking in or brushing with a hot solution of stearic acid and soda lye. Plaster casts are hardened by soaking in a hot solution of stearine. The casts by this method may be polished by rubbing with soft rags or cotton wool, also with a soft brush. Plaster casts may be rendered hard and impervious to damp by soaking them in a hot solution of paraffin wax. They may also be rendered hard and tough by soaking in linseed oil for ten hours, then air drying and soaking again for six hours. Warm glue size is also used for a similar purpose, and also by soaking the casts in strong solution of potash alum. Soaking in sulphate of zinc is also useful for this purpose. The immersion should not exceed two hours; if immersed longer the plaster will become friable. Plaster immersed in a strong solution of borax, gradually heating it, becomes nearly as hard as marble, and may be polished in like manner. Plaster casts immersed in paraffin oil become hard, and assume a fine surface.

Plaster and Portland cement (cast or laid) work may be rendered hard and tough by gauging the material with from 10 to 15 per cent. of minion. Minion is the siftings of ironstone after calcination. Signor Abati, of Naples, found that by combining plaster with the minimum quantity of water, by the application of steam, filled into moulds and submitted to hydraulic pressure, the cast became as hard as marble and as susceptible to polish.

NEW MODE OF HARDENING PLASTER.—Mr Julhe, in a note presented to the Academie des Sciences, describes some experiments that he has performed with a view to rendering the use of plaster still more general. Of all materials used in building, plaster is

the only one which increases in bulk after its application, while mortars and cements, and even wood, undergo shrinkage and cracking through drying. When applied in sufficiently thick coats to resist breakage, it offers, then, a surface that time and atmospheric variations will not change, provided it be protected against water. But it is necessary to give this material two properties that it lacks—hardness and resistance to crushing. This is what Mr. Julhe proposes to effect by his process. Six parts of plaster are mixed with one of finely sifted unslaked lime. This mixture is used like ordinary plaster for moulding any object whatever, and, when once dry, the object is soaked in a solution of a sulphate having a base precipitable by lime, and the precipitate of which is insoluble. These form sulphate and oxide of lime, both of them insoluble, which fill the pores of the object and render it hard and tough. Sulphates of zinc and iron are the salts that answer the purpose best. With the first the object remains white, and with the second it gradually assumes the tint of sesqui-oxide of iron.

POLISHING PLASTER CASTS. Plaster casts can be made to take a high polish. Those which are to be polished by friction with other substances should be made as hard as possible. The plaster should be gauged firm, and used expeditiously. When a soft-gauged plaster is necessary to allow it to be run into closed up moulds, the cast may be partly hardened by dusting the back with dry plaster to absorb the moisture. Gauging with alum water hardens plaster, but causes it to set too quick for manipulation in certain kinds of moulds. This may be overcome by adding size water (which also hardens plaster) to the gauging water. The setting may be regulated to any required degree. Casts intended to be polished should be covered with paper or cloths until dry, and kept in a dry and warm place.

The following are the best known methods for polishing plaster casts: To 4 lbs. of clean water add 1 oz. of pure curd soap, chipped and dissolved in a glazed pot; next add 1½ oz. pure white beeswax cut into thin slices. When it is all properly mixed, it is fit for use. The figure must be dried, and suspended by a string. It is then dipped into the liquid varnish, and when taken out, allowed to stand for about three minutes; stir up the varnish, and then dip the figure again. Cover it up in a dry place, free from all dust, for six or seven days, after which take some soft rag or cotton wool, and gently rub the figure until it has received a brilliant gloss.

Another way. Plaster casts soaked in olive oil in which white wax has been dissolved by heat, or casts

soaked in dissolved paraffin wax, will, when dry, take a fine polish. The casts should be hot when put into the hot solution. The polishing is done with French chalk and cotton wool. If the polished casts are left in a smoky room, they will acquire the appearance of old ivory. Plaster casts can be made to assume any colour by dissolving in the water for gauging any desired colour in powder.

Another way. Soak the casts in a hot solution of white beeswax and glycerine. When dry, polish with French chalk and cotton wool or sable hair brushes.

Another way. Take clean skimmed milk, and with a clean soft brush coat the figure until it will absorb no more. Gently blow off all superfluous milk from the face of the object, and lay it in a place perfectly free from dust. When dry, it will have the appearance of polished marble. A great deal depends on the amount of care bestowed on the skimming of the milk. Plaster gauged with milk and water will enable the casts to be polished.

Another way.—Plaster casts thoroughly dry and brushed with two coats of clear linseed oil, and kept for a while in a smoky room, will take a good polish, and acquire the appearance of old ivory.

Another way.—Dissolve ½ oz. of soft soap in 1 quart of water, and then incorporate 1 oz. of white wax. The cast is dipped in or brushed over with this mixture. When dry, it may be polished with soft rag and French chalk. Another way is to give the cast a thin coating of white shellac, then paint over this a good coating of boiled soft soap, and polish when dry with a soft dry rag.

Another way. A beautiful varnish for plaster casts may be made by fusing ½ oz. of tin and ½ oz. of bismuth in a crucible. Melt together, then add ½ oz. of mercury. When perfectly combined, take the mixture, allow it to cool, and add the white of an egg. The casts must be dry, and free from stains or dust.

Another way.—The cast must be perfectly dry, and free from scratches and dust. Give it a coat of linseed oil, and allow it to stand until dry, after which give another coat, and French polish in the ordinary way. If a figure or bust is required to be white, make smooth with white size, and varnish with hard white varnish.

Another way.—Take 2 parts stearine, 2 parts Venetian soap, and 1 part pearl-ash. Grate the stearine and soap, and mix with 30 parts of solution of caustic potash. Boil this for thirty minutes, stirring all the time. Add the pearl-ash dissolved in a little clean rain water, and boil for five minutes. Stir until

cold, and mix with more ley until it is quite liquid. Before use, it should be allowed to stand for a few days, keeping it properly covered up. Let the figure be clean and well dried. Coat with a soft brush or sponge until the figure will absorb no more. Allow it to stand well covered up, and give another coat. When dry, rub with soft rags or a brush. This will give a beautiful polish. The liquid may be kept for years if properly covered up. Should the surface not have the required degree of gloss, the operation must be repeated. This liquid has the property of hardening the plaster.

Another way.—Take a clean cast, well dried, and coat with white wax. Place it before a fire until the wax is absorbed. A good polish may then be obtained by friction.

Another way.—Plaster may be polished with French chalk until it shines like glass. The cast when nearly dry is dusted with the finest French chalk, and gently rubbed with cotton wool. Repeat the dusting and rubbing until a bright polish is obtained, taking care that the chalk does not cake and injure the face of the cast. When perfectly dry, it may be dusted and rubbed again to give a good finish. For deep parts in a cast, where it is difficult to use the wool, use a camel hair brush. French chalk can be used as a help in the final polish in most of the other methods described.

WASHABLE PLASTER CASTS.—In 1878, F. von Dechend, of Bonn, obtained a patent for “making plaster casts washable without injury.” The process consists of two distinct operations. One consists in the application of a solution of borax and alum to harden the plaster, and the finishing operation consists in the application of insoluble precipitates, by which the minutest pores are filled up and the surface rendered hard. Salts of barium, calcium, and strontium are suitable for obtaining insoluble precipitates without forming spots. A method of performing the process may be done as follows:—A hot saturated solution of borax is spread with a brush over the cast any required number of times; next hydrochlorate of barytes, likewise in the form of a hot solution, is laid on with a brush, then soap solution is likewise applied hot, any excess being removed with hot water.

IMPERVIOUS PLASTER CASTS.—A mixture of 2 parts of fine plaster and 1 part of fluor spar powder is gauged for the cast. When dry, it is rendered impervious by coating with soluble glass.

METHODS OF PREPARING PLASTER CASTS TO RESIST THE ACTION OF THE WEATHER.—BRETHAUER’S method is to slake 1 part of finely pulverised lime to

a paste, then mix gypsum with lime-water, and intimately mix both. From the compound thus prepared the figures are cast. When perfectly dry, they are painted with hot linseed oil, repeating the operation several times, then with linseed-oil varnish, and finally with white oil-paint. Statues, &c., prepared in this way have been constantly exposed to the action of the weather for four years without suffering any change.

JACOBSEN prepares casts which retain no dust, and can be washed with lukewarm soap-water, by immersing them or throwing upon them in a fine spray a hot solution of a soap prepared from stearic acid and soda lye in ten times its quantity, by weight, of hot water.

SHELLHASS recommends the coating of plaster of Paris casts with a compound of finely powdered mica and collodion prepared as follows:—The mica, rendered perfectly white by boiling with hydrochloric acid or calcining, is ground very fine, sifted and elutriated, and then mixed with dilute collodion to the consistency of oil-paint, and applied with a soft brush. Casts coated in this way possess a silvery lustre, have the advantage of being indifferent to sulphurous exhalations, and can be washed without injury.

PLASTER FOR CASTING METAL.—Plaster mixed and gauged with equal parts of powdered pumice-stone makes a heat-resisting mould for casting fusible metals.

TO RESTORE PLASTER. Plaster that has lost its hard and quick-setting properties by dampness or exposure to air may be partly restored and used for gauging coarse stuff by boiling in an iron pot or pail, keeping the plaster continually stirred with a stick or iron rod.

TO WATERPROOF PLASTER WORK. A solution for protecting plaster exposed to the weather is composed of 6 parts of linseed oil, boiled with one-sixth of its weight of litharge, and adding 1 part wax. The plaster surface must be clean and dry before the solution is applied. It is laid on hot with a brush. A warm dry day should be selected for using the solution.

PLASTER TO SET QUICK.—Plaster may be made to set rapidly by adding alum. The alum should be previously dissolved in water, and the alum solution added to the pure water when gauging. Alum water also increases the ultimate hardness of plaster. White vitriol, dextrine, chloride of sodium (common salt), sulphate of potassium, or gauging with warm water, will quicken the setting.

PLASTER TO SET SLOW.—The setting of plaster

may be retarded by adding or gauging with size water, ammonia, or stale beer. Sulphate of zinc added to the water has also a marked effect in retarding the setting and increasing the ultimate hardness of plaster.

TO CLEAN ANTIQUE PLASTER CASTS.—Old casts that require to be carefully preserved and cleaned can be restored by coating with a thin paste made of starch. When partly dry, peel it off.

TO CLEAN PLASTER FIGURES, BUSTS, &c. Plaster hollow casts soiled by dirt or dust may be in most instances restored to their original whiteness. The cast is inverted, and filled with clean water, free from iron, and allowed to stand until the water has filtered through the cast. The outside is occasionally washed with water by the aid of a soft brush or sponge.

TO CLEAN KEEL'S CEMENT. One oz. carbonate of potash, 1 oz. carbonate of soda, $\frac{1}{2}$ oz. Venus turpentine, 1 pint of warm water—all dissolved together. Coat the object with the above solution, then with a plaster padded flannel dipped in dissolved stearine rub the object. This method may also be used to clean plaster.

SEMI-TRANSPARENT CASTS.—Beautiful casts for plaques are made by gauging fine ground rice with fine plaster in the proportion of one of plaster to three of rice. Neat rice can be used for a thin coat on the face, if gauged stiff, well pressed into the mould, and allowed to dry. A backing of the rice and plaster will give further strength.

JAPANESE CASTS. Beautiful transparent casts can be obtained by using fine ground rice in place of plaster. The moulds must be quite clean, and the cast allowed to set before it is extracted. The rice flour must be mixed intimately with cold water, then gently boiled, and then poured into the moulds while warm. A solution of rice, prepared this way, makes an excellent paste. Papers pasted together by means of this solution will sooner separate in their own substance than at the joining.

MODELLING COMPOSITION. Mix 200 parts of soapstone powder and 100 parts of the best wheat flour, and stir the mixture carefully into 300 parts of melted white wax, not too hot. This mass can be coloured at pleasure.

AMERICAN MODELLING WAX. Melt carefully over a moderate fire 2 lbs. of yellow beeswax, add $4\frac{1}{2}$ oz. of Venetian turpentine, 2 oz. of lard, and $2\frac{3}{4}$ lbs. of bole, and mix thoroughly. Then gradually pour the mixture into a vessel with water, and thoroughly knead several times with the hands. The wax should be melted at such a low temperature that no bubbles appear on the melted surface.

AMERICAN PASTE COMPOSITION.—Mix together 13 parts of dissolved glue, 14 parts pulverised litharge, 8 parts white lead, 1 part plaster, and 10 parts of very fine sawdust. This composition is extensively used in the manufacture of picture frames, and as a substitute for carton-pierre, &c.

STATUARY MARBLE CASTS. Figures, busts, or other plaster casts or walls can be made to imitate statuary marble true to nature. First gauge superfine plaster with ground marble and white alabaster, and to give greater lustre a small portion of finely ground white glass is added. White mica may also be used for this purpose. The quantities depend on the tint of the marble required. The general proportions are 2 parts of plaster, 1 of marble (or marble and alabaster in equal proportions), and $\frac{1}{2}$ part of glass. The moulds are oiled with olive oil or paraffin oil and French chalk. The materials are gauged middling stiff, using a little clear size water in the gauging water. This gauge is laid about $\frac{1}{4}$ inch thick, and then backed up with neat gauged plaster. The casts can be polished with Tripoli powder, French chalk, or by some of the methods already given.

WHITE MARBLE CASTS.—To produce plaster medallions, busts, &c., with a white marble-like appearance, mix from one-third to one-half part of finely pulverised plate glass with one part of superfine plaster. This mixture is gauged and poured into the mould in the usual way. The mould must be thoroughly clean, and oiled with salad oil or paraffin. The casts, when nearly dry, may be polished by dusting with fine French chalk, and then rubbing lightly and quickly with cotton wool. If the moulds are open so as to admit of the stuff being pressed, a harder surface may be obtained by substituting superfine Parian or Keen's for the plaster. The casts may also be polished by some of the other methods given.

MARBLINE MEDALLIONS.—To make a plaster medallion look like marble, boil pure sweet milk, and then skim it two or three times, pour it on the face of the cast, and blow it evenly on all parts, taking care that it does not get on the back; lay it aside, and cover it with clean white paper to protect it from dust for two or three days, then put it in a shallow dish face up, and pour in oil of sweet almonds until it comes up to half or two-thirds of the edge of the cast. Be careful that none gets on the face. As the cast absorbs the oil, pour in more until it is saturated. This makes the plaster perfectly transparent, and of a beautiful colour. The milk forms a fine coat on the surface which will bear washing.

PLASTER IMITATION OLD IVORY.—Ivory carving

may be so closely imitated that only an expert can detect the difference. Ivory carvings, or rather castings, when mounted in metal, wood, or plush frames, have been sold in great numbers, and at highly remunerative prices, at exhibitions and art dealers' sales. The process is simple, but requires a considerable amount of skill on the part of the craftsman. The moulds are generally taken from real ivory, carving wood, or art metal work. Superfine plaster is used. The water is tinted with fine yellow ochre. For the general colour of old ivory, add $\frac{1}{2}$ oz. to each pound of plaster. When the casts are thoroughly dry, they are dipped into spermaceti, and suspended until the excess of the spermaceti has run off, and when the cast is nearly dry, but still sticky, fine yellow ochre is sprinkled on. The prominent parts are wiped with fine rags or cotton wool. The success of the work greatly depends on the art displayed in laying and wiping the ochre. The ochre is dusted through a fine muslin bag. Sometimes the grain or spots (as seen in old ivory) is obtained by brushing, stippling, or dabbing with small tool brushes having the hair cut square, short, and wide apart. If the cast is too large to be dipped, it can be brushed over with warm spermaceti quickly and evenly, taking care that the spermaceti does not cake. In both methods the casts should be warm, and the ochre ground to a fine powder. To imitate new ivory, gauge with the tinted water, and when the cast is dry, dip it for fifteen minutes into a solution of spermaceti, white wax, and stearine in equal parts, then polish with cotton wool.

FICTILE IVORY (*French process*).—The cast is made by gauging the plaster in the proportion of 1 lb. of superfine plaster and $\frac{1}{2}$ oz. of the finest yellow ochre. They are thoroughly mixed by passing them through a fine sieve, and then gauged with clean cold water, to which a few drops of the best glue water have been added. The cast is first allowed to dry in the air, then carefully heated in an oven, and when the cast is thoroughly dry, and still warm, it is soaked for a quarter of an hour in a bath containing equal parts of white wax, spermaceti, and stearine, heated a little beyond the melting point. The cast is set on edge to allow the superfluous wax mixture to drain off, and before it is cool the surface is brushed with a soft tool brush to remove any wax that may have settled in the crevices. When the cast is cold, it is finally finished by polishing with cotton wool.

TO TAKE PLASTER CASTS OF NATURAL OBJECTS.—By this process, plaster casts of the most delicate objects of natural history can be reproduced. The material of the mould is modelling wax. As it becomes

soft and plastic by the application of heat, though in a cold state it is perfectly rigid, it takes the most minute markings and striations of the original to which it may be applied without injuring it, and the microscopic structure of the surface of the original is carefully reproduced in the cast. This method is briefly this: Cover the object to be cast with a thin powder of steatite or French chalk, which prevents the adhesion of the wax. After the wax has become soft, either from immersion in warm water or from exposure to the direct heat of the fire, apply it to the original, being careful to press it into the little cavities. Then carefully cut off the edges of the wax all round, if the undercutting of the object necessitates the mould being in two or more pieces, and let the wax cool with the object in it until it is sufficiently hard to bear the repetition of the operation on the uncovered portion of the object. The steatite prevents the one piece of the mould sticking to the other. The original ought to be taken out of the mould before the latter becomes perfectly cold and rigid, as in that case it is very difficult to extract. Then pour in plaster, after having wetted the moulds to prevent bubbles of air lurking in the small interstices; and if the mould be in two pieces, it is generally convenient to fill them with plaster separately before putting them together. Then dry the plaster casts, either wholly or partially. Paint the casts in water colours, which must be fainter than those of the original, because the next process adds to their intensity. The delicate shades of colour in the original will be marked in the cast by the different quantity of the same colour, which is taken up by the different textures of the cast. After drying the cast, steep it in hard paraffin. Cool and polish the cast by hand and cotton wool with steatite.

WHITE CEMENT.—The German Government some years ago offered valuable money prizes for a substitute for plaster, or for a method of rendering plaster weather-proof without destroying the original whiteness. A great many inventors and chemists tried, but none attained the desired result. It is now said that an artificial white cement is manufactured in Germany that has all the properties of Portland cement. It is made by grinding 3 parts of fine chalk and 1 part of kaolin, burning them at a red heat, and then re-grinding. There certainly would be a large demand for a strong white cement that could be used for external plastering and for making artificial stone, and while having all the properties of Portland cement, would have a more pleasing colour. The native carbonate of magnesia, magnesite, if originally of a light colour, can be calcined at a low heat into a white cement which is said to be stronger than

Portland cement; but magnesite is a rare mineral, consequently the price of cement made from it would be prohibitory.

WEATHERPROOFING PLASTER CASTS.—Another result of the prizes offered by the German Government are the two following experiments made by Dr W. Reissig, of Darmstadt, in his endeavour to render plaster casts washable, and at the same time to preserve the sharpness of outline.

He found this could be effected (1) by converting the lime sulphate into baryta sulphate and caustic or carbonate of lime, or (2) by changing the lime sulphate into lime silicate by means of potash silicate. Of the two methods, the former is preferable, being simpler, more economical, and more easily carried out. The lime sulphate is changed into baryta sulphate and caustic lime by means of baryta water. Exposure in the air subsequently changes the caustic lime into lime carbonate. This is best worked by using a zinc vessel with a zinc grating $1\frac{1}{2}$ in. from the bottom, and a close-fitting lid, which must be nearly three parts filled with soft water, 54 to 77 Fahrenheit. To every 25 gallons of water add 8 lbs. fusel oil or 14 lbs. crystallised pure hydrated barium oxide, and 0.6 lb. lime which has been slaked in water. The solution stands about 4 Beck (1.0241 sp. gr.). When the baryta water is clear, the casts may be immersed, being previously suspended by cords. The dipping should be effected with rapidity. Hollow casts after being saturated are filled with the solution and suspended in the bath, and the vessel is closed from two to twelve days, according to the silicate stratum required. Then remove the cover and the scum, draw the casts out by means of the cords, rinse with lime water, drain and wipe with soft rags. Do not handle them, and leave them to dry in a warm place. The solution can be used again by adding more baryta and lime.

2. To harden by means of the silicate of potash solution, convert the lime sulphate into lime silicate by using a diluted solution of potash silicate containing free potash. Make a 10 per cent. solution of caustic potash in water, heat to boiling point, adding pure silicic acid (free from iron) as long as it continues to dissolve. After cooling the solution deposits silicated potash and alumina. Leave it in well-stoppered glass bottles to settle. Before using, throw in some pieces of pure potash, or add about 2 per cent. of the potash solution. To indurate the casts, dip them when cold for a few minutes into the solution, or apply it by means of a sponge. When the chemical reaction is finished, remove the excess of the solution by means of soap and water, and subsequently rinse with warm pure water. When thoroughly dry,

the plaster casts can be washed with cold soap and water, with the addition of oil of turpentine, taking care that the sponge used be thoroughly clean. Then rinse with clean water.

GLYCERINE COMPOSITION.—This is a mixture of litharge and glycerine. Several other metallic oxides may be mixed with the cement. The proportions vary according to the consistency required, the proportion of glycerine being greater for a soft cement. It sets quickly, attains great hardness, and does not shrink. It is used in Paris for producing blocks and plates for printing and photoglyphic purposes. It is especially adapted for moulding where extreme delicacy of lines is required. Many other applications of this compound are extremely useful. As a cement for joining chemical apparatus it offers many advantages, for it is unaffected by chlorine, hydrochloric acid, sulphur vapour, sulphurous acid, nitric acid, and indeed resists most corrosive vapours. Further than this, it withstands the solvent action of alcohol, ether, sulphide of carbon, and all hydrocarbon vapours. It hardens in from ten to twenty minutes if mixed of the consistence of a thick dough, and sets under water as quickly as in air. Moreover, it will stand a very much higher temperature than any oil cement. The composition may be also employed for moulds for electrotyping and for casting metal work. For this purpose glycerine must be stirred with the litharge until a mixture of the proper consistence is obtained. The article to be copied must be smeared with dilute glycerine before the mixture is poured on, and plenty of time must be given for it to set. When used for casting metals, add about 5 per cent of brick-dust to the mixture.

ACID-PROOF PORTLAND CEMENT.—Portland cement sinks or other castings are rendered acid-proof by immersing them in a bath containing a solution of 10 parts vaseline and 7 parts of paraffin at 104° Fahr. The casts should be thoroughly dry before being placed in the baths. If they are slightly warmed, the solutions will penetrate deeper. After the first bath, the casts should be taken out, allowed to drip until nearly dry, and then dipped again. Floors or other large surfaces may be treated in a similar manner by giving the surface from four to six coats of the hot solution. The surface must be thoroughly dry, free from dust, and the solution should be laid on with a brush, taking care that no surplus solution is left on the surface after each separate coat.

GREEK MASTIC.—This is made with 1 part of shell lime and 1 of fine river sand, and gauged to the proper consistency with skim milk and well beaten.

AQUARIUM MASTIC.—This mastic can be used for

fixing glass tanks, and if the angles are filled in they can be made without frames. It has also been used for waterproofing brick walls. It is made as follows:—Litharge, 3 parts; white or silver sand, 3 parts; resin, $1\frac{1}{2}$ parts; plaster, $1\frac{1}{2}$ parts, gauged with as much boiled oil as will make the mass of a plastic nature. The oil must not be added until required for use, as it sets quickly.

FIREPROOF MORTAR.—Two parts of the best lime, and one part each of blacksmiths' ashes and brick-dust, gauged with water or stale beer, as required. This makes a good mortar for plastering round coppers or fireplaces. It becomes as hard as iron.

WATERPROOF MORTAR.—The lime is slaked with a solution of green vitriol instead of water. The necessary quantity of green vitriol is dissolved in warm water, the lime slaked in the usual manner, and then mixed with sand.

TO HARDEN LIME AND CEMENT WORK.—Solutions of sulphate of zinc, sulphate of iron, and sulphate of copper are used for this purpose. The finished work may be brushed over with these solutions, or the mortar mixtures may be gauged with them. In the latter case, the percentage of lime or cement in the mortar can be considerably decreased.

LIME IN THE EYE.—Plasterers often get lime or other foreign substances in their eyes when at work, especially on ceilings, from splashes when gauging, or in cutting down old plaster. The plan generally adopted to clean the eye is for the half-blind plasterer to stand steady while his partner squirts water from his mouth into the injured eye, or licks the stuff out with his tongue. The efficacy of sugar and water in allaying the unpleasant smarting should be more generally known. A chemical action is produced by the combination of sugar and lime, which arrests the corrosive effects of the latter substance. When sand or other hard particle gets in the eye, most people rub with one hand, meanwhile searching for their handkerchief with the other. They sometimes do remove the sand, but more frequently they rub until the eye becomes inflamed. The better way is not to rub the eye with the sand in it at all, but to rub the other one, and the sand will soon work itself into the inner corner of the eye. Do not attempt to take it out, but rubbing as before, the sand will gradually run out on to the cheek; then wash the inside of the injured eye, or squirt sugar water into it; dry it, and pour one or two drops of olive oil in and around the eye.

TRACING PAPER FOR MOULDS, &c.—It sometimes happens that tracings of drawings are required, and when tracing paper is not handy, the following method

will prove a good and ready substitute. Damp ordinary drawing paper with pure benzine, and the paper (no matter how thick) will be as transparent as common tracing paper. The design can then be traced on it with either pencil or ink. The benzine will soon evaporate, and leave the paper white and opaque as before. If the design should not be finished before the benzine has evaporated, it is only necessary to damp it again. Paraffin oil may also be used for the same purpose. The above is useful for transferring moulding profiles when cutting mould plates, &c.

TO MIX COLOURS FOR VARIOUS TINTS.—The following mixings will be found useful for colouring setting stuff, concrete, sgraffitto, gesso, stucco, distemper, &c. Mixing black and red gives brown; white, yellow, and Venetian red gives buff; yellow and white gives straw colour; black, blue, and white gives pearl grey; green and white gives pea green; lamp-black and indigo gives silver grey; lamp-black and white gives lead colour; light green and black gives dark green; red, blue, and black gives olive; yellow and red gives orange; carmine and white gives pink; emerald green and white gives brilliant green; blue, white, and lake gives purple; Venetian red and black gives chocolate; lake, white, and vermilion gives flesh colour; and mixing white and lake gives rose colour.

TO PAINT CEMENT.—Caustic lime which is not in a state of combination in cement saponifies the oil used in painting. Consequently painting on cement is only practicable when, under the influence of the air, carbonic acid has united with the caustic lime to form carbonate of lime. Various expedients have been resorted to in order to allow the cement to be painted as soon as finished, but the best results have been obtained by the use of casein. Fresh white cheese and fresh slaked fat lime are added to the desired colour. This solution hardens rapidly, and is insoluble in water, a formation of albuminate of lime taking place. The solution, composed of 3 parts of cheese and 1 of slaked lime, is well mixed, and the colour added. Only earth colours, or oxides of iron, should be used. Inorganic colours, aniline, Prussian blue, and white lead should not be used. The caseous lime should be prepared as required for daily use. The mural paintings at the Berlin War Office were done with this solution.

Oil paint on cement is likely to be thrown off by the formation of crystals beneath it; while, if it remains in place, it usually presents a mottled appearance, owing to the unequal absorption of the oil from the paint by the cement. The common way of remedying both

these difficulties has been to wash the cement surface with acids before painting it. This dissolves any crystals that may have formed, and acts upon those spots in the cement which have become slightly carbonated by the action of the atmosphere, so as to restore the absorbent quality, which the formation of a superficial carbonate tends to diminish. Where acid is used, it should be sulphuric acid, made very dilute. Muratic and acetic acid, which are often employed, leave the cemented surface impregnated with chloride of calcium or acetate of lime, both of which are very deliquescent, and by keeping the surface damp, prevent the proper adhesion of the paint. A better application even than sulphuric acid is, however, to be found in carbonate of ammonia. The crystals of the ammonia carbonate should be exposed to the air until they effloresce partially into a white powder, which is bicarbonate, and more suitable for the purpose than the original carbonate. About $\frac{1}{4}$ lb. of the ammonia salt should be dissolved in 9 quarts of cold water, and the cement surface washed with the solution. As soon as it is dry, the paint may be applied, and will adhere well and resist the atmosphere. The carbonate of ammonia is best applied when the cement surface is about three weeks old. For prepared surfaces, perhaps older than this or more exposed to the weather, silicate of soda is sometimes useful. This should be prepared by dissolving the syrup silicate of soda of commerce in four times its bulk of water. Three coats should be applied, and after the last the wall must be thoroughly washed to remove any signs of silicate, or it will effloresce and throw off the paint.

ADAMANT COLOUR.—Portland or Roman cements, stone, brick, or wood can be coloured to any desired shade by the use of adamant wash, which was originally made by G. Cox, a Chelsea plasterer. It has been extensively used in London under various names. The following are the quantities and materials for a Portland stone colour, other colours being obtained by using different pigments. Into a large clean tub pour 18 gallons of water, adding as much whiting as will make it of the consistency of cream; stir it well, and pour in 1 gallon of linseed oil and 1 gallon of boiled oil; then mix 7 lbs. of umber and 7 lbs. of yellow ochre with 2 gallons of turpentine, and pour into the large tub. Add 6 firkins of size quite hot, and 1 lb. of alum dissolved in 1 gallon of hot water. Stir all together, and pass the liquid through a fine sieve into barrels. It is then ready for use. Apply it with a stock-brush. If the walls are old, two coats will be required.

CEMENT WASH. Cement wash is composed of Portland cement and water. A small percentage of

putty lime is added where a lighter shade is required. A solution of sulphate of zinc is sometimes added to give the wash greater permanency. Cement wash is used for colouring cement or stucco façades, walls, &c.

SANITARY WHITEWASH.—Whitewash is one of the most valuable sanitary articles in the world. Its cheapness and easy method of application bring it within the reach of all. It prevents not only the decay of wood, but conduces greatly to the healthiness of all buildings, whether wood or stone; out-buildings and fences should be done twice a year. There are various recipes for whitewash, but the following is one of the best. Into a large clean tub put 1 bushel of lime, and slake it with boiling water, covering it up during the process to keep in the steam; strain the liquor through a fine sieve; then add 3 lbs. of sulphate of zinc, 1 lb. of alum, and 2 lbs. of common salt, the alum and salt being previously dissolved in hot water. Various colours are obtained as follows:—For a cream colour, add 3 lbs. of yellow ochre; pear or lead colour, add lamp, vine, or ivory black; fawn colour, add 6 lbs. of American umber, 3 lbs. of Indian red, and 1 lb. of lamp-black; for stone colour, add 8 lbs. of raw umber and 4 lbs. lamp-black; terra-cotta colour, add 4 lbs. Venetian red, 2 lbs. of purple brown, and 2 lbs. of yellow ochre. Limewash with 1 lb. of coarse brown sugar added to each 15 gallons of water, will adhere so firmly that splashes on wood or iron will require to be scraped off.

FIREPROOF WHITEWASH. Slake freshly burnt lime; add as much water as will reduce it to the consistency of cream. To every 10 gallons of this liquid add 2 lbs. of alum, 24 oz. of subcarbonate of potash or commercial potash, 1 lb. of salt, and 1 lb. of plaster. The above are added separately, and in the order named, being constantly stirred. The whole is then passed through a fine sieve. When required for use, it is heated to boiling point, and applied in a hot condition. If the wash is intended for old walls, the addition of a small quantity of fine sand will tend to preserve and strengthen crumbling walls.

A CHEAP WHITEWASH.—A good whitewash, that will not peel or crack, is made by adding 1 part salt to 3 parts stone lime. If used for granaries, sheds, or where there is a difficulty in fixing scaffolding, it may be quickly applied by using a hand fire-engine or a large squirt.

A BRILLIANT WHITEWASH.—Take half a bushel of good unslaked lime, and slake it with boiling water, covering it during the process to keep in the steam. Strain the liquor through a fine sieve, and add to it a peck of clean salt previously dissolved in warm water, 3

lbs. of rice ground to a thin paste, and stirred and boiled hot, $\frac{1}{2}$ lb. of powdered Spanish whiting, and 1 lb. of clean glue, previously dissolved by soaking it, and then melting in a water bath. Add 5 gallons of hot water to the whole mixture. Stir it well, and allow it to stand for a few days well covered up to prevent dust getting at it. The whitewash should be laid on quite hot. This can be done by heating on a stove as required. One pint of this liquid will cover a square yard of surface. This whitewash retains its brilliancy for years.

MOULD-PROOF WHITEWASH.—Whitewash when used in cellars or dairies is liable to turn mouldy. This may be prevented by adding 1 oz. of carbolic acid to each gallon of whitewash.

WASHABLE WHITEWASH.—Herr Reschenschek gives the following quantities to form a washable whitewash, which, it is said, will not lose colour, and the hardness of which will increase by wetting and washing. Mix 3 parts siliceous rock powdered, 3 parts crushed marble or sandstone, 2 parts porcelain clay, 2 parts warm freshly slaked lime. This will form a wash, which in time will solidify like stone. Any colour which can safely be used with lime can be added to the ground colour. The wash is put on thick, allowed to stand for a day to dry, then frequently wetted with water, and it soon becomes waterproof.

LIMEWASH FOR WALLS.—Reduce well-slaked lime to a thin solution with water. Dissolve $1\frac{1}{2}$ lbs. of rock alum in boiling water, and add cold to each pail of limewash.

TO MAKE WHITING.—Whiting is pure white chalk ground to a fine powder. It is mixed with water and size for whitening walls and ceilings. It is made as follows:—Take 6 lbs. of whiting and just cover it with clean cold water, let it stand for six hours, mix it with one quart of best double size, and then leave it in a cold place until it becomes like a jelly. It is then diluted with water until of a thick creamy consistency. One lb. of the jelly will cover six superficial yards.

TO MAKE CLEARCOLE.—Clearcole is size, sometimes mixed with whiting or other colouring matter, but generally it is size alone, and used as a priming, or first coat, to stop absorption in plaster work.

DISTEMPERING.—Distemper, or destemper, from *tempera*, a term used in fresco painting, is applied to water-colours or pigments ground in water, beer, &c. Painting scarcely comes within the category of plastering, but distempering (also whitewashing) was a part and parcel of the plasterer's craft in ancient times.

Even at the present time this kind of work is done by plasterers in many parts of the country, therefore a brief description of distempering is here given.

The preparation of ceilings and walls for the finishing in distemper is of vital importance to the ultimate result, inasmuch as if they are not properly prepared they will rarely turn out well at the finish. The first thing to be done is to stop the suction, for except the finishing colour lays on cool, and without any or very little suction, the work is apt to be more or less rough, and will gather or accumulate more colour in one part than in another, and consequently will look shady. And here the fact may be noted which shows the necessity for the use of a preparation. It will almost invariably be found that one part of a wall or ceiling will have a greater power of absorbing colours than another part. It will be observed, as with a first coat of paint, that some parts are glossy, and others dry dead, that is, the paint has sunk into or been absorbed on the dead parts, while on the glossy part it remains on the surface, owing to the unequal finish of the plaster work. Of course, in oil painting this is remedied by successive coats of paint. It therefore becomes necessary that some means should be adopted to stop this power of absorption, and for this purpose various preparations are used. The following has been recommended as a suitable preparatory coat, and will be found to answer the purpose very effectually. "Mix about 12 lbs. of the best whiting with water to the consistency of soft paste. Add sufficient parchment or other size to bind the colour fast. Add about 2 oz. of alum, and the same weight of soft soap dissolved in water. Mix well together in a pail, and strain through a coarse cloth or a metal strainer." Of course somewhat similar proportions will answer for any quantity. The colour should now be tried on paper, and dried before a fire or otherwise, in order to test whether sufficient size has been used to "bind" the colour, and to prove that the tint is exactly what is required. The finishing coat can be laid on without disturbing the first one. The alum and soft soap contribute to this effect in a great degree, and help to form a semi-impervious coating upon which the finishing coat will work cool and without suction. Caution must be observed not to have the size too strong, or it will be very liable to chip, especially in rooms where much gas is used.

In order to produce good work, two things are essentially necessary in the mixing of the distemper, namely, clean and well-washed whiting and pure jellied size. The whiting should be put to soak with sufficient soft water to cover it well and penetrate its bulk. When the whiting is sufficiently soaked, the

water should be poured off, which will remove any dust or foreign matter from the whiting. It should then be beaten up or stirred until all the lumps are broken, and it becomes a stiff smooth paste. A good workman will do this carefully with his hand, and will manipulate it until it is quite smooth; but it may be done most effectually with a broad stick or spatula, and then strained through a metal or other strainer. The size should now be added, and the two lightly but effectually mixed together. Care should be taken not to break the jelly of the size any more than can be avoided, and this may be best done by gently stirring the mixture with the hand. If the jellied state is retained intact, the colour will work cool and lay on smooth and level. Then size, whether made of parchment clippings, glue, or any other material, should be dissolved in a sufficient quantity of water to form a weak jelly when cold. In practice it is found that distemper mixed with jellied size will lay on better and make a better job than when the size is used hot. Colour mixed on the former plan works cool and floats nicely, while the latter works dry, and drags and gathers, thus making a rough ceiling or wall, and the difference in the labour required is very much in favour of the jellied size. A little alum added to the distemper has a good effect in hardening, and helps it to dry out solid and even. It is customary in some cases to give the ceiling or wall a couple of coats of oil paint previous to the application of the distemper. This stops the suction and gives a richness to the colouring; but it, as frequently happens, the wall gets low in temperature during a continuance of cold weather, when a change takes place the condensation is so great that the water runs down in streams to the top of the skirting, and the colouring matter thereby becomes stained.

With regard to the method of laying on distemper colours, it may be accepted as a fact that the sooner they dry after they are laid on the better. The best plan is to close the windows and doors, and stop the free circulation of the air as much as possible while the distemper colour is being laid on. This prevents it drying too quickly, and enables the workman to lay the colour on more evenly and with less danger of showing any pieces; but the moment that the wall or ceiling is covered, the windows and doors should be thrown wide open, and as much fresh air admitted as possible. This free circulation of air absorbs and carries off the moisture from the walls. The evaporation is quick, and a good job results. If the distemper does not dry quickly, it becomes slightly discoloured and shaded. One great point to be aimed at is, of course, a level and uniform surface when dry, and this desirable result can only be obtained by the colour

being laid on of a proper consistency, and with every attention to equality.

When ceilings are badly stained and discoloured from the accidental overflow of cisterns, water-closets, &c., the only effectual method of treating them is to wash them off with clean water, and give two coats of oil paint before the distemper is applied. Other processes are adopted, but as they cannot be depended upon, it is much better, in the first instance, to incur a little extra expense, and paint the discoloured ceiling in oil colours.

The following hints for mixing various colours in distemper, &c., by which at least a theoretical knowledge of the subject can be acquired, which will greatly facilitate progress in mastering the practical details, are given by the author of the "Painter's and Grainer's Handbook."

The best size for distemper colour is made from parchment clippings. These are put into an iron kettle filled with water, and are allowed to stand for twenty-four hours, until the pieces are thoroughly soaked; then boil for five hours, occasionally taking off the scum. When the liquid is sufficiently boiled, take it from the fire, and strain it through a coarse cloth. If the size is to be kept for a length of time, dissolve 3 oz. or 4 oz. of alum in boiling water, and add to every pailful. The size must be boiled again till it becomes very strong. It must then be strained a second time, put into a cool place, and it will keep for several weeks. It is cheaper and safer to buy size ready-made from a maker of good repute.

PINK. Dissolve in water separately whiting and rose pink. Mix them to the tint required, strain the colour through a strainer, and bind the size.

LILAC.—Take a small quantity of indigo, finely ground in water, and mix it with whiting till it produces a dark grey; then add to the mixture some rose pink. Well mix and strain the colour, and a beautiful lilac will be the result.

LIGHT GREY.—A small quantity of lamp-black mixed with whiting composes a grey. A wide range of shades may be obtained from the darkest to the lightest grey.

FRENCH GREY. Take the quantity of whiting required, and soak it in water, then add Prussian blue and lake which have been finely ground in water. The quantity of each of these colours should, of course, be proportioned to the warmth of tint required. This is a handsome and delicate colour for walls. Rose pink may be substituted for the lake; but it does not make so brilliant a colour, neither is it so permanent.

ORANGE.—This is a mixture of whiting, French yellow or Dutch pink, and orange lead. These ingredients may be proportioned according to taste. This colour cannot be worked except in a size jelly, as the orange lead is a colour which has great density, and will sink to the bottom, separating from the other colours.

BUFF.—A good buff may be produced by dissolving separately whiting and yellow ochre in water. A little English Venetian red should be added to give a warm cast. Mix with size, and strain as before directed.

DRAB.—(1.) Dissolve whiting in water, and grind some burnt umber very fine in water. Mix to the tint required. Raw umber will make a drab of a different shade. (2.) Dissolve separately some whiting and yellow ochre in water. Take a quantity of each, and mix them together. Grind a little lamp-black very fine, and with it sufficiently stain the colour to make the tint required. (3.) Another shade may be obtained by adding a little Venetian red. By diversifying the proportions of these pigments a great variety of colours may be produced. These are all permanent colours, and may be depended upon.

SALMON.—An excellent salmon colour may be made by dissolving whiting in water, and tinging it with the best English Venetian red. A little Venetian red, mixed with lime whitewash and a quantity of alum, will answer very well for common purposes.

PAINTS AND WASHES.—The following paints and washes, which are extensively used in America, will be found useful for various purposes:—

FLEXIBLE PAINT.—Slice $2\frac{1}{2}$ pounds of good yellow soap and dissolve it in $1\frac{1}{2}$ gallons of boiling water, and grind the solution while hot with $3\frac{1}{2}$ gallons of good oil paint. It is used to paint on canvas.

NEW PAINT FOR FLOORS, STONE, PLASTER, WOOD, AND BRICKWORK.—This new paint has the advantage of saving oil and lacquer, being simply a combination of glue, oil paint, and lime, and for wooden floors an addition of shellac and borax. To prepare the ground mixture, soak 2 ounces of good light-coloured glue for 12 hours in cold water, and dissolve it, with constant stirring, in thick milk of lime (prepared from 1 pound of caustic lime) heated to the boiling point. To the boiling glue stir in linseed oil until it ceases to mix. About $8\frac{3}{4}$ fluid ounces of oil is sufficient for the above proportions. Too much oil is corrected by addition of lime paste. Mix the above with any colour not affected by lime, and dilute with water if needed. For yellow-brown or brown-red colours, boil in the

ground colour $\frac{1}{4}$ of its volume of a solution of shellac and borax, making an excellent paint for wooden floors. The mixture is easily applied, covers well, and forms a durable combination with any covering, and, as any desired shade can be produced by an addition of proper colours, it may often be substituted for more expensive paints. A simple coat of varnish or lacquer gives a beautiful lustre.

CHEAP AND DURABLE PAINT FOR BRICKWORK.—Slake fresh-burnt lime to a powder by sprinkling water upon it, and pass the powder through a sieve. To 100 parts of this powder add sufficient water to form a thin milk of lime, and boil it in a copper boiler, and add 1 part of bichromate of potassium. Make a thin paste of sulphate of lead with water, and stir it in the boiling mixture. Sugar of lead or the nitrate of hydrochlorate of lead can be substituted for the sulphate of lead. Add cold water to the mass and pass it through a fine wire sieve, drain it off through linen or cloth bags, and press the residue remaining in the bags. After sufficient pressing, break into pieces and dry in the air.

TO PREPARE A ZINC WASH FOR ROOMS.—Mix oxide of zinc with ordinary milk of lime, and apply the mixture in the same manner as whitewash. When dry lay on a coat of solution of chloride of zinc. This combines with the oxide, and forms a solid coat with a lustrous surface.

PAINT FOR OUTSIDE WALLS.—Boil 1 pint of clear linseed oil, $4\frac{1}{4}$ ounces of rosin, and 3 ounces of litharge until the wooden spatula used for stirring becomes brown. Give the walls two or three coats of this. It is best to do the work on a hot summer day.

RED WASH FOR BRICK FLOORS AND PAVEMENTS.—Wash the bricks with soap water containing $\frac{1}{16}$ part of carbonate of soda. This cleanses the floor and prepares it for the reception of the wash. Then dissolve 1 part of glue in 16 of boiling water, add 4 parts of red ochre, and stir the mass thoroughly together. Apply two coats of this to the bricks, and then give a coat of linseed oil varnish.

PARAFFIN PAINT.—A solution of paraffin in heavy coal-tar oil is excellent for painting houses, and especially walls, exposed to the action of the weather. Several experiments in painting damp walls with this solution have given very satisfactory results. Wallpaper, which formerly became moist and detached from the walls during rainy weather, remained perfectly dry after the wall had been painted with paraffin in heavy coal-tar oil. It is prepared by dissolving 1 part of paraffin in 2 to 3 parts of coal-tar oil at a moderate heat. A sufficient quantity of oil must be used, so

that the solution does not entirely congeal on cooling. To heat the paint while applying it, place the vessel containing it in hot water. It is best to apply the solution on a warm day, when the bricks are dry. Generally one coat is sufficient, but even if two coats are given, the cost is considerably less than oil paint.

QUICKLY DRYING OIL PAINT.—Boil for 15 minutes in an earthenware pot 1 part of soft curd in 3 parts of water. Pour the mass through a colander, wash it with cold water, and press out the water in a linen

cloth. To 1 part of the curd add $\frac{1}{4}$ part of unslaked lime and $\frac{3}{4}$ part of water. The fat slime thus formed is triturated in oil or water with the various pigments. Walls, ceilings, stairs, in short anything of stone, plaster of Paris, or zinc, can be painted with this. If the paint is to be used on wood, add $\frac{1}{8}$ part of linseed oil. Ochre, chrome yellow, Berlin blue, indigo, lead, and zinc are best adapted for colouring substances. The mixture dries so quickly that three coats can be applied in one day. It is entirely without odour, and costs about one-third of ordinary oil paint.

III.—GLOSSARY OF ARCHITECTURAL AND PLASTIC TERMS.

Abacus, the top moulding of a capital. The word is derived from the Greek word *abax*.

Acanthus, a plant popularly named Bear's Breech, whose leaves are used for decorating the Corinthian and Composite capitals. Parsley and laurel leaves are also used for the same purpose.

Acroteria, the small pedestals at the extremities and apex of a pediment. They were originally intended to support figures. They are sometimes called Pinnacles. The word is Greek, and signifies "the extremity."

Aggregate, the literal meaning is the conjunction of many particles held or bound together by the matrix.

Angle, the arris or edge, salient or receding, formed by the conjunction of two surfaces not in the same plane.

Angle-bead or **Angle-staff**, a round member at exterior angles, formed by plastered surfaces.

Arch, an arch is a structure composed of separate masonry bodies, having the shape of truncated wedges, and the vertical forces due to the weight of the materials are transmitted to the supports or abutments in a curved line, known as the curve of equilibrium. It is a support to the superstructure, and is either circular or elliptical. The arch is the most important discovery in architecture. When or where it was invented is uncertain.

Architecture, the science which teaches the art of constructing buildings for the requirements of mankind. The design of a building is generally laid out in three parts. The first is the plan, which shows the extent, division, and distribution of the ground into apartments, &c. The second is the elevation, which shows the various stories, their heights, and the outward appearance of the whole building. The third is the section, which shows the inside or centre parts. There are five classic orders—the Doric,

Tuscan, Corinthian (Greek), Ionic, and Composite (Roman).

TABLE XXV.—BEGINNING AND DURATION OF THE MORE MODERN STYLES OF ENGLISH ARCHITECTURE.

Name.	Prevailed.	General Characteristics.
Norman	1066 to 1154	Round-headed doorways and windows, heavy pillars, and zigzag ornaments.
Early English	1189 to 1272	Narrow pointed windows, clustered pillars.
Decorated	1307 to 1377	Geometrical tracery in windows, enriched doorways.
Perpendicular	1487 to 1547	Upright lines of mouldings in windows, and doorways often a combination of square heads with pointed arches.
Elizabethan	1558 to 1600	A species of Perpendicular; enriched interiors; strap-work ornaments.
Jacobean	1603 to 1702	Admixture of classic and Gothic, with beautiful and elaborate interiors.
Queen Anne	1702 to 1760	Free classic treatment, quaint mouldings and ornament.

Pure Gothic was first introduced in 1272.

"Transition" is a term applied to the interval which elapses between one style and the full development of the next. It is usual to allow the period of about twenty-five years for the change of one style to the other.

Architrave, the lowest member of the entablature, and is composed of one or more faces, according to the order.

Archivolt, the moulding round an arch.

Arris, the external angle or edge formed by the meeting of two planes or curved surfaces.

Artist, a skilful man in arts and crafts: not a novice.

Astragal, a small round moulding which encircles the top part of the shaft of a column, and separates the shaft from the capital. The astragal is also termed a talon, and is cut into beads, and used in decorated entablatures to separate the faces of the architrave.

Axis, the line, real or imaginary, that passes through anything on which it may revolve.

Baluster, a small round or square pillar or pilaster, serving to support a rail or cornice, generally ornamented with mouldings or other decorations.

Balustrade, a connected series of balusters surrounding balconies, terraces, parapets, steps, staircases, tops of houses, &c. They are sometimes used solely as ornaments.

Band, a flat, low, square profiled member.

Base, the lower part of columns, pedestals, &c.

Bas-relief, a model or cast in which the figure or figures do not project in full from the ground. There are three kinds of reliefs, which are usually termed the flat relief (*basso-relievo*); the high relief (*alto-relievo*), which shows the figures standing well out from the ground; and the *mezzo-relievo*, which gives the half-raised figures. Each relief has many intermediate shades or heights.

Bay, in plastering, is used in a compound form. *A bay of plastering* is the part between two screeds, mouldings, or beams.

Bay Window, a bow window, one projecting beyond or from the general surface of the building. It is usually of a semi-polygonal form, and sometimes semicircular or semi-elliptical. An oriel window is similar to a bay, but does not descend to the ground, and is suspended over the face of the wall beneath it.

Bead, a small member of a semicircular form. It is sometimes cut or modelled in a globular form, either close together or slightly apart, and connected by a small stem running through the centre. This form is commonly called a "bead and reel."

Bead and Quirk, a bead on the edge of material flush with its surface.

Bed Moulding, the term is generally applied to the mouldings in all the orders between the corona and frieze. They are usually enriched.

Bell, the inverted bell or drumlike ground on which the leaves and other enrichments of a capital are placed.

Bevel, any angle except one of 90°. Anything

that is not square is generally called a bevel angle, whether it is more obtuse or more acute than a right angle.

Blister, a scaly protuberance on the surface of plaster work, caused by the blowing or bursting of improperly burnt or slaked lime, or by the presence of foreign matter.

Blub, a trade term for holes in moulds, casts, and plaster work, caused by contained air and careless manipulation of the materials.

Boning, the operation of levelling by means of the eye. It is performed by placing two parallel straight-edges on an object, and sighting on their upper edges to see if they range. If they do not, the surface is said to be "in wind" or "winding."

Boning-rods are used for boning. A boning-rod is made in the shape of the letter T. The head gives the sighting point.

Boss, a Gothic enrichment. It is used at the intersections and ends of Gothic mouldings.

Bracket, a skeleton support for plaster mouldings, also for saving materials. Brackets are made of wood (and in a few instances metal), and are sawn to the required contour and nailed into position. They form a basis for the lath and plaster, or fibrous plaster, slabs, panels, or large mouldings used in the formation of arches, domes, beams, sunk panels, columns, &c. In domed work, *spherical* bracketing is the forming of brackets to support plaster work, so that the surface of the plaster shall form the surface of a sphere. Spheroidal bracketing is the bracketing prepared for a plaster ceiling, whose surface is to form that of a spheroid. The word bracket is also used for an ornamental tapered truss or support.

Bust, a portrait statue of a person. A bust comprises the head, shoulders, and breast. Lysistratus, the sculptor, is cited as the inventor of busts, &c., cast from moulds, B.C. 328.

Camber, curved upwards to the centre to compensate for settling, as in a beam or a lintel.

Cantilever, the same as truss, but the term is generally used where the projection is greater than the length, for instance a truss supporting a balcony.

Capital, the head or top part of a column or pilaster. It generally consists of three parts. The first is the astragal or necking; the second is the bell, which is enriched with foliage, scrolls, &c.; and the third the abacus, which is the top or finish of the capital.

Carcase, the naked shell of a house without floors or plastering.

Caryatides, female figures serving as columns or pilasters to support entablatures, &c. Male figures for

the same purpose are termed *Prostrans*, *Atlantes*, also *Talmones*. They were only employed by the ancients when pillars were too insignificant for the erections.

Case, a plaster frame to keep the various parts of the mould in position.

Cast, an object produced from a mould.

Cauliculus or **Caulicoli**, the volutes or scrolls under the abacus of a capital.

Cavetto, a hollow member of a moulding, whose profile is a quadrant of a circle.

Ceiling, in architecture, is the plaster or other covering at the top or upper surface of a room upon the under side of the joists. An inner roof.

Cement, in building, is an artificial compound forming a hard, strong, and binding plastic mortar.

Chamfer, to cut off to a sloping edge, the arms out or splayed.

Chord, a line in a circle connecting the two ends springing of a circle or arch.

Cinque-cento, a term generally architecturally applied to the revival of art coeval with the Early Tudor style in England and the Renaissance style in France.

Cinque-foil, an ornamental foliation or feathering, used in the arches of the lights and tracery of windows, panellings, &c.

Clay, a name given to hydrous silicates of alumina derived generally from the decompositions of some of the older rocks. These are slate clay, fire clay, plastic clay, China or porcelain clay, common clay or loam. Specific gravity, 2.0.

Coat, a stratum or thickness of plaster done at one time.

Coffer, the space in the scffit between the moldings, often containing round or square paterae. Coffers are generally used in the five orders, the Tuscan excepted. The term is also used for deep sunk square panels in flat or arched ceilings.

Concave, hollow, the opposite to convex.

Concrete, to "concrete" means to coalesce into one mass. In France it is termed *béton*.

Console, a French term for a truss or support.

Contour, outline or profile of any member, moulding, or body.

Convex, rising in a circular form, the opposite to concave.

Core, the inner part of a capital or other large body on which the plaster or cement is run. The core is to save materials and weight, and also to prevent an unnecessary body of plaster, which would cause undue swelling or expansion.

Cornice, a projection consisting of several members which crowns or finishes an entablature, or the body or wall to which it is annexed.

Cove, a hollow curved member or space in a moulding, above, below, or between mouldings. A cove may either be plain or enriched.

Crocket, a Gothic ornament which creeps up mouldings.

Cusp, an ornament in the Gothic and Saracenic styles. It consists of projecting points formed by the intersections of curves of mouldings.

Cylinder, a circular wood frame, lathed and plastered, to form columns or other circular work.

Dado, the lower part of a wall, or space between the base and surbase.

Datum-line, the horizontal line of a section from which all heights and depths are taken or calculated.

Daubing, an ancient term for rough plastering.

Dentils, small oblong square blocks used in the bed mouldings of the cornices in the Ionic, Corinthian, Composite, and sometimes the Doric orders. Their breadth should be half their height, and their intervals two thirds of their breadth.

Dubbing or **Dubbing-out**, a mode of bringing a hollow or uneven surface to a fair one, to receive the usual thickness of plaster work. It is accomplished by fixing pieces of tile, slate, bricks, or lath with gauged coarse stuff, cement, or nails.

Dutch-rush, a fine fluted reed having a sharp file-like surface. It is used for taking seams of casts and for cleaning up plaster and cement cast work. It is superior to glass paper, as it is not so readily affected by damp. It is also used for wet polishing plaster, cement, and wax.

Egg-moulding, is the ovolo or quarter round, enriched in the form of an egg and dart, or sometimes an egg and anchor, or a tongue. It is said that the egg signifies life, the dart death, the anchor hope, and the tongue speech.

Eiorchee, or **Anatomical figure**, signifies the subject man or animal deprived of its skin, so that the muscular system is exposed for the purpose of study.

Ellipse, a part of an oval, a curve produced from two or more centres.

Entasis, the swelling in the shaft of a column.

Facade, the face or front of a building.

Fascia, a flat member or broad band, generally used in the architrave of the more elegant orders. They are divided into three bands; the lower called the first fascia, the middle one the second, and the upper one the third fascia.

Fence, a clay, plaster, wood, or metal guard to enclose a mould or cast, to prevent the escape of wax or other liquid material.

Fillet or **List**, the small square member placed above or below the various square or curved members

in an order or cornice. Wood fillets are strips of wood generally about $1\frac{1}{2}$ in. wide, 1 in. thick, and in various lengths.

Finial, the ornament which forms the external termination of a Gothic pinnacle or other point.

Fish-skin, the dried skin of the dog-fish. It is durable and resists damp, therefore useful for smoothing and polishing wet surfaces.

Flush, a term used to signify a continuity of surface in two bodies joined.

Foliage, ornamental scrolls or lines formed with stems, branches, and leaves. The serrations of ornamental leaves are termed lobes.

Fret, from a term used in heraldry. An enrichment consisting of one or more bands, generally straight, and forming various squares and parts of squares.

Frieze, the middle member in the entablature which separates the architrave from the cornice. In the Tuscan order it is always plain; in the Doric it is enriched with triglyphs; in the Ionic it is sometimes swelled; in the Corinthian and Composite orders it is enriched with figures or foliage. The term is also applied to decorated longitudinal wall surfaces.

Furr, a white scaly lime substance which often forms on the surface of moulds.

Furring, nailing wood fillets on joists and rafters to strengthen them, or to make the surface straight and level to receive lath and plaster or fibrous slabs.

Gargoyle, a grotesque Gothic ornament, generally used as an outlet for water.

Gauging, the accurate gauge of quantities, and the proper mixing of different materials.

Glyphs, the vertical channels in the triglyphs of the Doric order.

Groin, the line formed by the intersection of two arches which cross over each other at any angle.

Groined Ceiling, one formed by three or more curved surfaces, so that every two or more may form a groin, all the groins terminating in one point.

Groined Vaulting, a vault which is formed by groins springing from various points and intersections.

Grounds, the plaster surface on moulding pieces for moulding purposes. In carpentry, pieces of wood fixed to walls and partitions, with their surfaces flush with the plaster, to which the facings or finishings are attached.

Guilloche, an ornament somewhat like a fret, but having two or more bands turning over or interlacing with each other, so as to repeat the design.

Gypsoplaste, a cast taken in plaster.

Gypsum, sulphate of lime, called plaster of Paris, also "plaster" after it is calcined.

Helix, the small volutes under the abacus of the Corinthian capital.

Hexagon, a figure having six sides.

Hexastyle, a building having six columns in front.

Hollow, a term in architecture, sometimes used for a concave member.

Impost Moulding, the horizontal moulding along the tops of piers (where the arch springs from): the moulding round the arch is called the archivolt.

In situ, in the permanent or original situation.

Jerry-builder, jerry-work, a cant term for a scamper, or scamp work. The term originated from a firm named Jerry Brothers, builders, who carried on work in Liverpool in the early part of this century. This firm gained an unpleasant notoriety for rapidly building showy but ill-constructed and insanitary houses with cheap labour and materials. The equivalent for "jerry-builder" in America is Buddensick, a builder who used to run up gaudy and flimsy houses in New York. In Germany the jerry-builder is known as the "Bauschwindeler."

Joggle, the joint of two bodies constructed with corresponding raised and sunk parts, to prevent them sliding past each other.

Key stone, the centre or highest stone in an arch.

Matrix, derived from the Latin, its literal meaning being a mould in which anything is formed. It is also used to designate any cementing material.

Model, the original from which a copy or a mould is taken: also a pattern, usually on a small scale, of work which has been or is to be done.

Modeller, one who designs and makes models in clay, plaster, wax, &c.

Modelling. The forming of figures, models, and works of art, from which copies are to be reproduced: also modelling figures and ornaments direct in the final material, such as terra-cotta, clay, which is subsequently baked), plaster, cement, gesso, &c., either in a studio or *in situ*. The invention of the art of modelling in clay is attributed to Dibutades, the Corinthian, about 985 B.C. His daughter traced the profile of her lover, by his shadow on the wall, and her father filled up the outline with clay, which he afterwards baked. Had Pliny known more of Egypt and Phœnicia he might have made a more accurate statement, as shown in Chapter VIII. Vases, pots, &c., had been made in rude resemblance of faces, figures, and foliage, for unknown ages past.

Modillion, also termed Block, an ornament like a small bracket or console, used beneath the corona of the richer orders.

Module, a measure of proportion, the lower diameter of the shaft of a column.

Mould or Matrix, a reverse pattern of a model in which a cast is formed. A "running mould" is used to run or form plastic mouldings. A "reverse running

mould is used to form a casting mould. A "reverse casting mould" is one made without the aid of a model, being made the reverse of a model.

Mouldings, those parts of an order which are composed of various curves and squares. The parts are often termed members.

Moulding-piece, a model or original with a ground, or otherwise constructed to mould from. In some parts it is called a "solid."

Niche, a square or circular cavity in a wall or other solid. It is from the Italian *Nicchia*, a shell.

Oblique Angle, an angle that is greater or less than a right angle.

Oblong, a rectangle of unequal dimensions, a figure longer than broad.

Obtuse, anything that is blunt, the opposite to acute or sharp.

Ogee or **O.G.**, the same as Cyma.

Ogives, arches or Gothic vaults which, instead of being circular, pass diagonally from one angle to another, and form a cross between the other arches, making the side of the squares. The centre or intersection is called the key, and is generally covered with a boss or pendant.

Original, a first design or model. The term is also applied to a moulding piece.

Pediment, the triangular crowning ornament of the front of a building, or of a door, window, or niche.

Planting, fixing any part of a moulding or an ornament on the main part of the work.

Plaster, in Old English written *plaster* from before 1745 to as late as 1783; Greek, *ἐπιλαστρον*; Latin, *Emplastrum*; French, *Plâtre*. A term loosely applied to any form of gypsum, cement, or mortar. A common name for calcined plaster. **To Plaster**, to overlay or cover with plaster, to render fair unequal and rough surfaces, to hide defects.

Plasterer, one who plasters or overlays the carcase or skeleton of a building, to form plumb, level, smooth, and hard surfaces; one who forms plastic mouldings, enrichments, and figures. "Thy father was a plasterer" (Shakespeare). "The plasterer doth make his figures by addition" (Sir H. Wotton).

Plasterers' Work or **Plastering**, French, *Chape*; German, *Ueberschutt* (*Lukium* or Turkish plaster). Work composed of plastic materials executed by plasterers.

Plasterly, resembling plaster. "Out of gypseous or plasterly grounds" (Duller).

Plastery, of the nature of plaster.

Plastic, in Greek, *πλαστικός*; Latin, *Plasticus*; French, *Pastique*, fit for moulding. A combining form signifying developing, forming, growing, as heteroplastic, monoplastic, polyplastic; having the power to

give form or fashion to a mass of matter, as "The plastic hand of the Creator" (Prior); "See plastic nature working to this end" (Pope). Capable of being formed or modelled as clay, plaster, or cements; pertaining to or characteristic of modelling, moulding; said of sculpture and the kindred arts, in contradistinction to painting and the graphic arts. "Medallions . . . fraught with the plastic beauty and grace of the palmy days of Italian art" (J. S. Harford).

Plastography, the art of forming figures in plastic materials.

Plinth, the square solid part under the base of a column, pedestal, or wall.

Plug or Dook, a wedge-shaped piece of wood driven into the wall, as a means for fixing wood or fibrous plaster.

Profile, the contour of the different parts of an order or moulding, &c.

Puttogs, pieces of timber about 7 ft. long, principally used for outside scaffolds.

Quirk, the recessed or sunk part placed at the side of a bead or moulding, much used in Gothic architecture. In Grecian architecture ovolos and ogees are usually quirked at the top, and sometimes in Roman. A "double quirk" is when both sides of a bead or moulding are recessed.

Quoin, the square or rectangular stones or projections at the exterior corners of a building. They are generally disposed in the way known as "longs and shorts," a short one between two long ones.

Rabbit, a channel or groove, an overlapped joint.

Radius, the straight line drawn from the centre to the circumference.

Raffling, the serrated or notched edges of leaves or foliage.

Renaissance, the name given to the style which revived the forms and ornament of Roman and Grecian arts. It was commenced by Italian artists of the fifteenth century. The style is called "Cinque Cento" in Italy, and "Elizabethan" in Great Britain.

Rims, of casts, the bearing or fixing parts.

Rims, of moulds, the ruling-off edges.

Rococo, a debased Renaissance style of the time of Louis XV. and XVI.

Rose, the round flower placed in the centre of each side of the Corinthian capital; a circular ornament; a flower.

Run-down, mouldings that are run on a board or a bench for fixing purposes.

Rustic, courses of stone left with jagged or irregular surfaces.

Septaria, the petrified excreta of extinct animals, found in nodules in various parts, and used in the manufacture of Roman and similar cements.

Setting, the quality that any material possesses of getting hard in a short time. The term is also used for the finishing coat of plaster work.

Soffit, from the Italian *Soffito*, the under part of the corona; also the under part of ceilings, doors, arches, stairs, &c.

Solid Work, a modern trade term used to distinguish lime or cement plaster work laid on walls or ceilings from fibrous plaster work.

Spaced Ornaments are those fixed with a space between them.

Spandrel, spaces, either plain or enriched, between an arch and the square formed round it; also the space between a circle and square angle.

Stairs are of various kinds, as straight-fliers, square-fliers, triangular-fliers, winding stairs, and mixed stairs.

Stopping, the filling up and making good small cracks or other defects in plaster or cement work.

String Course, a horizontal projecting moulding in a wall.

Suction, the tendency of any porous material to absorb moisture.

Tempered, a term used to denote the mixing of plastic material. Well-tempered stuff means that the

materials are thoroughly incorporated and in a plastic state by being properly mixed and worked.

Tensile Strength, the resistance to extension or stretching.

Torso, in sculpture, is a body without arms or legs.

Torus, a moulding of semicircular form used in the bases of columns.

Tympanum, the space enclosed by the cornice of the sides of a pediment, and the level fillet of the corona.

Volute, the scrolls at the angle under the abacus of capitals. In plasterers' parlance they are called "horns."

Voussoirs, the stones that form an arch.

Weathering, a splayed surface to allow water to run off.

Well of a Staircase, the enclosed or open space reaching from one floor of a building to another, in which the stairs or staircase is erected.

Well-hole, in a flight of stairs the space left in the middle, beyond the ends of the steps.

Winders, those steps of a stair which, radiating from a centre, are narrower at one end than the other.

Zero, the commencement of a scale marked 0, or nothing. It usually denotes the point from which the scale of a thermometer is graduated.



INDEX.



- A** BACUS, use and position of the, 524
 Acanthus leaf, the, 298
Acanthus mollis, the, 529
 Acid-proof Portland cement, 568
 Acroteria, use of, 452
 Act passed to fine non-members for plastering, 548
 .. restricting plasterers from painting, 30
 Adam, Robert, ceiling by, 34
 .. his influence on plaster work, 22
 .. his style, 33
 Adamant cement, 76
 .. covering capacity of, 555
 Adhesive strength of limes, 44; Portland cement, 503
 Adie's cement testing machine, 59
 Adjustable calipers, 235
 Adulteration of materials a penal offence, 549
 evil effects of, 105, 549, 551
 Affinity of Portland cement, 465
 Aggregates, 460, 461, 462, 463, 464
 .. bad, spoil good matrices, 471
 .. care in selection of, 462
 .. compound, 462, 470
 .. fireproof, 463
 .. form of, 461, 462
 .. graduating sizes best, 462, 464
 .. importance of being angular, 461
 .. meaning of the word, 460, 574
 .. porous, 460, 461
 Air-slaking Portland cement, 63
 Aitchison, Professor, on ancient plastering, 230
 Akbar Mirza, Persian architect, designs by, 420
 Alabaster, 35
 Alberti on lime, 45
 Alburium, stucco, 101, 102
 Aleazar, plaster work at, 431
 Algiers, plaster work at, 424
 Alum for casting in jelly moulds, 331; fibrous plaster, 339; jelly moulds, 319; setting plaster, 331
 American composition, 566
 .. experiments in substitutes for ox hair, 51
 American experiments with sugar in cement and mortar, 48, 49
 .. modelling wax, 566
 .. patent plasters, 84
 Analysis and cost of labour and materials for plaster work, 559
 Analysis of hydraulic limes, 40
 .. Portland cement, 57
 Ancient concrete at Peru, 457; Rome, 456
 .. lath and plaster, 4
 .. lime plaster, 1
 .. plaster floors, 2
 moulding from lite, 2, 7,
 pavements, 2, 4
 statue of Apollo, 6; Bacchus, 3
 work at Hadrian's Villa, 230; Greece, 2, 230; the Pyramids, 1; Peru, 457; Pompeii, 5, 6, 230; Rome, 5, 230; the Temple of Apollo, 230
 work for damp walls, 4
 .. stucco, 2, 3, 4, 5, 6
 .. three-coat work, 1
 .. tools, 537
 Anderson's silicate cotton, 373
 Angelo's, Michael, use of the pouncing process, 237
 Angle brackets, to set out, 522
 .. degrees of, 521
 .. float, the, 538
 .. internal and external, 98, 100
 .. piece, Austrian, 446
 .. trowel, 546
 Anglo-Saxon plaster work, 14
 Annulets, position of, 528
 Antefix, terra-cotta, 452
 Appendix, 555
 Apprentices, good, 549
 .. importance of study by, 347
 .. London, 549
 .. seven years', 28
 .. the Plasterers' Company and, 548
 Apprenticeship, general system of, 551

- Apollo, ancient plaster statue of, 6
 Arabesques, Alhambra, 429
 " Damascus, 422, 424
 " created by the Moors, 428
 " method of setting out, 429
 Arabian architecture, 420
 " panel, 425
 Arch, O.G., to describe, 520
 " radius running mould, 513
 " to find the centre of an, 518
 " to set out a flat, 518, 519
 " " " moulded, 519
 " " " pointed, 519
 " " " semicircular, 519
 Arches over arches in façades, 203
 Architectural model making, 247
 Architecture, elements of, 522
 " orders of, 527
 Architraves, window, 208
 Archivolt mouldings, to run, 313
 " positions of, 533
 " proportions of, 533
 Arden lime, 39
 Arms, plasterers' coat of, 250
 Arnold's sand, 53
 Arnoldin, M., ornamental plasterer, 438
 Artificial marbles, 409
 " stone, 505
 " " strength of, 494
 Asbestic plaster, 78
 Aspdin, inventor of Portland cement, 55
 Astragal, use and position of the, 523
 Audley End, plaster work at, 16, 31
 Austrian Government, interest in plaster work, 447
 " plaster work, 446
 " Portland cement, 62
 " stucco, 446

BACCHUS, coloured stucco statue of, 3
 Bagutti, ornamental plasterer, 20
 Balcony fronts, 333, 334, 338, 339
 Baldwin, G., foreman plasterer, 238, 308
 Ball oil-pot, 280
 Ballard, Fr., on concrete paving, 477
 Balustrades, 534
 " cast, 274
 " distance between, 535
 " model making for, 271
 " plaster piece moulding, a, 272
 " the five orders of, 534
 Balustrades, cast, 204
 " constructing, 204, 205, 206
 " formed *in situ*, 204, 206
 " pierced work for, 207
 " ramped, 534
 " setting out, 203, 534, 535
 Barrow hydraulic plaster, 81
 Barry, E. M., judging effects of enrichments, 228
 Bassett's plaster, 77
 Bead, to describe, 526
 Bed-moulds, position of, 524
 " wax moulding, 255
 Beeswax, 247
 Belgian and British plaster work, 447, 448, 449
 " fibrous plaster, 447, 448
 " plaster work, 447
 " plasterers, 447, 448
 Beton aggloméré, 458, 459
 Bench slab moulds, 369
 Bénier fils, 396
 Bernasconi, ornamental plasterer, 141
 Bernhardt, S., tragedienne and modeller, 334
 Bibliothèque Nationale, plaster work at the, 439
 Bickley's patent blackboards, 83
 Bielefeld's papier-mâché, 393, 397
 Birmingham cement, 77
 Black finish, 83
 Blackboards, 78
 " American, Bickley's, Potter's, 83
 Block cornices, setting out, 199
 Bloomfield's plasters, 82
 Blubs in plaster, 270
 Bolling Hall, decorative plaster work at, 28
 Boston Manor House, plaster work at, 17, 32
 Bostwick metal lath, 87
 Bouchardon's casting wax, 252
 Brackets, cornice, 107
 " fibrous plaster cornices, 356
 " panelled ceilings, 126
 " Scotch, 108
 " spike and rope, 144
 " various, 575
 Branshill, plaster work at, 16
 Brandered ceilings, 120
 Brass, small tools, making, 545
 Brick dust, stucco, and terra-cotta, 8
 British and Belgian plaster work, 447, 448, 449
 " plaster work, excellence of, 449
 Briquettes, cement, 57
 " gauging for, 58
 " moulds for, 59
 " quantities of materials for, 57, 58
 " with and without sand, 58
 Brushed jelly moulds, 327
 Bulk of water absorbed by natural stone compared
 with artificial stone, 480
 Burness's patent non-slippery steps, 516

- Bushel boxes, sizes of, 558
- Busts *à la Belt*, 234
- .. casting, 326
 - .. jelly moulds for, 326
 - .. materials for, 235
 - .. modelling, 226, 232, 233
 - .. moulding, 326
 - .. moulding-piece for, 263, 264
 - .. Parian cement, 235
 - .. support for modelling, 233
 - .. waste moulding, 262, 263
- Butt joints for concrete mouldings, 207
- C**ALCIMETER for testing slurry, 56
- Calculation strength of concrete, notes for, 503, 504
- Calipers, 235, 538
- Camius concrete cement, 499
- Campo Vaccino, capital in the, 531
- Canvas and mortar, use of, 344
- .. cutting, 347
 - .. for fibrous plaster, 347
 - .. in Egyptian plaster work, 422
 - .. tags for fixing, 364
 - .. to keep clean, 348
- Carbonic acid as a factor in the setting of mortars, 45, 46, 94, 127
- Carnock Castle, plaster work at, 18
- "Carpere facilius est quam imitare," 233
- Carton-pierre, 395
- .. English and French, 395, 396, 397
 - .. Egyptian, 422
 - .. manufacture of, 395, 396
 - .. paper for, 396
- Cartouche from Lyons, 440
- .. Paris, 439
- Carved concrete, 508
- .. plaster, 442
- Cases, fibrous plaster, 337
- .. for busts, 326, 327
 - jelly moulds, 323, 324
 - straight and circular casts, 339
 - .. run, 363
 - .. use of lips in, 326
- Cast concrete, 504
- advantages of, 505
 - *in situ* work, advantages of, 508
 - stairs, 486
 - first use of, 486
 - use of iron for, 487
 - steps, 496
 - .. enrichment mitres, 308
- Casts from the antique for modelling, 226, 236
- Casts, paper, without moulds, 394
- Casting balcony fronts, 338
- .. balusters, 274
 - .. busts, 326
 - .. composition, 399
 - .. fibrous plaster. *See* Fibrous Plaster
 - .. gelatine for surgical purposes, 331, 332
 - .. in concrete. *See* Concrete
 - jelly moulds, 339
 - .. pediments *in situ*, 192, 197, 199, 392
 - .. plaster, 282
 - .. Portland cement, 284
 - .. wax, 251
 - .. white cements, 284
- Cavetto, to describe the, 524
- .. use and position of the, 523
- Ceiling at the Alhambra, 428; Astley Hall, 125; Audley End, 16, 31; Berlin, 442; Beeslack, 135; Bolling Hall, 28; Boston Manor House, 17, 32; Bradford, 138; Bramshill, 16, 30; Buckingham House, 22, 33; Careath, 134; Carnock, 18; Charlton, 16; Coleshill, 22, 33; Craigievar, 17, 31; Delhi, 434; Dublin, 22, 34, 139; the Ducal Palace, 10, 11; Edinburgh, 137; Florence, 11; Forfar, 140; Glasgow, 140; Great Yarmouth, 29; Greenwich Hospital, 34; Hanover Chapel, London, 23; Holyrood Palace, 19, 32, 137; Kedleston, 34; Liverpool, 137; Locksley House, 29; London, 18, 20; Losely, 16; Milton House, 21, 33; Moray House, 31; Persia, 426; Pindar's House, 29; Pompeii, 6; Quidenham Park, 31; Rome, 5, 437; Sevenoaks, 402; Sizergb Hall, 15; Slyfield, 242; St Martin's Church, London, 20, 32; St Mildred's Church, London, 10; Tivoli, London, 447; Trinity College, Perthshire, 142; Toddington, 140; Versailles, 21; Vienna, 447; Winton, 18, 31, 133
- Ceilings, ancient, 5, 6, 10, 11, 15; classic, 147; coffered, 126, 130; coved, 172, 437; decorative, 123, 124, 240; brackets for, 126; brandered, 120; fibrous plaster, 132; figured, 126; finishing, 131, 132; floating, 127; gauged, 127; geometric, 124; gesso, 402; Gothic, 140; gromed, 142; hard finish for, 131; historical, 123; joist lines on, 122; numerous pieces in, 429; plain plaster, 90-98; panelled, 126; panelling plain, 346; planting panels of, 130; renovating, 346; ribbed, 126; Roman, 120; running moulding for, 129; setting out panelled, 128; setting, 131; sketching old, 124; sound, 120; stucco, 125; white cement, 104-107
- Ceilings for circular rooms, 437
- Cement wash, 570
- Cementation, 515

- Cements, 55; adamant, 76; Basset's, 77; Birmingham, 77; first patent for, 55; Howe's, 75; hydraulic, 80; Keen's, 75; magnesia, 66; Martin's, 74; Medina, 74; metallic, 74; Parian, 75; Paris, 78; Portland, 55; Robinson's, 76; Roman, 73; Sheppey, 74; slag, 72; stone, 78; white, 104
 Cendree de Tournay mortar, 447
 Cennini, C., on fibrous plaster (1437), 344
 " gesso, 403
 " moulding from life, 7
 Centre flowers, 302; American, 303; German, 443; by parcels post, 346; cause of less use of, 302, 303; fibrous plaster, 350; French, 303; Indian, 434; large diameter of, 302; numerous pieces in, 302; making, 303; modelling of, 304; Persian, 427; plate, 302; prize, 306; sanitary, 304; use of oval, 303; various styles of, 302; ventilating, 304
 Centring, circular, 490
 " landing, 489
 " slab floor, 501
 " striking, 493
 Chalk lime, 40
 " oil, 323
 Chambers, Sir W., plaster work, 34
 Champneys, Basil, on ceiling decoration, 241
 Channels for concrete paving, 473, 478
 Charters granted to the plasterers by Henry VII., 27; 547; Charles II., 27
 Chasing wax moulds, 261
 Checking test for Portland cement, 60
 Chemical names of plasterers' materials, 559
 Chimney-piece plaster, 427, 429
 Chinese modelling *in situ*, 435
 " plaster work, 435
 " ventilation, 435
 Chloride of zinc for paper-mâché, 306
 Chunam, Indian mortar, 231, 432
 Cinque cento style, 576
 Circular casts, 257, 258
 Clark, T. and C., ornamental plasterers, 23, 34
 Clay beater, 250
 " cutter, 250
 " fences, 252, 255
 " for modelling, 234
 " model moulding, 254
 " modelling, 235
 " piece moulds, 262
 " squeezing, 262
 " terra-cotta, 451
 " water for moulding, 252
 Clearcole, to make, 571
 Coarse stuff, making, 43
 " sugar in, 50
 " testing of, 44
 Coffered ceilings, 130
 " brackets for, 130
 " concrete, 499
 " in Cairo, 223, 422
 " cornice " 423
 Coffers, setting out, 112, 113
 Collins, A. and W., ornamental plasterers, 23, 34
 Colours for architectural models, 248; busts, 235; distemper, 571, 572; fresco, 220, 223; Portland cement, 285, 484, 513; rough-cast, 558; scagliola, 414; sgraffito, 213, 215, 216; terra-cotta, 450; various tints, 569
 Coloured cements, laying, 484
 " façades in Austria, 446
 " plaster in Pompeii, 6
 " old, 6, 422, 423
 " setting, 99
 " stucco, 104
 " statue, 3
 Colouring concrete mosaic, 484
 " fresco, 220
 " gesso, 402
 " plaster, 235, 444, 446
 " Portland cement, 189, 285, 484, 513
 " rough stucco, 104
 " sgraffito, 213, 215, 216
 " stuccos, 436
 Colours on drawings, 559
 Columns and arches, setting out, 201
 " constructing plain diminished, 151, 152
 " diminishing, 148
 " diminished fluted, setting out, 148; trammel for, 149; floating rule for, 148; constructing by running, 152; machine, 153; casting, 154; collar method, 156; rim method, 155; best formed by hand, 155
 " diminution of, 532
 " heights of, 532
 " hollow, 390
 " over columns, 201, 203
 " parts of, 529
 " setting out flutes for, 151
 " three-quarter, 203
 Combined plaster and jelly moulds, 326, 341
 Comparative strength of grey lime and Portland cement mortars, 46
 Compass, Moorish, 429
 Composite archivolt mouldings, 533
 " capital, to make a, 269
 " column and entablature, 532
 " impost mouldings, 533

- Composite order, the, 532
- Composition, 397
- „ American, 566
 - „ Baldwin's improvements in, 398
 - „ casting, 399
 - „ durability of, 397
 - „ fixing, 307
 - „ for centre flowers, 307 : circular decorations, 398 : frames, 400
 - „ hand pressed, 400
 - „ Indian, 434
 - „ invention of, 397
 - „ London, 400
 - „ materials for, 399
 - „ modelling, 566
- Compositions, 393
- Compound moulding piece for jelly, 327
- „ pediment, setting out, 198
- Concavo-convex mouldings, 335
- „ surfaces, 177
- Concrete, aggregates for, 460, 461, 462, 463, 464
- „ ancient, 456, 457
 - „ and iron, 493
 - „ „ wood, 499
 - „ aqueducts, 456, 458
 - „ arches, 458
 - „ at the Paris Exhibition, 458
 - „ beams, 499
 - „ ceilings, cast finished face for, 491
 - „ chimney-pieces, 512
 - „ coffins, 515
 - „ Coignet, 458
 - „ coloured, 512
 - „ compared with stone, brick, &c., 480
 - „ compressed, 465
 - „ compression increases strength of, 464
 - „ compressive strength influenced by aggregates, 462
 - „ compressive strength of, 504
 - „ contraction in fine and rough, 472, 476
 - „ copings, 506
 - „ crushing strength of, 464, 465
 - „ domes, 457
 - „ dressings, 405
 - „ drying, 500
 - „ durability of, 456
 - „ evil effect of soft gauged, 465
 - „ expansion due to cement, 472
 - „ „ less in small bodies, 476
 - „ „ of fine and rough, 472
 - „ fine, 459
 - „ fire-resisting properties of, 68
 - „ fixing blocks, 514
 - „ floors, 497
- Concrete floors, ancient, 497
- „ „ and coffered ceilings, 499
 - „ „ at Rome, 457
 - „ „ Caminus concrete cement, 499
 - „ „ centring for, 501
 - „ „ chief objects of, 497
 - „ „ compressible chases for, 501
 - „ „ „ linings for, 503
 - „ „ construction of slab, 502
 - „ „ first patent for, 497
 - „ „ hollow, 503
 - „ „ incombustibility of, 501
 - „ „ increased strength by coving, 501, 502
 - „ „ joist, 498
 - „ „ live load for, 503
 - „ „ materials for, 502
 - „ „ notes for calculating strength of, 503
 - „ „ Phoenix, 497
 - „ „ resistance to damp, 501
 - „ „ safe load for, 502, 504
 - „ „ sanitary properties of, 501
 - „ „ slab, 501
 - „ „ tests of, 504
 - „ „ to counteract expansion of, 501
 - „ „ tubular, 497
 - „ fountains, 511
 - „ gains strength by compression, 473
 - „ garden edging, 512
 - „ gauging, 466
 - „ label mouldings, 506
 - „ lintels, 514
 - „ meaning of the word, 456
 - „ mosaic, 482
 - „ „ making, 483
 - „ „ materials for, 483, 484
 - „ „ pavements, 482, 484
 - „ „ polishing, 484
 - „ mouldings *in situ*, 508.
 - „ paving, 468
 - „ „ at the Health Exhibition, 475 : Inventions Exhibition, 469 : Rugby Railway Station, 476 : York Railway Station, 476
 - „ „ best laid in sections, 472
 - „ „ „ wearing, 471
 - „ „ claims of plasterers to lay, 460
 - „ „ compressive joints for, 476
 - „ „ counteracting expansion in, 476
 - „ „ cutting tool for, 477
 - „ „ dusting, 474
 - „ „ Eureka, 469
 - „ „ expansion joints, 476
 - „ „ falls, War Office rules as to, 478
 - „ „ fine aggregate best for, 470

- Concrete paving first introduced by Mr W. B. Wilkin-
son, 459
- frost, preventive for, 48, 466
- for breweries, 479; coach yards, 477;
dairies, 479; food factories, 479;
slaughter-houses, 477; stables,
477; washing yards, 477
- foundation for, 471
- grooved, 474
- groovers for, 541
- grooves for carrying off water, 475
- grooving, examples of, 475, 478
- grouting, 474
- hardening, 474, 481, 563
- indurating, 481
- jointers for, 541
- joints in, 476
- kerbs for, 473
- laid *in situ*, 468
- laying, 469, 473
- levels and falls for, 471
- metallic, 468
- non-slippery, 474
- overlap joints for, 503
- plasterers' work, 459
- preventing cracks in, 476
- protecting new, 469, 474
- quantities for, 470, 558
- quick setting solutions for, 469
- ramming, 473
- roughening, 474
- sand as an aggregate for, 462
- sanitary properties of, 477
- screeds and sections for, 472
- sections in, 476
- slabs, 480
- making and laying, 481
- sizes of, 480
- weights of, 558
- stamped, 475
- summary of, *in situ*, 480
- surface joints for, 476, 477
- temperature for, 474
- thickness of, 468
- trowelling, 473
- *versus* asphalt and other materials,
477
- Wilkes and Millar's, 469
- .. ramming of, 467
- .. reservoirs, 458
- .. roadways, 484
- .. roofs, 503
- .. sills, 506, 507
- .. sinks, 512
- Concrete stairs, 485
- at the Parmiter Schools, 487; South
Kensington Subway, 493; Tivoli,
London, 495
- between walls, 489
- cast landings, 487
- steps, 486, 496
- treads and risers, 496
- centring for, 489
- closed outer strings for, 497
- dimensions of, by figures, 488
- dowel holes for, 495
- Education Department on, 486
- falls for steps, 486
- fibrous concrete for, 495
- filling in, 491
- finishing of, 492
- formed *in situ*, 487
- framing for, 488, 489
- German tests for, 487
- hardening, 493
- importance of topping while green,
492
- *in situ*, 487
- iron in, 493
- jointed nosing moulds for, 488, 492
- landings in, 486
- London County Council Regulations,
486
- making good, 493
- non-slippery steps for, 493, 516
- nosings and risers, 488
- number of steps for, 485
- polished soffits for, 495
- protect while green, 493
- quantities for, 558
- ramming, 492
- self-supporting, 487
- setting out, 487, 488
- soffits of, 494
- size of steps, 486
- striking centring of, 493
- summary of, 496
- tests of steps, 487
- waterproof centring for, 490
- winders for, 485, 486
- .. string mouldings, 506
- .. strong rooms, 514
- .. tanks, 511
- .. tenacity of, 457
- .. tensile strength influenced by aggregates, 462
- .. the *Builder* on, 469
- *Engineer* on, 469
- .. trowelling for, 473

- Concrete vases, 279, 512
 .. walls, 456, 457, 514
 .. water for, 465, 467
 .. weights of, 557
 .. white finish in one operation for, 495
- Conventional and naturalistic styles, 227
- Copying mouldings, 536
- Corinthian archivolt mouldings, 533
 .. capitals, 296, 528, 531
 casting, 299
 making, 295, 298
 modelling, 298
 moulding, 299
 number of pieces in, 296
 .. cornice, constructing, 111
 setting out, 114
 .. entablature, setting out, 111
 .. impost mouldings, 533
- Cornices, brackets for, 107
 .. drawing, 290
 .. enrichments, to fix, 112, 113, 117, 118
 to principle, 111, 238
 .. fibrous plaster, 353
 .. gauging for, 110
 .. measurements of, 560
 .. running lime plaster, 108, 109, 110
 .. setting out coffers for, 112
 modillions for, 112
 .. white cement, 106
- Corona, use and position of the, 524
- Coved ceilings, 172
- Cracked plaster work, 120
- Cradle, 134, 538
- Cradling, ancient, 4
- Crane's, Walter, gesso work, 402
 .. recipe for gesso, 401
- Crushing strength of Portland cement concrete having various aggregates, 465
 .. weight of concrete compared with stone, brick, granite, &c., 480
- Cubitt, W., & Co.'s works, 238, 309, 398, 451, 455
- Cupola panels and moulding, 164
- Cusped arches, wonderful examples of the plasterer's craft, 428
- Cutting canvas, 347, 355
- Cyma, use and position of, 523
- Cyma-recta, to describe the, 525
- Cyma-reversa, .. 525
- D**ARBY, the, 539
 .. curious descriptions of, 553
 .. floating with a, 95
- Dartford Portland Cement Company, 72
- Datum-line, meaning of the term, 576
- Daubers and plasterers, distinction between, 24
- Daubing, 24
 .. with mud and wattles, 24
- Decorative ornament, dangers of superabundance of, 239
 first principles of, 239
 use and abuse of, 240
- Degrees of angles, 521
- Denston, ornamental plasterer, 20, 33
- Dentils, 112
- Depeter, 211
- Depretor, 211
- Designing decorative plaster work, 239
 .. friezes, 241, 243
 .. proportion, the principal point in, 240
 .. repeated part in, 240
 .. unity and appropriateness in, 228
- Devil-float, 96
- Diaper panelling at the Alhambra, 430
 working, 430
- Diapered external plaster work, 431
- Dimensions, squaring, 560
 circular, 562
 cubic, 561
 elliptical, 562
 irregular, 561
 superficial, 560
 triangular, 561
- Diminished columns, 148
 .. models, 294
 .. mouldings, 159, 164, 294
- Distemper, colours for, 572
 .. laying, 572
 .. making, 571
- Dodds, R., plasterer and mayor, 550
- "Dogga" mortar, 92
- Domes, 421
- Doric archivolt mouldings, 533
 .. capital, to make a, 300
 .. impost mouldings, 533
 .. order, the, 528
- Dormer windows, cement, 209
- Double diminished mouldings by false screed system, 160
 diminished rule system, 161
 top-rule system, 162
- Drapery, modelling, 226, 227
- Drawing a block cornice, 199: centre flower, 306, 307: compound open pediment, 198; Corinthian cornice, 114; Corinthian entablature, 111; cornice, 290; cupola with panels, 164; Doric portico, 104; truss, 290; Tuscan column and entablature, 520
 .. advantages of, 143, 224, 225, 293, 347

Drawing an order, 520
 .. art of, the twin sister of modelling, 224
 .. columns and arches, 201
 .. diminished columns, 148-151
 .. examples for plasterers, 529
 .. for Gothic work, 143
 terra-cotta, 452
 .. geometrical, 517
 .. good practice for plasterers, 529
 .. Ionic capitals, 300
 entablature, 300
 pedestals, 531
 volute, 301
 .. panels, 236, 237
 .. panelled ceilings, 133-139
 .. quoins, 201
 .. raking mouldings, 195
 .. to scale, importance of, 296, 300, 452
 .. triglyphs, 195
 Dubbing out, allowance for, 560
 Duplicating piece-moulds, 274
 Dutch-rush, uses of, 249, 268, 401

EFFECTS of salt and frost in mortars, 48
 Efflorescence in cements, 105, 107
 Egyptian plastering, 1
 Elements of architecture, 522
 Elizabethan plaster work, 29, 209
 Ellipses, setting out, 518
 Elliptical mouldings, 168
 Elsley, T., metal appliances, 191
 Employers and employees, good fellowship between, 551
 Employment for plasterers in frosty weather, 369
 English plasterers *versus* French plasterers, 345
 Entablature enrichments governed by modillions, 111
 .. position of, 529
 .. proportions of, 532
 .. setting out an Ionic, 300
 Enriched mouldings, ancient rules for modelling, 524
 .. plaster for wood staircases, 486
 Enrichments, cast mitres for, 308
 .. fixing, 112, 117
 .. jointed, 256, 327
 .. measurements of, 560
 .. mitring of, 117, 119
 .. stretching and shrinking, 118
 .. to principle, 111
 Eureka paving, 460, 469, 492, 558
 Expanded metal lathing, 86
 Expansion of Portland cement, 63
 Experiments as to wear of Portland cement, 471
 .. with cement and sugar for casting, 49

Experiments with fibre and hair, American, 51
 lime and sugar, American, 48;
 Compton's, 50; German, 48;
 Herzfeld's, 50; Indian, 49
 External decorative plaster work, 2, 9, 13, 16, 25, 27,
 29, 32, 421, 432, 441, 446, 447
 External slabs, 373

FACADES, Portland cement. *See* Portland Cement

Faija's tests of Portland cement, 57, 61
 Fascia, use and position of, 524
 Fence, meaning of the word, 576
 Fences, metal, 249
 .. permanent, 328, 329
 .. use of, for model making, 292
 jelly and wax moulds, 359
 wax moulds, 252, 261
 Fiamingo, modeller, 229
 Fibrous plaster, 343
 advantages in designing for, 347
 saving of time, 346
 ancient, 344
 and concrete, 333
 tow, 344, 367
 at Cairo, 344; Earl's Court, 345;
 the Naval Exhibition, 345; Opera
 House, Paris, 344; Paris Exhibi-
 tion, 344; South Kensington Exhi-
 bition, 344; World's Fair, Chicago,
 344
 balcony fronts, 333, 338
 Belgian, 447
 blocks, 379
 brackets, 356
 British history of, 343
 brushes, 538
 brushing firsts and seconds, 349
 canvas strips for, 349, 355, 358
 case, to make, 337
 casting, 348
 centre flower, 346, 350; en-
 richments, 360; enriched
 cornices, 356, 361; plain
 cornices, 354; perforated
 work in, 352
 compared with lime plaster, 133, 346
 cornices, 353, 357
 best lengths for, 353
 drying, 356
 fixing, 364
 mitre stops for, 353
 cutting canvas for, 347

- Fibrous plaster, decorative sheets, 366
 " " Desachy, introducer of, 343
 " " drying, 337, 338, 352
 " " fireproof, 365
 " " for architectural models, 248; casing,
 beams, and columns, 346; centre
 flowers, 346; enriching plain ceil-
 ings, 346; panelled ceilings, 346;
 renovating ceilings, 346; ship deco-
 rations, 345; stage properties, 344;
 stair cases, 495
 " " gauging for, 348
 " " hand rules for casting, 361
 " " hardening of, 378
 " " laths for, 348, 350, 351, 353, 354,
 375, 377
 " " " laid diagonally, 376
 " " making, 370
 " " materials, 347
 " " measurements, 365
 " " mitre and stop joints in, 353
 " " moulds for, 354, 356
 " " muslin plaster casts, 367
 " " nomenclature, 347, 349, 350
 " " painted before fixing, 346
 " " panelled ceilings, 346
 " " patent for, 343
 " " rapid plastering, 367
 " " resistance to fire, 366
 " " rims of casts in, 349, 355
 " " signboards, 378
 " " size water for, 348
 " " slabs, advantages of, 368
 " " " adopted by the London School
 Board, 368
 " " " bench mould for, 369
 " " " combination, 372
 " " " damp proof, 378
 " " " drying, 371
 " " " external, 373
 " " " fibro, 347, 371
 " " " finished-face, 374
 " " " " fixing, 377
 " " " " moulds for, 375
 " " " fireproof, 372
 " " " fresco, 378
 " " " gauging for, 368, 371
 " " " gesso, 377
 " " " grooved, 374
 " " " hardening, 378
 " " " Hitchin's inventions for, 367,
 372
 " " " keying surface of, 371, 372
 " " " litharge oil for, 378
- Fibrous plaster slabs, machine made, 367
 " " " Mack's, 374
 " " " makers' names on, 370
 " " " making, 370
 " " " " in frosty weather, 368
 " " " materials for, 347
 " " " metallic, 373
 " " " moulds for, 369
 " " " nails, quantities of, 556
 " " " perforated, 374
 " " " pugging, 378
 " " " rack for drying, 371, 372
 " " " reduced fire premiums for use
 of, 368
 " " " reed, 374
 " " " salamander, 372
 " " " setting, 372
 " " " sgraffito slabs, 377
 " " " sizes of, 368
 " " " superior to match boarding, 368
 " " " tallow pad for moulds, 370
 " " " templates, 169
 " " " unskilled labour bad for, 368
 " " " *versus* match boarding, 368
 " " " weights of, 556
 " " " Wilkes and Millar's, 65
 " " " wire drag for, 372
 " " " undercutting, 353
 " " " uses for, 344
- Figure modelling. *See* Modelling
 Fillet, use and position of, 523
 Fine concrete, 459
 Fineness of Portland cement, importance of, 62
 Fining Portland cement façades, 187
 Finished white face on concrete ceilings, 491
 Fireproof construction, compulsory, 333
 " fibrous plaster, 365
 " partitions, 333, 497
 Fish skin, use of, 249, 268
 Fixing enrichments, 117
 " panels, 130
 " stuff, 130
 Flaxman, modeller, 229
 Foreign competition in plaster work, 449
 " plaster work, 420
 Forsyth on the wretched plasterer from Como, 523
 Fortune, C., plasterer and mayor, 551
 Framed wax moulds, 350, 363
 Francis & Co.'s Portland cement, 72
 French architects and the use of plaster work, 430
 " carved plaster, 442
 " mitring, 441
 " plaster work, 438
 " plasterers and plastering, 440

- Fresco, antiquity of, 217
 .. art of, 217
 .. at Pompeii, 217; Tel-el-Amarna, 217
 .. by Masaccio, 217; Michael Angelo, 218;
 Raphael, 218
 .. Indian, 220
 .. materials for, 218
 .. panel, 222
 .. preparing walls for, 218
 .. secco, 220
- Fret enrichments, 300
- Frieze at Charlton, 16; Crewe Hall, 16; Hardwick
 Hall, 16; Mosque of En Nasireeyeh, 422;
 Mosque of Sultan Hassan, 422
 .. Persian, 428, 430
 .. position of, 530, 532
 .. swelled, to plaster, 107
 .. Turkish, 425
 .. with flower swag, 118
- Front wax moulds, to make, 254
- Frontispiece, description of, 250
- Frost repellents for plaster and cement works, 48
- Funnels for jelly moulds, to make, 324
 to use, 326, 337, 342
- Furred moulds, wax, 284
- G**ATCH plaster, 425
- Gauge, the, 540
 .. boards, 540
 .. pots, 240
 .. rules, 539
- Gauged work, 121
- Gauging, definition of the word, 577
- Gelatine, anti-mould acid for, 321
 .. British made, better than foreign, 318
 .. brushed gelatine moulds, 327
 .. casts, for surgical purposes, 331
 .. combined jelly and plaster moulds, 341
 .. compound moulding piece, 327
 .. covering capacity, 556
 .. dissolving, 320
 .. evils of painting, 330
 .. flexible, 319
 .. glycerine for, 319
 .. indurating solutions for, 319
 .. insoluble, 318
 .. interchangeable moulds, 340
 .. invention of, 317
 .. its uses for moulding, 317
 .. manufacture of, 318
 .. moulding, 317
 in, 325
 balcony fronts, 336
 busts, 326
- Gelatine moulding casts, 329
 clay models, 329
 trusses, 326
 white models, 329
 .. moulds, cases for, 323
 chalk oil for, 323
 compared with wax moulds, 318
 for casting Portland cement, 285, 319,
 331
 gum oil for, 322
 interchangeable, 340
 oiling, 322
 open, 329
 petroleum oil for, 223
 pouring on, 325
 preserving, 318
 seams and blubs in, 322
 seasoning originals for, 321
 oil, 321
 paraffin wax, 322
 shellac, 321
 straight, 330
 and circular, 339
 sugar wash for, 319
 use of channels for, 324
 vents for, 323, 337
 varnishes for, 330, 331
 without cases, 329
 .. pots, 320
 .. soft casts, 331
 .. spotty casts, 331
 .. stiffening rules for, 336, 342
 .. tests for, 318
- Gentlemen plasterers, 32
- Geometry, 517
- German experiments as to effect of frost on mortars, 48
 .. Government interest in plaster work, 442, 443
 .. mortar, 443, 444, 445
 .. oil for plaster moulds, 279
 .. plaster slabs, 443
 work, 442
 .. Portland cement, 62
 .. prizes for weather-proof plaster, 443
 .. tests for concrete stairs, 487
 .. white cement, 567
- Gesso, 400
 .. antiquity of, 400
 .. at Coire, 406; National Gallery, 400; West-
 minster Abbey, 401
 .. ceiling, 403
 .. Cennino Cennini on, 403
 .. colour, 402
 .. Crane's, Walter, ceiling in, 402
 recipe for, 401

- Gesso, duro, 402
 .. grosso, 402, 405
 .. materials for, 400, 401, 402
 .. method of working, 401
 .. modelling in, 400, 402
 .. polished, 405, 406
 .. Robinson's, G. T., method of, 401
 .. slabs, 377
 .. sottile, 402, 405
- Gilechrist's, A., stamps and rollers, 481, 541
- Girardon's wax for casting, 251
- Glass cubes and plaster decoration, 434
 .. ground for busts, 235
 concrete, 514
 plaster work, 434
 .. moulds, 374, 409, 416
 .. plate for modelling, 247
- Glossary, 574
- Glue moulds, 330, 403
- Glycerine a frost repellent in mortars, 48
 for concrete paving, 48
 .. composition, 568
 .. use of, for jelly moulds, 319
- Gothic arches, to describe, 520
 .. ceiling at Toddington, 140
 setting out, 143
 .. groined ceiling at Trinity College, 142
 ceilings, forming screeds with running moulds, 143
 intersection boards for, 143, 145, 146
 jack template for, 143, 146
 mitring ribs, 146
 pin moulds for, 143, 145
 running ribs without screeds, 143
 spike and rope brackets for, 144
 templates for, 143
 .. modellers, 141, 142
 .. mouldings, 523
 casting, 286
 materials for, 147
 .. plasterers, 141, 142
 .. plastering, 141, 142, 143, 144, 145, 146
 .. style, Ruskin on, 140
 Walpole's writings on, 140
 .. wheel window, to describe, 521
- Goujon, Jean, modeller and architect, 523
- Granite plaster, 81
- Granitic concrete quantities, 558
 .. finish, 418
 .. plaster quantities, 556
 .. plastering, 418
- Grant on Portland cement, 63
- Grecian capital, 529
 .. Doric column and entablature, 527
 .. Ionic column and entablature, 527
 .. mouldings, to describe, 525
 .. orders, the, 528
 .. stucco, method of using, 4
 .. temples, plaster pavement in, 2
- Greek honeysuckle ornaments, 452
- Groined ceilings, 142
- Grooved floating rule, 539
- Grounds, meaning of, 577
- Guggenheim on stucco, 103, 436
- Guilloche, mitres of, 309
- Gum oil, 322
- Gutta-percha moulds, 475
- H**AIR, 51
 .. dry and wet, 51
 .. ox, horse, and goats', 51
 .. quantities, 555
 .. substitutes, 51
 .. weights, 555
- Haired putty setting, 51
- Hand work compared with cast work, 422
 decorative plaster, 230
 examples of, 230, 231, 232
- Hanging running moulds, 314
- Hanwell, C., modeller, 343
- Harling, 210
- Hawk-boys, 550
 .. ancient, 10
 .. server, 546
- Heat, relative conductivity of various materials, 558
- Helical metal lathing, 88
- Hinged running moulds, 294
- Hobb's, P., concrete, 475
- Hobmans, A. C., pioneer of concrete mosaic, 483
- Hollow casts, 284, 390
- Hoogood, H., ornamental plasterer, 19
- Homan and Rodgers' concrete, 479, 497
- Howe's cement, 75
- Hugo, Victor, on plaster of Paris, 438
- Hydrate of lime, 42
- Hydraulic cements, 80
 .. plaster lime, 81
- I**MPERIAL Stone Company's, The, concrete slabs, 476, 481
- Impost mouldings, 533
- Impressed plaster work, 223, 230
 old, 25
- Indian centre pieces, 434

- Indian chunam, 432
 .. fresco, 220
 .. indurating plaster, 434
 .. marble plaster, 220
 .. modelling *in situ*, 435
 .. plaster work, 432
 .. plastering, 432, 435
 Indiarubber moulds, 332
In situ, meaning of the term, 577
 Intersection of square and splayed angle mouldings,
 315
 .. straight and circular mouldings, 172,
 174
 Ionic archivolt mouldings, 533
 .. capital, to make, 300
 .. impost mouldings, 533
 .. order, Grecian, 528
 Roman, 539
 .. pedestal, to set out, 531
 .. volute, to draw, 301
 Iron plaster, 83
 Irregular figures, reducing or enlarging, 289
 Italian lime, secret of making, 435, 436
 .. plaster casters, 550
 work, 435
 .. plasterers, past and present, 435
 .. Renaissance, 9, 11
 .. stucco, 437

JACK template for running Gothic ribs, 143
 Jackson, G., & Sons' plaster works, 343, 345, 395,
 397, 402, 448
 Jacobean plaster work, 30
 Jay, G. M., inventor of wedge mould, 505
 Jerry-builder and plaster work, 302, 550
 .. origin of the term, 577
 Jewish plaster work, 2
 "Jhilmil," metal lathing, 86
 Joggles for baluster piece moulds, 272
 cases, 324, 326, 327
 plaster piece moulds, 270
 wax moulds, 259, 263
 .. raised, 273
 .. run, 388
 .. wood, 261
 Joggler, the, 266
 Joints in enrichments, 327
 Jointing casts for jelly moulding piece, 327
 Joint lines on ceilings, 122
 Jones, Owen, first patron of fibrous plaster, 343
 Jones, T., fibrous slabs, 370
 Jubilee coffin, 515
 Jupiter Stator, capital at the temple of, 531

KANKAR lime, 432
 Keen's cement, 75
 casting, 284
 working, 104, 107
 Kettering iron furnaces, slag from, 464
 Keying, 96, 185, 467
 .. evils of non-, 51
 Keystone, making, 294
 .. in terra-cotta, 452
 Kufic frieze, 421, 422
 .. inscriptions, 428

LABOURERS' tools, 546
 .. wages, ancient, 25
 .. weight carried by, 542
 Lascelles' concrete, 458, 514
 Lath, plaster, float, and set, 90
 weight of, 558
 Lathing, 85
 .. ancient, 4
 .. Bostwick metal, 87
 .. expanded metal, 86
 .. Jhilmil metal, 86
 .. metal, 86
 sheet, 88
 .. plaster and wire, 88
 .. reed, 88
 .. slate, 88
 .. Vitruvius on, 4
 .. wire, 88
 Laths, covering capacity, 555
 .. fibrous plaster, 348
 .. hand and machine made, 85
 .. nails, quantities, 555
 weights, 555
 .. quantities, 85, 555
 Latto's canvas, 347
 Lead moulds, 230
 Levelling rule, 159, 539
 Lime, 38
 .. analysis of Scotch, 41
 .. and sugar, as used in Madras, 49
 .. Arden, 39
 .. circulating quantities, 556
 .. chalk, 40
 .. coarse stuff, covering quantities, 556
 testing, 90
 .. effects of carbolic acid in, 41
 .. Gillmore on, 64
 .. grinding, 43
 .. hydrate of, meaning of, 42
 .. hydraulic, 39
 .. importance of fine grinding, 40
 .. in the eye, 569

- Lime, Irish, 41
 „ kilns, 41
 „ Lias, 39
 „ M^oAra's process of grinding, 39
 „ measures, 556
 „ plastering quantities, 556
 „ pure, rendered hydraulic, 44
 „ putty, 50
 „ „ for mitring, 50
 „ Reid on, 64
 „ rich, 40
 „ Scotch, 40
 „ slaked for three months before using, 42
 „ slaking, 42
 „ „ amount of water required for, 42
 „ „ by absorption, 42
 „ „ „ immersion, 42
 „ „ „ sprinkling with water, 42
 „ „ quantities, 556
 „ Theil, 64
 „ Vicat on, 39
 „ Vitruvius on, 4
 „ water, 51
 „ weights, 566
- Limestone, chemical composition, 38
 „ where obtained, 38
- Limewash, 571
- Limewhite, covering capacity of, 556
- Litharge oil, 378
- Lombardi, A., stucco modeller, 9
- London County Council, law as to staircases, 486
- Looking-glass, use of, for modelling bust of self, 326
- Lundgren on Indian plastering, 435
- Lysistratus, first moulder of living faces, 264
- M**^oARA'S process of air-slaking Portland cement, 63
- M^oDonald, J., first worker in fibrous plaster, 343
- Maderna, C., modeller and architect, 523
- Magnesia cement, 66
 „ in mortars, 47
 „ „, Portland cement, 65
- Marble casts, 566
 „ mortar, 101
 „ plaster as used in Jeypore, 220
- Marezzo marble, 416
 „ „ making, 416
- Marmorite, 410
- Martin's cement, 74
 „ „ working of, 104, 107
- Martmoratum, 102
- Mastic, 53
 „ covering capacity, 556
 „ Greek, 568
- Mastic, Hamelein's, 54
 „ London, 54
 „ manipulation, 54
 „ Scotch, 53
- Materials, 35, 55
 „ adulterated, evil effects of, 549
 „ for modelled plaster, 245
 „ knowledge of, needful, 548
- Matrix, meaning of the word, 460, 577
- Measuring plaster work, 560
- Mediæval „ „ 25
- Medina cement, 74
- Metal fences, use of, 249
 „ moulds, 274, 393, 395
- Metopes, position and use of, 529
 „ setting out, 195
- Michael Angelo, sculptor, 523
 „ on stucco modelling, 9
 „ and use of pouncing process, 237
 „ work at St Peter's, Rome, 523
- Middleton, Professor, on concrete, 457
- Mihrab, plaster work in a, 424
- Millar's, R., collection of tools, 546
- Minio, a female stucco worker, 15
- Minocci, P., stucco worker in Florence, 11
- Mitre and stop joints, 353
- Mitring, 115
 „ enrichments, 117, 308
 „ „ good and bad work, 238
 „ „ hand worked, 239
 „ „ modelled, 239
 „ „ setting out in shop, 239
 „ „ stretchers and shrinkers, 238
 „ guilloches, 309
 „ mould, 116
 „ ornamental angles, 177
 „ Portland cement mouldings, 187
 „ rib intersections, 146
 „ tools, 542
- Model making, architectural, 247
 „ „ balusters, 271
 „ „ Composite capital, 290
 „ „ Corinthian „ 295
 „ „ enrichments, 255, 308
 „ „ example for plasterers, 529
 „ „ good practice for plasterers, 530, 531
 „ „ Ionic capital, 300
 „ „ keystone, 294
 „ „ terra-cotta, 452
 „ „ truss, 290
 „ „ use of small scale, 235
- Modelled concrete, example of, 511
 „ plaster, 240, 241, 242, 243, 244
 „ „ first use of, in France, 438

- Modelled plaster, materia's for, 245
 .. stucco, 3, 5, 8, 9, 10, 11, 12
- Modellers' blouse, a garb of honour, 232
 .. diplomatic correspondence, relating to, 13
 .. Garland, T., the father of modern, 233
- Modelling, 224
 .. *à la* Belt, 234
 .. antiquity of, 224
 .. a knowledge of mythology useful for, 226
 .. Atchison, Professor, on, 230
 .. Art schools and, 225, 230
 .. artistic effects of, spoilt by smoothing, 244
 .. busts, 226, 235
 .. casts from the antique, useful for, 226, 236
 nature, uses of, 236
 .. centre flowers, 304
 .. clay for, 234
 .. cobbling to save expense of, 228
 .. combined, and stamp work, 230
 .. comparative cost of cast and hand work, 228, 230
 .. composition, 566
 .. Corinthian capital, 298
 .. designing, 239, 240, 241
 .. drawing essential for, 224, 235
 .. educates the hand and eye, 235
 .. enrichments, 238
 .. expresses ideas better than drawing, 235
 .. false economy on weak foundations, 245
 .. flat and high relief, 240, 243
 .. figure, 225
 a knowledge of allegorical subjects essential for, 226
 advantage of, 226
 casts from the antique for, 225
 copying from nature for, 225
 half figures, 237
 in Austrian façades, 446
 cement, 246
 life models for original subjects, 226
 proportions of the human figure, 225
 terra cotta, 452
 use of anatomy for, 225
 .. for plasterers, 530
 .. frieze and ceiling decoration, 241
 .. Greek and Roman foliage, 297
 .. hand work, 230
 .. imitation in design, an error, 227
 .. importance of drawing for, 224
 .. in cement as easy as in clay, 229
 fine concrete, 510
 plaster, 4, 235
 stucco, *See* Stucco
 tow, 247
- Modelling in wax, 246
 .. *in situ*, 229, 244
 advantages of, 178, 201
 an impetus to the art of, 229
 art and uses of, 229
 economical and effective, 178, 201, 209
 plaster, 425
 .. judging the effects of, 228
 .. looking-glass, use of, for, 233, 236
 .. medallions in wax, 246
 .. method of, 235
 .. naturalistic and conventional styles, 227
 .. panels for copying, 236
 .. pate plastique, 235
 .. pilaster panel for copying, 237
 .. plaster as a ground for, 237
 and tow for scenic work, 344
 .. plastilina for, 234
 .. portraiture, 226
 .. prizes for, 548
 .. proportion important in design, 240, 241
 .. repetition in design, 240
 .. retention of models detrimental to the art of, 228
 .. shop, 232, 250
 and building work and, 229
 .. study of anatomy, useful for figure, 225
 .. supposed origin of, 577
 .. textures in clay, 227, 236, 243
 .. the acanthus leaf, 298
 best method of expressing form, 224
 modeller's art, 228
 principles of, 224
 study of the human figure imperative for, 224, 237
 twin sister of drawing, 224
 .. tools, 233, 234
 .. truss enrichments, 293
 .. unity and appropriateness in design for, 228
 .. use of copying for, 235, 237
 .. *versus* cast work, 178
 .. wax, 247
 .. Webb, Stephen, on modelling for plaster work, 243
 .. window heads, 209
- Modillions, 199
 .. casting, 113
 .. drawing of, 290
 .. fixing, 113, 190
 .. govern the enrichments, 111
 .. right, left, and centre, 196, 197
 .. setting out, 112

- Modillions, to principle in façades, 203
 Module, parts of a, 529
 Moulds for composition, 398
 concrete copings, 507
 *in situ*, 408
 cornices *in situ*, 408
 nosing of steps, 488
 sills, 507
 step, 488
 string mouldings, 506, 508
 finished face slabs, 375
 turning columns, 412
 .. interchangeable, 340
 .. reverse, 380
 .. rims of, 348
 Moulding box, use of, 255
 .. bust, 326
 .. casts, 329
 .. centre flowers, 306
 .. clay models, 329
 .. Corinthian capital, 299
 .. enrichments for fibrous plaster, 356
 .. for terra-cotta, 453
 .. from life, 264
 ancient method of, 2, 7
 .. hammer, 266
 .. in gelatine, 325
 paper, 394
 plaster, 265
 sulphur, 398
 wax, 252
 .. models without a ground, 341
 .. old mouldings, 536
 .. plaques, 261
 .. plaster piece. *See* Piece Moulding
 .. white models, 329
 Moulding piece for balconies, 334, 336
 dentils, 359
 egg enrichments, 256
 front and back, 260
 fibrous plaster enrichments, 359,
 362, 363, 364
 perforated coves, 260
 soffit, 254
 sunk panels, 363
 compound, 327
 meaning of the term, 578
 seasoning, 321
 stock, 329
 without joggles, 362
 Mouldings, the regular, 523
 .. to copy, 536
 .. use of drip members, 509
 Mortar, 43
 Mortar and beer, eggs, milk, sugar, &c., 102, 432 :
 brick dust, 44 ; bullocks' blood, 102 ; fibre,
 102 ; marble dust, 101, 103 ; pitch, 102 ;
 rice, &c., 103 ; rye dough, 103 ; sugar, 48,
 40, 50 ; unctuous earth, 103 ; urine, 103 ;
 wax, 102
 .. Chinese, 435
 .. " Dogga," 92
 .. effects of salt and frost in, 48
 .. German, 443, 444, 445
 .. hardening of, 45, 94, 127
 .. importance of quality of lime in, 45
 .. Indian, 432
 .. magnesia, 47
 .. mills, 43
 .. old, 45, 102
 .. proportions of materials for, 43
 .. proverbs on old, 45
 .. quantities from various limes, 557
 .. Roman, 49
 .. salt water in, 48
 .. Westmacott's, 64
 Moorish plaster work, 428
 Mosaic, 482
 .. concrete, 482
 laid *in situ*, 483
 polishing, 484
 Muffled moulds, 316
 for panel mouldings, 130
 Mural Decorations Company's patent plaster, 406
 Muslin plaster casts, 367
 Mutules, position and use of, 529
 .. setting out, 196
 NAIL-FLOAT, 96
 Name panels in decoration, 340
 Name plates for slab moulds, 481
 Naturalistic and conventional styles, 227
 Nelson's gelatine, 331
 Neeves', P. le. recipe for stucco, 14
 Nibby, Antonio, on lime concrete, 456
 Niches, 178
 .. crowns of, 180
 .. fibrous plaster, 180
 .. of Fame, the plasterers', 34
 .. run, 178
 .. to set and construct an Ionic, 197
 Nonsuch, plaster work at, 13, 26, 27
 .. the plasterers' pride and pleasure, 27
 OCTAGON, to form an, 518
 Ogee, use and position of the, 523, 524
 Oil seasoning originals, 321
 Oiling jelly moulds, 322

- Oiling plaster moulds, 270
 .. wax moulds, 280
 .. wood moulds, 491
 Old lime putty for fresco plaster, 218
Opus albarium stucco, 101
 Orders of architecture, 527
 Ornamental pierced work, 207
 .. plaster, its use and treatment, 239
 .. sanitary, durable, and fire resisting, 239
 .. stucco work, produced by a patent process, 223
 Ostell, Van, plaster work at the Louvre, 438
 Oval, to form an, from circles, 518
 Ovolo, to describe the, 524
 .. use and position of the, 523
- PAINTS, 573**
 Panel mouldings, 129
 Panelled beams, 166
 .. ceilings, 126
 .. and concrete floors, 499
 .. Gothic, 140
 .. in the classic style of, 147
 .. lathing, floating, setting out, and finishing in limes and cements, 126, 128, 133, 134, 135, 136
 .. pendentive, 428
 .. planted, 130
 .. Portland cement for, 132
 .. working plans of, 133, 134, 135, 138
 .. coves, 158, 172-177
 .. cupolas, 164
 .. fascia, 177
 .. soffits, 165, 362
 Paper as a substitute for hair, 435
 .. casts without moulds, 394
 Papier-mâché manufacture, 393
 .. moulds for, 394
 .. stage properties, 393
 Papworth, J., ornamental plasterer, 23, 34
 Paraffin, uses of, 319, 322, 330
 Pargetting, 28
 Pargettors, commonly called "plasterers," 14
 Parging and plastering, 15, 18
 Parian cement, 75
 .. covering capacity, 555
 .. finish and Portland cement, 105
 .. finishing in, 106
 .. floating ceilings, 105
 .. for repairs, 121
 .. gauging, 105
 .. running cornices in, 106
 Parian cement solution, 121
 .. trowelling, 107
 .. weights, 555
 .. work, 104, 107
 Paris cement, 78
 Partitions, concrete, for balcony fronts, 333
 .. wattles and plaster, 420
 Pasley, General, on hydraulic cements, 80
 Pâte coulante, 397
 .. plastique, 235
 Patere, casting and fixing, 113
 .. designs of, 437
 Pavements, ancient plaster, 2, 4
 Pedestals for balustrades, 203, 535
 .. formed *in situ*, 206
 .. making models of, 198
 .. Ionic column, to set out, 531
 Pediments, 191
 .. compound open, 198
 .. inverted circular, 197
 .. pitch of, 192, 195
 .. to cast *in situ*, 191, 197
 .. construct in cement, 191, 197
 Pendant patera, to make, 362
 .. use of, 174
 Pendentive arches, 428
 .. ceilings, 428
 .. working, 428-430
 Pergolesi's design for wall decoration, 22
 Persian method of working domed ceilings, 427
 .. plaster work, 424
 .. at the Paris Exhibition, 427
 .. plasterers, 426
 Peru, ancient concrete and plaster in, 457
 Petrie's, Dr. discoveries of ancient plaster work, 1, 344
 Petrura plaster, 82
 Piece moulding a baluster, 272
 .. a bedding piece in, 340
 .. a hand, 264
 .. a modillion, 268
 .. a vase, 274
 .. as in Venice, 9
 .. cases for, 267, 271, 274
 .. clay models, 267
 .. closing pieces for, 267, 277
 .. combined with jelly, 341
 .. duplicating, 274
 .. fences for, 269
 .. figures for, 270, 273, 275, 278
 .. for carton-pierre, 267
 .. from life, 264
 .. ancient method, 7
 .. in plaster, 265
 .. joints in, 268

- Piece moulding joints, best places for, 277
 cutting, 269
 flush, 276, 278
 for jelly, 326, 341
 sunk, 267, 276
 laying plaster for, 271
 links for, 278
 Lysistratus supposed inventor of, 264
 "on the round," 272, 274
 plaster for, 266
 rim pieces for, 275
 seasoning models for, 266
 shoulder piece for, 270, 278
 size of pieces in, 267
 use of dots in, 271
 thickness rules, 271
 wedge pieces in, 278
 wire eyes for, 268, 277
 works in, 265
 in clay, 262
 plaster and wax, 256
 wax, 261
 Verochin, A., pioneer of, 9
 .. moulds, running, 380-383
- Pierino del Vagu, hawk boy and modeller, 10
- Pilasters, diminished, 158
 .. proportions of, 533
 .. window, 208
- Plaster, adhesive strength of, 38
 .. American, 84
 .. ancient use of, 7
 .. and tow, uses of, 367
 .. Asbestic, 78
 .. baked, 37
 .. Benvenuto Cellini's choice of, 38
 .. boiled, 36
 .. Bristol, 38
 .. British and American terms for, 35
 .. Cafferata's, 38
 .. casts, cause of blubs in, 283
 hardening, 563
 hollow, 284
 impervious, 568
 of natural objects, 567
 polishing, 564
 washable, 565
 waterproof, 568
 whitened by sunshine, 283
 .. casting, 282
 antiquity of, 282
 in wax moulds, 283
 .. chimney-piece, 429
 .. compressive strength of, 38
 .. designed by Dame Nature, 265
- Plaster, difference between stucco and, 102
 .. Egyptian, 1
 .. etymology of the word, 35
 .. fire resistance of, 443
 .. first use of, in England, 14
 .. floors, 498
 .. foreign names for, 578
 .. French, 38
 .. gauging, 281
 .. Greek, 35
 .. hand-made, 35
 .. hideous use of, 425
 .. Hotel de Plâtres, 38
 .. Howe's pink, 38
 .. "killed stuff," 281
 .. linen and glue, old use of, 403
 .. manufacture, 36
 .. moulds, water-seasoned, 285
 .. moulding from life, 264
 .. old price of, 25
 .. of Paris, 35
 .. piece moulding. *See* Piece Moulding
 .. quantity for gauging, 281
 .. quick and slow setting, 37
 gauged *versus* slow gauged, 281
 .. slabs at Tel-el-Amarna, 283
 .. soft gauged *versus* stiff gauged, 281
 .. statuary marble, 566
 .. strong, 284
 .. testing, 37
 .. to set quick, 565; to set slow, 565
 .. use for old, 282
 .. use of, for moulding, 265
 in Paris, 440
 measures for gauging, 281
 .. waste moulding, 262
 .. weights of, 555
- Plasterers, Acts relating to, 24, 27, 30
 .. ancient, 1-32
 .. and architects, 523
 civic honours, 550
 daubers, distinction between, 24
 jerry workers, 27
 M.P.'s, 551
 piecework, 549
 whitewashing, 550
 .. appliances, 537, 555
 .. apprentices, 28, 549
 .. arms, 547
 .. benefits of master, 549
 .. census of, 551
 .. certificates of competency, 105, 551
 .. charter, 547
 .. Company, the, 547

- Plasterers, craft, the, 548
- .. definition of, 578
 - .. El Dorado, 550
 - .. emblem, 250
 - .. feast days, 25
 - .. "field rangers" and, 550
 - .. fined for plastering, 548
 - .. fines for bad materials, 28
 - .. " " workmanship, 28
 - .. Hall, 548
 - .. hawk boys, 550
 - .. London, 548, 550
 - .. master, 549
 - agreement, fourteenth century, 25
 - craftsmen, 27
 - .. memoranda, 555
 - .. motto, 250, 548
 - .. mud (1189), 24
 - .. oval, 170
 - .. pioneers of concrete paving, 459
 - .. plant, 537, 546; banker, 538; brushes, 538; brooms, 538; calipers and compasses, 538; cradle, 538; drags, 539; files and rasps, 538; floats and rules, 538; gauges, 540; gauge-boards and stands, 540; groovers and rollers, 540; hammers, 540; hods, 541; iron floats, 546, 549; laries and rakes, 542, 546; palls, 543, 546; planes, 544; punching sieve, 545; putty box, 546; riddle rest, 545; saws, 544; scaffolds, 544; scaffold trestle, 546; scaffold ship; head, 546; scratches, 544; screens, 544; sieves and riddles, 545; slack box, 546; squares, 545; radius rods, 543; templates, 545; tubs, 546
 - .. prizes for, 548, 552
 - .. provincial master, 549
 - .. quantities, 555
 - .. riots, 548
 - .. Shakespeare on, 28
 - .. shop, 249
 - .. sweating and, 550
 - .. technical training for, 551
 - .. technique of plastering, 105
 - .. tools, 537; brushes, 537; brooms, 537; calipers, 537; chalk-line, 537; compasses, 537; drags, 537; gouges and chisels, 540; hammers, 541; hand-floats, 540; hawk, 541; home-made small tools, 547; joint rules, 542; knives, 542; large collection of, 546; level, 542; mitring tools, 542; pincers, 542; scratch tools, 543; small tools, 544; squares, 545; tool box, 545; trowels, 545; to clean, 546
- Plasterers *versus* bricklayers, 28, 548
- carvers, 347
 - masons, 28
 - non-plasterers, 459
 - painters, 16, 30, 548
 - .. wages in the thirteenth, fourteenth, and sixteenth centuries, 24-27
 - high, of, 550
 - .. with two trades, 549
- Plastering, art of, 89
- .. lime, 89
 - first-coating, rendering, scratching, keying, 90, 91
 - floating, plumbing walls, screeding, flanking, common floating, floating with a darby, keying, devilling, and scouring coarse stuff, 92-96
 - setting, laying, scouring, trowelling, and brushing, setting stuff, coloured, common, skimming, and gauged setting, 97-100
 - angles, 100
 - cornices, running, 108
 - fixing enrichments, 117
 - gauged putty set, 100
 - mitring, 115
 - enrichments, 117
 - pugging, 119
 - quantities, 556
 - Shakespeare on, 28
 - skirtings, 100
 - stucco, 101-104
 - two-coat and three-coat work, 90, 101
- Plaster-work, ancient, 1, 2, 3, 4, 5, 6, 24, 282, 420, 457
- .. British and French systems, 441
 - .. colour indications for, 559
 - .. combined with stone and brick work, 431
 - .. cracked work, 120
 - .. damp walls, ancient method of, 4
 - .. dimension book abbreviations, 560
 - .. evil effect of scamped, 549
 - unskilled labour, 549-551
 - .. foreign competition, 447, 449
 - names for, 578
 - .. historical, Anglo-Saxon, 14; antiquity of, 1, 24; Egyptian, 1, 2; Elizabethan, 15, 29; Georgian period, 21; Greek, 2, 4; Irish, 22, 34; Italian Renaissance, 7, 9, 11; Jacobean, 17; Jewish, 2; mediæval, 25; Norman, 14; primitive, 24; Roman, 5-10; Scottish, 17, 19, 21, 31; Stuart dynasty, 19; sixteenth, seventeenth, and eighteenth centuries, 27, 31, 32, 33

- Plaster-work, insanitary, 95
 „ machine for, 548
 „ measuring, 560
 „ meaning of the term, 578
 „ mud, 102
 „ natural covering of walls and ceilings, 240
 „ repairing old, 120
 „ sparkling effects, 432-434
 „ universal lining for walls, 89
 „ unremunerative, 551
 „ value of labour and materials, Table, 559
 „ with glittering effects, 434
- Plastic literature, 551
 „ materials, weights of, Table, 558
 „ meaning of the word, 578
 „ terms, 89
- Plastalina, 234
 Plastography, 578
 Pliny on mortar, 43
 „ moulding from life, 264
 „ old lime, 42, 50
 „ slaking lime, 5
 „ stucco, 101
- Polisher for concrete mosaic, 484
 Polishing concrete mosaic, 484
 „ marble plaster, 221
 „ plaster work, 432, 433
 „ scagliola, 115
- Porosity of materials, 557
 Portico, setting out a, 194
 Portland and Sheppey cement façades, 182
 „ cement, 55
 „ „ acid-proof, 568
 „ „ adhesion of, 63, 65
 „ „ adulteration of, 57, 71
 „ „ aëration of, 65
 „ „ affinity for moisture, 465
 „ „ aggregates for, 281
 „ „ air-slaking, 63
 „ „ analysis of, Table, 57
 „ „ and lime, comparative strengths of,
 Table of, 46
 „ „ „ sand, comparative strength of,
 Table, 557
 „ „ „ „ covering capacity of, 557
 „ „ „ „ wear of, 471
 „ „ „ sea-water, 465
 „ „ „ sugar, 48
 „ „ Austrian, 62
 „ „ Bamber's tests for fineness of, 73
 „ „ briquettes, 59
 „ „ casting, 284
 „ „ „ dry process, 286
 „ „ „ hydraulic power for, 289
- Portland cement casting, sugar for jelly moulds, 49
 „ „ „ water seasoned moulds for,
 285
 „ „ „ casts, cause of fire cracks in, 285
 „ „ „ porous moulds, cause of sur-
 face cracks in, 490
 „ „ „ pressed work, 286
 „ „ cold atmosphere retards setting, 474
 „ „ chemistry of setting, 68
 „ „ chief qualities of, 57
 „ „ coarse residue valueless, 62
 „ „ colour, solution for, 513
 „ „ coloured, 285
 „ „ compressive strength of, 61
 „ „ contraction of, 63
 „ „ effects of age on, 66
 „ „ „ salt in, 48
 „ „ „ soft gauging, 461
 „ „ example of tenacity of, 461
 „ „ expansion of, 63
 „ „ façades, 181
 „ „ „ and brick work, 182
 „ „ „ balustrades for, 204
 „ „ „ best for resisting damp, 183
 „ „ „ block cornices and quoins
 for, 199, 201
 „ „ „ columns and arches in, 201
 „ „ „ coloured, 189
 „ „ „ combined with stone and
 brick work, 182
 „ „ „ compared with stone and
 other materials, 182, 183
 „ „ „ compound open pediment
 for, 199
 „ „ „ depeter for, 211
 „ „ „ desirability of, 183
 „ „ „ Doric porticos for, 194
 „ „ „ fixing modillions for, 199
 „ „ „ „ points in, 190
 „ „ „ for casing old stone, 183
 „ „ „ future use of, 184
 „ „ „ gateways for, 201
 „ „ „ gauging for, 184
 „ „ „ importance of keying and
 wetting, 184
 „ „ „ Ionic niches for, 196
 „ „ „ materials for, 184
 „ „ „ methods of working, 184 ;
 permanent screed process,
 184 ; plaster screed pro-
 cess, 189 ; fining, 187 ;
 running mouldings, 185
 „ „ „ modelling *in situ* economical
 for, 178, 201, 209

Index.

- Portland cement l. articles: 160 examples of, 181, 183
 pedestals for, 198
 pediments for, 191, 197
 preserving and colouring, 190
 rapidly repaired, 183, 205
 rustication for, 201
 sand for fining, 188
 scaling, cause of, 183
 sgraffito work for, 189
 superior to soft stone, 183
 three-quarter column for, 204
 trowelled surfaces for, 189
 vermiculated work for, 200
 windows for, 207, 208, 209
 fine grinding of, 62, 70
 relative cost of, 70
 strongest and cheapest, 73
 fineness, importance of, 60, 70
 fire resisting properties of, 67
 German, 62
 hardening of, 69, 71
 increase of strength, Table of, 67
 influence of light on, 67
 initial set of, 69, 497
 lime mortar, 444, 446
 putty, 514
 magnesia in, 65
 manufacture of, 55
 relative fineness and cost of, 70
 setting, time of, 68
 accelerating, 66, 288
 sieving, 58
 specific gravity of, 57
 specifications for, 69
 tenacity of, 461
 testing of, 59
 by boiling, 60; checking
 test, 60; colour, 57, 59;
 fineness of, 62, 71;
 needle, 60; sand, 61;
 soundness, 62; tensile
 strength, 60, 61; trans-
 verse strength of, 62;
 weight, 56, 57, 59
 without a machine, 62
 to set quick, 66
 trade in, 72
 weights, 557
 white, 484
 work value of, 559
 Potter, T., on Portland cement work, 280, 508
 Pouncing for reproducing designs, 222, 237, 293
 .. Michael Angelo's use of, 237
 .. Raphael's use of, 237
 Practical geometry, 517
 Preserving plastered façades, 190
 Pressed cement work, 286
 .. screeds, 158
 Prior, E. S., on modelled plaster, 240
 Primary cause of decay in stucco work, 45
 Primaticcio, modeller, 12, 101
 Primitive mode of plastering, 24
 Prize centre flower, 306
 .. cornice, 312
 Prizes given by the Plasterers' Company, 548
 Profile, 524
 Proscenium panel, to make a fibrous plaster, 341
 Pugging, 119, 378, 497
 Puzzolana, 44

QUANTITIES of materials (in various gauges)
 required to make one cubic yard of gauged Port-
 land cement and sand, Table, 557
 Quantity of mortar produced from one imperial bushel
 of various limes and cements, Table, 557
 Quarter round, to describe the, 524
 Quick-setting solutions for concrete, 469
 Quoins, setting out, 199, 201

RADIUS of segment found by figures, 521
 Radius pin, use of, 134
 Radius rod, the, 543
 .. mould, uses of, 175
 .. uses of, 176
 Raking cyma-recta, to describe, 192
 .. modillions, setting out, 194
 .. mouldings, setting out, 192, 193
 .. returned cornice, to describe, 193
 Raphael and stucco work, 9
 Rapid plastering, 367
 Recipes, 563
 Rectangular quatrefoil, to describe, 521
 Reducing or enlarging irregular figures, 289
 Reduction in bulk of materials, 557
 Reeds in plaster work, 4, 28, 374, 379, 498
 "Reekie" for cement, 469
 Relative cost of cast and *in situ* modelled work, 178,
 201, 209
 Renovating old ceilings, 346
 Replicas of works of art in fine concrete, 505
 Restall's adamantine plaster quantities, 556
 Reverse casting cornice mould, 382
 .. moulding, 380
 .. moulds for cornices, 382, 383, 384
 lengths of, 353
 diminished fluted columns, 386
 fibrous plaster cornices, 354, 356
 ovals, 171

- Reverse moulds for over-doors, 390
 panel mouldings, 384
 pedestals, 198
 pediments, 390
 pilasters, 386
 plain caps, 385
 columns, 389
 rib mouldings, 354, 385
 templates, 169
 .. moulds, wax loose piece for, 363
 .. running mould, 384
 loose plate for, 380-382
 setting out of, 381
 loose piece for, 382, 384
- Rims of casts, 349, 351, 578
 .. moulds, 348, 350, 552, 578
- Roadways, concrete, 484
- Robbia, Luca della, modeller, 229
- Robinson, G. T., on ancient plaster work, 1-23
 gesso, 401
 sgraffito, 212
 stucco work by, 230
- Robinson's cement, 76
 tensile strength of, 76
- Roman cement, covering capacity of, 557
 manufacture of, 73
 weights of, 557
 .. ceilings, 126
 .. concrete, 456
 .. Corinthian entablature, 532
 .. Doric entablature, 527, 529
 .. Ionic entablature, 527, 530
 .. law relating to the age of lime, 43
 .. method of drying plaster on walls, 102
 reed lathing on wood, 102
 .. mortar, 101
 and Portland cement, 45
 .. mouldings, to describe, 524
 .. orders, 529
- Rose, J., ornamental plasterer, 23, 34
- Rough-cast, 210
 .. quantities, 558
- Run-down, meaning of the term, 578
- Run-joggles, 388
- Run plaster cases, 363
- Running arch panels, 313: beams, 314: circular work, 172, 174: cornices, 108: coves, 174, 177: crown of coves, 314: cupolas, 165: diagonals, 174, 177
 .. diminished columns, 152
 mouldings, 160
 .. double diminished mouldings, 161, 163
 .. elliptical arches, 166
- Running English and Scotch methods, 108
 .. Gothic ribs, 144, 146: niches, 178: ovals, 166, 168, 170: panels, 129: pediments, 191, 197: piece moulds, 382: plaster cases, 363
 .. Portland cement mouldings, 185
 .. quoins, 200, 209
 .. raking mouldings, 191, 194
 .. reverse casting moulds, 384, 390
 .. skirtings, 100: soffits of arches, 168: waste moulds, 286: white cements, 106: window heads, 208
- Running-moulds, 309
 .. half-rib pin-mould, 146
 .. hanging, 314: hinged, 294
 .. making, 310: the various parts of, 311: English *versus* Scotch, 310
 .. muffled, 316: notes on, 316: pin, 143, 146: radius, 313: reverse, 381: twin-slipped, 313: with a ball nib, 177: with a bull-nose nib, 177
 .. for circular surfaces, 173-177
 concavo-convex mouldings, 335
 surfaces, 177
 concrete stairs, 492
 cornices, 108, 312
 diminished fluted columns, 152
 double diminished mouldings, 162
 elliptical arch mouldings, 169
 Gothic ribs, 143-146
 model making, 293
 niches, 179
 oval mouldings, 167
 pediments, 191-197
 piece moulds, 381, 383
 plaster cases, 363
 raking mouldings, 193
 skirting, 101
 sledge-slipped, 177
 square and splayed angles, 315
 white cements, 106
- Russian plaster work, 449
- Rustication, 201
- Rye-straw in plaster work, 28
- SALTER, G., & Co.'s testing machine, 60
 Sand, 52
 Sand and cement, 462: Arnold's, 53: coloured, 100: for plaster work, 444: for German Portland cement, 188: silver, 53: substitutes for, 52: weights, 557
- Saracenic plaster work, 420
- Scagliola, 407

- Scagliola at the Albert Hall, 409; Buckingham Palace, 407; the Duke of Sutherland's House, 408; Hill Head, 408; Northumberland House, 408; the Reform Club, 407; Whitehall, London, 408
- .. Bellman, Ivey, & Carter, works in, 408, 410
- .. cheaper than painted work, 409
- .. colours and quantities for, 414
- .. columns, 411, 412
- joints of, 412
- .. compared with painted work, 409
- .. done *in situ*, 407, 411
- .. drying, 416; fixing, 408; floors, 408
- .. Guido Sassi, supposed inventor of, 407
- .. importance of chopping, 413
- .. in France, 407; in Italy, 407
- .. lasting properties of, 409
- .. manufacture of, 410-413
- .. materials for, 410-412
- .. mixing, 413-415
- light and dark, 413, 415
- .. on slate slabs, 408
- .. one of the most beautiful parts of plaster work, 409
- .. plain and rich mixing, 413, 415
- .. polish, equal to real marble, 416
- .. polishing, 415
- .. strong water for, 413
- .. the most profitable part of, 408
- .. uses of, 407, 409
- .. vases, turning, 412; veining for, 413
- Scale of diameter, 529
- .. minutes, 530
- Seasoning originals, 321
- Selenitic, 79; cement, 79; clay finish, 80; weights of, 557
- Setting, 97; coloured, 99; and hardening of hydraulic limes, 45
- Sgraffitto, 211
- .. an economical decoration, 212, 214
- .. and gilding, 212
- Portland cement façades, 189
- .. at Pompeii, 6; at South Kensington, 211
- .. colour solution for, 513
- .. colours for, 212
- .. combined with fresco, 213
- .. derivation of the word, 211
- .. designs for borders in, 220, 221
- .. durable decoration, 212, 214
- .. frieze from Florence, 212
- Rome, 213
- .. Heywood Summer's method of working, 214
- .. in three colours, 216
- and shading tints, 219
- .. in two colours, 212
- Sgraffitto panels, the four seasons, by G. T. Robinson, 214
- .. retable, by G. T. Robinson, 215
- .. Robinson's, G. T., method of working, 212
- .. slabs, 377
- .. used by prehistoric man, 211
- .. Vasari's method of working, 212
- Shakespeare on plasterers and plaster work, 28
- Shellac, to make, 321
- .. varnish, 331
- Sheppey cement, manufacture of, 74
- Siddons, Sarah, Queen of Tragedy and modeller, 334
- Silicate cotton, Anderson & Son's, 373
- covering capacity of, 556
- for fibrous plaster slabs, 372
- sanitary properties, 372
- Sirapite, 81; covering capacity, 555
- Skirtings, 100
- Slabs of *tectorium* at South Kensington Museum, 102
- from Pompeii, 102
- Slag as a fireproof aggregate, 464
- .. cement, 72
- fineness of, 73
- manufacture of, 72
- tensile strength of, Table, 73
- .. wool for concrete floors, 500
- Smeaton's discovery of the setting of limes, 80
- .. experience in mortars, 44
- Smith's metal, 360, 398, 406
- Solid work, meaning of the term, 579
- Soffit enrichment, mitre of, 308
- .. in the naturalistic style, 257, 327
- Soffits of arches from Rome, 437
- Spanish and Moorish plaster work, 428
- .. plaster work, 431
- Splayed angle mouldings, to run, 315
- Squaring dimensions, 560-563
- Squeezing in clay, 262; mouldings, 536; wax, 251
- Stage properties in fibrous plaster, 344, 345
- papier-mâché, 393
- Stalactite, 428; cornice, 422; domes, 425, 427; pendants, 428
- Stamped concrete, 475
- .. decorative plaster, 177, 230, 412, 438
- Stamps for gesso, 401; for names, 481
- Stearate of lime, 54
- Stearic, soap, and suet solutions, 279
- Steatite in plaster work, 433
- Steps, Patent non-slippery, 516.
- Stiffening rules, 336, 342
- Straight and circular casts out of one mould, 339
- Street, G. E., on Moorish plaster work, 430
- Stucco, *alburium* or *album opus*, 101
- .. ancient Greek, 1; ancient method of using, 4

- Stucco and brick dust *versus* terra cotta, 8
 reeds, 102; Austrian, 446
 .. at Chenni Concha, South America, 103; Constantinople, 102; Florence, 8; Fontainebleau, 13; Haddon Hall, 31; Hardwick Hall, 31; Holyrood Palace, 32; Nonsuch, 13; Peru, 103; Pompeii, 6; Raphael's house (1513), 9; Rome, 5; Rouen, 438; South Kensington Museum, 8; Venice, 103; the Palazzo Papadopoli, 103; the Temple of Apollo, 2
 .. bastard, 104
 .. busts in South Kensington Museum, 9
 .. by Donatello, 8; Lombardi, 9; Michael Angelo, 9; Primaticcio, 12; Romano, 10, 12; Sansovino, 9, 10; Udine, 9, 10; Vasari, 11; Vittorio, 10; Voller, 11
 .. chimney-pieces, 12, 16, 438
 .. coloured, 104, 123
 preserved with wax and oil, 102
 .. common, 103; difference between plaster and, 102; duro, 438; for modelling figures, 8; Italian, 437; *koniama* and *kalachrisis*, 102; London, 103; mixed with beer, milk, eggs, &c., 102; old, 101; pin point, 420; Pliny on, 2; primary cause of decay in, 45; Raphael's discovery of, 9
 .. recipes for, 2, 4, 8, 12, 101, 103
 .. rough, 103; slabs as mirrors, 4, 102; staining, 104; statue of Bacchus in coloured, 3; statues, 8, 9; trowelled, 104
- Styles of English architecture, 574
- Sugar in mortar, 432
 .. solution for jelly moulds, 285
- Sulphate of zinc for jelly moulds and plaster, 331
- Sulphur moulds, 398
- Superficial yards rendered with Portland cement gauged with various proportions of sand and in various thicknesses, 557
- T**ALC in plaster work, 432
 Technical training, use of, 551
- Tectorium*, marble plaster, 101
- Templates, cast, 171
 .. constructing, without a radius, 517
 .. fibrous plaster, 169
 .. for circular pediments, 197
 fascia angles, 177
 flat arches, 516
 Gothic rib mouldings, 143
 running elliptical mouldings, 168
 .. jack, 143; plasterers', 545
- Tenacity of concrete, 457
- Tensile strength of clean and dirty aggregates, 461
- Tensile strength of coarse and fine sands, 462
 hydraulic lime, 40
 Portland cement and sand, 463
 meaning of, 579
- Terra-cotta, antiquity, of, 450
 .. at Cubitt & Co.'s, 451, 455; Doulton's, 451; Fulham Pottery, 451; Etruria, Staffordshire, 451; the Albert Hall, 452; the National History Museum, 452
 .. by Bacon, Conde, Flaxman, Rhœcus, Tinworth, Wedgwood, 451
 .. casting, 454; clay for, 451
 .. collection of art works in, 451
 .. drawing for, 452; drying, 454; durability of, 450; finishing, 453; firing, 454; fixing, 455
 .. geometry useful for, 452
 .. Homer on, 450
 .. importance of checking measurements of models, 453
 .. kilns for, 454
 .. meaning of the word, 450
 .. mitres in, 454
 .. model making, 452; modelling for, 452; moulding for, 453; pressing, 453
 .. quantity of water for one ton of, 455
 .. setting out, 452, 453
 .. shrinkage, rule for, 453
 .. the potter's wheel, 450
 .. three methods for producing, 451
 .. trade, 455
 .. vases, ancient, 450, 451
 worth their weight in gold, 450
 .. work, 451
- Testing coarse stuff, 44, 90
 .. concrete steps, 487; gelatine, 318; glue, 318; machines, 59; plaster, 37; Portland cement, 56, 60-63, 69, 71
- Tests of various sands and cements, 463
- Texture in modelling, 227
- The modeller's art, 228
 .. Worshipful Company of Plasterers, 547
- Thickness rules, 291, 540
- Tile cleaning, 516; cutting, 516; fixing, 515
- Timber quantities, 559
 .. terms, 558
- Tinworth, G., modeller, 226, 451
- Torus, to describe the, 523
- Toto, A., wax modeller, 13
- Tow for fixing, 364, 367
 .. in Egyptian plaster work, 422; in plaster, 441; modelling, 247; rims of fibrous plaster casts, 349
- Tracing paper for moulds, 560

- Frammel centre, use of, 176
 Frammels for diminished columns, 149
 .. elliptical mouldings, 166
 .. making, 167, 169
 Transferring designs, 215, 219, 222
 Transition, meaning of the term, 574
 Frass and mortar, 44
 Frefoil, to describe, 521
 Friglyphs, position and use of, 528
 .. setting out and constructing, 194-196
 Frowelling, a knowledge of materials useful for, 473
 .. concrete, 473
 .. perfection attained by practice, 473
 .. soft stuff, a waste of time, 473
 .. stiff stuff, a waste of time, 473
 Frowelled Portland cement, 189
 Truss, to draw a, 290
 .. make a model of a, 290
 Turkish plaster work, 424
 Turnbats, 232, 266
 Turning columns and vases, 412
 Tuscan archivolt mouldings, 533
 .. capital, to make a, 300
 .. impost mouldings, 533
 .. order, the, 529
 Tympani, 191, 201
 Tyzack's trowels, 545
- UNDERCUTTING** casts by hand, beauty of, 328
 .. fibrous plaster, 353
 Unskilled labour, evil effects of, 368
 Utilisation of waste products, 462
- VALUE** of plaster work, 559
 Vase, to plaster piece-mould a, 274
 Venus of Milo, the, 226
 Vermiculation, 200
 Verrochin, A., and piece moulding, 9
 Victoria Stone Co., the pioneers of concrete slabs, 480
 Vitruvius on damp walls, 4; lathing, 4; modelled plaster work, 4; old stucco, 101; polished plaster, 4
 Voids in aggregates, 464
 Volute, definition of, 579
- WARE**, Isaac, on plaster ceilings, 21
 Waste moulding a bust, 262
 Waste moulding for undercut mouldings, 286
 .. in plaster, 262
 .. wax moulding, 253
 Water for concrete, 405
 .. bad concrete caused by excess of, 490
 .. bulk absorbed, Table, 480
 .. gives birth to the strength of concrete, 466
 .. measurements, 558
 .. seasoned plaster moulds, 285
 Waterproof centring, advantages of, 489
 Wattle and daub, 14, 31
 Watt's plaster models at Eaton Hall, 235
 Wax casting, 251; cleaning, 252; covering capacity of, 556; dissolving, 252; modelling, 246; moulding piece, 261; pots, 252; squeezing, 251; waste moulds, 253
 .. moulds, chasing, 261; framed, 359, 363; furred, 284; jointed, 252; oiling, 280; skin, 253
 .. moulding, 252; a Corinthian capital, 299; and plaster pieces, 359; bled moulds facilitates casting, 253; fibrous plaster centre flowers, 350-352; fibrous plaster enrichments, 359, 363; front, 254; method of pouring on wax, 253, 260; open front, 255; piece, 261; plaques, 261; surface, 257
 Webb, S., on ceiling decoration, 243
 Weak laths, cause of cracks in plaster, 110
 Weatherell, J., ornamental plasterer, 19
 Weights of concrete having various aggregates, Table, 557
 .. various plastic materials, Table, 558
 Wellings, J., on haired setting, 51
 Westmacott's patent lime mortar, 64
 White cements, 104
 .. casting, 284
 .. for concrete panelled ceilings, 499
 .. setting concrete, 494
 .. sanitary and fire-resisting, 104
 Whitewash, brilliant, 570; cheap, 570; covering capacity of, 556; fire proof, 570; mould-proof, 571; sanitary, 570; washable, 571
 Whitewashers' wages (in A.D. 1212), 24
 Williams Brothers & Co.'s mosaic, 483
 Williams, C., stucco worker (1547), 15, 30
 Wilkes and Millar's fibrous slabs, 65
 .. patent paving, 469
 Wilkinson, W. B., introducer of concrete paving, 459
 Wilkinson, W. B., & Co.'s work at Newcastle-on-Tyne, 478
 Willows in plaster work, 422
 Willoughby, one of the old school of plasterers, 238
 Wilton, plasterer and sculptor, 34
 Window apron, to form with template, 209
 .. heads, to construct, 208
 Windows, setting out, 207
 Wren, Sir C., on plaster work, 18, 33, 103
 Wyatt's, Sir Digby, method of judging effects of enrichments, 228
- YOUNG**, B., & Co.'s Ar gelatine, 317
- ZERO**, definition of, 579

DANVILLE ASBESTIC PLASTER

See Notice, Page 78 in this Book.

FIRE - SOUND - CRACK - STAIN
PROOF.

Can be papered, painted, or decorated upon, without risk, at once.

Nails can be driven into it as into a pine board; no plugs needed; Mouldings can be nailed to it (see case of Carlton Hotel).

It takes a surface equal to any known Plaster.

Being a non-conductor, buildings plastered with it are warmer in winter and cooler in summer (see case of Mount Nelson Hotel at Cape Town, built for Messrs. Donald Currie & Co., by Wm. Cubitt & Co.)

No Repairs, as, being fibrous, it cannot crack or fall off.

Always an advantage to be able to finish a building quickly as regards painting, papering, distempering, or decorating.

Architects, please specify as follows:—

“The Plastering to be executed with DANVILLE ASBESTIC PLASTER, by the Danville Asbestic Plastering Co.

“Plasterers' Bills priced and all information given at their offices, 27, Billiter Buildings, Leadenhall Street, London, E.C.”

For further particulars apply to

The Asbestic Manager,

The Asbestos & Asbestic Co., Ltd.,

27, Billiter Buildings, Leadenhall Street,

London, E.C.

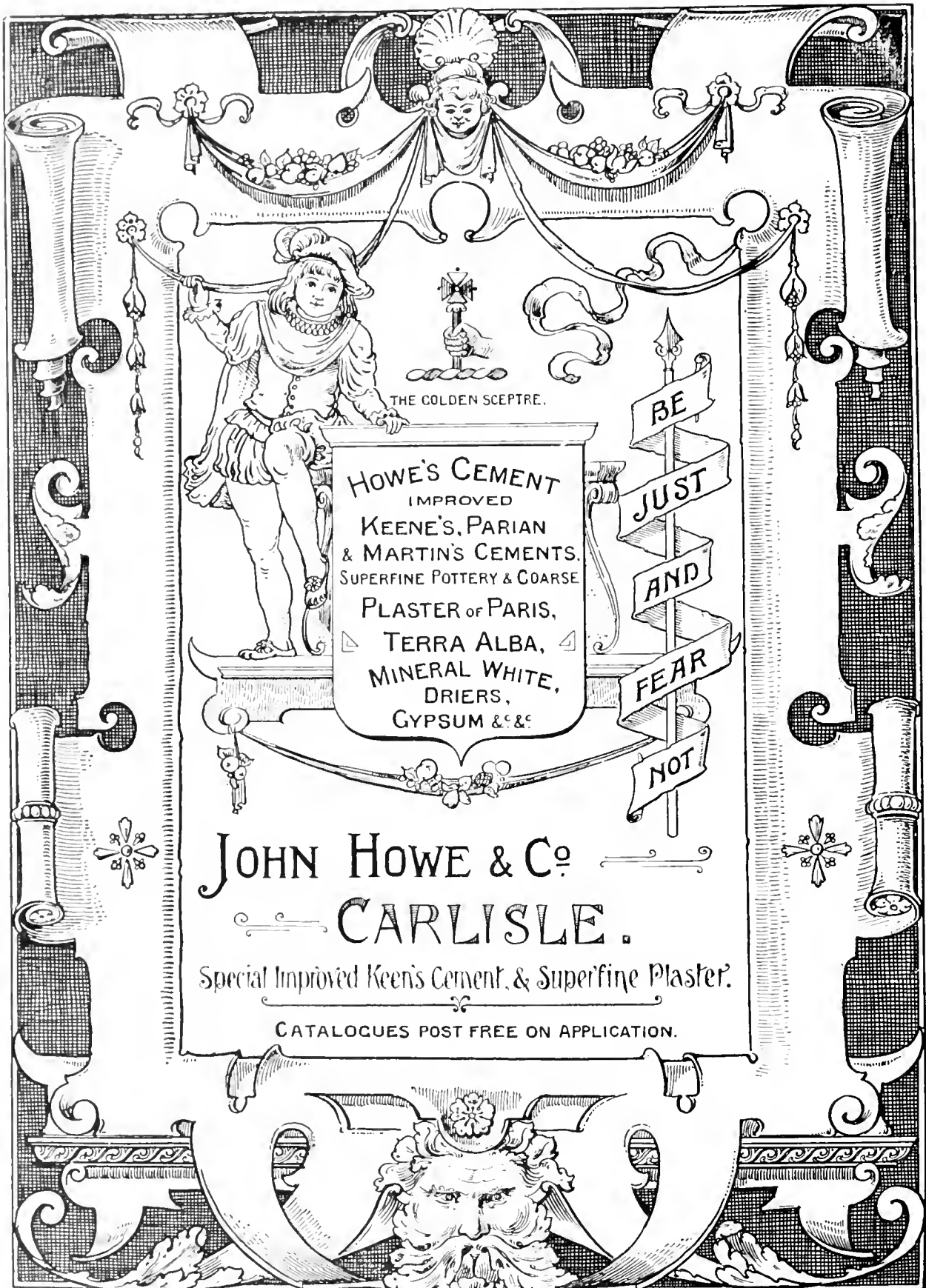

THE GOLDEN SCEPTRE.

HOWE'S CEMENT
 IMPROVED
 KEENE'S, PARIAN
 & MARTIN'S CEMENTS.
 SUPERFINE POTTERY & COARSE
 PLASTER OF PARIS,
 TERRA ALBA,
 MINERAL WHITE,
 DRIERS,
 GYPSUM & C^o

BE
 JUST
 AND
 FEAR
 NOT

JOHN HOWE & C^o
 CARLISLE.

Special Improved Keen's Cement, & Superfine Plaster.

CATALOGUES POST FREE ON APPLICATION.

*Supplied for 35 Years to the Science and Art Department of
Her Majesty's Government.*



CAFFERATA & CO.

NEWARK-ON-TRENT.

MANUFACTURERS OF

PLASTER OF PARIS, KEENE'S
AND PARIAN CEMENTS

IN ALL QUALITIES.

Established over 40 Years.

Largest Manufacturers in the Kingdom.



The uniform excellence of the quality of the Goods made by us has secured for our Manufactures a considerable and widespread reputation. We may mention that out of the last **Half-a-Million Tons** sent from our works, a quantity representing **Five Million Sacks**, not one Sack has been returned as deficient in quality.

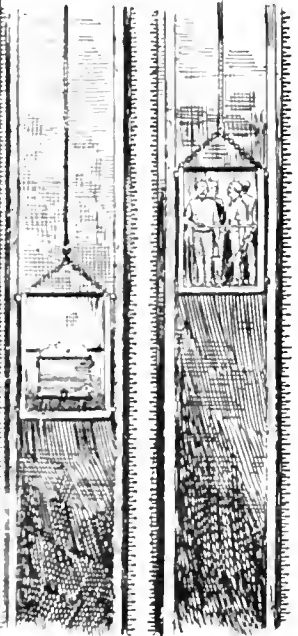
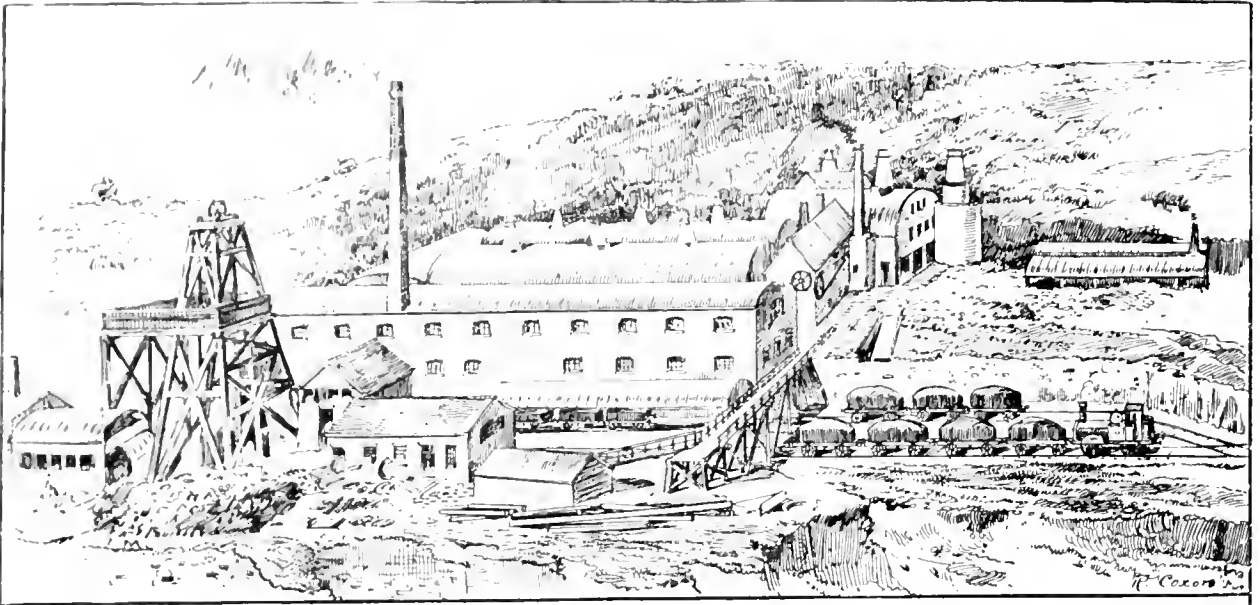

THE SUBWEALDEN GYPSUM COMPANY, LIMITED.

ESTABLISHED 1876.

Gypsum Mine Owners, Plaster & Cement Manufacturers, &c.

Sole Proprietors and Manufacturers of
SIRAPITE PLASTERING.

COARSE AND FINE PLASTER. KEENE'S AND PARIAN CEMENTS.
FIBROUS PLASTER SLABS FOR RAPID PLASTERING.
GROUND GYPSUM FOR MANURE, &c.

Mines, Works and Offices:—MOUNTFIELD, ROBERTSBRIDGE, SUSSEX.

Address for Goods and Returned Sacks:—BATTLE STATION, S.E.Ry.

Telegrams to—"GYPSUM, ROBERTSBRIDGE STATION."



Telegraphic Addresses: "Robinson, Carlisle"; "Stucco, London."

Telephone 1025.

Gold Medal**London, 1889.**

Established 1828.

CONTRACTORS TO H.M. HOME AND COLONIAL GOVERNMENTS:
War Office: Admiralty: G.P.O., Etc.

ROBINSON'S CEMENT

(Registered Trade Mark),

1885.



**ROBINSON'S
SIMPLEX PARTITION
BLOCKS,**
1895.

**ROBINSON'S
PATENT FIRE-PROOF & HYDRAULIC CEMENTS.**
(BY ROYAL LETTERS PATENT.)

Robinson's "Simplex" and "Stucco" Fire & Sound Proof Partition Blocks.
(PROTECTED UNDER THE PATENT ACTS.)

Manufactured by the Patentees,

JOSEPH ROBINSON & Co., LTD.
Alabaster Proprietors.

Lessees of the Alabaster of the Duke of Devonshire, Earl of Lonsdale, St. Bees' School Commissioners, etc., etc.

MANUFACTURERS OF

PLASTER OF PARIS

For all purposes, and of very Superior Quality.

KEENE'S, PARIAN, & MARTIN'S CEMENTS,
Also **BEST LONDON PORTLAND CEMENT** supplied from Brewery Wharf, Greenwich.

SIR EYRE M. SHAW'S Testimony on Robinson's Cement.

LONDON FIRE BRIGADE, SOUTHWARK, S.E.

I am of opinion that this Cement would be much more effectual in preventing the spread of fire than any other of the common Plasters or Cements generally used in this country.

Messrs. JOSEPH ROBINSON & Co., Ltd.

EYRE M. SHAW.

Works:—Knothill, nr. Carlisle; Kirkbythore, Westmoreland; Whitehaven, Cumberland.

Head Offices: - - - CARLISLE.

London Offices:

BREWERY WHARF, BRIDGE ST., GREENWICH, S.E.

London Wharf and Works:—Creek Bridge, Deptford, S.E.

London Railway Depot:—Somers Town Goods Station, Midland Railway, N.W.

(Entrances Euston and Midland Roads.)

Special facilities for Export from London (Steamers can Load alongside Brewery Wharf).
Prices, Samples, and Full Particulars on Application.

JOHN RULE
 PLASTERER, ARCHITECTURAL MODELLER.
 Fibrous Plaster Worker,
 Lathwood Importer and Lathrender,
 Granolithic Pavement and Floors,
 Fireproof Floors and Artificial Stonework,
 Granite Cement Slabs for worn Steps a speciality.

WORKS AND OFFICES. **WEST STREET,**
SUNDERLAND.

ESTABLISHED 1830

NATIONAL
 TELEPHONE
 No 706

JOSEPH BICKLEY,

62, Lillie Road, West Brompton, London, S.W.

(Near Lillie Bridge.)

ARCHITECTURAL MODELLER,

PLASTERER AND CONTRACTOR.

MANUFACTURER OF

Plaster and Canvas Enriched Ceilings, Gallery Fronts, &c.

FIRE-PROOF PLASTER SLABS AND PUGGING.

METALLIC AND GRANITE-CONCRETE PAVING AND FLOORS.

Concrete Dressing, Steps, &c.

Patent 'Mineral Black' Covering to Walls of Tennis & Racquet Courts.

ALWAYS A DRY COURT.

"BRIGHT COLOUR." ROUGH CAST.

ADIE'S Cement Testing Machine.

WITH AUTOMATIC SPEED REGULATOR.

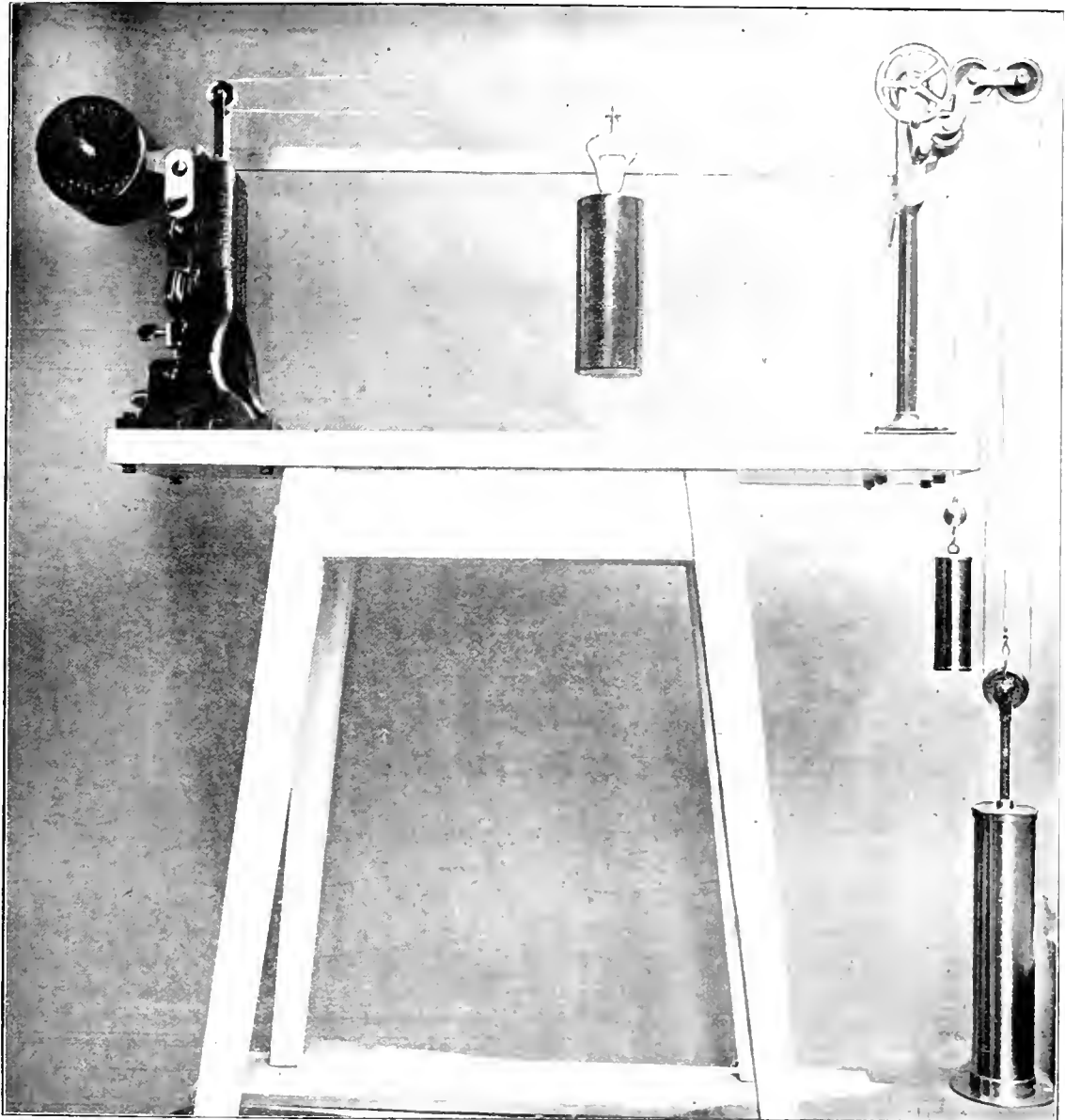

FOR PARTICULARS APPLY TO
PATRICK ADIE,
Broadway Works,
1, BROADWAY, WESTMINSTER, S.W.

GEO. SALTER & CO.

WEST BROMWICH,

PATENTEES AND MANUFACTURERS.

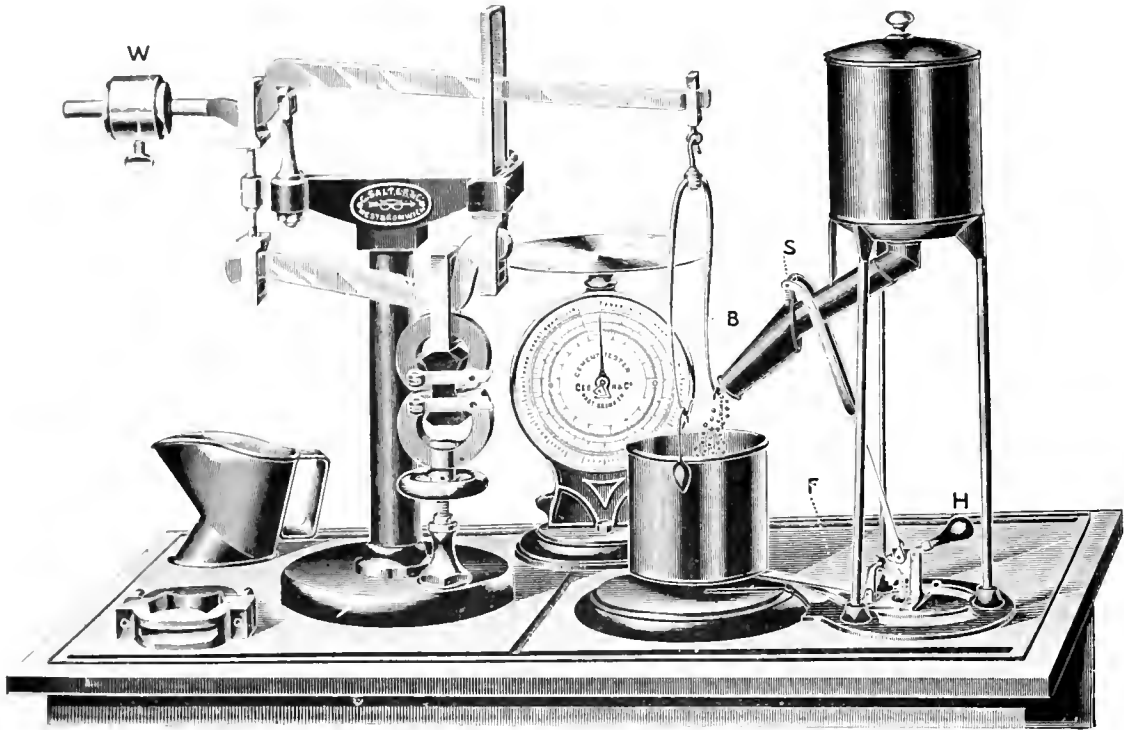

MAKERS OF

KUHLMANN'S IMPROVED CEMENT TESTER

As supplied to the BRITISH GOVERNMENT, MUNICIPAL and other CORPORATIONS, many of the leading Contractors, &c. &c.

PRICE LISTS AND TESTIMONIALS ON APPLICATION.

SPRINGS for BALL-ROOM FLOORS.

Automatic Door Locks.

Wire Hat and Coat Hooks.

Patent Machine-made Gas and Water Pipe Hooks.

Patent Door Springs.

PATENT INDURATED STONE.

Patent Indurated Slab Paving.

Made by Machinery, and hardened by the Company's Special Chemical Processes.

Thoroughly matured Slabs, 4/- per yard sup. at Works. Crushing Strain at Three Months, 7,134 lbs. per cubic inch.

Concrete Sanitary Tubes.

In Two Feet lengths.

<i>Sizes :</i>	15 in.	18 in.	21 in.	24 in.	30 in.	36 in.
<i>Per foot :</i>	1/8½	2/8	3/7	4/8	6/2	8 2

Tests for Porosity.

Made by Messrs. KIRKALDY & SON, show an absorption of only 1.75 by weight.

Patent In Situ Paving.

Laid in various thicknesses, according to traffic. The best, cheapest, and most durable paving for Stables, Yards, School Playgrounds and Corridors, Warehouses, etc., etc.

Staircases

Built In Situ; and all kinds of Window Sills and Heads and other Architectural Work kept in Stock or made to pattern.

MANUFACTURED BY THE

Patent Indurated Stone Co., Ltd.

OFFICES, WORKS, and SIDINGS:

MILLWALL, LONDON, E.

Telegrams—"PETRIFY, LONDON."

A.

National Telephone
675 King's Cross.

Telegrams—
"Slagwool, London."



FRED JONES & CO.

(Formerly R. W. HITCHINS & Co.)

MANUFACTURERS OF

FIBROUS AND OTHER PLASTER SLABS.

SILICATE COTTON WORKS, KENTISH TOWN,
LONDON, N.W.

Telegraphic Address—"Glue, London."

Telephone No. 724 Hop.

YOUNG'S GELATINE,

SPECIALLY MANUFACTURED FOR

Moulding Undercut Models,
For Casting Plaster & Cement Work.

Wholesale from

B. YOUNG & CO., SPA ROAD, BERMONDSEY, S.E.

RETAIL OF ALL DEALERS.

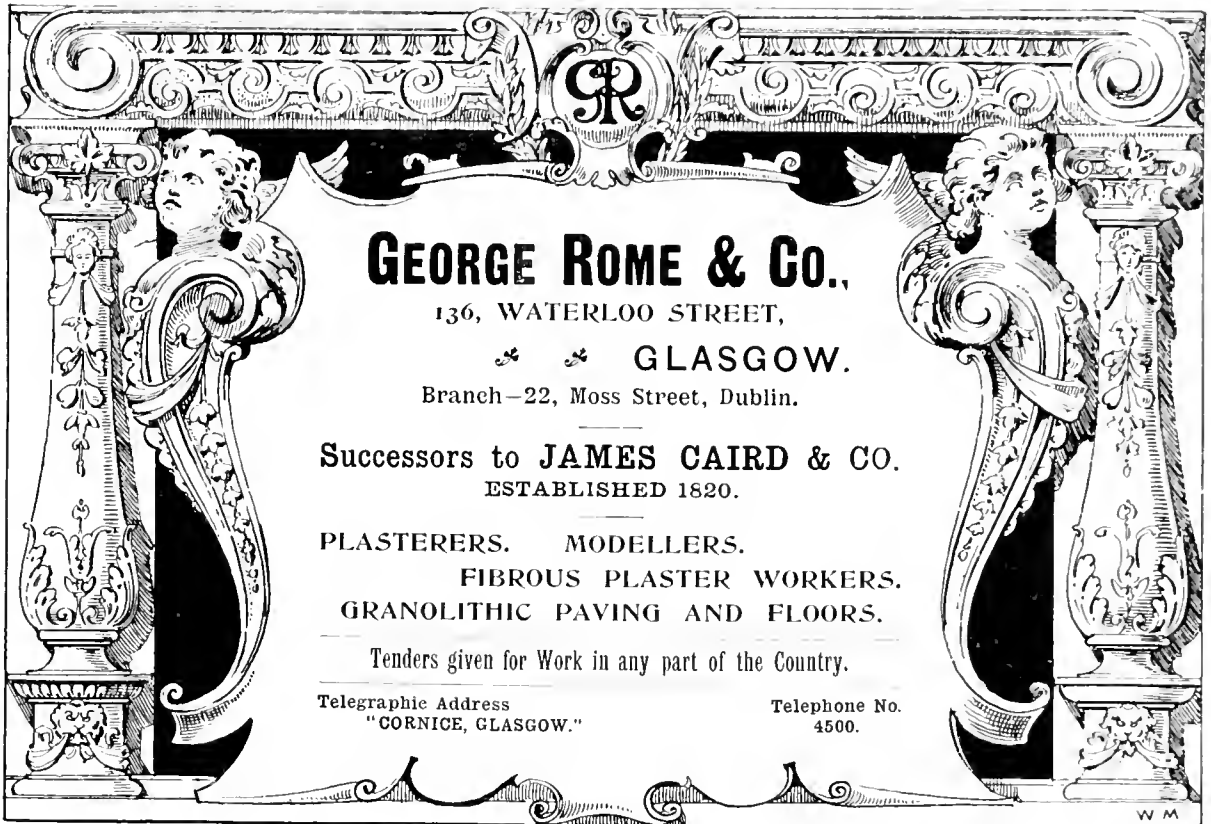

GEORGE ROME & Co.,
 136, WATERLOO STREET,
 GLASGOW.
 Branch—22, Moss Street, Dublin.

Successors to **JAMES CAIRD & CO.**
 ESTABLISHED 1820.

PLASTERERS. MODELLERS.
 FIBROUS PLASTER WORKERS.
 GRANOLITHIC PAVING AND FLOORS.

Tenders given for Work in any part of the Country.

Telegraphic Address "CORNICIE, GLASGOW." Telephone No. 4500.

W M



BY ROYAL LETTERS PATENT, No. 7855.

ARTISTIC
PATENT PLASTER DECORATIONS.

It is the only Patent Decoration with
 the undercut Relief.

Fire-proof, Damp-proof, as far as any material is capable of resistance to Fire or Damp.

If Screwed to any surface can be removed.

Sanitary! The Cleanest and Healthiest Material. Being solid surface and adhered without paste, glue, &c.

All kinds of Architects' Designs Executed.

*A Book of Designs, with Price List and
 Scale of Measurements, will be sent Free to any address in the
 United Kingdom on application.*

THE MURAL & DECORATIONS SYNDICATE, LTD.
 50, Milton Street, London, E.C.

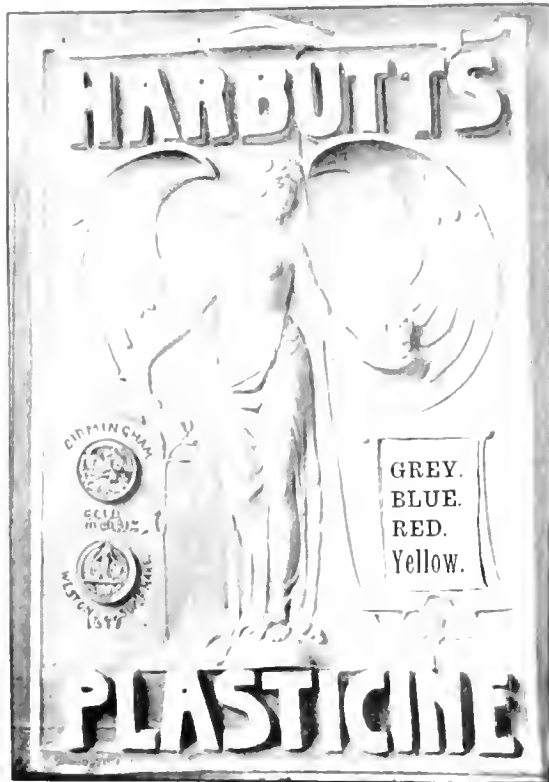

HARBUTT'S PLASTICINE

For Fine Art and Architectural
MODELLING.

CLEAN! EVER PLASTIC! INDESTRUCTIBLE!

Does not shrink; not affected by water; and admits of
Gelatine Moulds.

Pronounced by leading Decorators and Sculptors to be
the **Best** and **Cheapest** Modelling Material in the
market, and greatly superior to Greasy Foreign Pastes.

Made of Soft or Medium consistency.

A Specimen Pound Box (Grey) Post Free, 1s. 7d.

A Liberal Discount to Purchasers in bulk

"I find your 'Plasticine' excellent."—ED. LAUTERI.

"I like 'Plasticine' very much—it is admirable."—
F. E. E. SCHENCK.

WM. HARBUTT, A.R.C.A., Hartley House, Bath.

IMPORTANT TO PLASTERERS AND OTHERS.

PURE MANILLA FIBRE

A Perfect & Superior Substitute for Ox-Hair.

ADVANTAGES:

- Guaranteed not to rot or fall away when exposed to the weather, as Hair does.
- More economical and more efficient than ordinary Plasterers' Hair.
- Half the quantity of "Manilla Fibre" is required as compared with ox-hair.
- It is longer and more uniform in length than ox-hair, and consequently a superior binder.
- It is clean and free from dust and other foreign matters.

The following Unsolicited Letters will show how highly this Material is esteemed by leading Plasterers:—

7, 30 and 41, SUMMER STREET, ABERDEEN.

We have always found it give greater satisfaction in every way than the ordinary plasterers' hair. It likewise takes a considerable less quantity of Fibre to a batch of lime than the hair, and does not rot in the lime it exposed to wet, as hair does. We have used it on most of the largest contracts in Aberdeen, such as the Royal Infirmary, Asylum, Garden Bay Hotel, &c., &c.

It may be worthy of note, that the leading Architects specify "MANILLA FIBRE" in their schedules, as they prefer it far better than hair.

To ourselves and to all our clients it has given the utmost satisfaction.

(Signed) ROGER & BAXTER.

189, BELMONT STREET, ABERDEEN.

"Pop," or MANILLA FIBRE, is an article now entirely taking the place of hair in this district, and its advantages are apparent.

JAMES BANSOCHIE & SONS,

Plasterers and Cement Workers

55, JOHN STREET, ABERDEEN.

We have great pleasure in certifying that we have used MANILLA FIBRE and find it to be much more profitable, as it only takes about one-half quantity of MANILLA to a batch of lime to that of hair, and does not rot in lime when exposed to the weather.

MANILLA is now used in the erection of all the principal buildings, and Architects specify this material to be used instead of hair.

(Signed) JAMES SCOTT & SON,
Contractors, Plasterers, and Cement Workers.

148a & 150, HUTCHISON STREET WEST, ABERDEEN.

We certify that we have used MANILLA FIBRE, as manufactured by you, for the last 12 months, and have found it very satisfactory, more so than the ordinary plasterers' hair, and not so liable to rot, and goes as far as 1½ of the hair.

(Signed) STEPHEN & GIBB,
Plasterers and Cement Workers.

MANILLA FIBRE is also specially recommended by JOHN RUST, Esq., City Architect; and is specified by A. MARSHALL MACKENZIE, Esq., Messrs. BROWN & WATT, ARTHUR CLYNE, Esq., and other eminent Architects.

Full Particulars, Samples, and Prices Free on application to the Sole Maker,

JOHN HALL, Aberdeen Rope Works, Footdee Links, ABERDEEN.



W. G. DREW,

Late T. Drew & Son,

PLAIN AND ORNAMENTAL PLASTERER,

AND

FIBROUS PLASTER MANUFACTURER,

68, Richmond Road, Islington, London, N.

F. DE JONG & CO.

MODELLERS AND MANUFACTURERS OF

Ornamental Fibrous Plaster and Carton-Pierre.
DECORATIVE PAINTERS & DESIGNERS.

Offices and Works:

84, ALBERT STREET, CAMDEN TOWN, LONDON, N.W.

NELSON'S GELATINE

FOR

MOULDING AND PLASTERER'S WORK.

Nelson's Photographic Gelatine.

Retail from all Dealers. Wholesale only from the Manufacturers,

GEO. NELSON, DALE & CO., Limited, 14, Dowgate Hill, London, E.C.

A. F. LATTO & CO.

112, 113, Fore Street, London, E.C.

JUTE, HEMP, AND FLAX MERCHANTS.

SPECIALTY—CANVAS

Of all Descriptions for Fibrous-Plastering, Building, Paper-Hanging, &c.
 Samples and Price Lists on Application.

Telegraphic Address "Yarnless, London."

TAR PAVING.

Clifton Mosaic Tile. Clifton Artificial Stone (IN SLABS OR
IN SITU.)

Cheap, Durable, and Non-Slippery, for Footpaths, Playgrounds, Warehouses, Corridors, Stables, Tennis Courts, Steps, Landings, &c., &c. Stone Moulded to any Design.

ASPHALTE MANUFACTURERS AND CONTRACTORS.

WORK GUARANTEED FOR LONG PERIODS.

A. C. W. HOBMAN & CO.,

Contractors to Her Majesty's Government, Sole Contractors to the London School Board, The London County Council, Metropolitan Asylums Board, Peabody Donation Trustees, and the principal Boards of Works round London and elsewhere.

CLIFTONVILLE, SOUTH BERMONDSEY, LONDON, S.E.

Telegraphic Address:—HOBMAN, SOUTH BERMONDSEY.

Telephone No. 1241 HOP.

ANTISEPTIC PLASTER FIBRE.

SUBSTITUTE FOR COW-HAIR.

More Effective, More Durable, More Economical than Cow-Hair.

Thoroughly Antiseptic. Free from all the Impurities of Hair.

Stronger and more reliable than Hair. Strength not impaired by action of Lime.

ROBERT BAXTER & CO.,

Manufacturers,

64 & 66, BELL STREET, DUNDEE.

PETER FORD & SONS,

MANUFACTURERS OF ALL KINDS OF

PLASTER of PARIS.

KEENE'S, PARIAN & MARTIN'S CEMENT.

ALABASTER AND STONE MERCHANTS.

Alabaster, White or Coloured, in Blocks for Architectural Purposes. Turned work of every description. Ornaments. Gypsum Stone for Rockeries, Vineries, &c. &c.

MINES AND MILLS—FAULD, NEAR TUTBURY
 STONE QUARRIES—ALTON & STANTON

NORTH STAFFORD RAILWAY.

Offices: BRIDGE STREET, UTTOXETER.

Telegrams "FORDS, UTTOXETER."
 National Telephone No. 2

Alabaster Blocks Quarried up to 14 feet in Length.

Alexr. Gilchrist,

Brassfounder,

28, EGLINTON STREET, GLASGOW,

Makes a Speciality of all kinds of Granolithic or Concrete.

Brass Pavement Rollers & Name-Plates.

Special Machinery for their Manufacture.

Stable Rollers & Grooves. Hand Stamps, Border Rollers and Crimpers.

PAVEMENT NAME-PLATES, ANY NAME & SIZE.

Suitable for Builders, Contractors, Plasterers, and Concrete Workers.

SEND FOR ILLUSTRATED LIST.

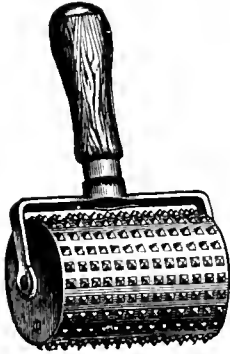

Teeth Cut out of Solid.

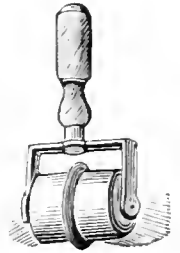

SAMUEL TYZACK,

RAILWAY ARCH, 343 & 345, OLD STREET, E.C.,

Manufacturer of Plasterers' Tools of all Descriptions.

TROWELS, SMALL TOOLS, JOINT RULES, ETC.

SAMUEL TYZACK'S

EDGE TOOL, FILE & CUTLERY WAREHOUSES

Steam Grinding Mills—343 & 345, OLD STREET, LONDON, E.C.

ART AND SCIENCE ARCHITECTURE BUILDING CONSTRUCTION DECORATION CRAFT AND EDUCATION

1^D WEEKLY THE ILLUSTRATED 6^D MONTHLY
CARPENTER AND BUILDER

Of interest to all concerned in the maintenance and construction of the house.
 ESTABLISHED 1877.
 Hundreds of testimonials from subscribers and advertisers

LONDON.
 YEARLY SUB. JOHN DICKS. SINGLE COPIES
 6/6 313 STRAND W.C. 1^D
 ALL NEWSAGENTS & BOOKSTALLS POST FREE

MASONS
 BRICKLAYERS
 CARPENTERS
 JOINERS
 SLATERS
 GLAZIERS
 GASFITTERS

PLASTERERS
 PAINTERS
 PLUMBERS
 CONCRETEERS
 PAVIMENTS
 ELECTRICIANS
 GARDENERS

ESTABLISHED OVER TWENTY YEARS. BEST MEDIUM FOR TRADE ADVERTISEMENTS.

WILLIAM MILLAR,
PLASTERER, MODELLER, AND CEMENT EXPERT.

Analysis made of Portland Cement, Limes, etc.

Specialities: MODELLING, FIBROUS PLASTER, SCAGLIOLA,
 SGRAFFITO, GESSO.

AGENT FOR

MANILLA FIBRE (a Perfect Substitute for Ox-Hair), Gelatine and Fibrous Plaster Materials.
 Moulding Pieces of Modern Enrichment Supplied to the Trade.

Postal Address: 94, HIGH HOLBORN, LONDON.

Practical Books for Plasterers, Builders, Decorators, etc.

Building Construction & Drawing.

FIRST STAGE, OR ELEMENTARY COURSE. By CHARLES F. MITCHELL. With 310 pp. and nearly 700 Illustrations, fully dimensioned. Fourth Edition (19th Thousand). Cr. 8vo, cloth, Price 3s. Net 2s. 6d.

Building Construction. ADVANCED AND HONOURS COURSES.

By CHARLES F. MITCHELL. Containing 552 pp. of Text, with over 280 Illustrations. Second Edition, Revised and Enlarged (7th Thousand). Cr. 8vo, cloth, Price 5s. 6d. Net 4s. 6d.

"So far as it is possible for any one to compile a satisfactory treatise on building construction, Mr. Mitchell has performed the task as well as it can be performed."—*The Builder*.

Quantities. A Text-Book explanatory of

the best methods adopted in the measurement of builders' work, and containing many useful hints and much valuable information. By Professor BANISTER FLETCHER, F.R.I.B.A. Sixth Edition, With 16 Folding Plates and numerous Illustrations in the text. Crown 8vo, cloth, Price 7s. 6d. Net 6s.

THE MOST COMPLETE, CONCISE, AND HANDY WORK ON THE SUBJECT.

Estimating. A Method of Pricing

Builders' Quantities for Competitive Work. By GEORGE STEPHENSON. Showing how to price, *without the use of a Price Book*, the Estimates of the work to be done in the various building trades. Third Edition, the Prices carefully revised to date. Crown 8vo, cloth, Price 6s. 6d. Net 5s. 6d.

Repairs: How to Measure and Value

them. By the Author of "Estimating." Second Edition, revised. Cr. 8vo, cloth, Price 3s. 6d. Net 3s.

The Conduct of Building Works

and the Duties of a Clerk of Works. By J. LEANING, F.S.I. Containing 140 pp. Small Crown 8vo, cloth, Price 2s. 6d. Net 2s.

Specifications. For the use of Builders,

Architects, and Surveyors. By J. LEANING, F.S.I. Second Edition, revised and enlarged. Crown 8vo, Price 4s. Net 3s. 4d.

Dictionary of Terms used in Build-

ing Construction and Architectural Design. Giving Practical Descriptions, with Technical Details. By R. S. BURN, Author of "The Guide to Masonry," &c. Containing nearly 300 pages of Text and 38 full-page Plates. Large 8vo, Price 5s. Net 4s.

House Drainage. By G. A. T. MIDDLETON,

A.R.I.B.A. and M.S.A., Author of "Stresses and Thrusts." Illustrated by 22 Plates and Diagrams. Second Edition, revised. Crown 8vo, cloth, Price 3s. 6d. Net 3s.

Stresses and Thrusts: By G. A. T.

MIDDLETON, A.R.I.B.A. Illustrated by 89 Diagrams. Crown 8vo, cloth, Price 5s. Net 4s.

Dangerous Structures, and how to

deal with them. A Handbook for Practical Men. By GEO. H. BLAGROVE. Crown 8vo, cloth, Price 3s. Net 2s. 6d.

Concrete: Its Use in Building. By

THOMAS POTTER. Second Edition, greatly enlarged. Crown 8vo, cloth, containing 500 pages of Text and 100 Illustrations. Price 7s. 6d. Net 6s. 6d.

A Handbook of Ornament. With 300

plates, containing about 3,000 Illustrations of the Elements and the Application of Decoration to objects. By F. S. MEYER. Third English Edition, Thick 8vo, cloth gilt, Price 12s. 6d. Net 9s. 6d.

"A LIBRARY, A MUSEUM, AN ENCYCLOPEDIA, AND AN ART SCHOOL IN ONE. To rival it as a book of reference one must fill a bookcase."—*The Studio*.

Any of the above Works will be forwarded POST FREE on receipt of the Cash Discount Prices Quoted.

B. T. BATSFORD, 94, High Holborn, London, W.C.

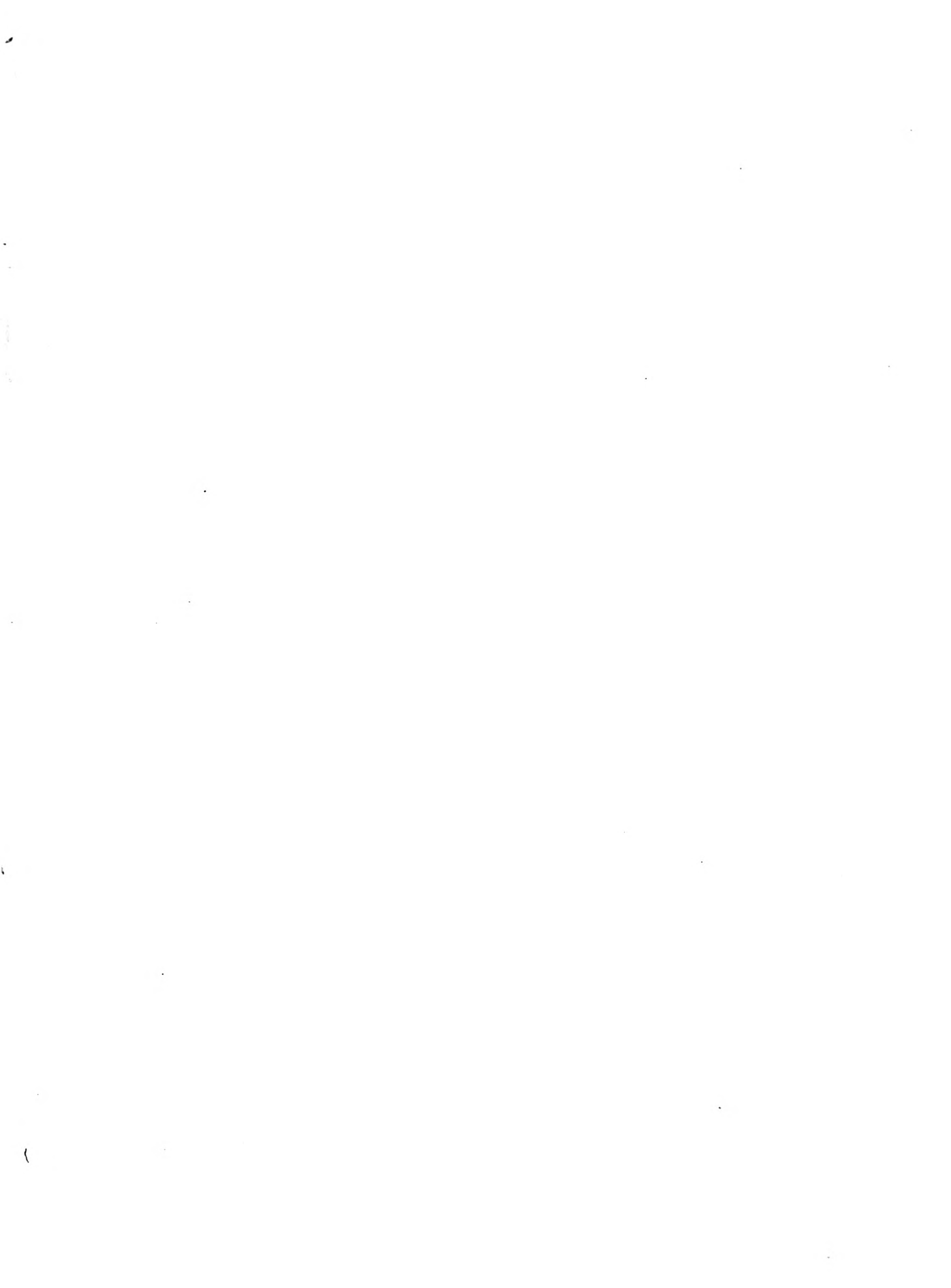

University of California
SOUTHERN REGIONAL LIBRARY FACILITY
405 Hilgard Avenue, Los Angeles, CA 90024-1388
Return this material to the library
from which it was borrowed.

NON-RENEWABLE

FEB 04 1993

DUE 2 WKS FROM DATE RECEIVED

UCLA-AUPL
* NA 3690 M61p 1899



L 005 859 831 9

UNIV. OF CALIF. LIBRARY, LOS ANGELES

UC SOUTHERN REGIONAL LIBRARY FACILITY



D 000 572 592 4

